



CLC **Genomics** Workbench

USER MANUAL

Manual for
CLC Genomics Workbench 10.0
Windows, Mac OS X and Linux

March 10, 2017

This software is for research purposes only.

QIAGEN Aarhus
Silkeborgvej 2
Prismet
DK-8000 Aarhus C
Denmark



Contents

I	Introduction	13
1	Introduction to <i>CLC Genomics Workbench</i>	14
1.1	Contact information	16
1.2	Download and installation	17
1.3	System requirements	19
1.4	Workbench Licenses	21
1.5	When the program is installed: Getting started	36
1.6	Plugins	37
1.7	Install	37
1.8	Uninstall	38
1.9	Network configuration	39
1.10	The format of the user manual	41
1.11	Latest improvements	41
II	Core Functionalities	43
2	User interface	44
2.1	View Area	45
2.2	Zoom and selection in View Area	54
2.3	Toolbox and Status Bar	57
2.4	Workspace	60
2.5	List of shortcuts	62
3	Data management and search	65
3.1	Navigation Area	66

3.2	Metadata	74
3.3	Working with tables	90
3.4	Customized attributes on data locations	93
3.5	Local search	98
4	User preferences and settings	105
4.1	General preferences	105
4.2	View preferences	106
4.3	Data preferences	109
4.4	Advanced preferences	109
4.5	Export/import of preferences	110
4.6	View settings for the Side Panel	111
5	Printing	114
5.1	Selecting which part of the view to print	115
5.2	Page setup	116
5.3	Print preview	117
6	Import/export of data and graphics	118
6.1	Standard import	119
6.2	Import tracks	121
6.3	Import high-throughput sequencing data	128
6.4	Import RNA spike-in controls	149
6.5	Data export	150
6.6	Export graphics to files	159
6.7	Export graph data points to a file	163
6.8	Copy/paste view output	165
7	Data download	166
7.1	Download reference genome data	166
7.2	GenBank search	170
7.3	Search for structures at NCBI	173
7.4	UniProt (Swiss-Prot/TrEMBL) search	176
7.5	SRA search	179

7.6	Sequence web info	183
8	Running tools, handling results and batching	186
8.1	Running tools	186
8.2	Handling results	188
8.3	Batch processing	189
9	Workflows	198
9.1	Creating a workflow	199
9.2	Distributing and installing workflows	218
9.3	Executing a workflow	226
9.4	Open copy of installed workflow	227
III	Basic sequence analysis	229
10	Viewing and editing sequences	230
10.1	View sequence	230
10.2	Circular DNA	239
10.3	Working with annotations	241
10.4	Element information	250
10.5	View as text	251
10.6	Sequence Lists	251
11	BLAST search	255
11.1	Running BLAST searches	256
11.2	Output from BLAST searches	264
11.3	Local BLAST databases	270
11.4	Manage BLAST databases	272
11.5	Bioinformatics explained: BLAST	274
12	3D Molecule Viewer	283
12.1	Importing molecule structure files	284
12.2	Viewing molecular structures in 3D	288
12.3	Customizing the visualization	290

12.4	Snapshots of the molecule visualization	299
12.5	Tools for linking sequence and structure	299
12.6	Protein structure alignment	303
13	General sequence analyses	308
13.1	Extract Annotations	308
13.2	Extract sequences	310
13.3	Shuffle sequence	312
13.4	Dot plots	314
13.5	Local complexity plot	323
13.6	Sequence statistics	324
13.7	Join sequences	331
13.8	Pattern discovery	332
13.9	Motif Search	334
13.10	Create motif list	339
14	Nucleotide analyses	341
14.1	Convert DNA to RNA	341
14.2	Convert RNA to DNA	342
14.3	Reverse complements of sequences	343
14.4	Reverse sequence	343
14.5	Translation of DNA or RNA to protein	344
14.6	Find open reading frames	346
15	Protein analyses	349
15.1	Signal peptide prediction	350
15.2	Protein charge	350
15.3	Transmembrane helix prediction	351
15.4	Antigenicity	351
15.5	Hydrophobicity	353
15.6	Pfam domain search	357
15.7	Secondary structure prediction	360
15.8	Protein report	361

15.9	Reverse translation from protein into DNA	363
15.10	Proteolytic cleavage detection	367
16	Primers	372
16.1	Primer design - an introduction	373
16.2	Setting parameters for primers and probes	375
16.3	Graphical display of primer information	378
16.4	Output from primer design	380
16.5	Standard PCR	381
16.6	Nested PCR	384
16.7	TaqMan	386
16.8	Sequencing primers	388
16.9	Alignment-based primer and probe design	388
16.10	Analyze primer properties	394
16.11	Find binding sites and create fragments	395
16.12	Order primers	399
17	Sequencing data analyses	401
17.1	Importing and viewing trace data	402
17.2	Trim sequences	403
17.3	Assemble sequences	406
17.4	Assemble sequences to reference	408
17.5	Sort sequences by name	411
17.6	Add sequences to an existing contig	414
17.7	View and edit contigs and read mappings	415
17.8	Reassemble contig	424
17.9	Secondary peak calling	425
18	Cloning and cutting	427
18.1	Molecular cloning	428
18.2	Gateway cloning	438
18.3	Restriction site analysis	447
18.4	Gel electrophoresis	460

18.5	Restriction enzyme lists	463
19	Sequence alignment	467
19.1	Create an alignment	468
19.2	View alignments	473
19.3	Edit alignments	477
19.4	Join alignments	480
19.5	Pairwise comparison	482
19.6	Bioinformatics explained: Multiple alignments	485
20	Phylogenetic trees	487
20.1	Phylogenetic tree features	487
20.2	Create Trees	489
20.3	Tree Settings	503
20.4	Metadata and phylogenetic trees	512
21	RNA structure	518
21.1	RNA secondary structure prediction	519
21.2	View and edit secondary structures	525
21.3	Evaluate structure hypothesis	533
21.4	Structure scanning plot	535
21.5	Bioinformatics explained: RNA structure prediction by minimum free energy minimization	537
IV	High-throughput sequencing	544
22	Trimming, multiplexing and sequencing quality control	545
22.1	Trim Sequences	545
22.2	Demultiplex reads	557
22.3	Sequencing data quality control	565
22.4	Merge overlapping pairs	569
23	Tracks	574
23.1	Track lists	576

23.2	Retrieving reference data tracks	585
23.3	Merging tracks	585
23.4	Converting data to tracks and back	585
23.5	Annotate and filter tracks	589
23.6	Filter Based on Overlap	593
23.7	Graphs	593
24	Read mapping	600
24.1	Map Reads to Reference	601
24.2	Mapping output	610
24.3	Mapping reports	623
24.4	Mapping SOLid reads in color space	632
24.5	Local realignment	637
24.6	Merge mapping results	644
24.7	Remove duplicate mapped reads	645
24.8	Extract consensus sequence	648
24.9	Sample reads	652
25	Resequencing	654
25.1	Create Statistics for Target Regions	656
25.2	InDels and Structural Variants	664
25.3	Coverage analysis	680
25.4	Variant Detectors - overview	683
25.5	Fixed Ploidy Variant Detection	688
25.6	Low Frequency Variant Detection	689
25.7	Basic Variant Detection	690
25.8	Variant Detectors - error model estimation	691
25.9	Variant Detectors - filters	691
25.10	Variant Detectors - the outputs	698
25.11	The Fixed Ploidy and Low Frequency variant callers: detailed descriptions	703
25.12	Variant data	711
25.13	Detailed information about overlapping paired reads	716
25.14	Annotate and filter variants	716

25.15 Comparing variants	722
25.16 Predicting functional consequences	729
25.17 Identify Known Mutations from Sample Mappings	750
26 RNA-Seq Analysis tools	756
26.1 RNA-Seq analysis	757
26.2 Create Combined RNA-Seq Report	780
26.3 Advanced RNA-Seq Tools	781
26.4 PCA for RNA-Seq	783
26.5 Differential Expression for RNA-Seq	787
26.6 Create Heat Map for RNA-Seq	793
26.7 Create Expression Browser	798
26.8 Create Venn Diagram for RNA-Seq	800
26.9 Gene Set Test	803
27 Microarray and Small RNA Analysis	806
27.1 Small RNA analysis	807
27.2 Experimental design	825
27.3 Working with tracks and experiments	837
27.4 Transformation and normalization	845
27.5 Quality control	849
27.6 Statistical analysis - identifying differential expression	863
27.7 Feature clustering	874
27.8 Annotation tests	882
27.9 General plots	888
28 De novo sequencing	895
28.1 <i>De novo</i> assembly	895
28.2 Map reads to contigs	915
29 Epigenomics	918
29.1 ChIP-Seq Analysis	918
29.2 Annotate with nearby gene information	924

V Appendix	926
A Use of multi-core computers	927
B Graph preferences	930
C BLAST databases	932
C.1 Peptide sequence databases	932
C.2 Nucleotide sequence databases	932
C.3 Adding more databases	933
D Proteolytic cleavage enzymes	935
E Restriction enzymes database configuration	937
F Technical information about modifying Gateway cloning sites	938
G IUPAC codes for amino acids	940
H IUPAC codes for nucleotides	941
I Formats for import and export	942
I.1 List of bioinformatic data formats	942
I.2 List of graphics data formats	950
J SAM/BAM export format specification	951
J.1 Flags	952
K Gene expression annotation files and microarray data formats	955
K.1 GEO (Gene Expression Omnibus)	955
K.2 Affymetrix GeneChip	958
K.3 Illumina BeadChip	960
K.4 Gene ontology annotation files	961
K.5 Generic expression and annotation data file formats	961
L Custom codon frequency tables	965
M Comparison of track comparison tools	966

Bibliography

968

VI Index

978

Part I

Introduction

Chapter 1

Introduction to *CLC Genomics Workbench*

Contents

1.1	Contact information	16
1.1.1	Contact for the <i>CLC Genomics Workbench</i>	16
1.1.2	New program feature request	16
1.1.3	Getting help	16
1.2	Download and installation	17
1.2.1	Program download	17
1.2.2	Installation on Microsoft Windows	17
1.2.3	Installation on Mac OS X	18
1.2.4	Installation on Linux with an installer	18
1.3	System requirements	19
1.3.1	Limitations on maximum number of cores	20
1.4	Workbench Licenses	21
1.4.1	Request an evaluation license	22
1.4.2	Download a license using a license order ID	24
1.4.3	Import a license from a file	27
1.4.4	Upgrade license	28
1.4.5	Configure license server connection	30
1.4.6	Download a static license on a non-networked machine	34
1.4.7	Limited mode	35
1.4.8	Start in safe mode	35
1.4.9	CLC Sequence Viewer vs. Workbenches	35
1.5	When the program is installed: Getting started	36
1.5.1	Quick start	36
1.5.2	Import of example data	37
1.6	Plugins	37
1.6.1	Installing plugins	37
1.7	Install	37
1.8	Uninstall	38
1.8.1	Uninstalling plugins	39
1.8.2	Updating plugins	39

1.9	Network configuration	39
1.10	The format of the user manual	41
1.11	Latest improvements	41

Welcome to *CLC Genomics Workbench 10.0* – a software package supporting your daily bioinformatics work.

We strongly encourage you to read this user manual in order to get the best possible basis for working with the software package.

This software is for research purposes only.

1.1 Contact information

1.1.1 Contact for the *CLC Genomics Workbench*

The *CLC Genomics Workbench* is developed by:

QIAGEN Aarhus
Silkeborgvej 2
Prismet
8000 Aarhus C
Denmark

<http://www.qiagenbioinformatics.com>

Email: AdvancedGenomicsSupport@qiagen.com

If you have questions or comments regarding the program, please contact the support team as described here: http://resources.qiagenbioinformatics.com/manuals/clcgenomicsworkbench/current/index.php?manual=Getting_help.html.

1.1.2 New program feature request

The QIAGEN Aarhus team is continuously improving the *CLC Genomics Workbench* with our users' interests in mind. We welcome all requests and feedback from users, as well as suggestions for new features or more general improvements to the program. To contact us via the Workbench, please go to the menu option:

Help | Contact Support

1.1.3 Getting help

Getting help via the workbench

If you encounter a problem or need help understanding how the *CLC Genomics Workbench* works, and the license you are using is covered by our Maintenance, Upgrades and Support (MUS) program (<https://www.clcbio.com/support/maintenance-support-program/>), you can contact our customer support via the Workbench by going to the menu option:

Help | Contact Support

This will open a dialog where you can enter your contact information, and a text field for writing the question or problem you have. On a second dialog you will be given the chance to attach screenshots or even small datasets that can help explain or troubleshoot the problem. When you send a support request this way, it will automatically include helpful technical information about your installation and your license information so that you do not have to look this up yourself. Our support staff will reply to you by email.

Other ways to contact the support team

You can also contact the support team by email: AdvancedGenomicsSupport@qiagen.com

Please provide your contact information, your license information, some technical information

about your installation , and describe the question or problem you have. You can also attach screenshots or even small data sets that can help explain or troubleshoot the problem.

Information about how to find your license information is included in the licenses section of our Frequently Asked Questions (FAQ) area: <https://secure.clcbio.com/helpspot/index.php?pg=kb>. Information about MUS cover on particular licenses can be found by <https://secure.clcbio.com/myclc/login>.

1.2 Download and installation

The *CLC Genomics Workbench* is developed for Windows, Mac OS X and Linux. The software for either platform can be downloaded from <http://www.clcbio.com/download>.

1.2.1 Program download

The program is available for download on <http://www.clcbio.com/download>.

Before you download the program you are asked to fill in the **Download** dialog.

In the dialog you must choose:

- Which operating system you use
- Whether you would like to receive information about future releases

Depending on your operating system and your Internet browser, you are taken through some download options.

When the download of the installer (an application which facilitates the installation of the program) is complete, follow the platform specific instructions below to complete the installation procedure.

1.2.2 Installation on Microsoft Windows

Starting the installation process is done in one of the following ways:

When you have downloaded an installer:

Locate the downloaded installer and double-click the icon.

The default location for downloaded files is your desktop.

Installing the program is done in the following steps:

- On the welcome screen, click **Next**.
- Read and accept the License agreement and click **Next**.
- Choose where you would like to install the application and click **Next**.
- Choose a name for the Start Menu folder used to launch *CLC Genomics Workbench* and click **Next**.

- Choose if *CLC Genomics Workbench* should be used to open CLC files and click **Next**.
- Choose where you would like to create shortcuts for launching *CLC Genomics Workbench* and click **Next**.
- Choose if you would like to associate .clc files to *CLC Genomics Workbench*. If you check this option, double-clicking a file with a ".clc" extension will open the *CLC Genomics Workbench*.
- Wait for the installation process to complete, choose whether you would like to launch *CLC Genomics Workbench* right away, and click **Finish**.

When the installation is complete the program can be launched from the Start Menu or from one of the shortcuts you chose to create.

1.2.3 Installation on Mac OS X

Starting the installation process is done in the following way:

When you have downloaded an installer:

Locate the downloaded installer and double-click the icon.

The default location for downloaded files is your desktop.

Launch the installer by double-clicking on the "*CLC Genomics Workbench*" icon.

Installing the program is done in the following steps:

- On the welcome screen, click **Next**.
- Read and accept the License agreement and click **Next**.
- Choose where you would like to install the application and click **Next**.
- Choose if *CLC Genomics Workbench* should be used to open CLC files and click **Next**.
- Choose whether you would like to create desktop icon for launching *CLC Genomics Workbench* and click **Next**.
- Choose if you would like to associate .clc files to *CLC Genomics Workbench*. If you check this option, double-clicking a file with a ".clc" extension will open the *CLC Genomics Workbench*.
- Wait for the installation process to complete, choose whether you would like to launch *CLC Genomics Workbench* right away, and click **Finish**.

When the installation is complete the program can be launched from your Applications folder, or from the desktop shortcut you chose to create. If you like, you can drag the application icon to the dock for easy access.

1.2.4 Installation on Linux with an installer

Navigate to the directory containing the installer and execute it. This can be done by running a command similar to:

```
# sh CLCGenomicsWorkbench_9_5_64.sh.sh
```

Installing the program is done in the following steps:

- On the welcome screen, click **Next**.
- Read and accept the License agreement and click **Next**.
- Choose where you would like to install the application and click **Next**.
For a system-wide installation you can choose for example /opt or /usr/local. If you do not have root privileges you can choose to install in your home directory.
- Choose where you would like to create symbolic links to the program
DO NOT create symbolic links in the same location as the application.
Symbolic links should be installed in a location which is included in your environment PATH. For a system-wide installation you can choose for example /usr/local/bin. If you do not have root privileges you can create a 'bin' directory in your home directory and install symbolic links there. You can also choose not to create symbolic links.
- Wait for the installation process to complete and click **Finish**.

If you choose to create symbolic links in a location which is included in your PATH, the program can be executed by running the command:

```
# clcgenomicswb8
```

Otherwise you start the application by navigating to the location where you choose to install it and running the command:

```
# ./clcgenomicswb8
```

1.3 System requirements

- Windows 7, Windows 8, Windows 10 or Windows Server 2012
- Mac OS X 10.9, 10.10, 10.11 and 10.12
- Linux: RHEL 6.0 and later, SUSE 13.1 and later. Minimum linux versions needed for the SRA download functionality: Red Hat 6, Fedora 12, and SUSE 11.
- 64 bit operating system
- 2 GB RAM required
- 4 GB RAM recommended
- 1024 x 768 display required
- 1600 x 1200 display recommended
- Intel or AMD CPU required

- **Special requirements for the 3D Molecule Viewer**

- **System requirements**

- * A graphics card capable of supporting OpenGL 2.0.
 - * Updated graphics drivers. Please make sure the latest driver for the graphics card is installed .

- **System Recommendations**

- * A discrete graphics card from either Nvidia or AMD/ATI. Modern integrated graphics cards (such as the Intel HD Graphics series) may also be used, but these are usually slower than the discrete cards.

Indirect rendering (such as x11 forwarding through ssh), remote desktop connection/VNC, and running in virtual machines is not supported.

- **Special requirements for read mapping.** The numbers below give minimum and recommended memory for systems running mapping and analysis tasks. The requirements suggested are based on the genome size.

- **E. coli K12 (4.6 megabases)**

- * Minimum: 2 GB RAM
 - * Recommended: 4 GB RAM

- **C. elegans (100 megabases) and Arabidopsis thaliana (120 megabases)**

- * Minimum: 2 GB RAM
 - * Recommended: 4 GB RAM

- **Zebrafish (1.5 gigabases)**

- * Minimum: 2 GB RAM
 - * Recommended: 4 GB RAM

- **Human (3.2 gigabases) and Mouse (2.7 gigabases)**

- * Minimum: 6 GB RAM
 - * Recommended: 8 GB RAM

- **Special requirements for de novo assembly.** *De novo* assembly may need more memory than stated above - this depends both on the number of reads, error profile and the complexity and size of the genome. See <http://www.clcbio.com/white-paper> for examples of the memory usage of various data sets.

1.3.1 Limitations on maximum number of cores

Most modern CPUs implements hyper threading or a similar technology which makes each physical CPU core appear as two logical cores on a system. In this manual the term "core" always refer to a logical core unless otherwise stated.

For static licenses, there is a limitation on the number of logical cores on the computer. If there are more than 64 logical cores, the *CLC Genomics Workbench* cannot be started. In this case, a network license is needed (read more at <http://www.clcbio.com/desktop-applications/licensing/>).

1.4 Workbench Licenses

When you have installed the *CLC Genomics Workbench*, and start it for the first time or after installing a new major release, you will meet the license assistant, shown in figure 1.1. The **License Manager** can also be accessed from the menu bar in the Workbench:

Help | License Manager

This can be useful if you wish to use a different license or want to view information about the license(s) the Workbench is currently using. The **License Manager** is described in detail in section 1.4.5 and can be seen in figure 1.23.

To install a license, you must be running the program in administrative mode ¹.

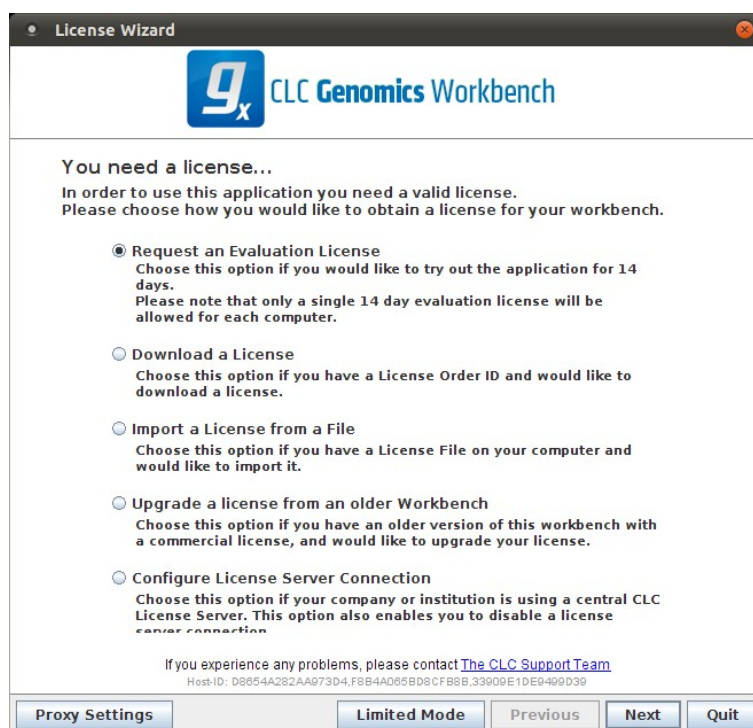

Figure 1.1: The license assistant showing you the options for getting started.

The following options are available. They are described in detail in the sections that follow.

- **Request an evaluation license.** Request a fully functional, time-limited license (see below).
- **Download a license.** Use the license order ID received when you purchase the software to download and install a license file.
- **Import a license from a file.** Import an existing license file, for example a file downloaded from the web-based licensing system.
- **Upgrade license.** If you have used a previous version of the *CLC Genomics Workbench*, and you are entitled to upgrade to a new major version, select this option to upgrade your license file.

¹How to do this differs for different operating systems. To run the program in administrator mode on Windows Vista, or 7, right-click the program shortcut and choose "Run as Administrator.

- **Configure license server connection.** If your organization has a CLC License Server, select this option to configure the connection to it.

Select the appropriate option and click on button labeled **Next**.

To use the Download option in the License Manager, your machine must be able to access the external network. If this is not the case, please see section 1.4.6.

If for some reason you don't have a license order ID or access to a license, you can click the **Limited Mode** button (see section 1.4.7).

1.4.1 Request an evaluation license

We offer a fully functional version of the *CLC Genomics Workbench* for evaluation purposes, free of charge.

Each user is entitled to a 14-day trial of *CLC Genomics Workbench*.

If you are unable to complete your assessment in the available time, please send an email to bioinformaticssales@qiagen.com to request an additional evaluation period.

When you choose the option **Request an evaluation license**, you will see the dialog shown in figure 1.2.

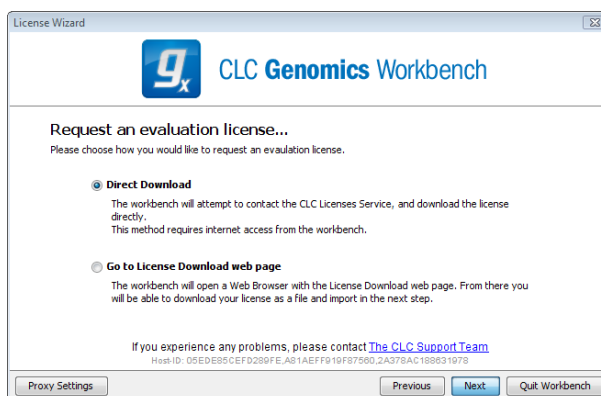

Figure 1.2: Choosing between direct download or going to the license download web page.

In this dialog, there are two options:

- **Direct download.** Download the license directly. This method requires that the Workbench has access to the external network.
- **Go to license download web page.** In a browser window, show the license download web page, which can be used to download a license file. This option is suitable in situations where, for example, you are working behind a proxy, so that the Workbench does not have direct access to the CLC Licenses Service.

If you select the option to download a license directly and it turns out that the Workbench does not have direct access to the external network, (because of a firewall, proxy server etc.), you can click **Previous** button to try the other method.

After selection on your method of choice, click on the button labeled **Next**.

Direct download

After choosing the **Direct Download** option and clicking on the button labeled **Next**, the dialog shown in figure 1.3 appears.

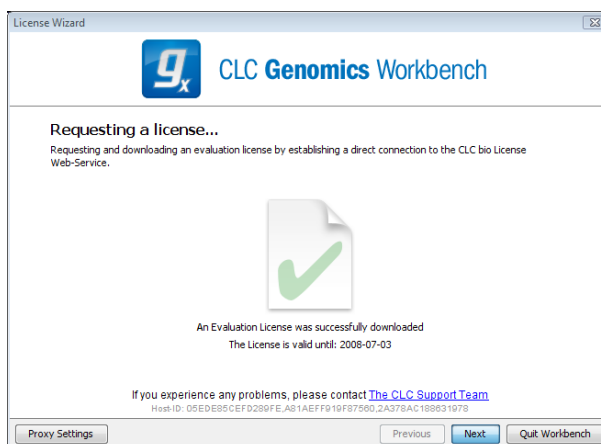

Figure 1.3: A license has been downloaded.

A progress for getting the license is shown, and when the license is downloaded, you will be able to click **Next**.

Go to license download web page

After choosing the *Go to license download web page* option and clicking on the button labeled **Next**, the license download web page appears in a browser window, as shown in 1.4.

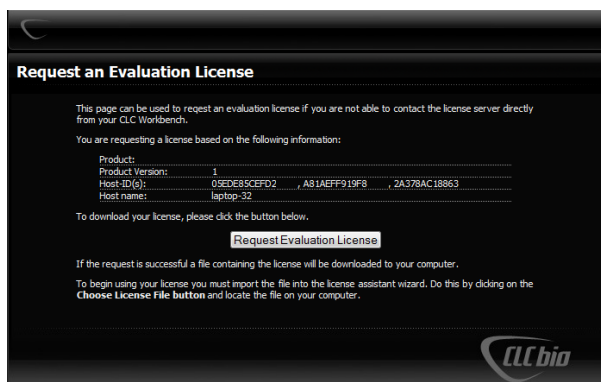

Figure 1.4: The license download web page.

Click the **Request Evaluation License** button. You can then save the license on your system.

Back in the Workbench window, you will now see the dialog shown in 1.5.

Click the **Choose License File** button and browse to find the license file you saved. When you have selected the file, click on the button labeled **Next**.

Accepting the license agreement

Part of the installation of the license involves checking and accepting the end user license agreement (EULA). You should now see the a window like that in figure 1.6.

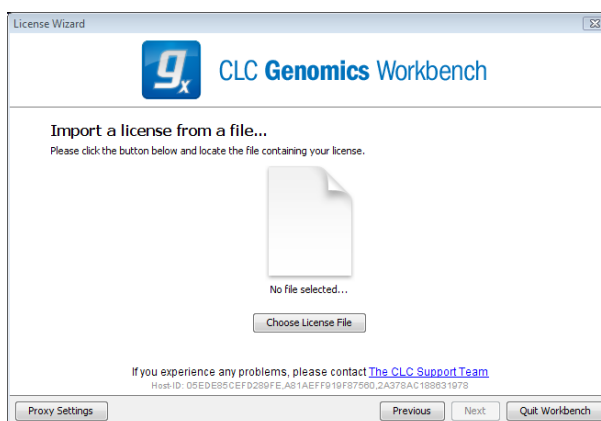

Figure 1.5: Importing the license file downloaded from the web page.

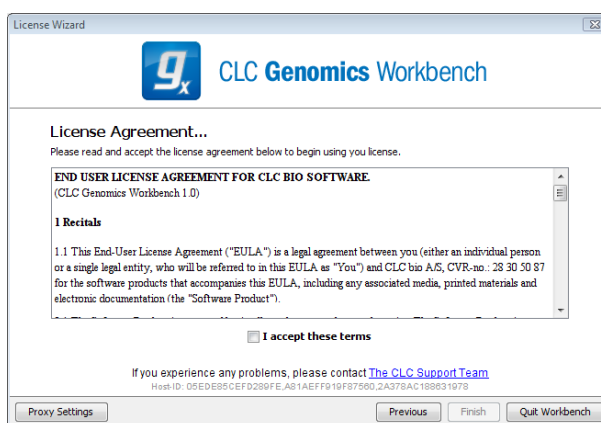

Figure 1.6: Read the license agreement carefully.

Please read the EULA text carefully before clicking in the box next to the text **I accept these terms** to accept, and then clicking on the button labeled **Finish**.

1.4.2 Download a license using a license order ID

Using a license order ID, you can download a license file via the Workbench or using an online form. When you have chosen this option and clicked **Next** button, you will see the dialog shown in 1.7. Enter your license order ID into the text field under the title License Order-ID. (The ID can be pasted into the box after copying it and then using menus or key combinations like Ctrl+V on some system or ⌘ + V on Mac).

In this dialog, there are two options:

- **Direct download.** Download the license directly. This method requires that the Workbench has access to the external network.
- **Go to license download web page.** In a browser window, show the license download web page, which can be used to download a license file. This option is suitable in situations where, for example, you are working behind a proxy, so that the Workbench does not have direct access to the CLC Licenses Service.

If you select the option to download a license directly and it turns out that the Workbench does

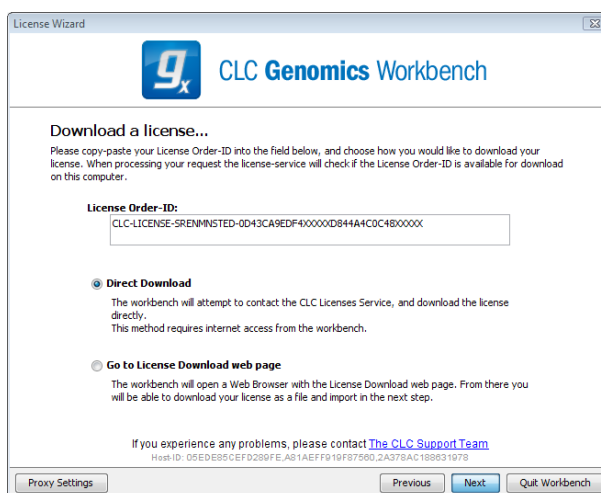

Figure 1.7: Enter a license order ID for the software.

not have direct access to the external network, (because of a firewall, proxy server etc.), you can click **Previous** button to try the other method.

After selection on your method of choice, click on the button labeled **Next**.

Direct download

After choosing the **Direct Download** option and clicking on the button labeled **Next**, the dialog shown in figure 1.8 appears.

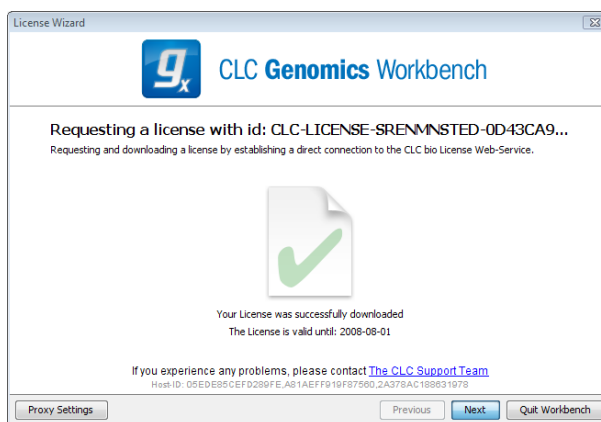

Figure 1.8: A license has been downloaded.

A progress for getting the license is shown, and when the license is downloaded, you will be able to click **Next**.

Go to license download web page

After choosing the *Go to license download web page* option and clicking on the button labeled **Next**, the license download web page appears in a browser window, as shown in 1.9.

Click the **Request Evaluation License** button. You can then save the license on your system.

Back in the Workbench window, you will now see the dialog shown in 1.10.

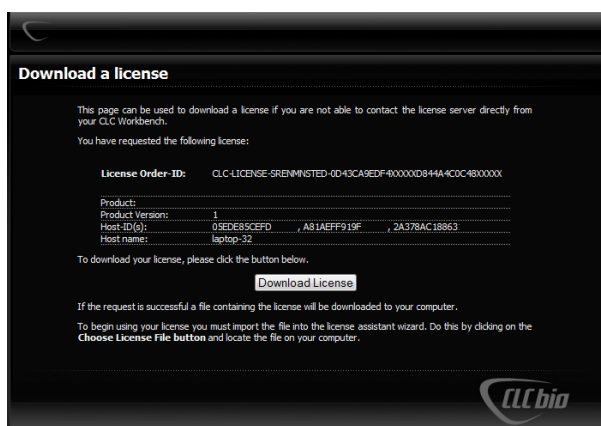

Figure 1.9: The license download web page.

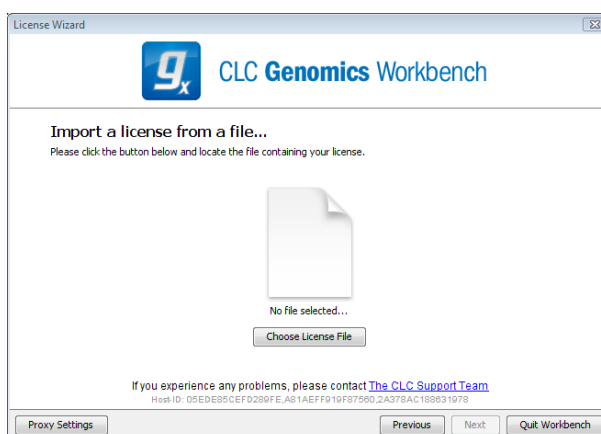

Figure 1.10: Importing the license file downloaded from the web page.

Click the **Choose License File** button and browse to find the license file you saved. When you have selected the file, click on the button labeled **Next**.

Accepting the license agreement

Part of the installation of the license involves checking and accepting the end user license agreement (EULA). You should now see the a window like that in figure 1.11.

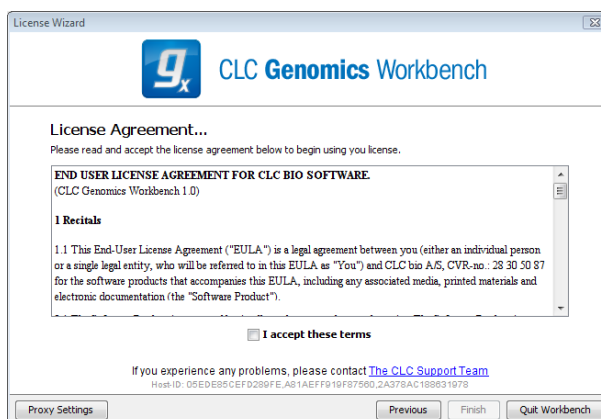

Figure 1.11: Read the license agreement carefully.

Please read the EULA text carefully before clicking in the box next to the text **I accept these**

terms to accept, and then clicking on the button labeled **Finish**.

1.4.3 Import a license from a file

If you already have a license file associated with the host ID of your machine, it can be imported using this option.

When you have clicked on the **Next** button, you will see the dialog shown in 1.12.

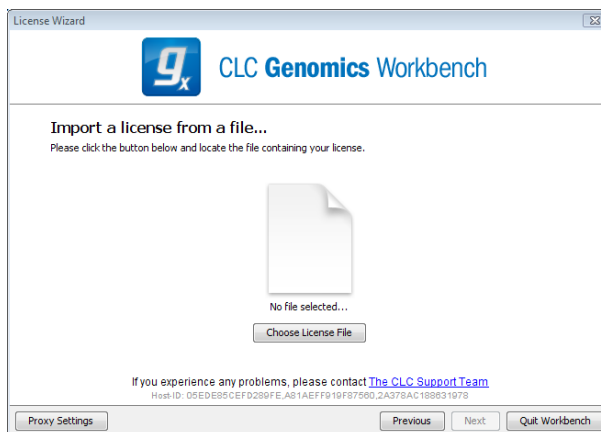

Figure 1.12: Selecting a license file .

Click the **Choose License File** button and browse to find the license file. When you have selected the file, click on the **Next** button.

Accepting the license agreement

Part of the installation of the license involves checking and accepting the end user license agreement (EULA). You should now see the a window like that in figure 1.13.

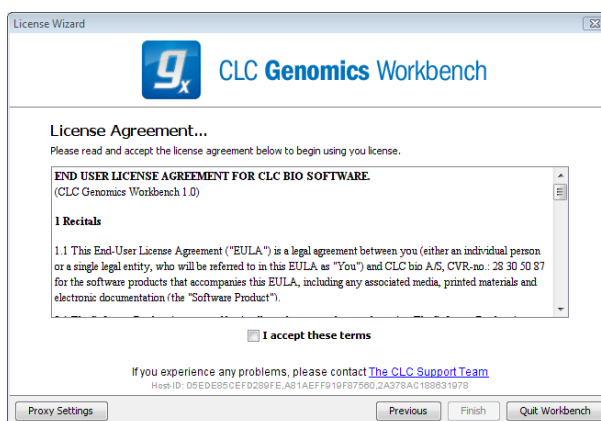

Figure 1.13: Read the license agreement carefully.

Please read the EULA text carefully before clicking in the box next to the text **I accept these terms** to accept, and then clicking on the button labeled **Finish**.

1.4.4 Upgrade license

This option is used when you already have used a previous version of *CLC Genomics Workbench*, and you are entitled to upgrade to a new major version. The Workbench will need direct access to the external network to use this option.

When you click on the **Next** button, the Workbench will search for a previous installation of *CLC Genomics Workbench*. It will then locate the old license.

If the Workbench finds an existing license file, the next dialog will look like figure 1.14.

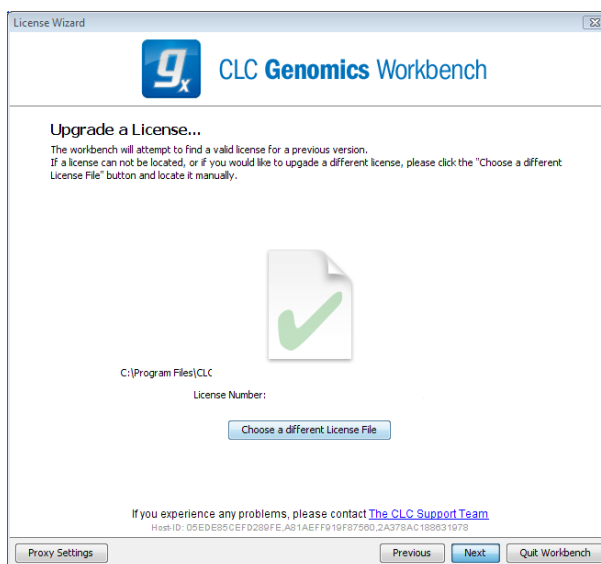

Figure 1.14: An license from an older installation is found.

When you click on the **Next** button, the Workbench checks if you are entitled to upgrade your license. This is done by contacting QIAGEN Aarhus servers.

If the Workbench cannot connect to the external network directly, please see the section on downloading a license for non-networked machines. You will need your license order ID for this.

Your license must be covered by our Maintenance, Upgrades and Support (MUS) program to be eligible to upgrade your license. If the license is covered for upgrades and there are any problems with this, please contact licenses@clcbio.com.

In this dialog, there are two options:

- **Direct download.** Download the license directly. This method requires that the Workbench has access to the external network.
- **Go to license download web page.** In a browser window, show the license download web page, which can be used to download a license file. This option is suitable in situations where, for example, you are working behind a proxy, so that the Workbench does not have direct access to the CLC Licenses Service.

If you select the option to download a license directly and it turns out that the Workbench does not have direct access to the external network, (because of a firewall, proxy server etc.), you can click **Previous** button to try the other method.

After selection on your method of choice, click on the button labeled **Next**.

Direct download

After choosing the **Direct Download** option and clicking on the button labeled **Next**, the dialog shown in figure 1.15 appears.

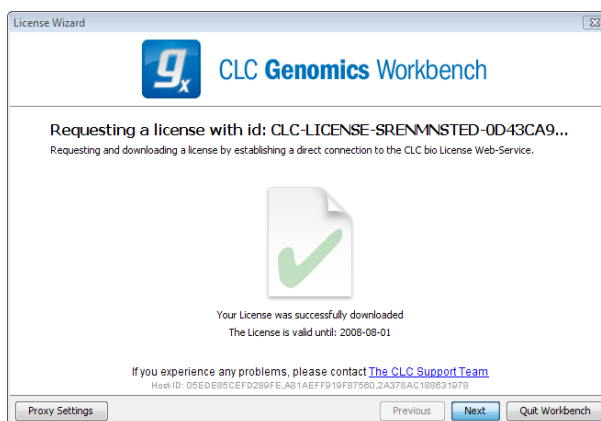

Figure 1.15: A license has been downloaded.

A progress for getting the license is shown, and when the license is downloaded, you will be able to click **Next**.

Go to license download web page

After choosing the *Go to license download web page* option and clicking on the button labeled **Next**, the license download web page appears in a browser window, as shown in 1.16.

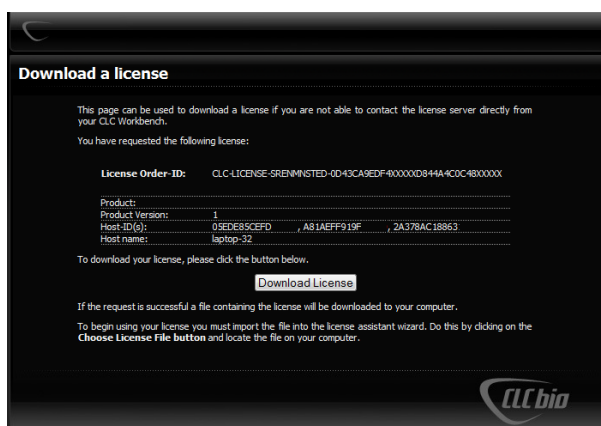

Figure 1.16: The license download web page.

Click the **Request Evaluation License** button. You can then save the license on your system.

Back in the Workbench window, you will now see the dialog shown in 1.17.

Click the **Choose License File** button and browse to find the license file you saved. When you have selected the file, click on the button labeled **Next**.

Accepting the license agreement

Part of the installation of the license involves checking and accepting the end user license agreement (EULA). You should now see the a window like that in figure 1.18.

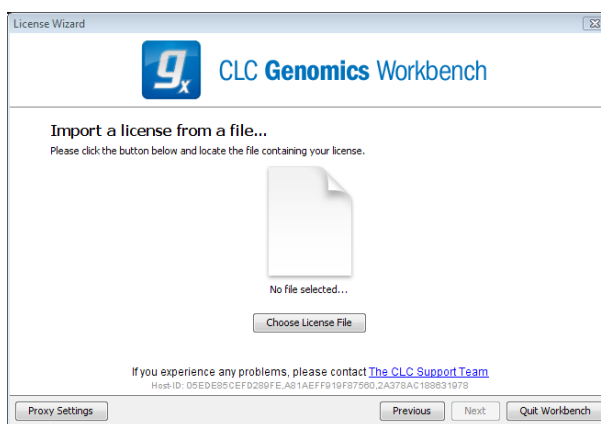

Figure 1.17: Importing the license file downloaded from the web page.

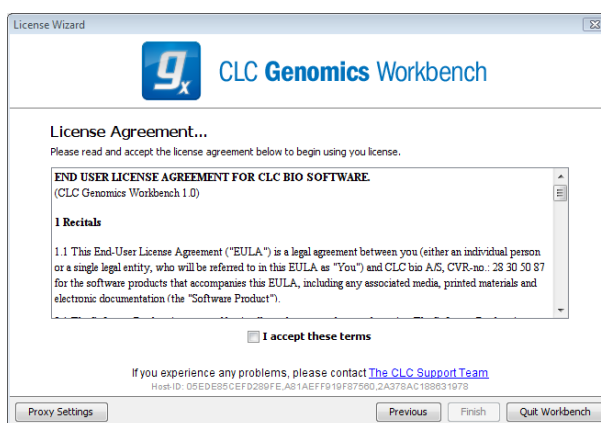

Figure 1.18: Read the license agreement carefully.

Please read the EULA text carefully before clicking in the box next to the text **I accept these terms** to accept, and then clicking on the button labeled **Finish**.

1.4.5 Configure license server connection

If your organization is running a CLC License Server, you can configure your Workbench to connect to it to get a license.

To do this, select this option and click on the **Next** button. A dialog like that shown in figure 1.19 then appears. Here, you configure how to connect to the CLC License Server.

- **Enable license server connection.** This box must be checked for the Workbench is to contact the CLC License Server to get a license for *CLC Genomics Workbench*.
- **Automatically detect license server.** By checking this option the Workbench will look for a CLC License Server accessible from the Workbench².

²Automatic server discovery sends UDP broadcasts from the Workbench on a fixed port, 6200. Available license servers respond to the broadcast. The Workbench then uses TCP communication for to get a license, assuming one is available. Automatic server discovery works only on local networks and will not work on WAN or VPN connections. Automatic server discovery is not guaranteed to work on all networks. If you are working on an enterprise network on where local firewalls or routers cut off UDP broadcast traffic, then you may need to configure the details of the CLC License server manually instead.

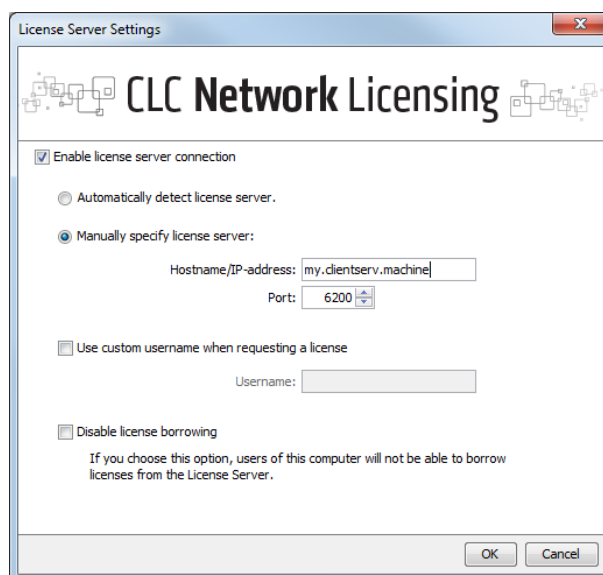

Figure 1.19: Connecting to a CLC License Server.

- **Manually specify license server.** If there are technical limitations such that the CLC License Server cannot be detected automatically, use this option to provides details of machine the CLC License Server software is on, and the port used by the software to receive requests. After selecting this option, please enter:
 - **Host name.** The address for the machine the CLC Licenser Server software is running on.
 - **Port.** The port used by the CLC License Server to receive requests.
- **Use custom username when requesting a license.** A username entered here will be passed to the CLC License Server instead of the username of your account this machine.
- **Disable license borrowing on this computer.** If you do not want users of the computer to borrow a license from the set of licenses available, then (see section 1.4.5), select this option.

Borrowing a license

A network license can only be used when you are connected to the a license server. If you wish to use the *CLC Genomics Workbench* when you are not connected to the CLC License Server, you can *borrow* an available license for a period of time. During this time, there will be one less network license available on the for other users. The Workbench must have a connection to the CLC License Server at the point in time when you wish to borrow a license.

The procedure for borrowing a license is:

1. Go to the Workbench menu option:
Help | License Manager
2. Click on the "Borrow License" tab to display the dialog shown in figure 1.20.
3. Use the checkboxes at the right hand side of the table in the License overview section of the window to select the license(s) that you wish to borrow.

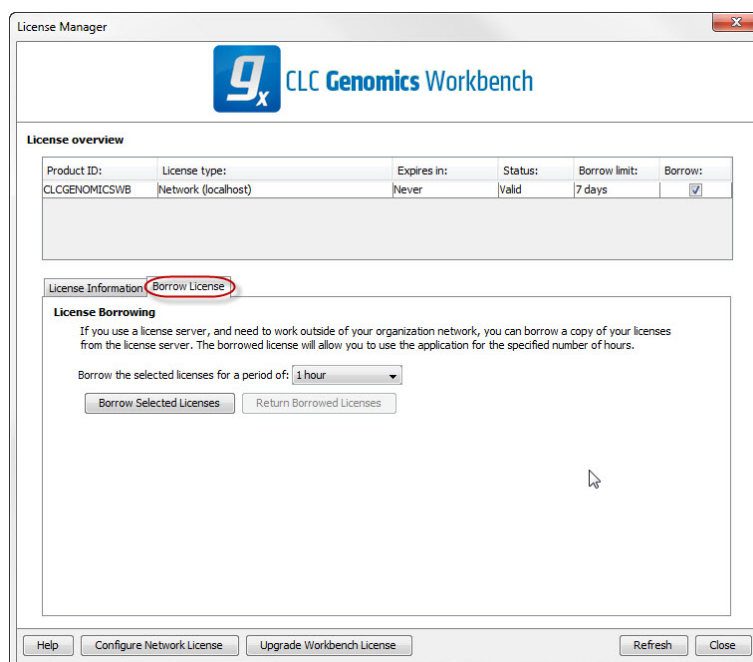

Figure 1.20: Borrow a license.

4. Select the length of time you wish to borrow the license(s).
5. Click on the button labeled **Borrow Licenses**.
6. Close the License Manager when you are done.

You can now go offline and work with the *CLC Genomics Workbench*. When the time period you borrowed the license for has elapsed, the network license you borrowed is made available again for other users to access. To continue using the *CLC Genomics Workbench* with a license, you will need to connect the Workbench to the network again so it can contact the CLC License Server to obtain one.

Note! Your CLC License Server administrator can choose to disable the option allowing the borrowing of licenses. If this has been done, you will not be able to borrow a network license using your Workbench.

Common issues when using a network license

No license available at the moment If all the network licenses or *CLC Genomics Workbench* are in use, you will see a dialog like that shown in figure 1.21 when you start up the Workbench.

This means others are using the network licenses. You will need to wait for them to return their licenses before you can continue to work with a fully functional copy of software. If this is a frequent issue, you may wish to discuss this with your CLC License Server administrator.

Clicking on the **Limited Mode** button in the dialog allows you to start the Workbench with functionality equivalent to the CLC Sequence Viewer. This includes the ability to access your CLC data.

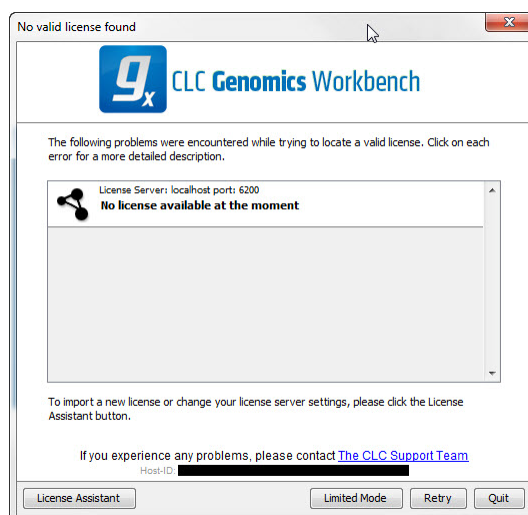

Figure 1.21: This window appears when there are no available network licenses for the software you are running.

Lost connection to the CLC License Server If the Workbench connection to the CLC License Server is lost, you will see a dialog as shown in figure 1.22.

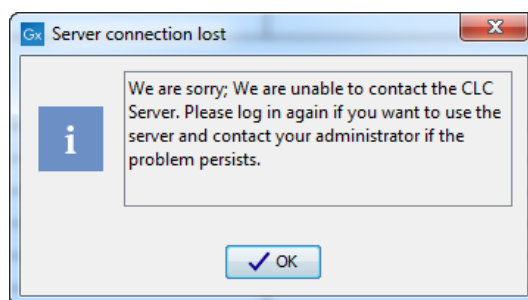

Figure 1.22: This message appears if the Workbench is unable to establish a connection to a CLC License server.

If you have chosen the option to **Automatically detect license server** and you have not succeeded in connecting to the License Server before, please check with your local IT support that automatic detection will be possible to do at your site. If it is not possible at your site, you will need to manually configure the CLC License Server settings using the License Manager, as described earlier in this section.

If you have successfully contacted the CLC License Server from your Workbench previously, please consider discussing this issue with your CLC License Server administrator or your local IT support, to make sure that the CLC License Server is running and that your Workbench can connect to it. There may be situations where you wish to use a different license or view information about the license(s) the Workbench is currently using. To do this, open the License Manager using the menu option:

Help | License Manager (📄)

The license manager is shown in figure 1.23.

This dialog can be used to:

- See information about the license (e.g. what kind of license, when it expires)

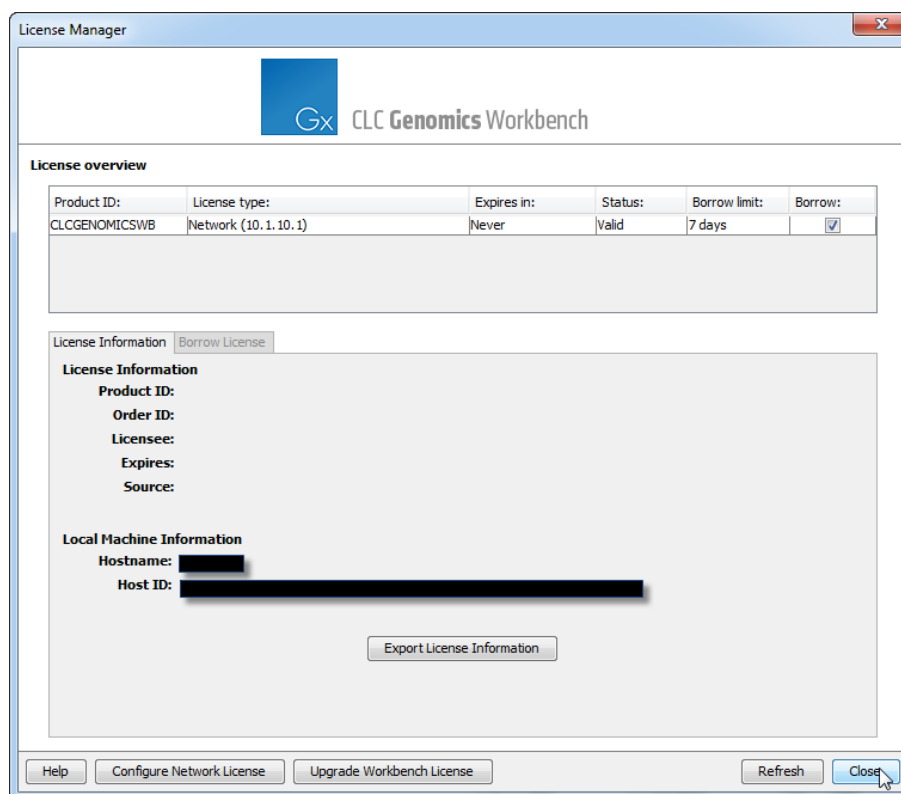

Figure 1.23: The license manager.

- Configure how to connect to a license server (**Configure License Server** the button at the lower left corner). Clicking this button will display a dialog similar to figure 1.19.
- Upgrade from an evaluation license by clicking the **Upgrade license** button. This will display the dialog shown in figure 1.1.
- Export license information to a text file.
- Borrow a license

If you wish to switch away from using a network license, click on the button to **Configure License Server** and uncheck the box beside the text **Enable license server connection** in the dialog. When you restart the Workbench, you can set up the new license as described in section 1.4.

1.4.6 Download a static license on a non-networked machine

To download a static license for a machine that does not have direct access to the external network, you can follow the steps below:

- Install the *CLC Genomics Workbench* on the machine you wish to run the software on.
- Start up the software as an administrative user and find the host ID of the machine that you will run the CLC Workbench on. You can see the host ID the machine reported at the bottom of the License Manager window in grey text.
- Make a copy of this host ID such that you can use it on a machine that has internet access.

- Go to a computer with internet access, open a browser window and go to the relevant network license download web page:
- For Workbenches released from January 2013 and later, (e.g. the Genomics Workbench version 6.0 or higher, and the Main Workbench, version 6.8 or higher), please go to:
<https://secure.clcbio.com/LmxWSv3/GetLicenseFile>
For earlier Workbenches, including any DNA, Protein or RNA Workbench, please go to:
<http://licensing.clcbio.com/LmxWSv1/GetLicenseFile>
It is vital that you choose the license download page appropriate to the version of the software you plan to run.
- Paste in your license order ID and the host ID that you noted down in the relevant boxes on the webpage.
- Click 'download license' and save the resulting .lic file.
- Open the Workbench on your non-networked machine. In the Workbench license manager choose 'Import a license from a file'. In the resulting dialog click 'choose license file' to browse the location of the .lic file you have just downloaded.
If the License Manager does not start up by default, you can start it up by going to the Help menu and choosing License Manager.
- Click on the **Next** button and go through the remaining steps of the license manager wizard.

1.4.7 Limited mode

We have created the limited mode to prevent a situation where you are unable to access your data because you do not have a license. When you run in limited mode, a lot of the tools in the Workbench are not available, but you still have access to your data (also when stored in a *CLC Bioinformatics Database*). When running in limited mode, the functionality is equivalent to the *CLC Sequence Viewer*. To get out of the limited mode and run the Workbench normally, restart the Workbench. When you restart the Workbench will try to find a proper license and if it does, it will start up normally. If it can't find a license, you will again have the option of running in limited mode.

1.4.8 Start in safe mode

If the program becomes unstable on start-up, you can start it in **Safe mode**. This is done by pressing and holding down the Shift button while the program starts.

When starting in safe mode, the user settings (e.g. the settings in the **Side Panel**) are deleted and cannot be restored. Your data stored in the **Navigation Area** is not deleted. When started in safe mode, some of the functionalities are missing, and you will have to restart the *CLC Genomics Workbench* again (without pressing Shift).

1.4.9 CLC Sequence Viewer vs. Workbenches

The *CLC Sequence Viewer* is a user friendly application offering basic bioinformatics analyses. The *CLC Sequence Viewer* is a free product that does not require access to a license before use.

It can be used to view outputs from many analyses of the CLC commercial workbenches, with notable exceptions being workflows and track-based data, which can only be viewed using our commercial Workbench offerings: track-based outputs can be viewed using the *CLC Genomics Workbench* and *CLC Main Workbench*, while workflows can be viewed in all commercial CLC workbenches, including the *CLC Main Workbench*, *CLC Genomics Workbench* and the *CLC Drug Discovery Workbench*.

The CLC Workbenches and the *CLC Sequence Viewer* are developed for Windows, Mac and Linux platforms. Data can be exported/imported between the different platforms in the same easy way as when exporting/importing between two computers.

1.5 When the program is installed: Getting started

CLC Genomics Workbench includes an extensive **Help** function, which can be found in the **Help** menu of the program's **Menu bar**. The **Help** can also be shown by pressing F1. The help topics are sorted in a table of contents and the topics can be searched.

Tutorials describing hands-on examples of how to use the individual tools and features of the *CLC Genomics Workbench* can be found at <http://www.qiagenbioinformatics.com/support/tutorials/>. We also recommend our **Online presentations** where a product specialist demonstrates our software. This is a very easy way to get started using the program. Read more about video tutorials and other online presentations here: <http://tv.qiagenbioinformatics.com/>.

1.5.1 Quick start

When the program opens for the first time, the background of the workspace is visible. In the background are three quick start shortcuts, which will help you getting started. These can be seen in figure 1.24.



Figure 1.24: Quick start shortcuts, available in the background of the workspace.

The function of the quick start shortcuts is explained here:

- **Import data.** Opens the **Import** dialog, which you let you browse for, and import data from your file system.
- **New sequence.** Opens a dialog which allows you to enter your own sequence.
- **Read tutorials.** Opens the tutorials menu with a number of tutorials. These are also available from the **Help** menu in the **Menu bar**.

1.5.2 Import of example data

It might be easier to understand the logic of the program by trying to do simple operations on existing data. Therefore *CLC Genomics Workbench* includes an example data set.

When downloading *CLC Genomics Workbench* you are asked if you would like to import the example data set. If you accept, the data is downloaded automatically and saved in the program. If you didn't download the data, or for some other reason need to download the data again, you have two options:

You can click **Import Example Data**  in the **Help** menu of the program. This imports the data automatically. You can also go to <http://www.clcbio.com/download> and download the example data from there.

If you download the file from the website, you need to import it into the program. See chapter 6 for more about importing data.

1.6 Plugins



When you install *CLC Genomics Workbench*, it has a standard set of features. However, you can upgrade and customize the program using a variety of plugins.

As the range of plugins is continuously updated and expanded, they will not be listed here. Instead we refer to <http://www.qiagenbioinformatics.com/plugins/> for a full list of plugins with descriptions of their functionalities.

1.6.1 Installing plugins

Note: In order to install plugins and modules, the Workbench must be run in administrator mode. On Linux and Mac, it means you must be logged in as an administrator. On Windows, you can do this by right-clicking the program shortcut and choosing "Run as Administrator".

Plugins are installed and uninstalled using the plugin manager.

Help in the Menu Bar | Plugins... () or Plugins () in the Toolbar

The plugin manager has two tabs at the top:

- **Manage Plugins.** This is an overview of plugins that are installed.
- **Download Plugins.** This is an overview of available plugins on QIAGEN Aarhus server.

1.7 Install

To install a plugin, click the **Download Plugins** tab. This will display an overview of the plugins that are available for download and installation (see figure 1.25).

Select plugin to display additional information about the plugin on the right side of the dialog. Click **Download and Install** to add the plugin functionalities to your workbench.

If plugin is not shown on the server but you have the installer file on your computer (for example if you have downloaded it from our website), you can install the plugin by clicking the **Install**

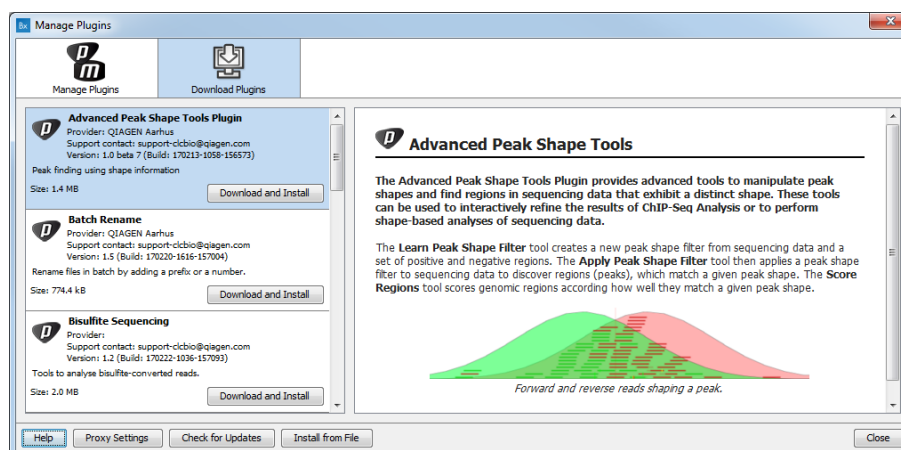



Figure 1.25: The plugins that are available for download.

from **File** button at the bottom of the dialog and specifying the plugin *.cpa file saved on your computer.

When you close the dialog, you will be asked whether you wish to restart the workbench. The plugin will not be ready for use until you have restarted.

1.8 Uninstall

Plugins are uninstalled using the plugin manager:

Help in the Menu Bar | **Plugins...** () or **Plugins** () in the **Toolbar**

This will open the dialog shown in figure 1.27.

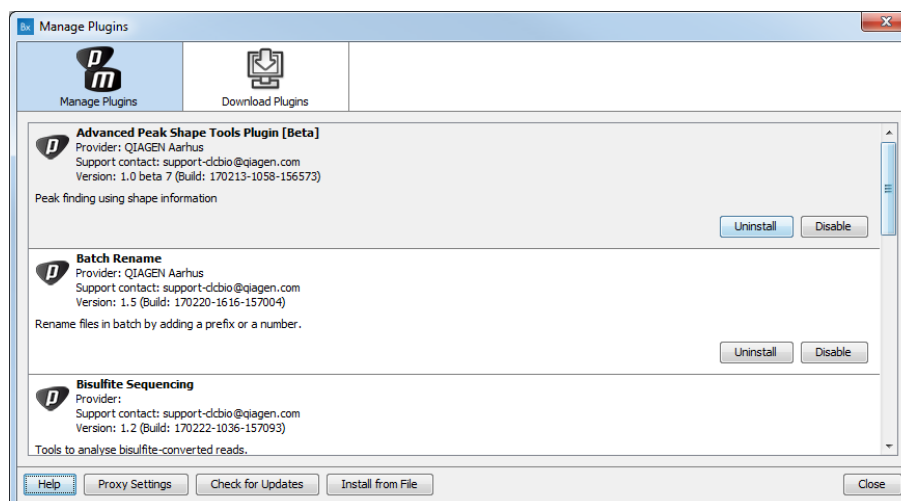

Figure 1.26: The plugin manager with plugins installed.



The installed plugins are shown in the **Manage plugins** tab of the plugin manager. To uninstall, select plugin and click **Uninstall**.

If you do not wish to completely uninstall the plugin, but you do not want it to be used next time you start the Workbench, click the **Disable** button.

When you close the dialog, you will be asked whether you wish to restart the workbench. The plugin will not be uninstalled until the workbench is restarted.

1.8.1 Uninstalling plugins

Plugins are uninstalled using the plugin manager:

Help in the Menu Bar | Plugins... () or Plugins () in the Toolbar

This will open the dialog shown in figure 1.27.

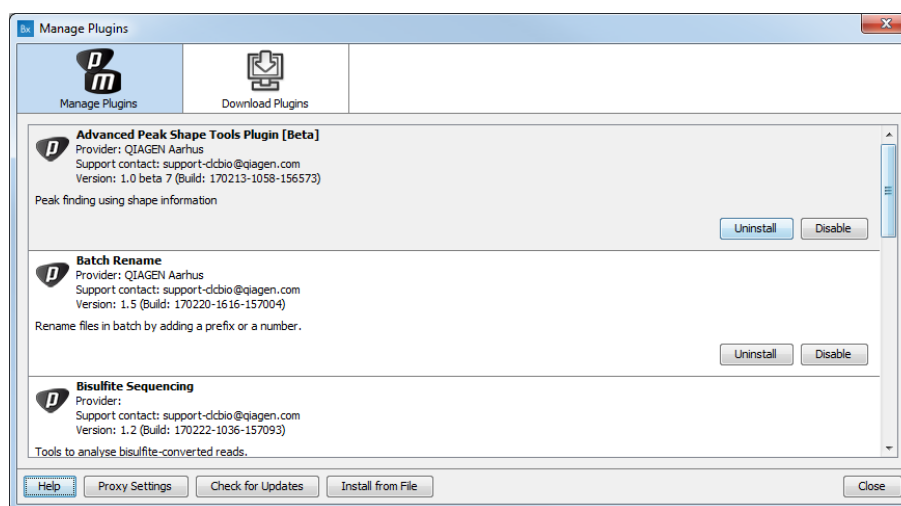

Figure 1.27: The plugin manager with plugins installed.

The installed plugins are shown in this dialog. To uninstall, select plugin and click **Uninstall**.

If you do not wish to completely uninstall the plugin but you don't want it to be used next time you start the Workbench, click the **Disable** button.

When you close the dialog, you will be asked whether you wish to restart the workbench. The plugin will not be uninstalled until the workbench is restarted.

1.8.2 Updating plugins

If a new version of a plugin is available, you will get a notification during start-up as shown in figure 1.28.

In this list, select which plugins you wish to update, and click **Install Updates**. If you press **Cancel** you will be able to install the plugins later by clicking **Check for Updates** in the Plugin manager (see figure 1.27).

1.9 Network configuration

If you use a proxy server to access the Internet you must configure *CLC Genomics Workbench* to use this. Otherwise you will not be able to perform any online activities (e.g. searching GenBank).

CLC Genomics Workbench supports the use of an HTTP-proxy and an anonymous SOCKS-proxy.

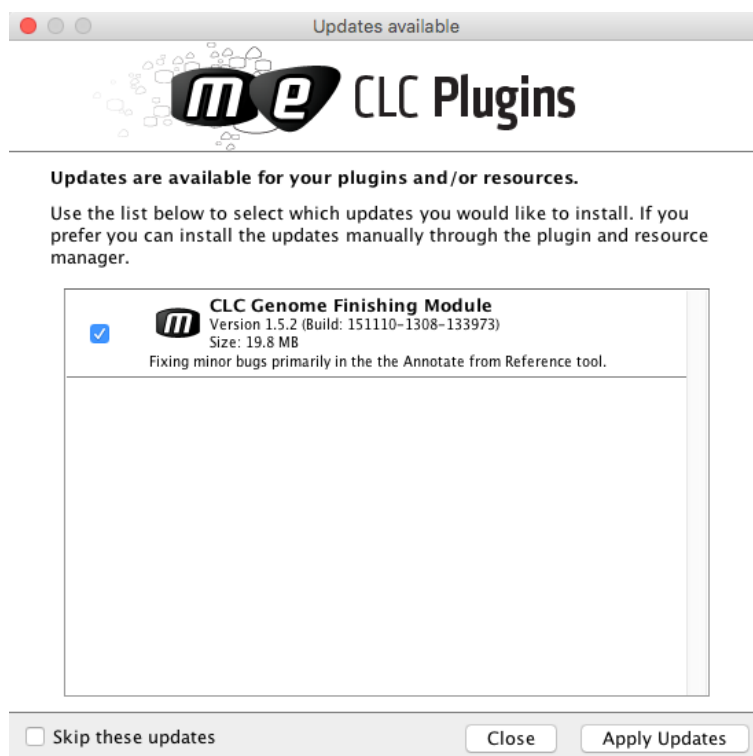

Figure 1.28: Plugin updates.

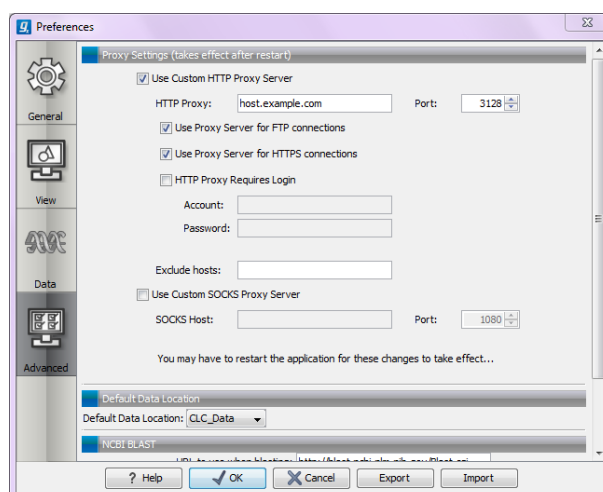

Figure 1.29: Adjusting proxy preferences.

To configure your proxy settings, open *CLC Genomics Workbench*, and go to the **Advanced**-tab of the **Preferences** dialog (figure 1.29) and enter the appropriate information. The **Preferences** dialog is opened from the **Edit** menu.

You have the choice between an HTTP-proxy and a SOCKS-proxy. *CLC Genomics Workbench* only supports the use of a SOCKS-proxy that does not require authorization.

You can select whether the proxy should be used also for FTP and HTTPS connections.

Exclude hosts can be used if there are some hosts that should be contacted directly and not through the proxy server. The value can be a list of hosts, each separated by a |, and in addition a wildcard character * can be used for matching. For example: *.foo.com|localhost.

If you have any problems with these settings you should contact your systems administrator.

1.10 The format of the user manual

This user manual offers support to Windows, Mac OS X and Linux users. The software is very similar on these operating systems. In areas where differences exist, these will be described separately. However, the term "right-click" is used throughout the manual, but some Mac users may have to use Ctrl+click in order to perform a "right-click" (if they have a single-button mouse).

The most recent version of the user manuals can be downloaded from <http://www.qiagenbioinformatics.com/support/manuals/>.

The user manual consists of four parts.

- The **first part** includes the introduction to *CLC Genomics Workbench*.
- The **second part** describes in detail how to operate all the program's basic functionalities.
- The **third part** digs deeper into some of the molecular modeling and bioinformatic features of the program. In this part, you will also find our "Bioinformatics explained" sections. These sections elaborate on the algorithms and analyses of *CLC Genomics Workbench* and provide more general knowledge of molecular modeling and bioinformatic concepts.
- The **fourth part** is the Appendix and Index.

Each chapter includes a short table of contents.

1.11 Latest improvements

CLC Genomics Workbench is being constantly developed and improved. A detailed list of new features, improvements, bug fixes, and changes for the current version of *CLC Genomics Workbench* can be found at:

<https://www.qiagenbioinformatics.com/products/clc-genomics-workbench-latest-improvements>

About the workbenches

In November 2005 CLC bio released two Workbenches: *CLC Free Workbench* and *CLC Protein Workbench*. *CLC Protein Workbench* is developed from the free version, giving it the well-tested user friendliness and look & feel. However, the *CLC Protein Workbench* includes a range of more advanced analyses.

In March 2006, *CLC DNA Workbench* (formerly *CLC Gene Workbench*) and *CLC Main Workbench* were added to the product portfolio of CLC bio. Like *CLC Protein Workbench*, *CLC DNA Workbench* builds on *CLC Free Workbench*. It shares some of the advanced product features of *CLC Protein Workbench*, and it has additional advanced features. *CLC Main Workbench* holds all basic and advanced features of the *CLC Workbenches*.

In June 2007, *CLC RNA Workbench* was released as a sister product of *CLC Protein Workbench* and *CLC DNA Workbench*. *CLC Main Workbench* now also includes all the features of *CLC RNA Workbench*.

In March 2008, the *CLC Free Workbench* changed name to *CLC Sequence Viewer*.

In June 2008, the first version of the *CLC Genomics Workbench* was released due to an extraordinary demand for software capable of handling sequencing data from all new high-throughput sequencing platforms such as Roche-454, Illumina and SOLiD in addition to Sanger reads and hybrid data.

In December 2006, CLC bio released a *Software Developer Kit* which makes it possible for anybody with a knowledge of programming in Java to develop plugins. The plugins are fully integrated with the CLC Workbenches and the Viewer and provide an easy way to customize and extend their functionalities.

In April 2012, *CLC Protein Workbench*, *CLC DNA Workbench* and *CLC RNA Workbench* were discontinued. All customers with a valid license for any of these products were offered an upgrade to the *CLC Main Workbench*.

In February 2014, CLC bio expanded the product repertoire with the release of *CLC Drug Discovery Workbench*, a product that enables studies of protein-ligand interactions for drug discovery.

In April 2014, CLC bio released the *CLC Cancer Research Workbench*, a product that containing streamlined data analysis workflows with integrated trimming and quality control tailored to meet the requirements of clinicians and researchers working within the cancer field.

In April 2015, the *CLC Cancer Research Workbench* was renamed to *Biomedical Genomics Workbench* to reflect the inclusion of tools addressing the requirements of clinicians and researchers working within the hereditary disease field in addition to the tools designed for those working within the cancer field.

Part II

Core Functionalities

Chapter 2

User interface

Contents

2.1 View Area	45
2.1.1 Open view	46
2.1.2 Open additional views with the toolbar	46
2.1.3 History and Info views	47
2.1.4 Close views	48
2.1.5 Save changes in a view	49
2.1.6 Undo/Redo	49
2.1.7 Arrange views in View Area	50
2.1.8 Moving a view to a different screen	52
2.1.9 Side Panel	53
2.2 Zoom and selection in View Area	54
2.2.1 Zoom in	55
2.2.2 Zoom out	55
2.2.3 Selecting, panning and zooming	56
2.3 Toolbox and Status Bar	57
2.3.1 Processes	57
2.3.2 Toolbox	58
2.3.3 Status Bar	60
2.4 Workspace	60
2.4.1 Create Workspace	61
2.4.2 Select Workspace	61
2.4.3 Delete Workspace	61
2.5 List of shortcuts	62

This chapter provides an overview of the different areas in the user interface of *CLC Genomics Workbench*. As can be seen from figure 2.1 this includes a **Navigation Area**, **View Area**, **Menu Bar**, **Toolbar**, **Status Bar** and **Toolbox**.

A description of the **Navigation Area** is tightly connected to the data organization features of *CLC Genomics Workbench* and can be found in section 3.1.

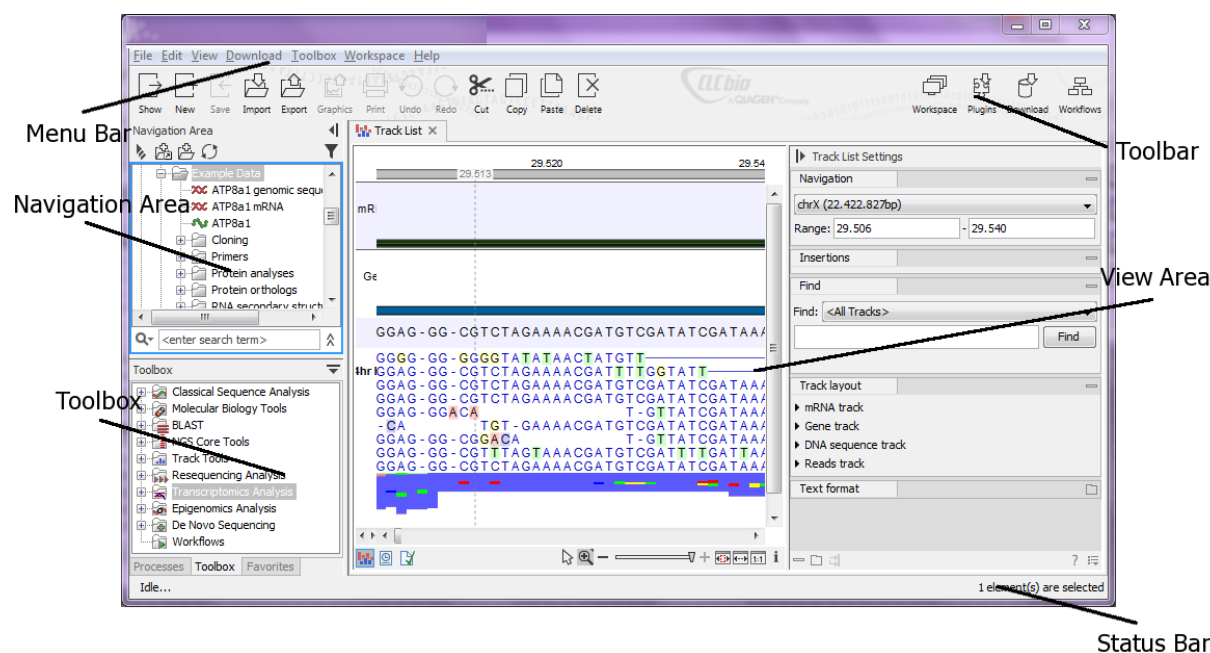

Figure 2.1: The user interface consists of the Menu Bar, Toolbar, Status Bar, Navigation Area, Toolbox, and View Area.

2.1 View Area

The **View Area** is the right-hand part of the screen, displaying your current work. The **View Area** may consist of one or more **Views**, represented by tabs at the top of the **View Area**.

This is illustrated in figure 2.2.

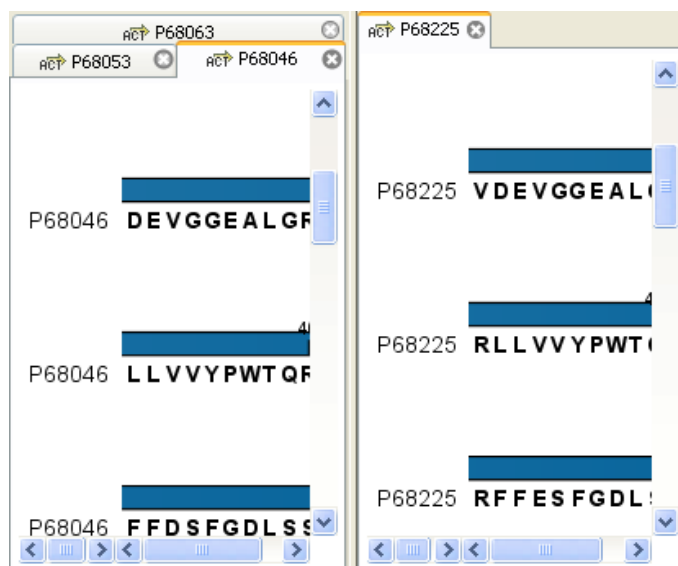

Figure 2.2: A View Area can enclose several views, each view is indicated with a tab (see right view, which shows protein P68225). Furthermore, several views can be shown at the same time (in this example, four views are displayed).

The tab concept is central to working with *CLC Genomics Workbench*, because several operations can be performed by dragging the tab of a view, and extended right-click menus can be activated

from the tabs.

This chapter deals with the handling of views inside a **View Area**. Furthermore, it deals with rearranging the views.

Section 2.2 deals with the zooming and selecting functions.

2.1.1 Open view

Opening a view can be done in a number of ways:

double-click an element in the Navigation Area

or **select an element in the Navigation Area | File | Show | Select the desired way to view the element**

or **select an element in the Navigation Area | Ctrl + O (⌘ + B on Mac)**

Opening a view while another view is already open, will show the new view in front of the other view. The view that was already open can be brought to front by clicking its tab.

Note! If you right-click an open tab of any element, click **Show**, and then choose a different view of the same element, this new view is automatically opened in a split-view, allowing you to see both views.

See section 3.1.5 for instructions on how to open a view using drag and drop.

2.1.2 Open additional views with the toolbar

Each element can be shown in different ways. A sequence, for example, can be shown as linear, circular, text etc.

In the following example, you want to see a sequence in a circular view. If the sequence is already open in a view, you can change the view to a circular view:

Click Show As Circular (○) at the lower left part of the view

The buttons used for switching views are shown in figure 2.3).



Figure 2.3: The buttons shown at the bottom of a view of a nucleotide sequence. You can click the buttons to change the view to e.g. a circular view or a history view.

If the sequence is already open in a linear view (ACT), and you wish to see both a circular and a linear view, you can split the views very easily:

Press Ctrl (⌘ on Mac) while you | Click Show As Circular (○) at the lower left part of the view

This will open a split view with a linear view at the bottom and a circular view at the top (see 10.5).

You can also show a circular view of a sequence without opening the sequence first:

Select the sequence in the Navigation Area | Show (⇨) | As Circular (○)

2.1.3 History and Info views

The two buttons to the right hand side of the toolbar are **Show History** (🕒) and **Show Element Info** (📄).

The History view is a textual log of all operations you make in the program. If for example you rename a sequence, align sequences, create a phylogenetic tree or translate a sequence, you can always go back and check what you have done. In this way, you are able to document and reproduce previous operations.

When an element's history is opened, the newest change is submitted in the top of the view (figure 2.4).

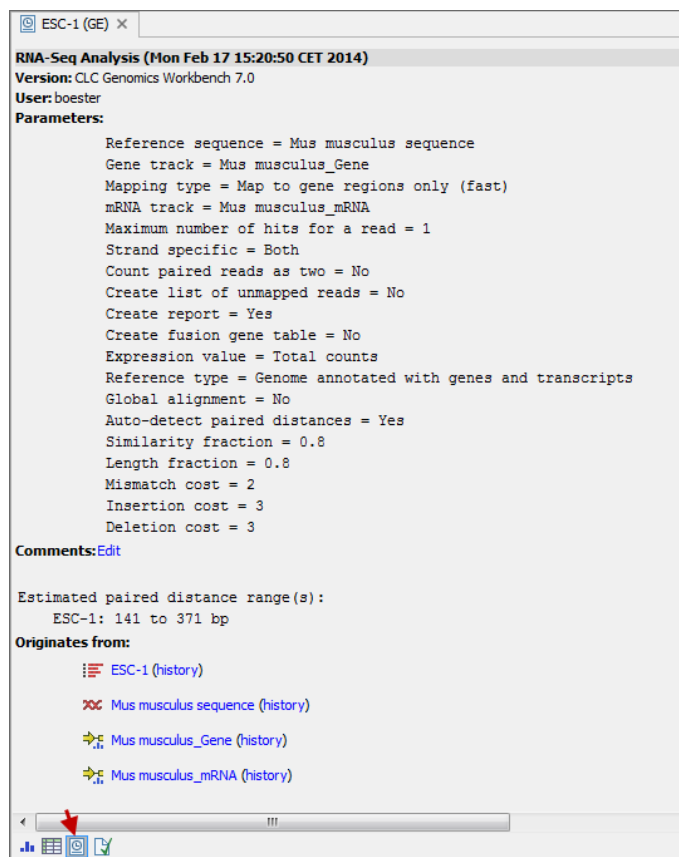

Figure 2.4: An element's history.

The following information is available:

- **Originates from workflow** (optional). In cases where the file was generated by a workflow, the first line will state the Name and Version number of that workflow.
- **Title**. The action that the user performed.
- **Date and time**. Date and time for the operation. The date and time are displayed according to your locale settings (see section 4.1).
- **Version**. The Workbench type and version that has been used.
- **User**. The user who performed the operation. If you import some data created by another person in a CLC Workbench, that person's name will be shown.

- **Parameters.** Details about the action performed. This could be the parameters that were chosen for an analysis.
- **Comments.** By clicking **Edit** you can enter your own comments regarding this entry in the history. These comments are saved.
- **Originates from.** This information is usually shown at the bottom of an element's history. Here, you can see which elements the current element originates from. For example, if you have created an alignment of three sequences, the three sequences are shown here. Clicking the element selects it in the **Navigation Area**, and clicking the 'history' link opens the element's own history.

When an element's info is open you can check current information about the element, and in particular the potential association of the data you are looking at with metadata. To learn more about the **Show Element Info** button, see section 10.4 and see section 3.2.3.

2.1.4 Close views

When a view is closed, the **View Area** remains open as long as there is at least one open view.

A view is closed by:

right-click the tab of the View | Close

or **select the view | Ctrl + W**

or **hold down the Ctrl-button | Click the tab of the view while the button is pressed**

By right-clicking a tab, the following close options exist (figure 2.5).

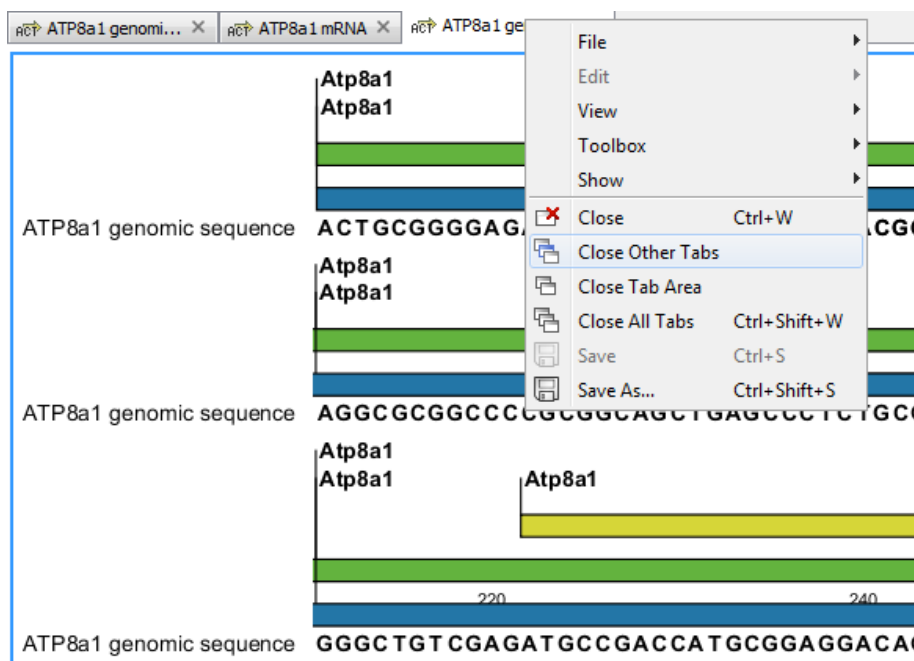

Figure 2.5: By right-clicking a tab, several close options are available.

- **Close.** See above.

- **Close Other Tabs.** Closes all other tabs, in all tab areas, except the one that is selected.
- **Close Tab Area.** Closes all tabs in the tab area.
- **Close All Tabs.** Closes all tabs, in all tab areas. Leaves an empty workspace.

2.1.5 Save changes in a view

When changes to an element are made in a view, the text on the tab appears *bold and italic* (on Mac it is indicated by an * before the name of the tab). This indicates that the changes are not saved. The **Save** function may be activated in two ways:

Click the tab of the view you want to save | Save () in the toolbar.

or **Click the tab of the view you want to save | Ctrl + S ( + S on Mac)**

If you close a tab of a view containing an element that has been changed since you opened it, you are asked if you want to save.

When saving an element from a new view that has not been opened from the **Navigation Area** (e.g. when opening a sequence from a list of search hits), a save dialog appears (figure 2.6).

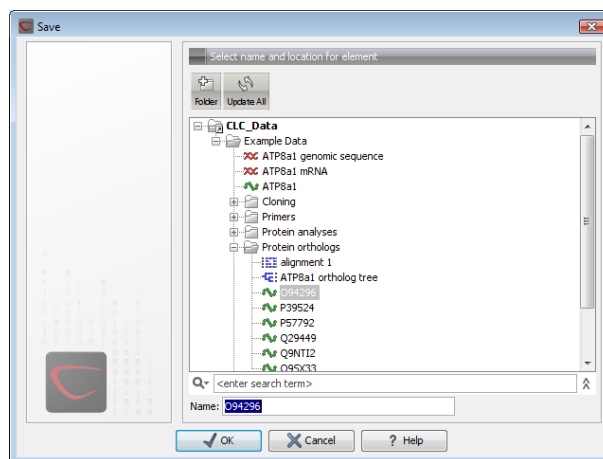

Figure 2.6: Save dialog.

In the dialog you select the folder in which you want to save the element.

After naming the element, press **OK**

2.1.6 Undo/Redo

If you make a change to an element in a view, e.g. remove an annotation in a sequence or modify a tree, you can undo the action. In general, **Undo** applies to all changes you can make when right-clicking in a view. **Undo** is done by:

Click undo () in the Toolbar

or **Edit | Undo ()**

or **Ctrl + Z**

If you want to undo several actions, just repeat the steps above. To reverse the undo action:

Click the redo icon in the Toolbaror **Edit | Redo** (↶)or **Ctrl + Y**

Note! Actions in the **Navigation Area**, e.g. renaming and moving elements, cannot be undone. However, you can restore deleted elements (see section 3.1.7).

You can set the number of possible undo actions in the Preferences dialog (see section 4).

2.1.7 Arrange views in View Area

To provide more space for viewing data, you can hide **Navigation Area** and the **Toolbox** by clicking the hide icon (⌵) at the top of the **Navigation Area**.

Views are arranged in the **View Area** by their tabs. The order of the **views** can be changed using drag and drop. E.g. drag the tab of one view onto the tab of another. The tab of the first view is now placed at the right side of the other tab.

If a tab is dragged into a view, an area of the view is made gray (see fig. 2.7) illustrating that the view will be placed in this part of the **View Area**.

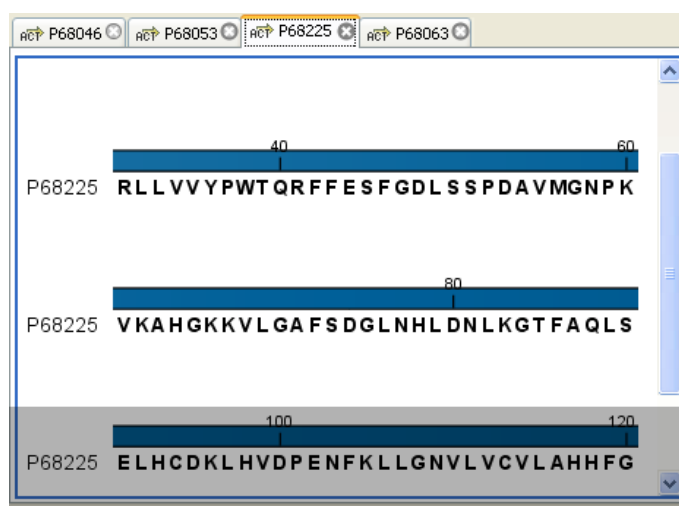

Figure 2.7: When dragging a view, a gray area indicates where the view will be shown.

The results of this action is illustrated in figure 2.8.

You can also split a **View Area** horizontally or vertically using the menus.

Splitting horizontally may be done this way:

right-click a tab of the view | View | Split Horizontally (≡)

This action opens the chosen view below the existing view. (See figure 2.9). When the split is made vertically, the new view opens to the right of the existing view.

Splitting the **View Area** can be undone by dragging e.g. the tab of the bottom view to the tab of the top view. This is marked by a gray area on the top of the view.

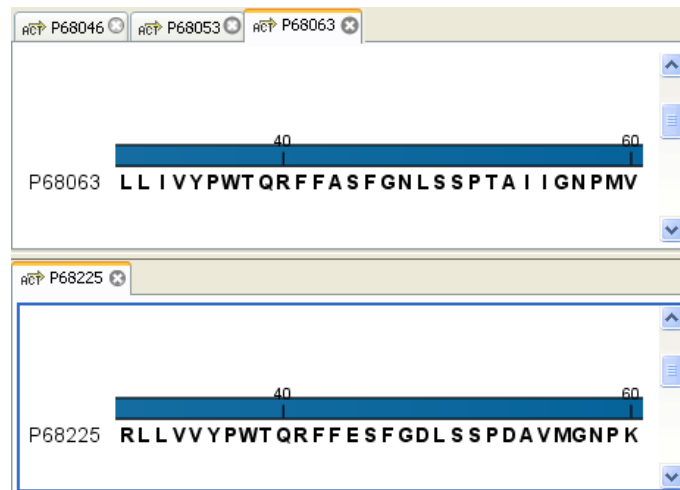

Figure 2.8: A horizontal split-screen. The two views split the View Area.

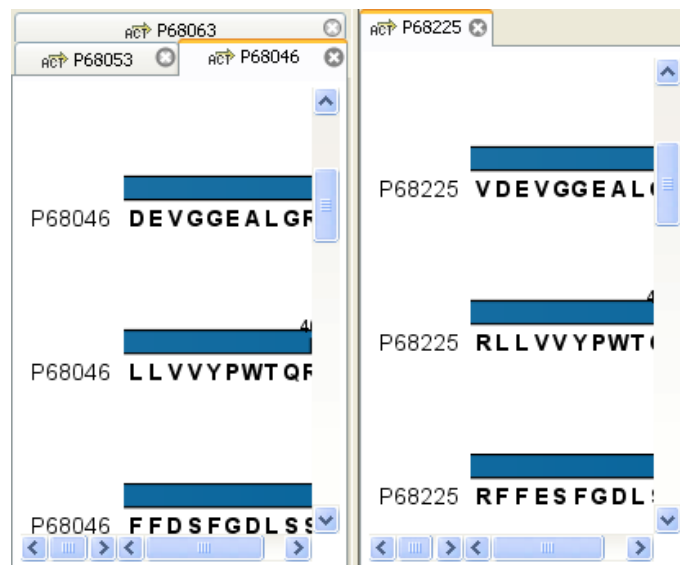

Figure 2.9: A vertical split-screen.

Maximize/Restore size of view

The **Maximize/Restore View** function allows you to see a view in maximized mode, meaning a mode where no other **views** nor the **Navigation Area** is shown.

Maximizing a view can be done in the following ways:

select view | Ctrl + M

or **select view | View | Maximize/restore View** ()

or **select view | right-click the tab | View | Maximize/restore View** ()

or **double-click the tab of view**

The following restores the size of the view:

Ctrl + M

or **View | Maximize/restore View** ()



Figure 2.10: A maximized view. The function hides the Navigation Area and the Toolbox.

or **double-click title of view**

Please note that you can also hide **Navigation Area** and the **Toolbox** by clicking the hide icon () at the top of the **Navigation Area**

2.1.8 Moving a view to a different screen

Using multiple screens can be a great benefit when analyzing data with the *CLC Genomics Workbench*. You can move a view to another screen by dragging the tab of the view and dropping it outside the workbench window. Alternatively, you can right-click in the view area or on the tab itself and select **View | Move to New Window** from the context menu.

An example is shown in figure 2.11, where the main Workbench window shows a table of open reading frames, and the screen to the right is used to display the sequence and annotations.

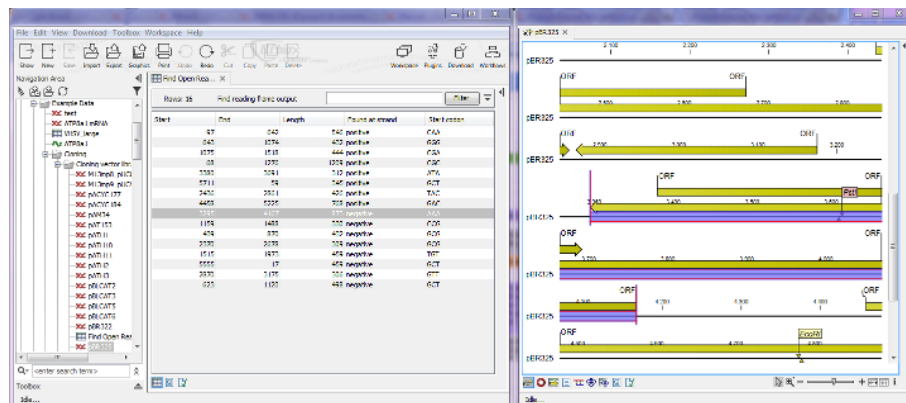

Figure 2.11: Showing the table on one screen while the sequence is displayed on another screen. Clicking the table of open reading frames causes the view on the other screen to follow the selection. Note that the screen resolution in this figure is kept low in order to include it in the manual; in a real scenario, the resolution will be much higher.

You can make more detached windows, by dropping tabs outside the open workbench windows, or you can drag more tabs to a detached window. To get a tab back to the main workbench window, just drag the detached tab back, and drop it next to the other tabs in the top of the view

area. **Note:** You should not drag the detached window header, just the tab itself.

You can also split the view area in the detached windows as described in section 2.1.7.

2.1.9 Side Panel

The **Side Panel** allows you to change the way the contents of a view are displayed. The options in the **Side Panel** depend on the kind of data in the view, and they are described in the relevant sections about sequences, alignments, trees etc.

Figure 2.12 shows the default **Side Panel** for a protein sequence. It is organized into *palettes*.

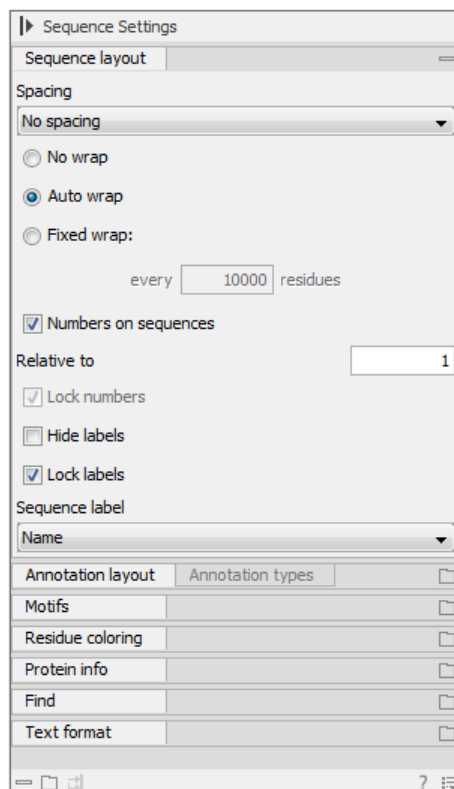

Figure 2.12: The default view of the Side Panel when opening a protein sequence.

In this example, there is one for Sequence layout, one for Annotation Layout etc. These palettes can be re-organized by dragging the palette name with the mouse and dropping it where you want it to be. They can either be situated next to each other, so that you can switch between them, or they can be listed on top of each other, so that expanding one of the palettes will push the palettes below further down.

In addition, they can be moved away from the **Side Panel** and placed anywhere on the screen as shown in figure 2.13.

In this example, the **Motifs** palette has been placed on top of the sequence view together with the **Protein info** and the **Residue coloring** palettes. In the **Side Panel** to the right, the **Find** palette has been put on top.

In order to make all palettes dock in the **Side Panel** again, click the **Dock Side Panel** icon (→|).

You can completely hide the **Side Panel** by clicking the **Hide Side Panel** icon (|▶).

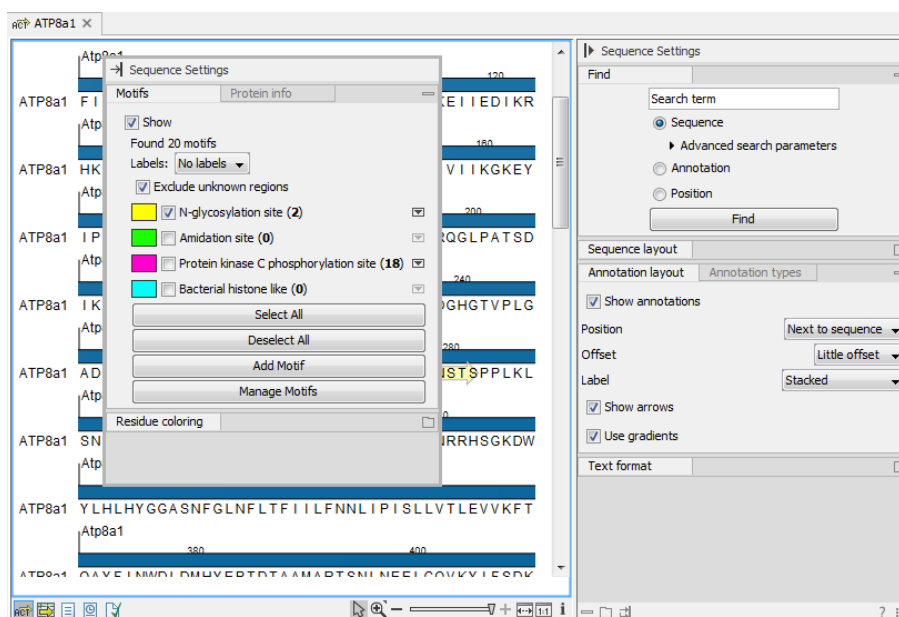

Figure 2.13: Palettes can be organized in the Side Panel as you like or placed anywhere on the screen.

At the bottom of the **Side Panel** (see figure 2.14) there are a number of icons used to:

- Expand all settings (☐).
- Collapse all settings (≡).
- Dock all palettes (☏)
- Get **Help** for the particular view and settings (?)
- Save the settings of the **Side Panel** or apply already saved settings. Read more in section 4.6

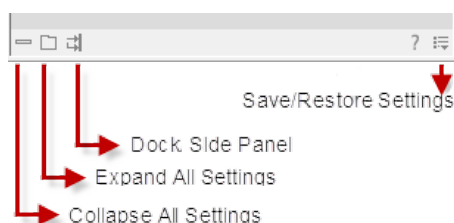

Figure 2.14: Controlling the Side Panel at the bottom

Note! Changes made to the **Side Panel**, including the organization of palettes will not be saved when you save the view. See how to save the changes in section 4.6

2.2 Zoom and selection in View Area

All views except tabular and text views support zooming. Figure 2.15 shows the zoom tools, located at the bottom right corner of the view.

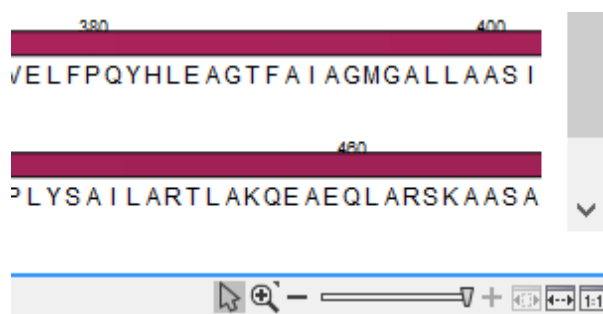







Figure 2.15: The zoom tools are located at the bottom right corner of the view.

The zoom tools consist of some shortcuts for zooming to fit the width of the view () , zoom to 100 % to see details () , zoom to a selection () , a zoom slider, and two mouse mode buttons () () .



The slider reflects the current zoom level and can be used to quickly adjust this. For more fine-grained control of the zoom level, move the mouse upwards while sliding.

The sections below describes how to use these tools as well as other ways of zooming and navigating data.

Please note that when working with protein 3D structures, there are specific ways of controlling zooming and navigation as explained in section [12.2](#).

2.2.1 Zoom in

There are six ways of **zooming in**:

- Click Zoom in mode () in the zoom tools (or press Ctrl+2) | click the location in the view that you want to zoom in on**
- or **Click Zoom in mode () in the zoom tools | click-and-drag a box around a part of the view | the view now zooms in on the part you selected**
- or **Press '+' on your keyboard**
- or **Move the zoom slider located in the zoom tools**
- or **Click the plus icon in the zoom tools**

The last option for zooming in is only available if you have a mouse with a scroll wheel:

- or **Press and hold Ctrl (⌘ on Mac) | Move the scroll wheel on your mouse forward**

Note! You might have to click in the view before you can use the keyboard or the scroll wheel to zoom.

If you press the **Shift** button on your keyboard while in zoom mode, the zoom function is reversed.

If you want to zoom in to 100 % to see the data at base level, click the **Zoom to base level** () icon.

2.2.2 Zoom out

It is possible to zoom out in different ways:

Click **Zoom out mode** (🔍) in the zoom tools (or press **Ctrl+3**) | click in the view

or **Press '-' on your keyboard**

or **Move the zoom slider located in the zoom tools**

or **Click the minus icon in the zoom tools**

The last option for zooming out is only available if you have a mouse with a scroll wheel:

or **Press and hold Ctrl (⌘ on Mac) | Move the scroll wheel on your mouse backwards**

Note! You might have to click in the view before you can use the keyboard or the scroll wheel to zoom.

If you want to zoom out to see all the data, click the **Zoom to Fit** (📏) icon.

If you press **Shift** while clicking in a **View**, the zoom function is reversed. Hence, clicking on a sequence in this way while the **Zoom out** mode toolbar item is selected, zooms in instead of zooming out.

2.2.3 Selecting, panning and zooming

In the zoom tools, you can control which mouse mode to use. The default is **Selection mode** (🖱️) which is used for selecting data in a view. Next to the selection mode, you can select the **Zoom in mode** as described in section 2.2.1. If you press and hold this button, two other modes become available as shown in figure 2.16:

- **Panning** (👤) is used for dragging the view with the mouse as a way of scrolling.
- **Zoom out** (🔍) is used to change the mouse mode so that whenever you click the view, it zooms out.

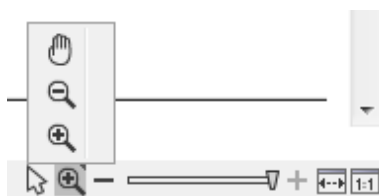

Figure 2.16: Additional mouse modes can be found in the zoom tools.

If you hold the mouse over the selection and zoom tools, tooltips will appear that provide further information about how to use the tools.

The mouse modes only apply when the mouse is within the view where they are selected.

The **Selection mode** can also be invoked with the keyboard shortcut **Ctrl+1**, while the **Panning mode** can be invoked with **Ctrl+4**.

For some views, if you have made a selection, there is a **Zoom to Selection** (📏) button, which allows you to zoom and scroll directly to fit the view to the selection.

2.3 Toolbox and Status Bar

The **Toolbox** is placed in the left side of the user interface of *CLC Genomics Workbench* below the **Navigation Area**.

The **Toolbox** shows a **Processes tab**, **Favorites tab** and a **Toolbox tab**.

The **Toolbox** can be hidden, so that the **Navigation Area** is enlarged and thereby displays more elements:

View | Show/Hide Toolbox | Show/Hide Toolbox

You can also click the **Hide Toolbox** (☰) button.

2.3.1 Processes

By clicking the **Processes** tab, the **Toolbox** displays previous and running processes, e.g. an NCBI search or a calculation of an alignment. The running processes can be stopped, paused, and resumed by clicking the small icon (☰) next to the process (see figure 2.17).

Running and paused processes are not deleted.

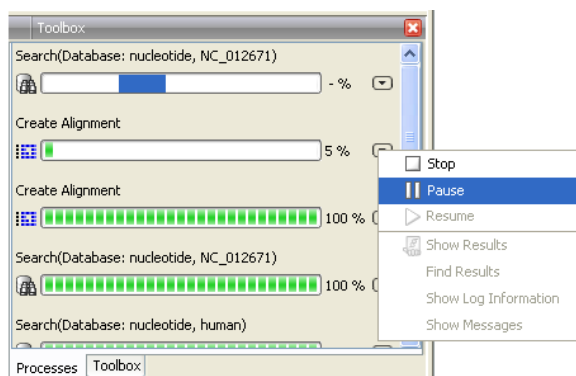

Figure 2.17: A database search and an alignment calculation are running. Clicking the small icon next to the process allow you to stop, pause and resume processes.

Besides the options to stop, pause and resume processes, there are some extra options for a *selected number* of the tools running from the Toolbox:

- **Show results.** If you have chosen to save the results (see section 8.2), you will be able to open the results directly from the process by clicking this option.
- **Find results.** If you have chosen to save the results (see section 8.2), you will be able to highlight the results in the Navigation Area.
- **Show Log Information.** This will display a log file showing progress of the process. The log file can also be shown by clicking **Show Log** in the "handle results" dialog where you choose between saving and opening the results.
- **Show Messages.** Some analyses will give you a message when processing your data. The messages are the black dialogs shown in the lower left corner of the Workbench that disappear after a few seconds. You can reiterate the messages that have been shown by clicking this option.

The terminated processes can be removed by:

View | Remove Finished Processes (X)

If you close the program while there are running processes, a dialog will ask if you are sure that you want to close the program. Closing the program will stop the process, and it cannot be restarted when you open the program again.

2.3.2 Toolbox

The content of the **Toolbox** tab in the **Toolbox** corresponds to **Toolbox** in the **Menu Bar**.

The tools in the toolbox can be accessed by double-clicking or by dragging elements from the **Navigation Area** to an item in the **Toolbox**.

Quick access to tools

A **Launch** button (🚀) enables quick launch of tools in *CLC Genomics Workbench*. You can also press **Ctrl + Shift + T** (⌘ + Shift + T on Mac) to show the quick launch dialog (see figure 2.18).

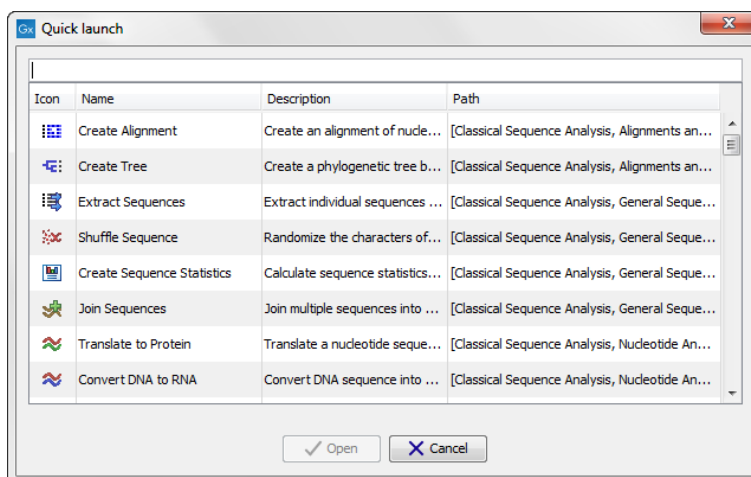

Figure 2.18: Quick access to all tools in **CLC Genomics Workbench**.

When the dialog is opened, you can start typing search text in the text field at the top. This will bring up the list of tools that match this text either in the name, description or location in the Toolbox. In the example shown in figure 2.19, typing `create` shows a list of tools involving the word "create", and the arrow keys or mouse can be used for selecting and starting a tool.

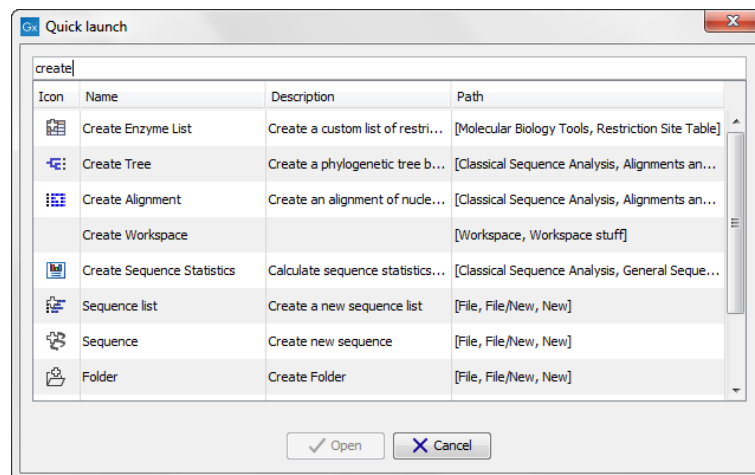

Figure 2.19: Typing in the search field at the top will filter the list of tools to launch.

Favorites toolbox

Next to the **Toolbox** tab, you find the **Favorites** tab. This can be used for organizing and getting quick access to the tools you use the most. It consists of two parts as shown in figure 2.20.

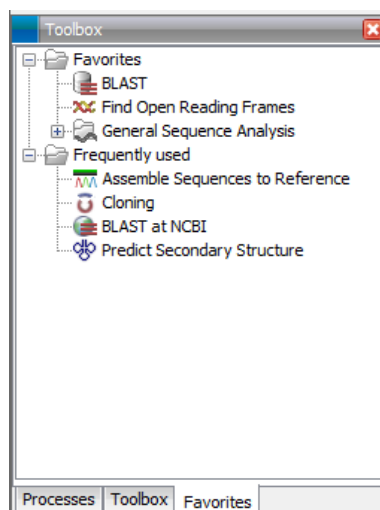

Figure 2.20: Favorites toolbox.

Favorites You can manually add tools to the favorites menu simply by right-clicking the tool in the Toolbox. You can also right-click the Favorites folder itself and select **Add Tool**. To remove a tool, right-click and select **Remove from Favorites**. Note that you can also add complete folders to the favorites.

Frequently used The list of tools in this folder is automatically populated as you use the Workbench. The most frequently used tools are listed at the top.

2.3.3 Status Bar

As can be seen from figure 2.1, the **Status Bar** is located at the bottom of the window. In the left side of the bar is an indication of whether the computer is making calculations or whether it is idle. The right side of the **Status Bar** indicates the range of the selection of a sequence. (See chapter 2.2.3 for more about the Selection mode button.)

2.4 Workspace

If you are working on a project and have arranged the views for this project, you can save this arrangement using **Workspaces**. A Workspace remembers the way you have arranged the views, and you can switch between different workspaces.

The **Navigation Area** always contains the same data across **Workspaces**. It is, however, possible to open different folders in the different **Workspaces**. Consequently, the program allows you to display different clusters of the data in separate **Workspaces**.

All **Workspaces** are automatically saved when closing down *CLC Genomics Workbench*. The next time you run the program, the **Workspaces** are reopened exactly as you left them.

Note! It is not possible to run more than one version of *CLC Genomics Workbench* at a time. Use two or more **Workspaces** instead.

2.4.1 Create Workspace

When working with large amounts of data, it might be a good idea to split the work into two or more **Workspaces**. As default the *CLC Genomics Workbench* opens one **Workspace**. Additional **Workspaces** are created in the following way:

Workspace in the Menu Bar | Create Workspace | enter name of Workspace | OK

When the new **Workspace** is created, the heading of the program frame displays the name of the new **Workspace**. Initially, the selected elements in the **Navigation Area** is collapsed and the **View Area** is empty and ready to work with. (See figure 2.21).



Figure 2.21: An empty Workspace.

2.4.2 Select Workspace

When there is more than one **Workspace** in the *CLC Genomics Workbench*, there are two ways to switch between them:

Workspace () in the Toolbar | Select the Workspace to activate

or **Workspace in the Menu Bar | Select Workspace () | choose which Workspace to activate | OK**

The name of the selected **Workspace** is shown after "*CLC Genomics Workbench*" at the top left corner of the main window, in figure 2.21 it says: (default).

2.4.3 Delete Workspace

Deleting a **Workspace** can be done in the following way:

Workspace in the Menu Bar | Delete Workspace | choose which Workspace to delete | OK

Note! Be careful to select the right **Workspace** when deleting. The delete action cannot be undone. (However, no data is lost, because a workspace is only a representation of data.)

It is not possible to delete the default workspace.

2.5 List of shortcuts

The keyboard shortcuts in *CLC Genomics Workbench* are listed below.

Action	Windows/Linux	Mac OS X
Adjust selection	Shift + arrow keys	Shift + arrow keys
Adjust workflow layout	Shift + Alt + L	⌘ + Shift + Alt + L
BLAST	Ctrl + Shift + L	⌘ + Shift + L
BLAST at NCBI	Ctrl + Shift + B	⌘ + Shift + B
Close	Ctrl + W	⌘ + W
Close all views	Ctrl + Shift + W	⌘ + Shift + W
Copy	Ctrl + C	⌘ + C
Create alignment	Ctrl + Shift + A	⌘ + Shift + A
Create track list	Ctrl + L	⌘ + L
Cut	Ctrl + X	⌘ + X
Delete	Delete	Delete or ⌘ + Backspace
Exit	Alt + F4	⌘ + Q
Export	Ctrl + E	⌘ + E
Export graphics	Ctrl + G	⌘ + G
Find Next Conflict	'.' (dot)	'.' (dot)
Find Previous Conflict	',' (comma)	',' (comma)
Help	F1	F1
Import	Ctrl + I	⌘ + I
Maximize/restore size of View	Ctrl + M	⌘ + M
Move gaps in alignment	Ctrl + arrow keys	⌘ + arrow keys
New Folder	Ctrl + Shift + N	⌘ + Shift + N
New Sequence	Ctrl + N	⌘ + N
Panning Mode	Ctrl + 4	⌘ + 4
Paste	Ctrl + V	⌘ + V
Print	Ctrl + P	⌘ + P
Redo	Ctrl + Y	⌘ + Y
Rename	F2	F2
Reverse zoom mode	press and hold Shift	press and hold Shift
Save	Ctrl + S	⌘ + S
Save As	Ctrl + Shift + S	⌘ + Shift + S
Scrolling horizontally	Shift + Scroll wheel	Shift + Scroll wheel
Search local data	Ctrl + Shift + F	⌘ + Shift + F
Search via Side Panel	Ctrl + F	⌘ + F
Search NCBI	Ctrl + B	⌘ + B
Search UniProt	Ctrl + Shift + U	⌘ + Shift + U
Select All	Ctrl + A	⌘ + A
Select Selection Mode	Ctrl + 1 (one)	⌘ + 1 (one)
Show folder content	Ctrl + O	⌘ + O
Show/hide Side Panel	Ctrl + U	⌘ + U
Sort folder	Ctrl + Shift + R	⌘ + Shift + R
Split Horizontally	Ctrl + T	⌘ + T
Split Vertically	Ctrl + J	⌘ + J
Start Tool Quick Launch	Ctrl + Shift + T	⌘ + Shift + T
Translate to Protein	Ctrl + Shift + P	⌘ + Shift + P
Undo	Ctrl + Z	⌘ + Z
Update folder	F5	F5
User Preferences	Ctrl + K	⌘ + ;

Action	Windows/Linux	Mac OS X
Vertical scroll in read tracks	Alt + Scroll wheel	Alt + Scroll wheel
Vertical scroll in reads tracks, fast	Shift+Alt+Scroll wheel	Shift+Alt+Scroll wheel
Vertical zoom in graph tracks	Alt + Scroll wheel	Alt + Scroll wheel
Workflow, add element	Alt + Shift + E	Alt + Shift + E
Workflow, collapse if its expanded	Alt + Shift + '-' (minus)	Alt + Shift + '-'
Workflow, create installer	Alt + Shift + I	Alt + Shift + I
Workflow, execute	Ctrl + enter	⌘ + enter
Workflow, expand if its collapsed	Alt + Shift + '+' (plus)	Alt + Shift + '+'
Workflow, highlight used elements	Alt + Shift + U	Alt + Shift + U
Workflow, remove all elements	Alt + Shift + R	Alt + Shift + R
Zoom	Ctrl + Scroll wheel	Ctrl + Scroll wheel
Zoom In Mode	Ctrl + 2	⌘ + 2
Zoom In (without clicking)	'+' (plus)	'+' (plus)
Zoom Out Mode	Ctrl + 3	⌘ + 3
Zoom Out (without clicking)	'-' (minus)	'-' (minus)
Zoom to base level	Ctrl + 0	⌘ + 0
Zoom to fit screen	Ctrl + 6	⌘ + 6
Zoom to selection	Ctrl + 5	⌘ + 5

Combinations of keys and mouse movements are listed below.

Action	Windows/Linux	Mac OS X	Mouse movement
Maximize View			Double-click the tab of the View
Restore View			Double-click the View title
Reverse zoom mode	Shift	Shift	Click in view
Select multiple elements that are not grouped together	Ctrl	⌘	Click elements
Select multiple elements that are grouped together	Shift	Shift	Click elements

"Elements" in this context refers to elements and folders in the **Navigation Area** selections on sequences, and rows in tables.

Chapter 3

Data management and search

Contents

3.1	Navigation Area	66
3.1.1	Data structure	66
3.1.2	Create new folders	69
3.1.3	Sorting folders	69
3.1.4	Multiselecting elements	69
3.1.5	Moving and copying elements	70
3.1.6	Change element names	71
3.1.7	Delete, restore and remove elements	72
3.1.8	Show folder elements in a table	73
3.2	Metadata	74
3.2.1	Importing Metadata	75
3.2.2	Associating data elements with metadata	82
3.2.3	Working with data and metadata	87
3.3	Working with tables	90
3.3.1	Filtering tables	91
3.4	Customized attributes on data locations	93
3.4.1	Configuring which fields should be available	93
3.4.2	Editing lists	95
3.4.3	Removing attributes	95
3.4.4	Changing the order of the attributes	95
3.4.5	Filling in values	96
3.4.6	What happens when a clc object is copied to another data location?	96
3.4.7	Searching	98
3.5	Local search	98
3.5.1	What kind of information can be searched?	98
3.5.2	Quick search	99
3.5.3	Advanced search	102
3.5.4	Search index	104

This chapter explains the data management features of *CLC Genomics Workbench*. The first section explains the basics of the data organization and the **Navigation Area**. The next section explains how to set up custom attributes for the data that can be used for more advanced data management. Finally, there is a section about how to search through local data.

3.1 Navigation Area

The **Navigation Area** is located in the left side of the screen, under the **Toolbar** (see figure 3.1). It is used for organizing and navigating data. Its behavior is similar to the way files and folders are usually displayed on your computer.

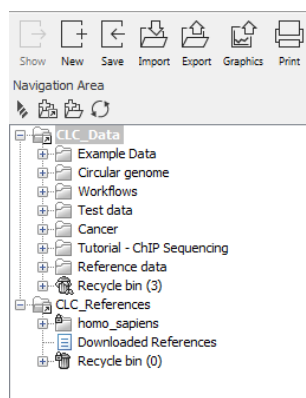



Figure 3.1: *The Navigation Area.*

To provide more space for viewing data, you can hide **Navigation Area** and the **Toolbox** by clicking the hide icon () at the top.

3.1.1 Data structure

The data in the **Navigation Area** is organized into a number of **Locations**. When the *CLC Genomics Workbench* is started for the first time, there is one location called *CLC_Data* (unless your computer administrator has configured the installation otherwise).

A location represents a folder on the computer: The data shown under a location in the **Navigation Area** is stored on the computer in the folder which the location points to.

This is explained visually in figure 3.2. The full path to the system folder can be located by mousing over the data location as shown in figure 3.3.

Adding locations

Per default, there is one location in the **Navigation Area** called *CLC_Data*. It points to the following folder:

- On Windows: `C:\Users\\CLC_Data`
- On Mac: `~/CLC_Data`
- On Linux: `/homefolder/CLC_Data`

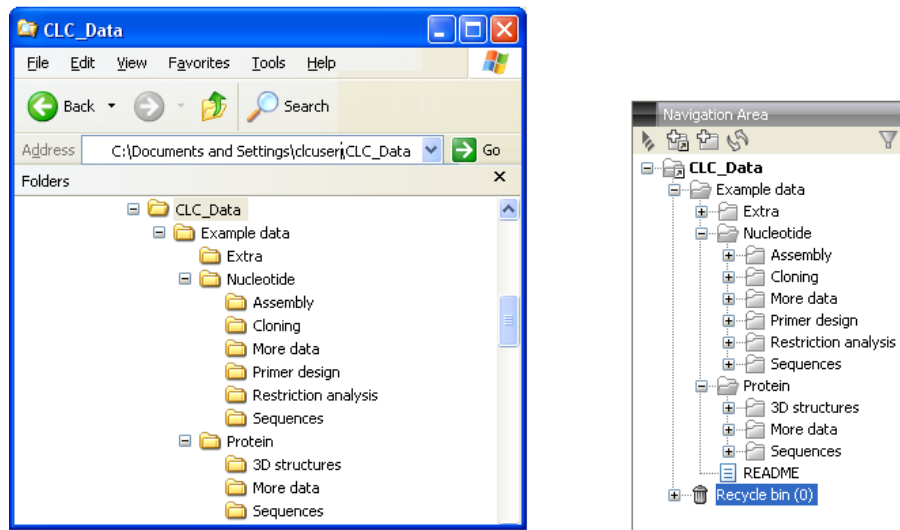

Figure 3.2: In this example the location called 'CLC_Data' points to the folder at C:\Documents and settings\clcuser\CLC_Data.

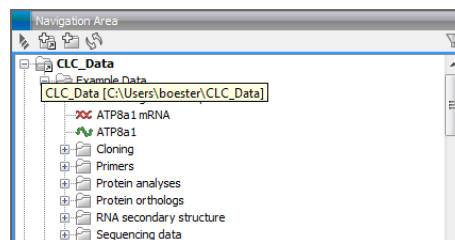

Figure 3.3: Mousing over the location called 'CLC_Data' shows the full path to the system folder, which in this case is C:\Users\boester\CLC_Data.

You can easily add more locations to the **Navigation Area**:

File | New | Location (📁)

This will bring up a dialog where you can navigate to the folder you wish to use as your new location (see figure 3.4).

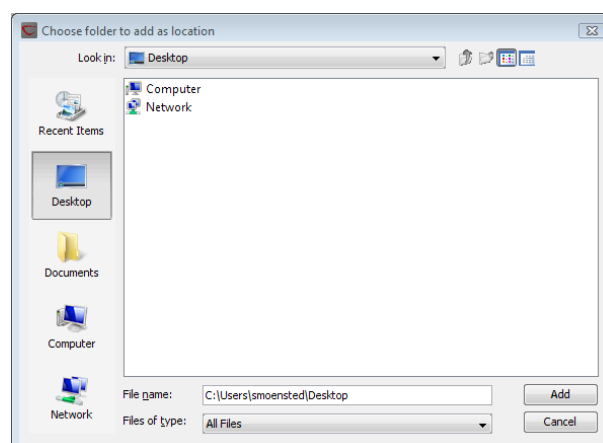

Figure 3.4: Navigating to a folder to use as a new location.

When you click **Open**, the new location is added to the **Navigation Area** as shown in figure 3.5.

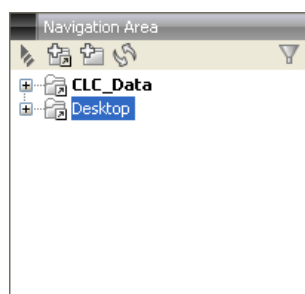

Figure 3.5: *The new location has been added.*

The name of the new location will be the name of the folder selected for the location. To see where the folder is located on your computer, place your mouse cursor on the location icon (📁) for a second. This will show the path to the location.

You can use a folder on a network drive or a removable drive as a Data Location. Such a location will appear inactive if the relevant drive is not available when you start up the Workbench. Once the drive is available, click on Update All (Image updates) and the relevant Data Location will become active (note that there might be a few seconds delay from the moment you connect).

Sharing data is possible when a network drive is available to multiple Workbenches. In this case, you can add the same folder as a Data Location on each Workbench. However, it is important to note that data sharing is not actively supported: we do not support concurrent alteration of data and while the software will often detect this situation and handle it appropriately, by for example only allowing read access to all but the one party editing the file, we do not guarantee this. In addition, any functionality that involves using the data search indices, (e.g. search functionality, associating metadata with data), will not work properly for shared data locations. Re-indexing a Data Location can help in the short term, but as soon as a new file is created by another piece of software, the index will be out of date. If you decide to share data via Workbenches this way, it is vital that any Workbench that adds a Data Location already used by other Workbenches uses as a Data Location **the exact same folder from the network drive file system hierarchy as the other Workbenches have used**. Indicating a folder higher up or lower down in the hierarchy will cause problems with the indexing of the files, meaning that newly created objects by Workbench A will not be found by Workbench B and vice versa.

Opening data

The elements in the **Navigation Area** are opened by:

Double-clicking on the element

or **Clicking once on the element | Show (📁) in the Toolbar**

or **Clicking once on the element | Right-click on the element | Show (📁)**

or **Clicking once on the element | Right-click on the element | Show (the one without an icon) | Select the desired way to view the element from the menu that appears when mousing over "Show"**

This will open a view in the **View Area**, which is described in section 2.1.

Adding data

Data can be added to the **Navigation Area** in a number of ways. Files can be imported from the file system (see chapter 6). Furthermore, an element can be added by dragging it into the **Navigation Area**. This could be views that are open, elements on lists, e.g. search hits or sequence lists, and files located on your computer. Finally, you can add data by adding a new location (see section 3.1.1).

If a file or another element is dropped on a folder, it is placed at the bottom of the folder. If it is dropped on another element, it will be placed just below that element.

If the element already exists in the **Navigation Area** a copy will be created with the name extension "-1", "-2" etc. if more than one copy exist.

3.1.2 Create new folders

In order to organize your files, they can be placed in folders. Creating a new folder can be done in two ways:

right-click an element in the Navigation Area | New | Folder 

or **File | New | Folder** 

If a folder is selected in the **Navigation Area** when adding a new folder, the new folder is added at the bottom of this folder. If an element is selected, the new folder is added right above that element.

You can move the folder manually by selecting it and dragging it to the desired destination.

3.1.3 Sorting folders

You can sort the elements in a folder alphabetically:

right-click the folder | Sort Folder

On Windows, subfolders will be placed at the top of the folder, and the rest of the elements will be listed below in alphabetical order. On Mac, both subfolders and other elements are listed together in alphabetical order.

3.1.4 Multiselecting elements

Multiselecting elements means that you select more than one element at the same time. This can be done in the following ways:

- Holding down the <Ctrl> key (⌘ on Mac) while clicking on multiple elements selects the elements that have been clicked.
- Selecting one element, and selecting another element while holding down the <Shift> key selects all the elements listed between the two locations (the two end locations included).
- Selecting one element, and moving the cursor with the arrow-keys while holding down the <Shift> key, enables you to increase the number of elements selected.

3.1.5 Moving and copying elements

Elements can be moved and copied in several ways:

- Using **Copy** (⌘), **Cut** (⌘) and **Paste** (⌘) from the **Edit** menu.
- Using Ctrl + C (⌘ + C on Mac), Ctrl + X (⌘ + X on Mac) and Ctrl + V (⌘ + V on Mac).
- Using **Copy** (⌘), **Cut** (⌘) and **Paste** (⌘) in the **Toolbar**.
- Using drag and drop to move elements.
- Using drag and drop while pressing Ctrl / Command to copy elements.

In the following, all of these possibilities for moving and copying elements are described in further detail.

Copy, cut and paste functions

Copies of elements and folders can be made with the copy/paste function which can be applied in a number of ways:

select the files to copy | right-click one of the selected files | Copy (⌘) | right-click the location to insert files into | Paste (⌘)

or **select the files to copy | Ctrl + C (⌘ + C on Mac) | select where to insert files | Ctrl + P (⌘ + P on Mac)**

or **select the files to copy | Edit in the Menu Bar | Copy (⌘) | select where to insert files | Edit in the Menu Bar | Paste (⌘)**

If there is already an element of that name, the pasted element will be renamed by appending a number at the end of the name.

Elements can also be moved instead of copied. This is done with the cut/paste function:

select the files to cut | right-click one of the selected files | Cut (⌘) | right-click the location to insert files into | Paste (⌘)

or **select the files to cut | Ctrl + X (⌘ + X on Mac) | select where to insert files | Ctrl + V (⌘ + V on Mac)**

When you have cut the element, it is "grayed out" until you activate the paste function. If you change your mind, you can revert the cut command by copying another element.

Note that if you move data between locations, the original data is kept. This means that you are essentially doing a copy instead of a move operation.

Move using drag and drop

Using drag and drop in the **Navigation Area**, as well as in general, is a four-step process:

click the element | click on the element again, and hold left mouse button | drag the element to the desired location | let go of mouse button

This allows you to:

- Move elements between different folders in the **Navigation Area**
- Drag from the **Navigation Area** to the **View Area**: A new view is opened in an existing **View Area** if the element is dragged from the **Navigation Area** and dropped next to the tab(s) in that **View Area**.
- Drag from the **View Area** to the **Navigation Area**: The element, e.g. a sequence, alignment, search report etc. is saved where it is dropped. If the element already exists, you are asked whether you want to save a copy. You drag from the **View Area** by dragging the tab of the desired element.

Use of drag and drop is supported throughout the program, also to open and re-arrange views (see section 2.1.7).

Note that if you move data between locations, the original data is kept. This means that you are essentially doing a copy instead of a move operation.

Copy using drag and drop

To copy instead of move using drag and drop, hold the Ctrl (⌘ on Mac) key while dragging:

click the element | click on the element again, and hold left mouse button | drag the element to the desired location | press Ctrl (⌘ on Mac) while you let go of mouse button release the Ctrl/⌘ button

3.1.6 Change element names

This section describes two ways of changing the names of sequences in the **Navigation Area**. In the first part, the sequences themselves are not changed - it's their representation that changes. The second part describes how to change the name of the element.

Change how sequences are displayed

Sequence elements can be displayed in the **Navigation Area** with different types of information:

- Name (this is the default information to be shown).
- Accession (sequences downloaded from databases like GenBank have an accession number).
- Latin name.
- Latin name (accession).
- Common name.
- Common name (accession).

Whether sequences can be displayed with this information depends on their origin. Sequences that you have created yourself or imported might not include this information, and you will only be able to see them represented by their name. However, sequences downloaded from databases like GenBank will include this information. To change how sequences are displayed:

**right-click any element or folder in the Navigation Area | Sequence Representation
| select format**

This will only affect sequence elements, and the display of other types of elements, e.g. alignments, trees and external files, will be not be changed. If a sequence does not have this information, there will be no text next to the sequence icon.

Rename element

Renaming a folder or an element in the **Navigation Area** can be done in two different ways:

select the element | Edit in the Menu Bar | Rename

or **select the element | F2**

When you can rename the element, you can see that the text is selected and you can move the cursor back and forth in the text. When the editing of the name has finished; press **Enter** or select another element in the **Navigation Area**. If you want to discard the changes instead, press the **Esc**-key.

For renaming annotations instead of folders or elements, see section [10.3.3](#).

3.1.7 Delete, restore and remove elements

When one deletes data from a data folder in the Workbench, it is moved to the recycle bin in that data location. Each data location has its own recycle bin. From the recycle bin, data can then be restored, or completely removed. Removal of data from the recycle bin frees disk space.

Deleting a folder or an element from a Workbench data location can be done in two ways:

right-click the element | Delete ()

or **select the element | press Delete key**

This will cause the element to be moved to the **Recycle Bin** () where it is kept until the recycle bin is emptied or until you choose to restore the data object to your data location.

For deleting annotations instead of folders or elements, see section [10.3.4](#).

Items in a recycle bin can be restored in two ways:

Drag the elements with the mouse into the folder where they used to be.

or **select the element | right click and choose the option Restore.**

Once restored, you can continue to work with that data.

All contents of the recycle bin can be removed by choosing to empty the recycle bin:

Edit in the Menu Bar | Empty Recycle Bin ()

This deletes the data and frees up disk space.



Note! This cannot be undone. Data is not recoverable after it is removed by emptying the recycle bin.

3.1.8 Show folder elements in a table

A location or a folder might contain large amounts of elements. It is possible to view their elements in the **View Area**:

select a folder or location | Show () in the Toolbar

or

select a folder or location | right click on the folder and select Show () | Contents ()

An example is shown in figure 3.6.

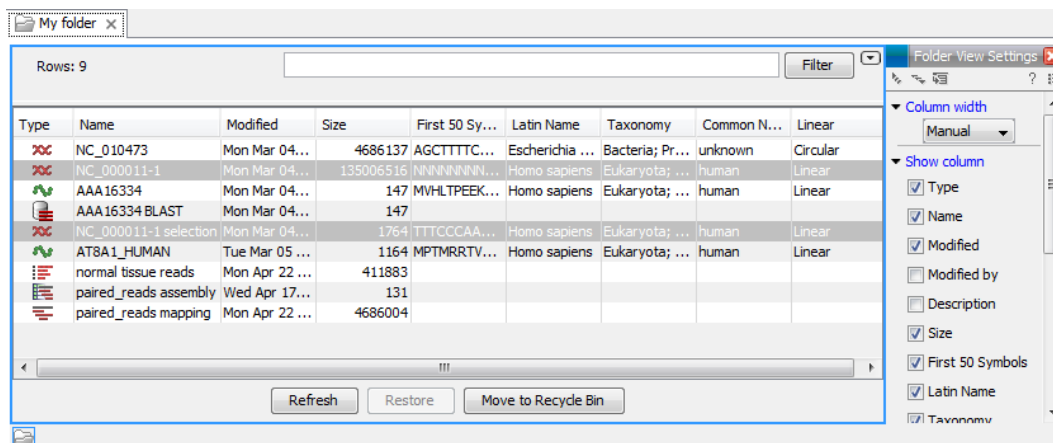

Figure 3.6: Viewing the elements in a folder.

When the elements are shown in the view, they can be sorted by clicking the heading of each of the columns. You can further refine the sorting by pressing Ctrl (⌘ on Mac) while clicking the heading of another column.

Sorting the elements in a view does not affect the ordering of the elements in the **Navigation Area**.

Note! The view only displays one "layer" at a time: the content of subfolders is not visible in this view. Also note that only sequences have the full span of information like organism etc.

Batch edit folder elements

You can select a number of elements in the table, right-click and choose **Edit** to batch edit the elements. In this way, you can change for example the description or name of several elements in one go.

In figure 3.7 you can see an example where the name of two sequence are renamed in one go. In this example, a dialog with a text field will be shown, letting you enter a new name for these two sequences.

Note! This information is directly saved and you cannot undo.

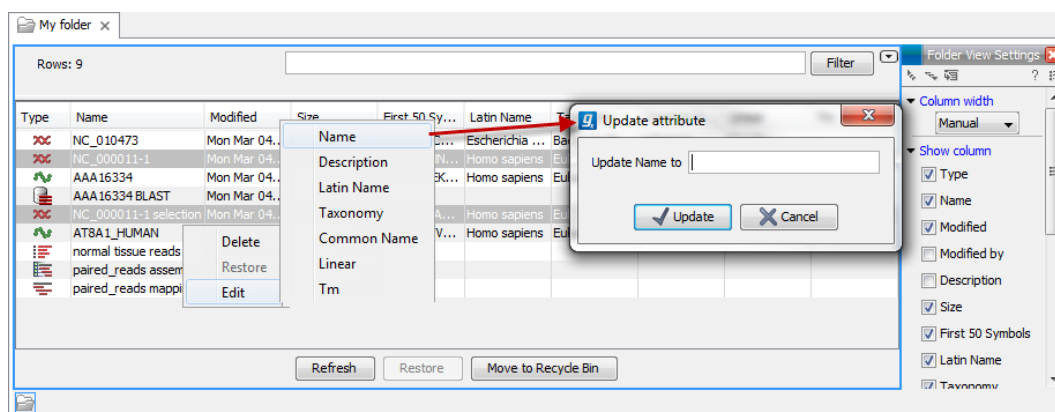

Figure 3.7: Changing the common name of two sequences.

Drag and drop folder elements

You can drag and drop objects from the folder editor to the **Navigation area**. This will create a copy of the objects at the selected destination. New elements can be included in the folder editor in the view area by dragging and dropping an element from a destination in the **Navigation Area** to the folder in the **Navigation Area** that you have open in the view area. It is not possible to drag elements directly from the **Navigation Area** to the folder editor in the View area.

3.2 Metadata

Metadata refers to information about data. In the context of the CLC Workbenches, this will usually mean information about samples. For example a set of reads could come from a particular specimen at a particular time point with particular characteristics. The specimen, time and characteristics would be metadata for that set of reads. The data can then be associated with its metadata in the Workbench. This can be useful for keeping track of related datasets and metadata can be used by some types of analyses in some CLC Workbenches.

Metadata can be created directly in the Workbench, but typically it will be imported from an external file (excel or text based). See section 3.2.1. It is then stored as a metadata table in the Workbench. An example of a metadata table as it might appear in the Workbench is shown in figure 3.8.

Sample ID	Tissue	Batch	Control
ETC-001	Liver	2	<input checked="" type="checkbox"/>
ETC-002	Liver	3	<input type="checkbox"/>
ETC-004	Brain	3	<input checked="" type="checkbox"/>
ETC-005	Liver	1	<input checked="" type="checkbox"/>
ETC-006	Brain	4	<input type="checkbox"/>
ETC-009	Brain	2	<input checked="" type="checkbox"/>
ETC-010	Liver	3	<input checked="" type="checkbox"/>
ETC-013	Brain	1	<input type="checkbox"/>

Figure 3.8: A simple Metadata Table.

Each column represents a property of a sample (e.g. identifier, height, age, treatment, etc.) and each row contain information relevant to a sample.

Within the CLC Workbench, one of the metadata table columns may be designated as the key column. The entries in a key column must be unique. Any column can be chosen to be the key column, but commonly it will be the first column and it would contain an identifier of some sort (e.g. a name).

There are no restrictions on the type of information that can be held in a metadata table. However, it is generally recommended that any given metadata table contains information about a related collection of entities. For example, a set of samples from the same experiment, or a set of families from the same study. Any particular data element can only be associated with *at most one* row in a given metadata table. However, that same data element can be associated with metadata in other metadata tables.

During or after metadata import, data can be associated with that metadata. Once a data element is associated with metadata, the outputs of analyses involving that data usually inherit the metadata association automatically. Inheritance like this is carried out when the metadata association for the outputs can be unambiguously identified. So, for example, if an output is derived from two inputs with different metadata associations, then neither association will be inherited by the output data elements.

Importing metadata can be done using a basic or advanced tool, and viewing and working with metadata, including data association, is done using the Metadata Table editor.

3.2.1 Importing Metadata

There are two tools that can be used to import metadata, one basic and one more advanced. A list of the benefits and limitations of each is included at the start the sections describing them.

Basic Metadata Import

The basic import tool is fast and easy, but less flexible than the advanced metadata import using the Metadata Table Editor. General features of this importer are:

- Excel (.xlsx/.xls) format files are imported.
- The first column in the Excel file must have unique entries. That column is designated the key column.
- Optionally, data elements can have associations to the metadata made.
- Metadata association using this tool matches data element names with the entries in the first column of the metadata being imported. Name matching can be based on exact or partial matches.
- Data elements that will be associated to metadata being imported are listed in a preview window.
- All columns are imported as text columns.

If desired, a metadata table can be edited later from within the Metadata Table editor as described in section 3.2.2. There, you can change the column data types (e.g. to types of numbers, dates, true/false) and you can designate a new key column.

To run the basic importer, go to:

File | Import (📄) | Import Metadata (📊)

In the box labeled **Spreadsheet with sample information**, select the Excel file (.xlsx/.xls) to be imported.

The rows in the spreadsheet are displayed in the Metadata preview window, as shown in figure 3.9. Click **Next**.

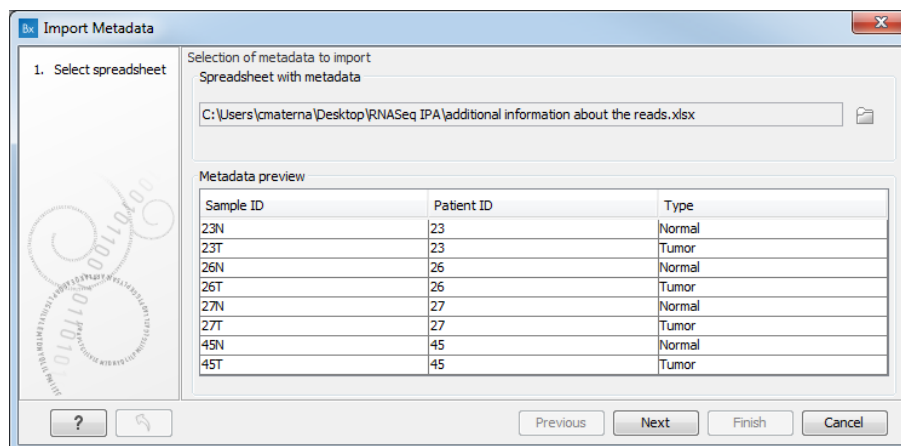

Figure 3.9: After an Excel file is selected, its rows are visible in the Metadata preview table.

The second wizard step, called "Associate with data", is optional. To proceed without associating data to metadata, click on the the button labeled **Next**.

Associating data with the metadata being imported is illustrated in figure 3.10. To do this:

- In the field labeled **Location of data**, click on the folder icon to the right and select the data elements of interest.
- In the Matching scheme section, select whether data element names must match exactly the entries in the first column of the metadata to have an association created (Exact), or whether partial matches are allowed (Partial). The two matching schemes are described in detail in section 3.2.2.

The Data association preview area shows data elements that will have associations created, along with information from the metadata row they are being linked with. This gives the opportunity to check that the matching is leading to the expected links between data and metadata.

- Click on the button labeled **Next**.
- Select where you wish the metadata table to be saved.
- Click on the button labeled **Finish**.

The associated information can be viewed for a given data element in the Show Element Info view, as show in figure 3.11.

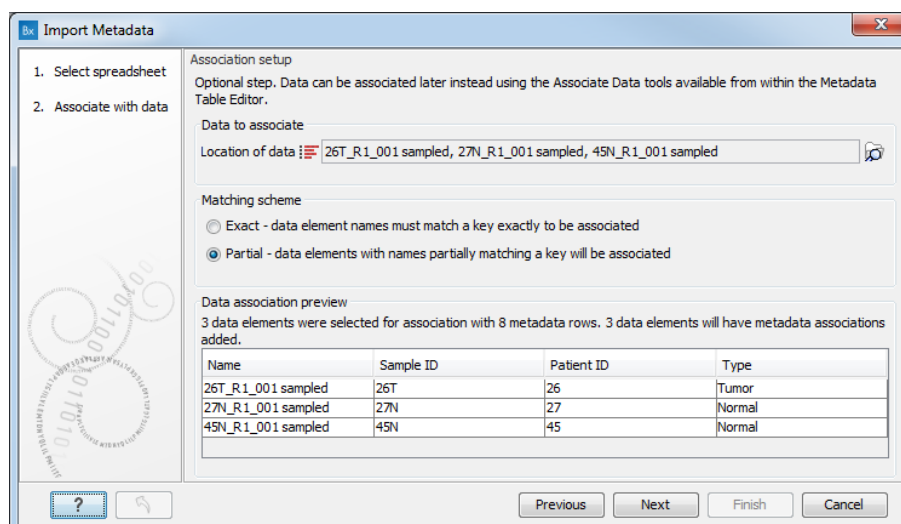

Figure 3.10: Three data elements were selected for association with 8 metadata rows. All three will have an associated added. Here, the partial matching scheme has been selected.

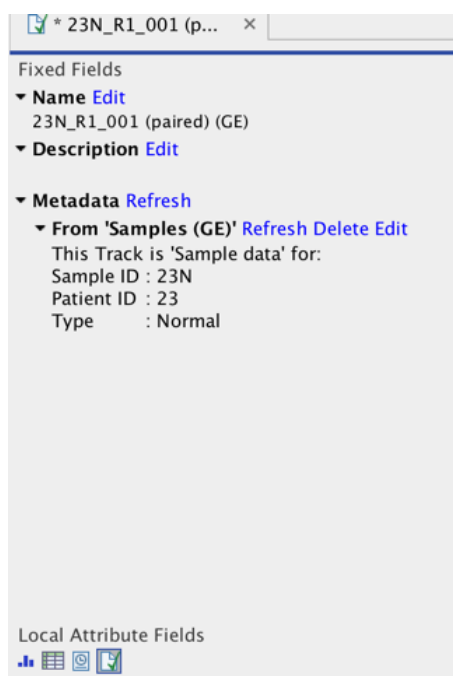

Figure 3.11: Metadata associations can be seen, edited, refreshed or deleted via the Show Element Info view.

Advanced Metadata Import

The Metadata Table Editor can be used to import metadata from an external file. It involves more steps than the basic import tool, but is more flexible and has some basic error checking associated with data types. General features of this importer are:

- Can import from Excel (.xlsx/.xls) or text files with a common delimiter can be used.
- The structure of the metadata table (the columns, their type, and the key column) must be set up before the metadata (contents) are imported.

- It is generally recommended that one column be designated as the key column. Entries in that column must have unique entries.
- The default data type for columns on creation is text, but this can be altered before import commences. When importing the metadata, an error will result if entries are found that do not match the expected data type.
- Association with metadata is done by matching data element names with the entries in the first column of the spreadsheet. Name matching can be based on exact or partial matches.
- Association of data with metadata is done as a separate step from import, providing flexibility. For example, if information in more than one column together uniquely identifies a sample, but the information within a single given column does not uniquely do so.
- Association of data with metadata can be done row by row if key column entries and the names of the relevant data elements are not related.

The Metadata Table Editor can also be used to create and populate a metadata table directly if desired.

Importing metadata using the Metadata Table Editor requires that the table structure is defined first. Information about how to do this is below. However, if the information about the data is in an excel file and the entries in the first column are unique, then the Import Metadata tool described in section 3.2.1 can be used to define the table and import the metadata in one step. That populated metadata table can then be opened in the Metadata Table Editor, where it can be refined, for example setting a new key column (or choosing not to have one), setting data types on columns, associating data as desired, and so on.

To set up a or alter a table structure using the Metadata Table Editor:

- Go to:

File | New | Metadata Table (📄)

This opens a new metadata table with no columns and no rows.

- Click on the button labeled **Setup Table** at the bottom of the view. A window appears like that shown in figure 3.12. The table structure will be defined using this tool.

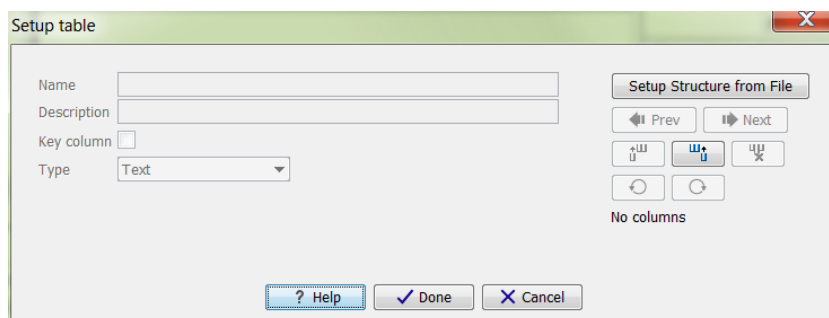

Figure 3.12: Dialog used to add columns to an empty Metadata Table.

- Click on the button labeled **Setup Structure from File**. A window will appear as shown in figure 3.13. You need to provide the following information:

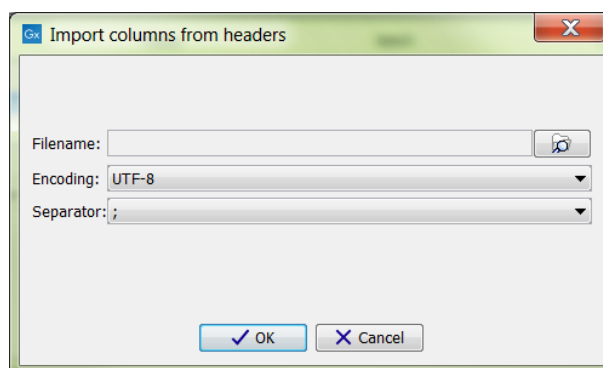

Figure 3.13: Creating a metadata table structure based on an external file.

- **Filename** The Excel or delimited text file to import. Column names should be in the first row of this file.
- **Encoding** For text files only: the encoding used to create the file. The default is UTF-8.
- **Separator** For text files only: The character used to separate the columns. The default is semicolon (;).

For each column in the external file, a column will be created in the new metadata table. By default the type of these imported columns is "Text". You will see a reminder to set the column type for each column and to designate one of the columns as the key column.

You may modify the following information for each column:

- **Name.** A mandatory header name or title for the column.
 - **Description.** An optional description of the information that will be held in the column. The description will appear as a tool tip, visible when you hover the mouse cursor over the column name in the metadata table.
 - **Key column.** Put a check in the box in the one column that will be the "key" column. All rows in this column must be populated and all entries in this column must be unique.
 - **Type.** The type of value allowed. The available types are:
 - * **Text** Simple text.
 - * **Whole number** Integer values, like 42 or -7.
 - * **Decimal number** Decimal values, like 3.14 or 1.72e13.
 - * **Yes / No** Yes/No or True/False values are accepted. Capitalization is not necessary.
 - * **Date** Local dates such as 2015-04-23 for April 23rd, 2015.
 - * **Date and time** Local date and time such as 2015-04-23 13:37 for 1:37pm on April 23rd, 2015. Note the use of 24-hour clock and that no time zone information is present.
- Navigate between the columns using the (◀) Prev and (▶) Next buttons, or by using left/right arrow keys with Alt key held down.
- Modifications made to a particular column take effect as you navigate to another column, or if you close the dialog using **Done**.
- The (↶) and (↷) buttons are used undo and redo changes respectively.
- When the columns have been configured, click on the button labeled **Done**.

The table structure can also be defined manually by clicking on the (U↑) button and defining each column in turn.

Columns may be deleted using the (U↓) button. After metadata has been imported, additional columns can be added to the table structure. This can be done by importing the altered structure from an external file, where any columns not already in the metadata table will be added. Alternatively, individual columns can be added using the (U↑) and (U↓) buttons, which insert new columns before and after the current column respectively.

The metadata table can then be populated by importing information from an external file. The column names in the metadata table in the Workbench will be matched with those in the external file to determine which values go into which cell. Only cell values in columns with an exact name match will be imported. If the file used contains columns not in the metadata table, the values in those columns will be ignored. Conversely, if the metadata table contains columns not present in the file, imported rows will have no values for those columns.

- Click on the button labeled **Manage Data** button at the bottom of the view. A window appears like that shown in in figure 3.14.

Figure 3.14: Tool for managing the metadata itself. Notice the button labeled *Import Rows from File*.

When working with an existing metadata table and adding extra rows, it is generally recommended that a key column be designated first. If a key column is not present, then all rows in the file will be imported. With no key column designated, if any rows from that file were imported into the same metadata table earlier, a duplicate row will be created. With a key column, rows with a new, unique entry for that column are added to the table and existing rows with a key entry in the file will be updated, incorporating any changes present in the file. Duplicate rows will not be created.

- Click on the button labeled **Import Rows from File** and select the external file of metadata. This brings up the window shown in figure 3.15.

The options presented in that window are:

- **File**. The file containing the metadata to import. This can be Excel (.xlsx/.xls) format or a delimited text file.
- **Encoding**. For text files only: The text encoding of the selected file. Specifying the correct encoding is important to ensure that the file is correctly interpreted.
- **Separator**. For text files only: the character used to separate columns in the file.

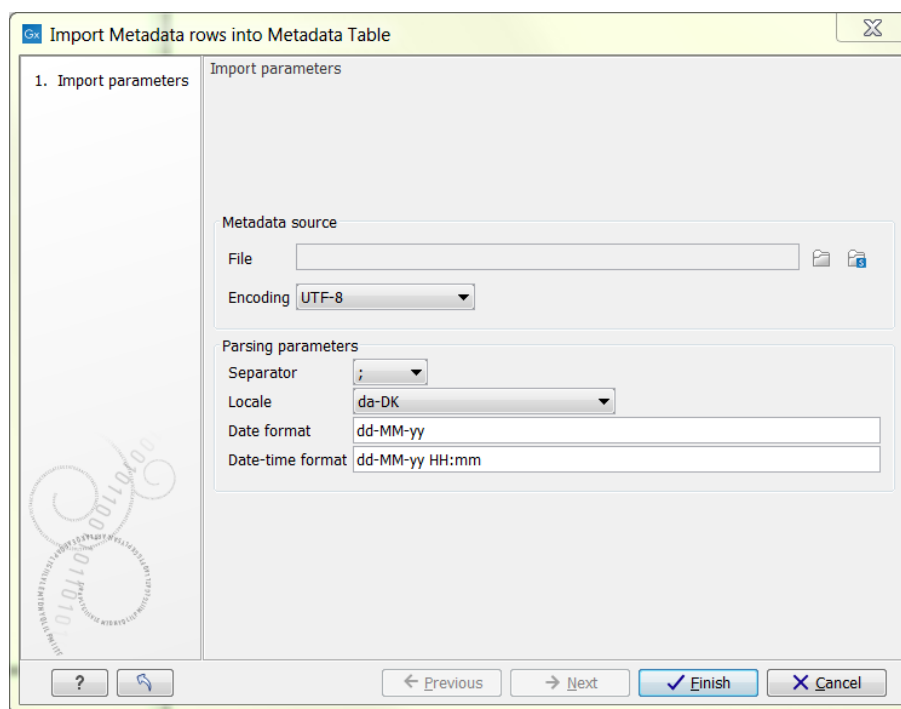

Figure 3.15: Tool to import rows into a Metadata Table.

- **Locale.** For text files only: the locale used to format numbers and dates within the file.
- **Date format.** For text files only: the date format used in the imported file.
- **Date-time format.** For text files only: the date-time format used in the imported file. The date and date-time templates uses the Java patterns for date and time formatting. Meaning of some of the symbols:

Symbol	Meaning	Example
y	Year	2004; 04
d	Day	10
M/L	Month	7; 07; Jul; July; J
a	am-pm	PM
h	Hour (0-12 am pm)	12
H	Hour (0-23)	0
m	Minute	30
s	Second	55

Examples of using this:

Format	Meaning	Example
dd-MM-yy	Short date	31-12-15
yyyy-MM-dd HH:mm	Date and Time	2015-11-23 23:35
yyyy-MM-dd'T'HH:mm	ISO 8601 (standard) format	2015-11-23T23:35

With a short year format (YY), 2000 will be added when imported as, or converted to, Date or Date and time format. Thus, when working with dates before the year 2000 or after 2099, please use a four digit format for the year (YYYY).

- Click the button labeled **Finish** button when the necessary fields have been filled in.

Row information can also be added manually by clicking on the  button and typing in the information for each column.

The progress and status of the row import can be seen in the Processes tab of the Toolbox. Any errors resulting from an import that failed can be reviewed here. The most frequent errors are associated with selecting the wrong separator or encoding, or wrong date/time formats when importing rows from delimited text files.

Once the rows are imported, The metadata table can be saved.

3.2.2 Associating data elements with metadata

Typically, one would use the tools described in this section to associate data elements with metadata just after the data has been imported. Doing this at this early stage means that analysis results generated using these inputs will often inherit the metadata association. This inheritance is done when the relevant association can be determined unambiguously.

Each association between a particular data element and a row in your Metadata Table will have a "role" label that indicates what the role of the data element has. For example, a newly import sequence list could be given a role like "Sample data", or "NGS reads". Each analysis tool provides a particular role label when applying a metadata association to the outputs it generates. For example, a read mapping tool could assign the role "Un-mapped reads" to a sequence list of unmapped reads that it produces. When viewing all the data associated with a given metadata entry, these roles can help distinguish the particular data elements of interest.

The metadata table must be saved before data association options are available to use.

To associate data elements with the rows of a Metadata Table, click the **Associate Data** button at the bottom of the Metadata Table view. When an metadata association is created for, or removed from, a data element, this change to the data element is automatically saved.

If a key column has been identified for the metadata table, two options will be available:

- **Association Data Automatically:** The whole metadata table is used and associations between the selected data elements and the metadata are applied based on matching of the element name with the key column entries in the metadata table.
- **Associate Data with Row:** You select a row of the metadata and a particular data element and an association is then created. Information in the metadata table does not need to match the name of the data elements using this option. This option is also available when right-clicking a row in the table.

Each of these has benefits and restrictions. These are described at the top of each sections describing these options.

Associate Data Automatically

The main characteristics of the **Associate Data Automatically** tool are:

- Suited to associated large metadata tables or associating to many data elements.
- Well suited for use with newly imported data, where no associations already exist.
- Associations are created based on matching the information in the key column of the metadata table with the name of the selected data elements.
- Two matching schemes are available: Exact and Partial (see section 3.2.2).
- A key column must be identified for the metadata table for this option to be available.
- Use with care with data elements that already have associations with the metadata table being worked with. As well as adding any new associations, existing associations will be *updated* to reflect the current information in the metadata table. This means associations will be *deleted* for a selected data element if there are no rows in the metadata table that match the name of that data element. See also the warning at the end of this section about this.

To run the **Associate Data Automatically** tool,

- Click the **Associate Data** button at the bottom of the Metadata Table view, and select **Associate Data Automatically**.

Your metadata table must be saved and a key column designated for the metadata table for this option to be available.

- Select the data the tool should consider when setting up metadata associations in the window that appears. An example of this is shown in figure 3.16. You can select an item or sets of items in the navigation area on the left and move these into the selected elements list. Alternatively, you can right click on a folder and specify that all elements in the folder should be put in the selected elements list. This is illustrated in figure 3.17.

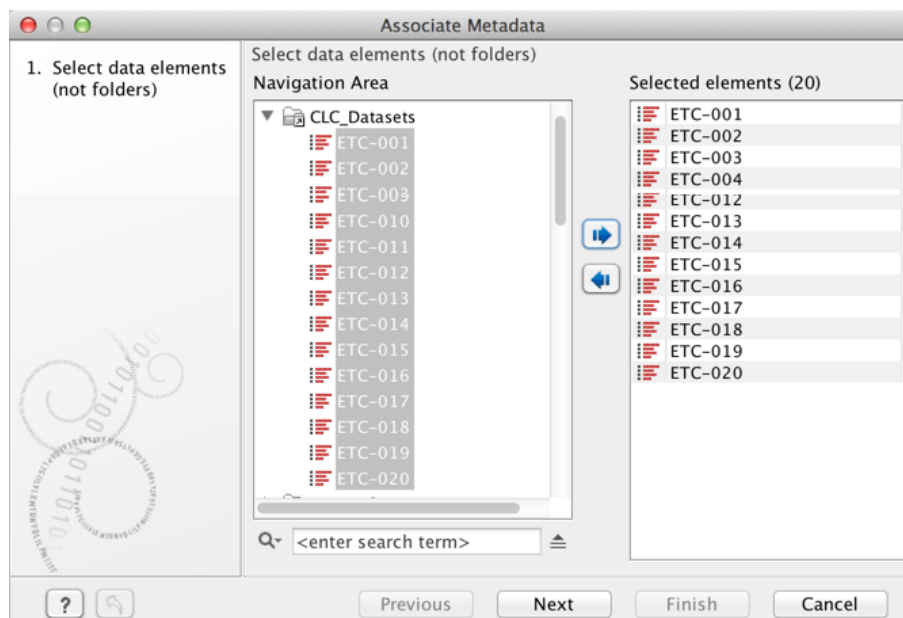

Figure 3.16: Select data for automatic metadata association.

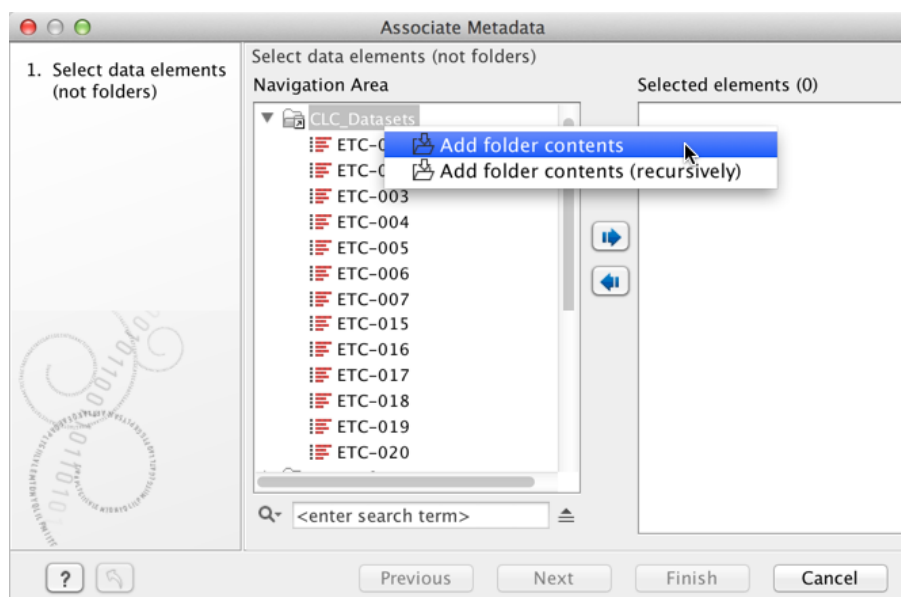

Figure 3.17: Selecting all data elements in a folder.

- Click on the button labeled **Next**.
- Specify a role that should be assigned to each data element that is associated to a metadata row (figure 3.18). The role can be anything that describes the data element best.

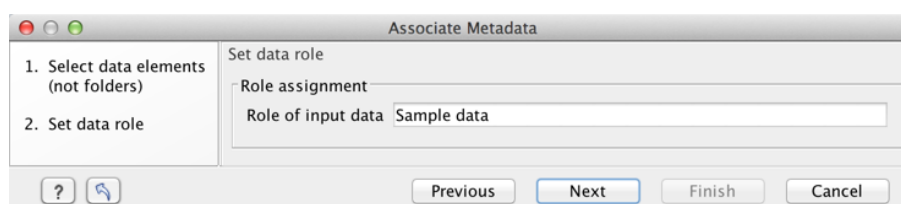

Figure 3.18: Provide a role for the data elements. The default role provided is "Sample data".

- Select whether the matching of the data element names to the entries in the key column should be based on exact or partial matching. These options are explained further below.

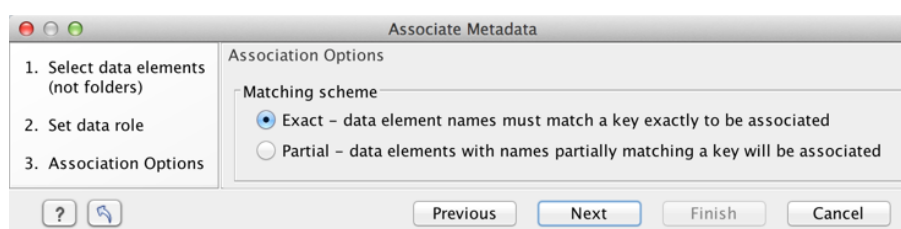

Figure 3.19: Data element names can be matched either exactly or partially to the entries in the key column.

- Click on the button labeled **Next** and then choose to **Save** the outputs.
Data associations and roles will be saved for data elements where the name matches a key column entry according to the selected matching scheme.

Warning: It is safest only to select data elements that have no existing association to the metadata table being worked with, or carefully selecting any data elements with an existing

association which you wish to update. All data selected that has an association with the metadata table being worked with will be *updated* by the automatic association tool. This means that any new or updated information in a metadata row can be added, but it also means that if no rows in the metadata match such a data element anymore, then the data association will be removed. This could happen if, for example, you changed the name of a data element with a metadata association, and did not change the corresponding key entry in the metadata table.

Matching schemes A data element name must match an entry in the key column of a metadata table for an association to be set up between that data element at the corresponding row of the metadata table. Two schemes are available in the **Association Data Automatically** for matching up names with key entries:

- Exact - data element names must match a key exactly to be associated. If any aspect of the key entry differs from the name of a selected data element, no association will be created.
- Partial - data elements with names partially matching a key will be associated. Here, data element names are broken into parts using common delimiters. The first whole part(s) must match a key entry in the metadata table for an association to be established. This option is explained in more detail below.

Partial matching rules For each data element being considered, the partial matching scheme involves breaking a data element name into components and searching for the best match from the key entries in the metadata table. In general terms, the best match means the longest key that matches entire components of the name.

The following describes the matching process in detail:

- Break the data element name into its component parts based on the presence of delimiters. It is these parts that are used for matching to the key entries of the metadata table.

Delimiters are any non-alphanumeric characters. That is, anything that is not a letter (a-z or A-Z) or number (0-9). So, for example, characters like hyphens (-), plus symbols (+), spaces, brackets, and so on, would be used as delimiters.

If partial matching was chosen with a data element called `Sample234-1 (mapped) (trimmed)` would be split into 4 parts: `Sample234`, `-1`, `(mapped)` and `(trimmed)`.

- Matches are made at the component level. A whole key entry must match perfectly to at least the first complete component of a data element name.

For example, a key entry `Sample234` would be a match to the data element with name `Sample234-1 (mapped) (trimmed)` because the whole key entry matches the whole of the first component of the data element name. Conversely, if the key entry had been `Sample23`, no match would be identified, because the whole key entry does not match to at least the whole of the first component of the data element name.

In cases where a data element could be matched to more than one key, the longest key matched determines the metadata row the data will be associated with.

The table below provides examples to illustrate the partial matching system, on a table that has the keys with sample IDs like in figure 3.20) (i.e. ETC-001, ETC-002, . . . , ETC-013),

Data Element	Key	Reason for association
ETC-001 (Reads)	ETC-001	Key ETC-001 matches the first part of the name
ETC-001 un-m. . . (single)	ETC-001	''
ETC-001 un-m. . . (paired)	ETC-001	''
ETC-002	ETC-002	Key ETC-002 matches the whole name
ETC-003	None	No keys match this data element name
ETC-005	ETC-005	Key ETC-005 matches the whole name
ETC-005-1	ETC-005	Key ETC-005 matches the first part of the name
ETC-006-5	ETC-006	Key ETC-006 matches the first part of the name
ETC-007	None	No keys match this data element name
ETC-007 (mapped)	None	''
ETC-008	None	''
ETC-008 (report)	None	''
ETC-009	ETC-009	Key ETC-009 matches the whole name

Associate Data with Row

The main characteristics of the **Associate Data with Row** tool are:

- Suited for association of a few metadata tables to a few data elements.
- Full control to select which data element should be associated with a particular metadata row.
- No requirement for a key column in the metadata table.
- No requirement for a relationship between the name of the data element and the metadata to associate it with.

To associate data elements with a particular row in the metadata table:

- Select the desired row in the metadata table by clicking on it.
- Right click and select the **Associate Data with Row** option (see figure 3.20), or click on the **Associate Data** button at the bottom of the view and choose the option **Associate Data with Row**.

The screenshot shows a table with 7 rows and 4 columns: Sample ID, Tissue, Batch, and Control. The row for ETC-006 (Brain, Batch 4) is selected. A context menu is open over this row, showing the option 'Associate Data with Row...'. Checkmarks are visible in the Control column for rows ETC-001, ETC-004, ETC-005, and ETC-009.

Sample ID	Tissue	Batch	Control
ETC-001	Liver	2	<input checked="" type="checkbox"/>
ETC-002	Liver	3	<input type="checkbox"/>
ETC-004	Brain	3	<input checked="" type="checkbox"/>
ETC-005	Liver	1	<input checked="" type="checkbox"/>
ETC-006	Brain	4	<input type="checkbox"/>
ETC-009	Brain	2	<input checked="" type="checkbox"/>
ETC-013	Brain	1	<input type="checkbox"/>

Figure 3.20: Manual association of data elements to a metadata row.

- A window will open within which you can select the data elements that should have an association with the metadata row.

If a selected data element already has an association with this particular metadata table, that association will be updated. Associations with any other metadata tables will be left as they are.

- Click on the button labeled **Next**.
- Enter a role for the data elements that have been chosen.
- Click on the button labeled **Next**.
- Click on the button labeled **Next** and then choose to **Save** the outputs.
Data associations and roles will be saved for the selected data elements.

3.2.3 Working with data and metadata

Finding data elements based on metadata

Using the Metadata Table view you can find data elements associated with rows of the metadata table. From this view, it is possible to launch analyses on selected data.

To find data elements associated with selected metadata rows:

- Select one or more rows of interest in the metadata table.
- Click on the button labeled **Find Associated Data** at the bottom of the view.

A table with a listing of the data elements associated to the selected metadata row(s) will appear (figure 3.21).

The screenshot shows a software interface with two main tables. The top table, titled 'Metadata', has 7 rows and 4 columns: Sample ID, Tissue, Batch, and Control. The bottom table, titled 'Metadata Elements', has 8 rows and 5 columns: Sample ID, Role, Type, Name, and Path. The 'Find Associated Data' button is highlighted in the interface.

Sample ID	Tissue	Batch	Control
ETC-001	Liver		2
ETC-002	Liver		3
ETC-004	Brain		3
ETC-005	Liver		1
ETC-006	Brain		44
ETC-009	Brain		2
ETC-013	Liver		1

Sample ID	Role	Type	Name	Path
ETC-001	Sample data	Reads	ETC-001 (Reads)	CLC_Data / Metadata / Example
ETC-001	Sample data	Reads	ETC-001 un-mapped reads (single)	CLC_Data / Metadata / Example
ETC-001	Sample data	Reads	ETC-001 un-mapped reads (paired)	CLC_Data / Metadata / Example
ETC-009	Un-mapped reads	Reads	BC_9_L001_R1 (paired) un-mapped reads [BC_9_L001_R1] (single)	CLC_Data
ETC-009	Un-mapped reads	Reads	BC_9_L001_R1 (paired) un-mapped reads [BC_9_L001_R1] (paired)	CLC_Data
ETC-009	Mapping Report	Reads	BC_9_L001_R1 (paired) mapping summary report	CLC_Data
ETC-009	Read mapping	Reads	BC_9_L001_R1 (paired) mapping	CLC_Data
ETC-009	Sample data	Reads	ETC-009	CLC_Data / Metadata / Example

Figure 3.21: Metadata Table with search results

The search results table shows the type, name, and navigation area path for each data element found. It also shows the key entry of the metadata table row with which the element is associated and the role of the data element for this metadata association. In figure 3.21, there are five data elements associated with sample ETC-009. Three are Sequence Lists, two of which have a role that tells us that they are un-mapped reads resulting from the Map Reads to Reference tool.

Clicking the **Refresh** button will re-run the search and refresh the search results table.

Click the button labeled **Close** to close the search table view.

Data elements listed in the search result table can be opened by clicking on the button labeled **Show** at the bottom of the view.

Alternatively, they can be highlighted in the Navigation Area by clicking the **Find in Navigation Area** button.

Analyses can be launched on the selected data elements:

- Directly. Right click on one of the selected elements, choose the menu option **Toolbox**, and navigate to the tool of interest. The data selected in the search results table will be listed as selected elements in the Wizard that appears.
- Via the Navigation area selection. Use the **Find in Navigation Area** button and then launch a tool in the **Toolbox**. The items that were selected in the Navigation area will be pre-selected in the Wizard that is launched.

If no data elements with associations are found and this is unexpected, please re-index the locations your data are stored in. This is described in section 3.5.4. For data held in a CLC Server location, an administrator will need to run the re-indexing. Information on this can be found in the CLC Server admin manual at http://resources.qiagenbioinformatics.com/manuals/clcserver/current/admin/index.php?manual=Rebuilding_index.html.

Identifying metadata rows without associated data

Using the Metadata Table view you can apply filters using the standard filtering tools shown at the top of the view as well as by using special metadata filtering in the **Additional Filtering** shown at the bottom. Using the special metadata filtering option **Show only Unassociated Rows**, you can filter the rows visible in the Metadata Table view so only the rows to which no data elements are associated are shown. If desired, these rows could then be used to launch one of the tools for associating data, described in section 3.2.2

This filter can be cancelled by clicking on the **Additional Filtering** button again and clicking on the **Show only Unassociated Rows** again. When the filter is active, it has a checkmark beside it. When it is inactive, it does not.

This filter can take a long time if many rows are shown in the table. When working with many rows, it can help if the full table is filtered using the general filters in advance, using the standard filters at the top of the table view. Alternatively you can pre-select some rows and filtering with the Additional filtering option **Filter to Selected Rows**. This filter can be applied multiple times. If the search takes too long, you can cancel it by unselecting the filter from the menu.

This filter can be cancelled by clicking on the **Additional Filtering** button again and clicking on the **Clear Selection Filter** option.

Viewing metadata associations

Metadata associations for a data element are shown in the Element Info view (section 10.4), see figure 3.22. To show Element Info,

right-click an element in the Navigation Area | Show | Element Info ()

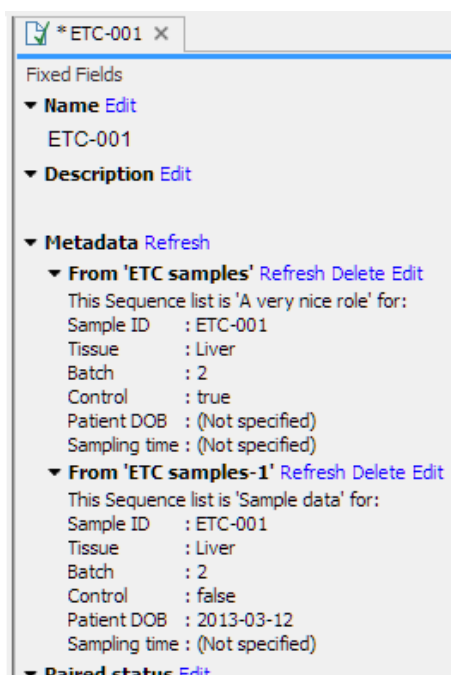

Figure 3.22: *Element Info* view with a metadata association

The Element Info view contains the details of each metadata association for the data element. The following operations are available:

- **Delete** will remove an association.
- **Edit** will allow you to change the role of the metadata association.
- **Refresh** will reload the metadata details from the Metadata Table; this functionality may be used to attempt to re-fetch metadata that was previously unavailable, e.g. due to server connectivity.

Removing metadata associations

Any or all associations to data elements from rows of a metadata table can be removed by taking the following steps:

1. Open the metadata table containing the rows of interest.
2. Highlight the relevant rows of the metadata table.
3. Click on the button labeled Find Associated Data.
4. In the Metadata Elements table that opens, highlight the rows for the data elements the metadata associations should be removed from.
5. Right click over the highlighted area and choose the option Remove Association(s) (figure 3.23). Alternatively, use the Delete key on the keyboard, or on a Mac, depress the fn and backspace keys at the same time.

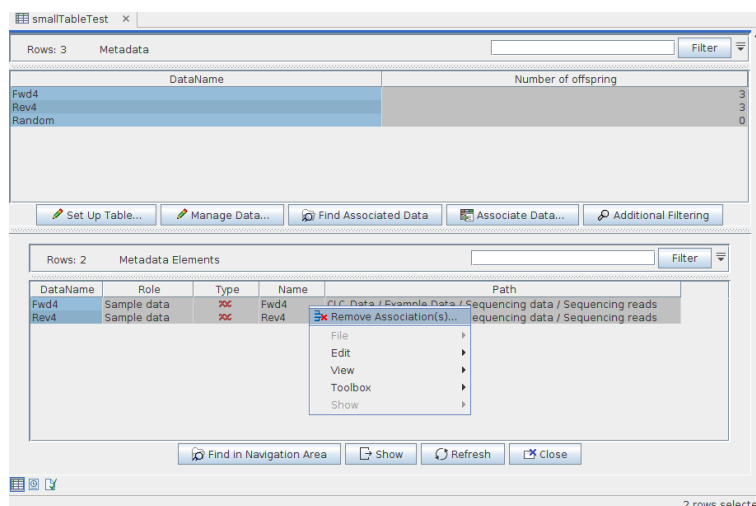

Figure 3.23: Removing metadata associations to two data elements via the Metadata Elements table.

Metadata associations can also be removed from within the Element info view for individual data elements, as described in section 3.2.3.

When a metadata association is removed from a data element, this update to the data element is automatically saved.

Exporting metadata

The standard Workbench export functionality can be used to export metadata tables to various formats. The system's default locale will be used for the export, which will affect the formatting of numbers and dates in the exported file.

See section 6.5 for more information.

3.3 Working with tables

Tables are used in a lot of places in the *CLC Genomics Workbench*. There are some general features for all tables, irrespective of their contents, that are described here.

Figure 3.24 shows an example of a typical table. This is the table result of **Find Open Reading Frames** (🔍). We use this table as an example to illustrate concepts relevant to all kinds of tables.

Table viewing options

Options relevant to the view of the table can be configured in the **Side Panel** on the right.

For example, the columns that can be displayed in the table are listed in the section called **Show column**. The checkboxes allow you to see or hide any of the available columns for that table.

The Column width can be set to **Automatic** or **Manual**. By default, the first time you open a table, it will be set to **Automatic**. The default selected columns are hereby resized to fit the width of the viewing area. When changing to the **Manual** option, column widths will adjust to the actual header size, and each column size can subsequently be adjusted manually. When the table

The screenshot shows a table with 34 rows and 7 columns. The columns are: Sequence, Start, End, Length, Found at strand, and Start codon. The rows list genomic sequences with their start and end coordinates, lengths, and strand orientations. The 'Table Settings' panel on the right allows for column width adjustment (set to 'Automatic') and shows a list of columns with checkboxes for visibility. All columns are currently checked.

Sequence	Start	End	Length	Found at strand	Start codon
ATP8a1 genomic sequence	18430	18747	318	positive	ATG
ATP8a1 genomic sequence	19414	19719	306	positive	ATG
ATP8a1 genomic sequence	54871	56568	1698	positive	ATG
ATP8a1 genomic sequence	92920	93231	312	positive	ATG
ATP8a1 genomic sequence	104521	104826	306	positive	ATG
ATP8a1 genomic sequence	136402	136773	372	positive	ATG
ATP8a1 genomic sequence	139531	139953	423	positive	ATG
ATP8a1 genomic sequence	152548	152871	324	positive	ATG
ATP8a1 genomic sequence	186019	186384	366	positive	ATG
ATP8a1 genomic sequence	7226	7582	357	positive	ATG
ATP8a1 genomic sequence	32537	32857	321	positive	ATG
ATP8a1 genomic sequence	54902	56518	1617	positive	ATG
ATP8a1 genomic sequence	76304	76642	339	positive	ATG
ATP8a1 genomic sequence	102089	102427	339	positive	ATG
ATP8a1 genomic sequence	169274	169849	576	positive	ATG
ATP8a1 genomic sequence	186452	186766	315	positive	ATG
ATP8a1 genomic sequence	54861	56594	1734	positive	ATG
ATP8a1 genomic sequence	95214	95522	309	positive	ATG
ATP8a1 genomic sequence	125520	125828	309	positive	ATG
ATP8a1 genomic sequence	132096	132647	552	positive	ATG
ATP8a1 genomic sequence	206397	206735	339	positive	ATG
ATP8a1 genomic sequence	222615	222920	306	positive	ATG
ATP8a1 genomic sequence	135831	136946	1116	negative	ATG
ATP8a1 genomic sequence	56598	57182	585	negative	ATG
ATP8a1 genomic sequence	31281	31619	339	negative	ATG
ATP8a1 genomic sequence	187208	187516	309	negative	ATG
ATP8a1 genomic sequence	132515	135790	3276	negative	ATG
ATP8a1 genomic sequence	131945	132511	567	negative	ATG
ATP8a1 genomic sequence	46934	47242	309	negative	ATG
ATP8a1 genomic sequence	178993	179358	366	negative	ATG
ATP8a1 genomic sequence	166075	166452	378	negative	ATG
ATP8a1 genomic sequence	160519	160878	360	negative	ATG
ATP8a1 genomic sequence	140920	141243	324	negative	ATG
ATP8a1 genomic sequence	127864	128187	324	negative	ATG

Figure 3.24: A table showing the results of an open reading frames analysis.

content exceeds the size of the viewing area, a horizontal scroll becomes available for navigation across the columns.

Sorting tables

You can **sort** table according to the values of a particular column by clicking a column header. (Pressing Ctrl - ⌘ on Mac - while you click will refine the existing sorting).

Clicking once will sort in ascending order. A second click will change the order to descending. A third click will set the order back its original order.

3.3.1 Filtering tables

The final concept to introduce is **Filtering**. The table filter as an advanced and a simple mode. The simple mode is the default and is applied simply by typing text or numbers (see an example in figure 3.25).¹

Typing "neg" in the filter will only show the rows where "neg" is part of the text in any of the columns (also the ones that are not shown). The text does not have to be in the beginning, thus "ega" would give the same result. This simple filter works fine for fast, textual and non-complicated filtering and searching.

However, if you wish to make use of numerical information or make more complex filters, you can switch to the advanced mode by clicking the **Advanced filter** (🔍) button. The advanced filter is structure in a different way: First of all, you can have more than one criterion in the filter. Criteria can be added or removed by clicking the **Add** (+) or **Remove** (✖) buttons. At the top, you can

¹Note that for tables with more than 10000 rows, you have to actually click the **Filter** button for the table to take effect.

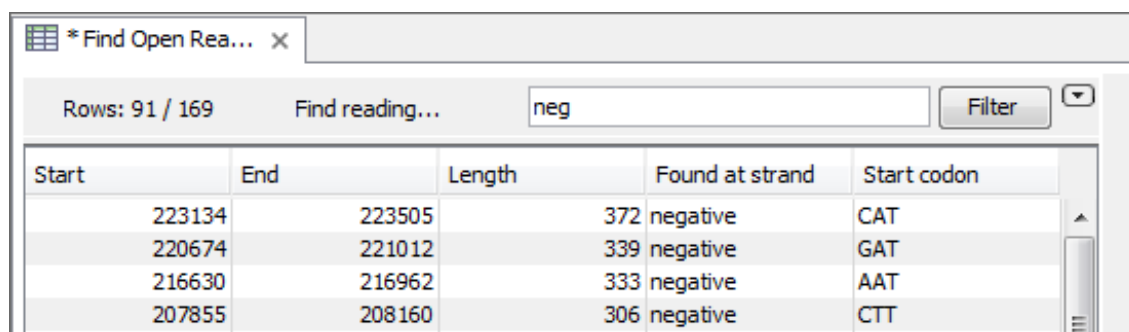

Start	End	Length	Found at strand	Start codon
223134	223505	372	negative	CAT
220674	221012	339	negative	GAT
216630	216962	333	negative	AAT
207855	208160	306	negative	CTT

Figure 3.25: Typing "neg" in the filter in simple mode.

choose whether all the criteria should be fulfilled (**Match all**), or if just one of the needs to be fulfilled (**Match any**).

For each filter criterion, you first have to select which **column** it should apply to.

Next, you choose an **operator**. For numbers, you can choose between:

- = (equal to)
- < (smaller than)
- > (greater than)
- <> (not equal to)
- **abs. value** < (absolute value smaller than. This is useful if it doesn't matter whether the number is negative or positive)
- **abs. value** > (absolute value greater than. This is useful if it doesn't matter whether the number is negative or positive)

Note, that the number of digits displayed is a formatting option which can be set in the View Preferences. The true number may well be (slightly) larger. This behaviour can lead to problems when filtering on exact matches using the = (equal to) operator on numbers. Instead, users are advised to use two filters of inequalities (< (smaller than) and > (greater than)) delimiting a (small) interval around the target value.

For text-based columns, you can choose between:

- **starts with** (the text starts with your search term)
- **contains** (the text does not have to be in the beginning)
- **doesn't contain**
- = (the whole text in the table cell has to match, also lower/upper case)
- ≠ (the text in the table cell has to not match)
- **is in list** (The text in the table cell has to match one of the items of the list. Items are separated by comma, semicolon, or space. This filter is not case-sensitive.)

- **is not in list** (The text in the table cell must not match any of the items of the list. Items are separated by comma, semicolon, or space. This filter is not case-sensitive)

Once you have chosen an operator, you can enter the **text or numerical value** to use.

The advanced filter criterion mentioned above are also available from a menu that appears by right-clicking on a value in a table: just specify the operator, and the column and value where you right-clicked for the menu to appear will define the two other fields of the advanced filter.

If you wish to reset the filter, simply remove (✖) all the search criteria. Note that the last one will not disappear - it will be reset and allow you to start over.

Figure 3.26 shows an example of an advanced filter which displays the open reading frames larger than 400 that are placed on the negative strand.

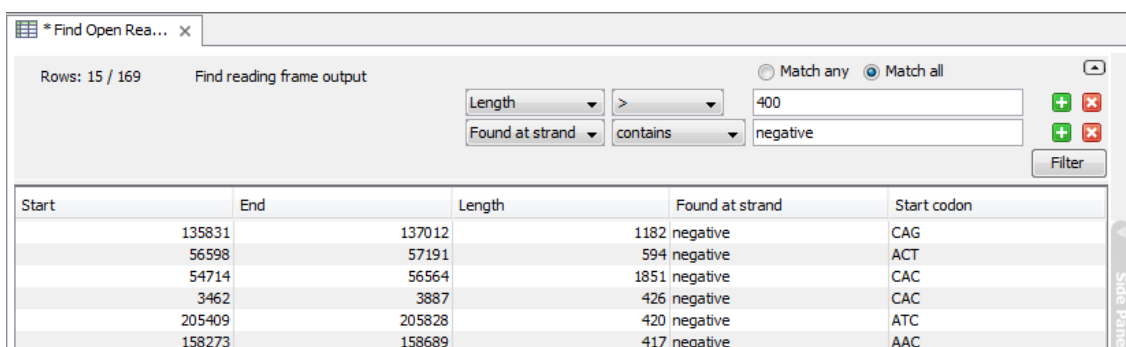

Start	End	Length	Found at strand	Start codon
135831	137012	1182	negative	CAG
56598	57191	594	negative	ACT
54714	56564	1851	negative	CAC
3462	3887	426	negative	CAC
205409	205828	420	negative	ATC
158273	158689	417	negative	AAC

Figure 3.26: The advanced filter showing open reading frames larger than 400 that are placed on the negative strand.

Both for the simple and the advanced filter, there is a counter at the upper left corner which tells you the number of rows that pass the filter (91 in figure 3.25 and 15 in figure 3.26).

3.4 Customized attributes on data locations

Location-specific attributes can be set on all elements stored in a given data location. Attributes could be things like company-specific information such as LIMS id, freezer position etc. Attributes are set using a CLC Workbench acting as a client to the CLC Server.

Note that the attributes scheme belongs to a particular data location, so if there are multiple data locations, each will have its own set of attributes.

3.4.1 Configuring which fields should be available

To configure which fields that should be available² go to the Workbench:

right-click the data location | Location | Attribute Manager

This will display the dialog shown in figure 3.27.

Click the **Add Attribute** (+) button to create a new attribute. This will display the dialog shown in figure 3.28.

²If the data location is a server location, you need to be a server administrator to do this

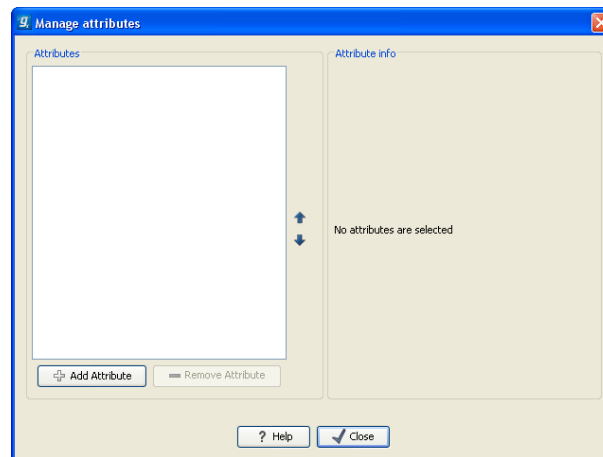

Figure 3.27: Adding attributes.

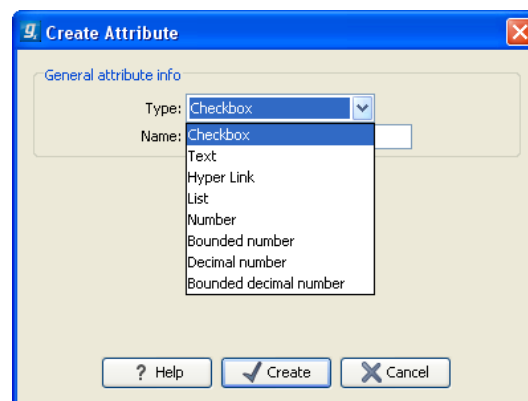

Figure 3.28: The list of attribute types.

First, select what kind of attribute you wish to create. This affects the type of information that can be entered by the end users, and it also affects the way the data can be searched. The following types are available:

- **Checkbox.** This is used for attributes that are binary (e.g. true/false, checked/unchecked and yes/no).
- **Text.** For simple text with no constraints on what can be entered.
- **Hyper Link.** This can be used if the attribute is a reference to a web page. A value of this type will appear to the end user as a hyper link that can be clicked. Note that this attribute can only contain one hyper link. If you need more, you will have to create additional attributes.
- **List.** Lets you define a list of items that can be selected (explained in further detail below).
- **Number.** Any positive or negative integer.
- **Bounded number.** Same as number, but you can define the minimum and maximum values that should be accepted. If you designate some kind of ID to your sequences, you can use the bounded number to define that it should be at least 1 and max 99999 if that is the range of your IDs.
- **Decimal number.** Same as number, but it will also accept decimal numbers.

- **Bounded decimal number.** Same as bounded number, but it will also accept decimal numbers.

When you click **OK**, the attribute will appear in the list to the left. Clicking the attribute will allow you to see information on its type in the panel to the right.

3.4.2 Editing lists

Lists are a little special, since you have to define the items in the list. When you click a list in the left side of the dialog, you can define the items of the list in the panel to the right by clicking **Add Item (+)** (see figure 3.29).

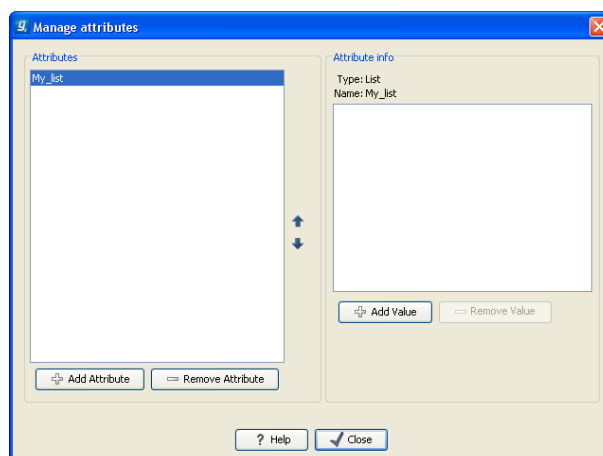

Figure 3.29: Defining items in a list.

Remove items in the list by pressing **Remove Item (-)**.

3.4.3 Removing attributes

To remove an attribute, select the attribute in the list and click **Remove Attribute (-)**. This can be done without any further implications if the attribute has just been created, but if you remove an attribute where values have already been given for elements in the data location, it will have implications for these elements: The values will not be removed, but they will become static, which means that they cannot be edited anymore.

If you accidentally removed an attribute and wish to restore it, this can be done by creating a new attribute of exactly the same name and type as the one you removed. All the "static" values will now become editable again.

When you remove an attribute, it will no longer be possible to search for it, even if there is "static" information on elements in the data location.

Renaming and changing the type of an attribute is not possible - you will have to create a new one.

3.4.4 Changing the order of the attributes

You can change the order of the attributes by selecting an attribute and click the **Up** and **Down** arrows in the dialog. This will affect the way the attributes are presented for the user.

3.4.5 Filling in values

When a set of attributes has been created (as shown in figure 3.30), the end users can start filling in information.

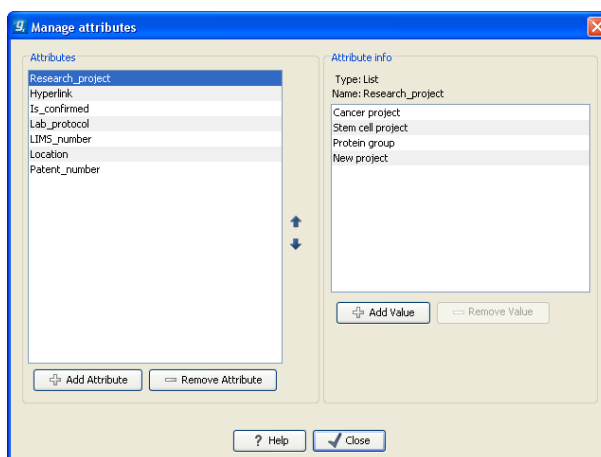

Figure 3.30: A set of attributes defined in the attribute manager.

This is done in the element info view:

right-click a sequence or another element in the Navigation Area | Show (📄) | Element info (📄)

This will open a view similar to the one shown in figure 3.31.

You can now enter the appropriate information and **Save**. When you have saved the information, you will be able to search for it (see below).

Note that the element (e.g. sequence) needs to be saved in the data location before you can edit the attribute values.

When nobody has entered information, the attribute will have a "Not set" written in red next to the attribute (see figure 3.32).

This is particularly useful for attribute types like checkboxes and lists where you cannot tell, from the displayed value, if it has been set or not. Note that when an attribute has not been set, you cannot search for it, even if it looks like it has a value. In figure 3.32, you will *not* be able to find this sequence if you search for research projects with the value "Cancer project", because it has not been set. To set it, simply click in the list and you will see the red "Not set" disappear.

If you wish to reset the information that has been entered for an attribute, press "Clear" (written in blue next to the attribute). This will return it to the "Not set" state.

The **Folder editor**, invoked by pressing **Show** on a given folder from the context menu, provides a quick way of changing the attributes of many elements in one go (see section 3.1.8).

3.4.6 What happens when a clc object is copied to another data location?

The user supplied information, which has been entered in the **Element info**, is attached to the attributes that have been defined in this particular data location. If you copy the sequence to another data location or to a data location containing another attribute set, the information will become fixed, meaning that it is no longer editable and cannot be searched for. Note that

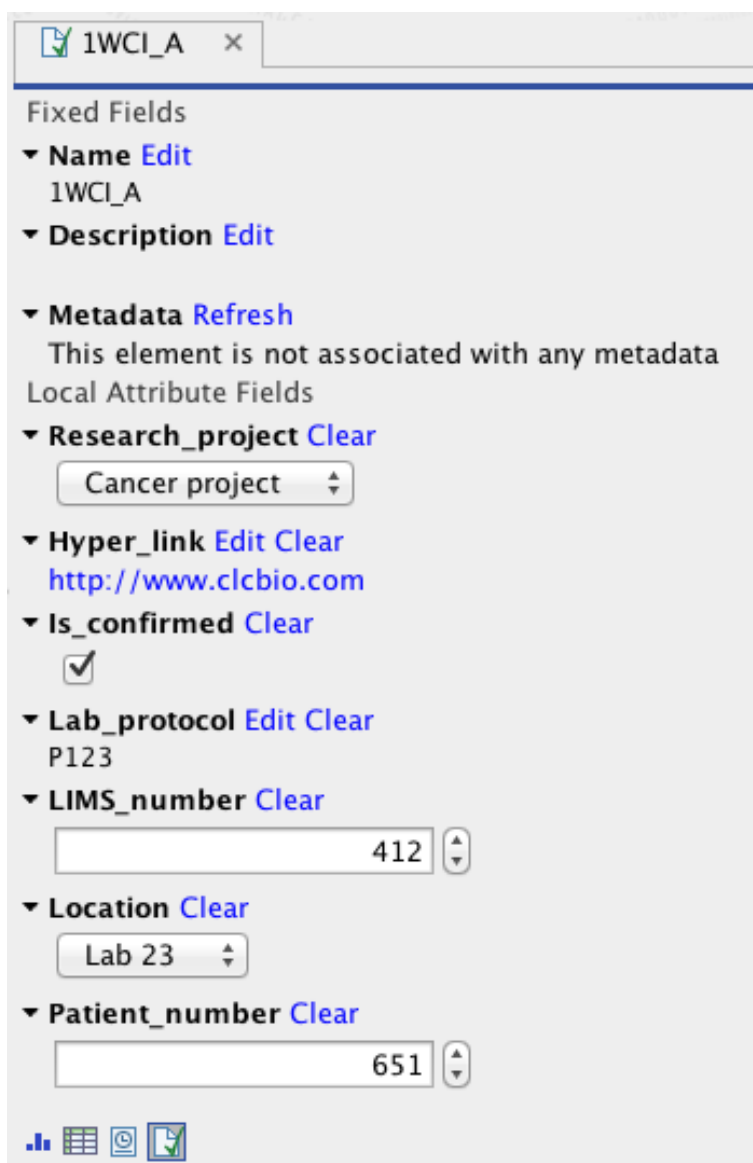

Figure 3.31: Adding values to the attributes.

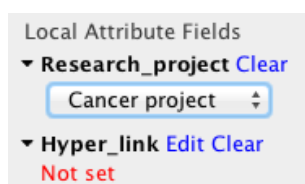

Figure 3.32: An attribute which has not been set.

attributes that were "Not set" will disappear when you copy data to another location.

If the element (e.g. sequence) is moved back to the original data location, the information will again be editable and searchable.

If the e.g. Molecule Project or Molecule Table is moved back to the original data location, the information will again be editable and searchable.

3.4.7 Searching

When an attribute has been created, it will automatically be available for searching. This means that in the **Local Search** (🔍), you can select the attribute in the list of search criteria (see figure 3.33).

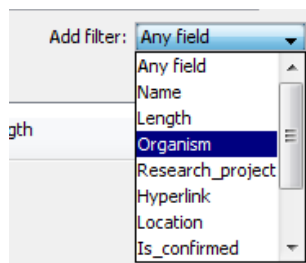

Figure 3.33: The attributes from figure 3.30 are now listed in the search filter.

It will also be available in the **Quick Search** below the **Navigation Area** (press Shift+F1 (Fn+Shift+F1 on Mac) and it will be listed - see figure 3.34).

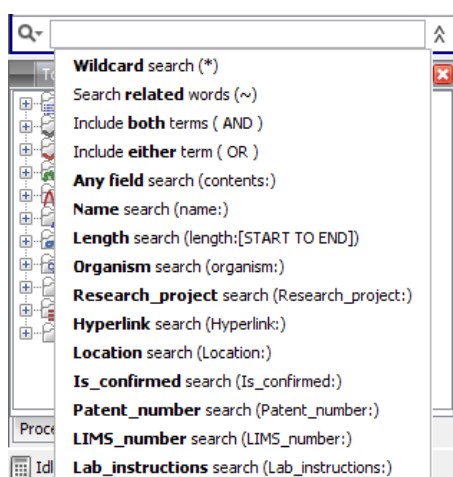

Figure 3.34: The attributes from figure 3.30 are now available in the Quick Search as well.

3.5 Local search

There are two ways of doing text-based searches of your data, as described in this section:

- **Quick-search** directly from the search field in the **Navigation Area**.
- **Advanced search** which makes it easy to make more specific searches.

In most cases, quick-search will find what you need, but if you need to be more specific in your search criteria, the advanced search is preferable.

3.5.1 What kind of information can be searched?

Below is a list of the different kinds of information that you can search for (applies to both quick-search and the advanced search).

- **Name.** The name of a sequence, an alignment or any other kind of element. The name is what is displayed in the **Navigation Area** per default.
- **Length.** The length of the sequence.
- **Organism.** Sequences which contain information about organism can be searched. In this way, you could search for e.g. *Homo sapiens* sequences.
- **Custom attributes.** Read more in section 3.4

Only the first item in the list, **Name**, is available for all kinds of data. The rest is only relevant for sequences.

If you wish to perform a search for sequence similarity, use Local BLAST (see section 11.1.3) instead.

3.5.2 Quick search

At the bottom of the **Navigation Area** there is a text field as shown in figure 3.35).

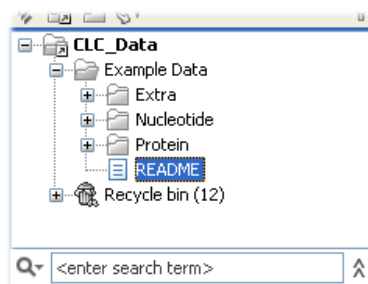

Figure 3.35: Search simply by typing in the text field and press Enter.

To search, simply enter a text to search for and press **Enter**.

Note that the search term supports advanced features known from web search engines, which means that the following list of characters carry special meaning: + - & & || ! () ^ [] “ ~ * ? : \ / . To avoid this special interpretation it is suggested to put quotes around the search expression when searching for data containing the special characters, or read the section 3.5.3 on advanced search expressions.

Quick search results

To show the results, the search pane is expanded as shown in figure 3.36).

If there are many hits, only the 50 first hits are immediately shown. At the bottom of the pane you can click **Next** (→) to see the next 50 hits (see figure 3.37).

If a search gives no hits, you will be asked if you wish to search for matches that start with your search term. If you accept this, an asterisk (*) will be appended to the search term.

Pressing the Alt key while you click a search result will high-light the search hit in its folder in the **Navigation Area**.

In the preferences (see Chapter 4), you can specify the number of hits to be shown.

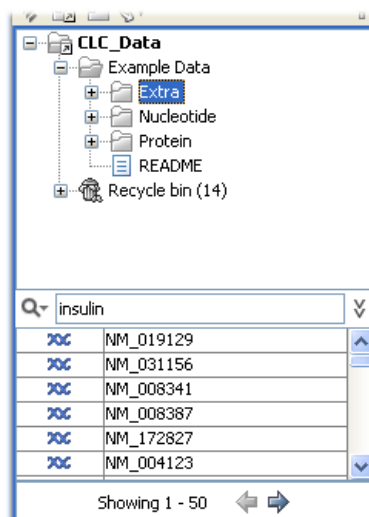

Figure 3.36: Search results.

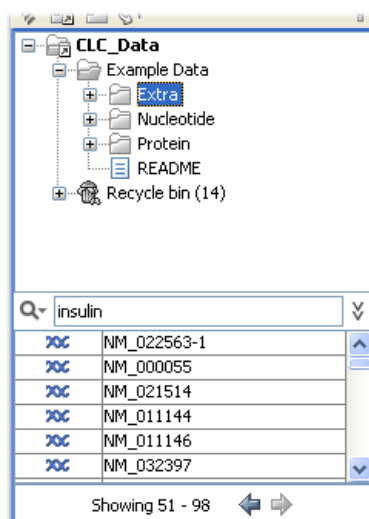

Figure 3.37: Page two of the search results.

Special search expressions

When you write a search term in the search field, you can get help to write a more advanced search expression by pressing **Shift+F1**. This will reveal a list of guides as shown in figure 3.38.

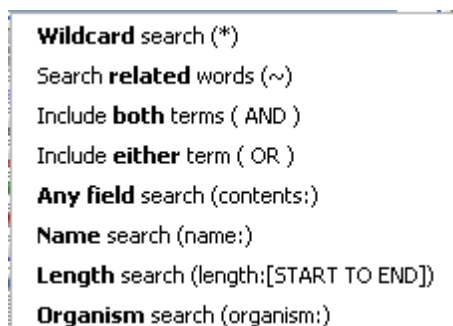

Figure 3.38: Guides to help create advanced search expressions.

You can select any of the guides (using mouse or keyboard arrows), and start typing. If you e.g.

wish to search for sequences named BRCA1, select "Name search (name:)", and type "BRCA1". Your search expression will now look like this: "name:BRCA1".

The guides available are these:

- **Wildcard search (*)**. Appending an asterisk * to the search term will find matches starting with the term. E.g. searching for "brca*" will find both *brca1* and *brca2*.
- **Search related words (~)**. If you don't know the exact spelling of a word, you can append a tilde to the search term. E.g. "brac1~" will find sequences with a *brca1* gene.
- **Include both terms (AND)**. If you write two search terms, you can define if your results have to match both search terms by combining them with AND. E.g. search for "brca1 AND human" will find sequences where *both* terms are present.
- **Include either term (OR)**. If you write two search terms, you can define that your results have to match either of the search terms by combining them with OR. E.g. search for "brca1 OR brca2" will find sequences where *either* of the terms is present.
- **Do not include term (NOT)** If you write a term after not, then elements with these terms will not be returned.
- **Name search (name:)**. Search only the name of element.
- **Organism search (organism:)**. For sequences, you can specify the organism to search for. This will look in the "Latin name" field which is seen in the **Sequence Info** view (see section 10.4).
- **Length search (length:[START TO END])**. Search for sequences of a specific length. E.g. search for sequences between 1000 and 2000 residues: "length:1000 TO 2000".

Note! If you have added attributes (see section 3.4), these will also appear on the list when pressing **Shift+F1**.

If you do not use this special syntax, you will automatically search for both name, description, organism, etc., and search terms will be combined as if you had put OR between them.

Search for data locations

The search function can also be used to search for a specific URL. This can be useful if you work on a server and wish to share a data location with another user. A simple example is shown in figure 3.40. Right click on the object name in the **Navigation Area** (in this case ATP8a1 genomic sequence) and select "Copy". When you use the paste function in a destination outside the Workbench (e.g. in a text editor or in an email), the data location will become visible. The URL can now be used in the search field in the Workbench to locate the object.

Quick search history

You can access the 10 most recent searches by clicking the icon (Q-) next to the search field (see figure 3.41).

Clicking one of the recent searches will conduct the search again.

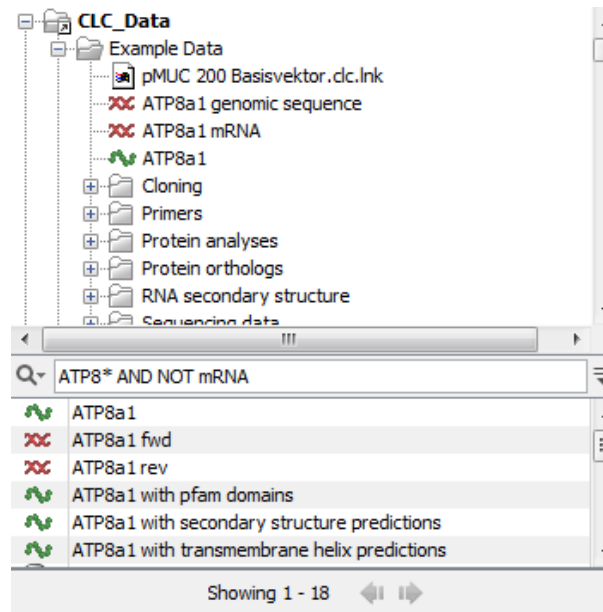

Figure 3.39: An example of searching for elements with the name, description and organism information that includes "ATP8" but do not include the term "mRNA".

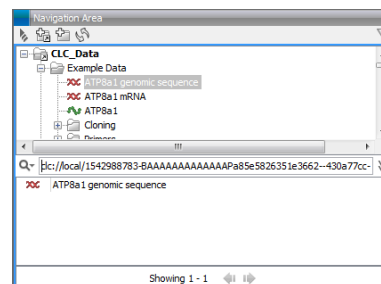

Figure 3.40: The search field can also be used to search for data locations.

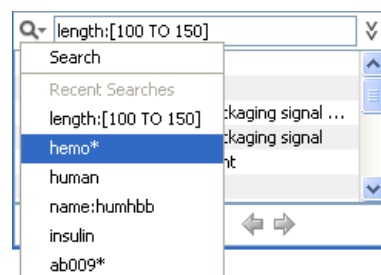

Figure 3.41: Recent searches.

3.5.3 Advanced search

As a supplement to the **Quick search** described in the previous section you can use the more advanced search:

Edit | Local Search (📄)

or **Ctrl + Shift + F** (⌘ + Shift + F on Mac)

This will open the search view as shown in figure 3.42

The first thing you can choose is which location should be searched. All the active locations are

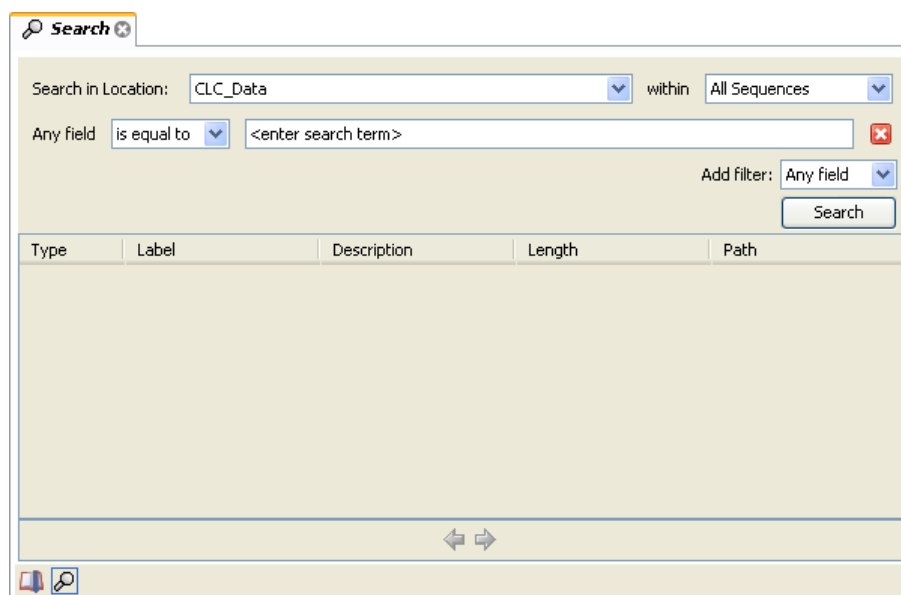

Figure 3.42: *Advanced search.*

shown in this list. You can also choose to search all locations. Read more about locations in section [3.1.1](#).

Furthermore, you can specify what kind of elements should be searched:

- All sequences
- Nucleotide sequences
- Protein sequences
- All data

When searching for sequences, you will also get alignments, sequence lists etc as result, if they contain a sequence which match the search criteria.

Below are the search criteria. First, select a relevant search filter in the **Add filter:** list. For sequences you can search for

- Name
- Length
- Organism

See section [3.5.2](#) for more information on individual search terms.

For all other data, you can only search for name.

If you use **Any field**, it will search all of the above plus the following:

- Description
- Keywords

- Common name
- Taxonomy name

To see this information for a sequence, switch to the **Element Info** (📄) view (see section 10.4).

For each search line, you can choose if you want the exact term by selecting "is equal to" or if you only enter the start of the term you wish to find (select "begins with").

An example is shown in figure 3.43.

The screenshot shows a search interface with the following parameters:

- Search in Location: CLC_Data
- within: Nucleotide Sequence
- Organism: is equal to homo sapiens
- Length: is less than 10000
- Add filter: Length

The search results are displayed in a table:

Type	Label	Description	Length	Path
🔗	BC030969	Homo sapiens breast cancer 1, early onset, mRNA (c...	2090	{CLC_Data}
🔗	BC072418	Homo sapiens breast cancer 1, early onset, mRNA (c...	3273	{CLC_Data}
🔗	BC106745	Homo sapiens breast cancer 1, early onset, mRNA (c...	1468	{CLC_Data}
🔗	BC106746	Homo sapiens breast cancer 1, early onset, mRNA (c...	779	{CLC_Data}
🔗	BC115037	Homo sapiens breast cancer 1, early onset, mRNA (c...	5854	{CLC_Data}
🔗	BC062429	Homo sapiens breast cancer 1, early onset, mRNA (c...	1322	{CLC_Data}

Showing 1 - 6

Figure 3.43: Searching for human sequences shorter than 10,000 nucleotides.

This example will find human nucleotide sequences (organism is *Homo sapiens*), and it will only find sequences shorter than 10,000 nucleotides.

Note that a search can be saved (📌) for later use. You do not save the search results - only the search parameters. This means that you can easily conduct the same search later on when your data has changed.

3.5.4 Search index

This section has a technical focus and is not relevant if your searches are working well.

However, if you experience problems with your search results: if you do not get the hits you expect, it might be because of an index error.

The *CLC Genomics Workbench* automatically maintains an index of all data in all locations in the **Navigation Area**. If this index becomes out of sync with the data, you will experience problems with strange results. In this case, you can rebuild the index:

Right-click the relevant location | Location | Rebuild Index

This will take a while depending on the size of your data. At any time, the process can be stopped in the process area, see section 2.3.1.

Chapter 4

User preferences and settings

Contents

4.1	General preferences	105
4.2	View preferences	106
4.2.1	Import and export Side Panel settings	108
4.3	Data preferences	109
4.4	Advanced preferences	109
4.5	Export/import of preferences	110
4.5.1	The different options for export and import	111
4.6	View settings for the Side Panel	111
4.6.1	Saving, removing and applying saved settings	111

The first three sections in this chapter deal with the general preferences that can be set for *CLC Genomics Workbench* using the **Preferences** dialog. The next section explains how the settings in the **Side Panel** can be saved and applied to other views. Finally, you can learn how to import and export the preferences.

The **Preferences** dialog offers opportunities for changing the default settings for different features of the program.

The **Preferences** dialog is opened in one of the following ways and can be seen in figure 4.1:

Edit | Preferences (⚙️)

or **Ctrl + K** (⌘ + ; on Mac)

4.1 General preferences

The **General** preferences include:

- **Undo Limit.** As default the undo limit is set to 500. By writing a higher number in this field, more actions can be undone. Undo applies to all changes made on molecules, sequences, alignments or trees. See section 2.1.6 for more on this topic.

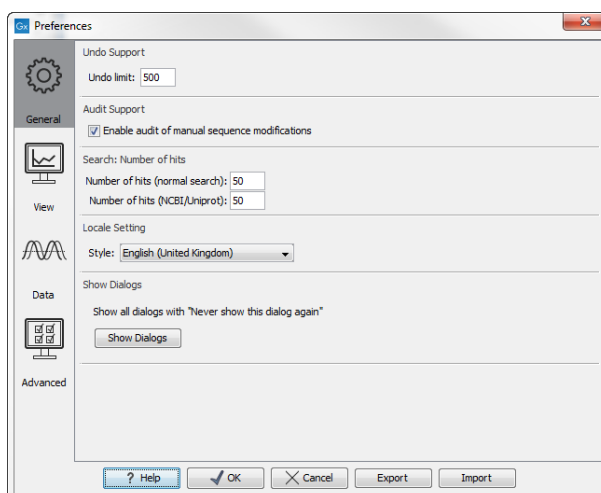

Figure 4.1: Preferences include General preferences, View preferences, Data preferences, and Advanced settings.

- Audit Support.** If this option is checked, all manual editing of sequences will be marked with an annotation on the sequence (see figure 4.2). Placing the mouse on the annotation will reveal additional details about the change made to the sequence (see figure 4.3). Note that no matter whether **Audit Support** is checked or not, all changes are also recorded in the **History** (🕒) (see section 2.1.2).
- Number of hits.** The number of hits shown in *CLC Genomics Workbench*, when e.g. searching NCBI. (The sequences shown in the program are not downloaded, until they are opened or dragged/saved into the Navigation Area).
- Locale Setting.** Specify which country you are located in. This determines how punctuation is used in numbers all over the program.
- Show Dialogs.** A lot of information dialogs have a checkbox: "Never show this dialog again". When you see a dialog and check this box in the dialog, the dialog will not be shown again. If you regret and wish to have the dialog displayed again, click the button in the General Preferences: **Show Dialogs**. Then all the dialogs will be shown again.

Deleted selection Editing of sequence selection
 220 240 260
 :GAGATGCCATGCCGAGGACAGTCCGGAGATCCCGCTCGCGCGCGGA

Figure 4.2: Annotations added when the sequence is edited.

Deleted selection Editing of sequence selection
 220 260
 :GAGATGCC GATCCCGCTCGCGCGCGGAAGGTTAT
 Audit (Deleted selection):
 /date=Fri Dec 17 19:46:27 CET 2010
 /user=smoensted
 /note=Region: 225..228
 /note=Sequence deleted: CCGA

Figure 4.3: Details of the editing.

4.2 View preferences

There are six groups of default **View** settings:

1. **Toolbar** lets you choose the size of the toolbar icons, and whether to display names below the icons (figure 4.4).

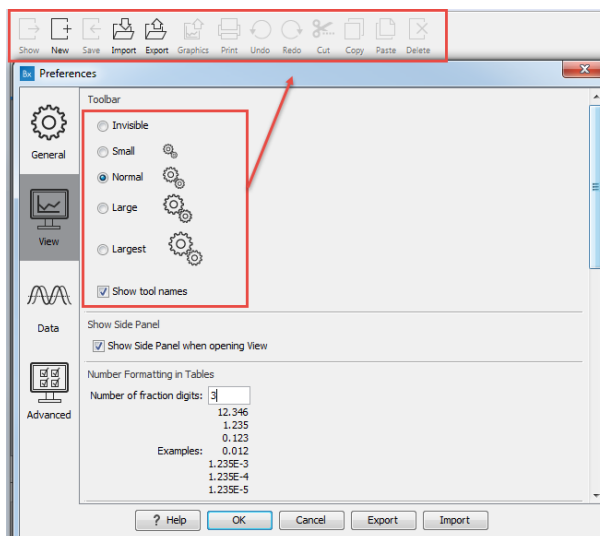

Figure 4.4: Number formatting of tables.

2. **Show Side Panel** allows you to choose whether to display the side panel when opening a new view. Note that for any open view, the side panel can be collapsed by clicking on the small triangle at the top left side of the settings area or by using the key combination Ctrl + U (⌘ + U on Mac).
3. **Number formatting in tables** specifies how the numbers should be formatted in tables (see figure 4.5). The examples below the text field are updated when you change the value so that you can see the effect. After you have changed the preference, you have to re-open your tables to see the effect.

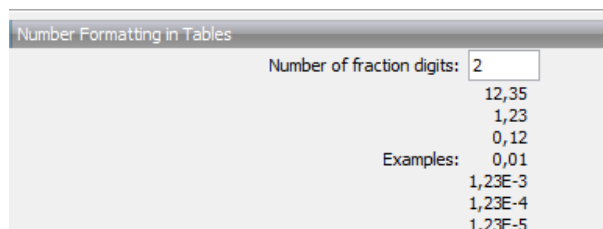

Figure 4.5: Number formatting of tables.

4. **Sequence Representation** allows you to change the way the elements appear in the Navigation Area. The following text can be used to describe the element:

- Name (this is the default information to be shown).
- Accession (sequences downloaded from databases like GenBank have an accession number).
- Latin name.
- Latin name (accession).
- Common name.
- Common name (accession).

5. **User Defined View Settings** gives you an overview of the different Side Panel settings that are saved for each view. See section 4.6 to learn more about how to create and save style sheets. If there are other settings beside CLC Standard Settings, you can use this overview to choose which of the settings should be used per default when you open a view (see an example in figure 4.6).

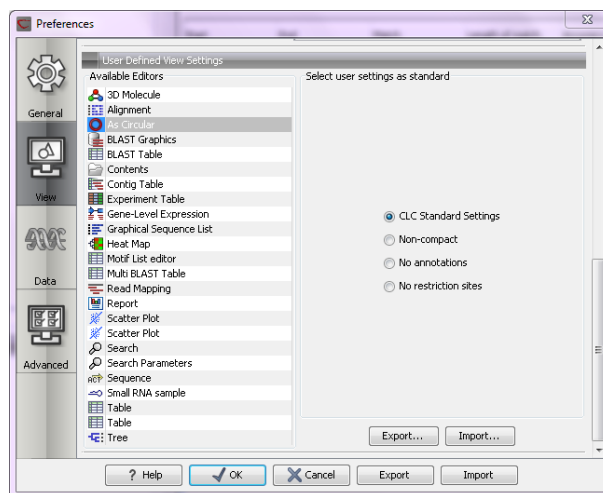

Figure 4.6: Selecting the default view setting. In this example, the CLC Standard Settings is chosen as default.

6. **Molecule Project 3D Editor** gives you the option to turn off the modern OpenGL rendering for **Molecule Projects** (see section 12.2.2).

4.2.1 Import and export Side Panel settings

If you have created a special set of settings in the **Side Panel** that you wish to share with other CLC users, you can export the settings in a file. The other user can then import the settings.

To export the **Side Panel** settings, first select the views that you wish to export settings for. Use Ctrl+click (⌘ + click on Mac) or Shift+click to select multiple views. Next click the **Export...** button. Note that there is also another export button at the very bottom of the dialog, but this will export the other settings of the **Preferences** dialog (see section 4.5).

A dialog will be shown (see figure 4.7) that allows you to select which of the settings you wish to export.

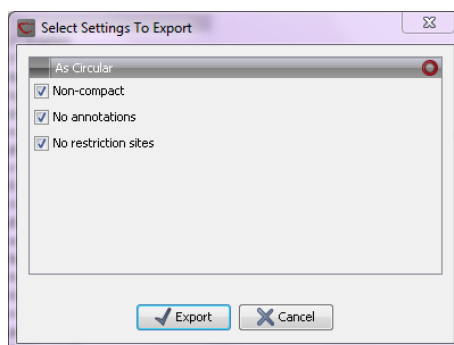

Figure 4.7: Exporting all settings for circular views.

When multiple views are selected for export, all the view settings for the views will be shown in the dialog. Click **Export** and you will now be able to define a save folder and name for the exported file. The settings are saved in a file with a .vsf extension (View Settings File).

To import a **Side Panel** settings file, make sure you are at the bottom of the **View** panel of the **Preferences dialog**, and click the **Import...** button. Note that there is also another import button at the very bottom of the dialog, but this will import the other settings of the **Preferences** dialog (see section 4.5).

The dialog asks if you wish to overwrite existing **Side Panel** settings, or if you wish to merge the imported settings into the existing ones (see figure 4.8).

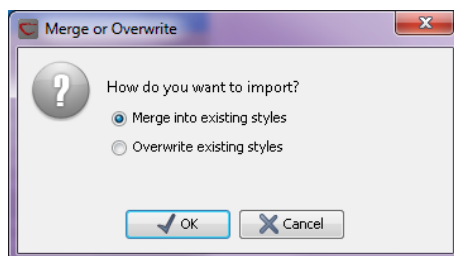

Figure 4.8: When you import settings, you are asked if you wish to overwrite existing settings or if you wish to merge the new settings into the old ones.

Note! If you choose to overwrite the existing settings, you will lose all the **Side Panel** settings that you have previously saved.

To avoid confusion of the different import and export options, here is an overview:

- Import and export of **bioinformatics data** such as sequences, alignments etc. (described in section 6.1).
- **Graphics** export of the views which creates image files in various formats (described in section 6.6).
- Import and export of **Side Panel Settings** as described above.
- Import and export of all the **Preferences** except the Side Panel settings. This is described in the previous section.

4.3 Data preferences

The data preferences contain preferences related to interpretation of data, e.g. linker sequences:

- Linkers for importing 454 data (see section 6.3.1).
- Predefined primer additions for Gateway cloning (see section 18.2.1).
- Adapter sequences for trimming (see section 22.1.2).

4.4 Advanced preferences

Proxy Settings The Advanced settings include the possibility to set up a proxy server. This is described in section 1.9.

Default data location The default location is used when you import a file without selecting a folder or element in the Navigation Area first. It is set to the folder called CLC_Data in the Navigation Area, but can be changed to another data location using a drop down list of data locations already added (see section 3.1.1). Note that the default location cannot be removed, but only changed to another location.

NCBI BLAST The standard URL for the BLAST server at NCBI is: <https://blast.ncbi.nlm.nih.gov/Blast.cgi>, but it is possible to specify an alternate server URL to use for BLAST searches. Be careful to specify a valid URL, otherwise BLAST will not work.

Read Mapper It is possible to change the size (in MB) of the Read Mapper reference cache.

SRA Download The following options are available:

- **Use Aspera when available** Per default, Aspera is automatically used if installed. This option makes it possible to disable Aspera.
- **Limit Aspera download speeds to [] Mb/s (Mac and Linux only)** Using Aspera may take up a lot of network resources. Use this option to specify a maximum download speed (in megabit per second). Note that this option is only available on Mac and Linux. For Windows users, it is possible to limit the maximum download speed by modifying the `aspera.conf` file,

which can be found in `C:\Program Files (x86)\Aspera\Aspera Connect\etc`. See <http://download.asperasoft.com/download/docs/csrv/3.3.4/linux/html/index.html> and <http://download.asperasoft.com/download/docs/csrv/3.3.4/linux/html/fasp/setting-global-bandwidth.html> for more details.

CLC Server Login It is possible to Save the login username and password, initiate automatic server login when opening the workbench, and bypass a proxy server.

4.5 Export/import of preferences

The user preferences of the *CLC Genomics Workbench* can be exported to other users of the program, allowing other users to display data with the same preferences as yours. You can also use the export/import preferences function to backup your preferences.

To export preferences, open the **Preferences** dialog (Ctrl + K (⌘ + ; on Mac)) and do the following:

Export | Select the relevant preferences | Export | Choose location for the exported file | Enter name of file | Save

Note! The format of exported preferences is `.cpf`. This notation must be submitted to the name of the exported file in order for the exported file to work.

Before exporting, you are asked about which of the different settings you want to include in the exported file. One of the items in the list is "User Defined View Settings". If you export this, only the information about which of the settings is the default setting for each view is exported. If you wish to export the **Side Panel Settings** themselves, see section 4.2.1.

The process of importing preferences is similar to exporting:

Press Ctrl + K (⌘ + ; on Mac) to open Preferences | Import | Browse to and select the .cpf file | Import and apply preferences

4.5.1 The different options for export and import

To avoid confusion of the different import and export options, you can find an overview here:

- Import and export of **bioinformatics data** such as molecules, sequences, alignments etc. (described in section 6.1).
- **Graphics** export of the views that create image files in various formats (described in section 6.6).
- Import and export of **Side Panel Settings** as described in the next section.
- Import and export of all the **Preferences** except the Side Panel settings. This is described above.

4.6 View settings for the Side Panel

The **Side Panel** is shown to the right of all views that are opened in *CLC Genomics Workbench* and is described in further detail in section 2.1.9.

When you have adjusted a view of a sequence, your settings in the **Side Panel** can be saved. When you open other sequences, which you want to display in a similar way, the saved settings can be applied. The options for saving and applying are available at the bottom of the **Side Panel** (see figure 4.9).

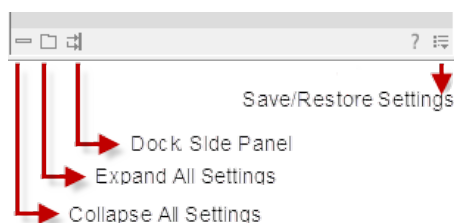

Figure 4.9: At the bottom of the Side Panel you save the view settings

4.6.1 Saving, removing and applying saved settings

To save and apply the saved settings, click (☰) seen in figure 4.9. This opens a menu where the following options are available (figure 4.10):

- **Save ... Settings.** (⚙) The settings can be saved in two different ways. When you select either way of saving settings a dialog will open (see figure 4.11) where you can enter a name for your settings.
 - **For ... View in General** (⚙) Will save the currently used settings with all elements of the same type as the one used for adjusting the settings. E.g. if you have selected to

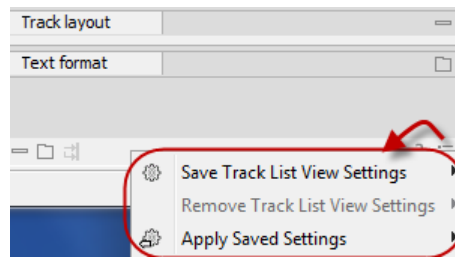

Figure 4.10: When you have adjusted the side panel settings and would like to save these, this can be done with the "Save ... Settings" function, where "..." is the element you are working on - e.g. "Track List View", "Sequence View", "Table View", "Alignment View" etc. Saved settings can be deleted again with "Remove ... Settings" and can be applied to other elements with "Apply Saved Settings".

save settings "For Track View in General" the settings will be applied each time you open an element of the same type, which in this case means each time one of the saved tracks are opened from the **Navigation Area**. These "general" settings are user specific and will not be saved with or exported with the element.

- **On This Only** (📁) Settings can be saved with the specific element that you are working on in the View area and will not affect any other elements (neither in the View Area or in the **Navigation Area**). E.g. for a track you would get the option to save settings "On This Track Only". The settings are saved with only this element (and will be exported with the element if you later select to export the element to another destination).

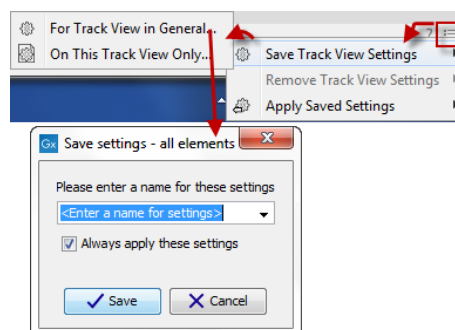

Figure 4.11: The save settings dialog. Two options exist for saving settings. Click on the relevant option to open the dialog shown at the bottom of the figure.

- **Remove ... Settings.** (🗑️) Gives you the option to remove settings specifically for the element that you are working on in the View Area, or on all elements of the same type. When you have selected the relevant option, the dialog shown in figure 4.12 opens and allows you to select which of the saved settings to remove.
 - **From ... View in General** (🗑️) Will remove the currently used settings on all elements of the same type as the one used for adjusting the settings. E.g. if you have selected to remove settings from all alignments using "From Alignment View in General", all alignments in your **Navigation Area** will be opened with the standard settings instead.
 - **From This ... Only** (🗑️) When you select this option, the selected settings will only be removed from the particular element that you are working on in the View area and will not affect any other elements (neither in the View Area or in the **Navigation Area**). The settings for this particular element will be replaced with the CLC standard settings (🗑️).

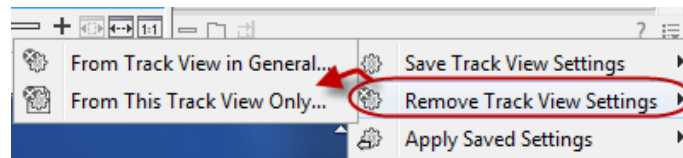

Figure 4.12: The remove settings dialog for a track.

- **Apply Saved Settings.** (🔧) This is a submenu containing the settings that you have previously saved (figure 4.13). By clicking one of the settings, they will be applied to the current view. You will also see a number of pre-defined view settings in this submenu. They are meant to be examples of how to use the **Side Panel** and provide quick ways of adjusting the view to common usages. At the bottom of the list of settings you will see **CLC Standard Settings** which represent the way the program was set up, when you first launched it. (🔧)

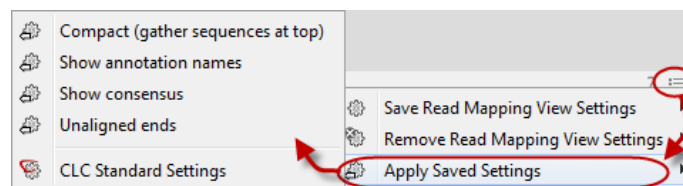

Figure 4.13: Applying saved settings.

The settings are specific to the type of view. Hence, when you save settings of a circular view, they will not be available if you open the sequence in a linear view.

If you wish to export the settings that you have saved, this can be done in the **Preferences** dialog under the **View** tab (see section 4.2.1).

Chapter 5

Printing

Contents

5.1	Selecting which part of the view to print	115
5.2	Page setup	116
5.3	Print preview	117

CLC Genomics Workbench offers different choices of printing the result of your work.

This chapter deals with printing directly from *CLC Genomics Workbench*. Another option for using the graphical output of your work, is to export graphics (see chapter 6.6) in a graphic format, and then import it into a document or a presentation.

All the kinds of data that you can view in the **View Area** can be printed. The *CLC Genomics Workbench* uses a WYSIWYG principle: What You See Is What You Get. This means that you should use the options in the Side Panel to change how your data, e.g. a sequence, looks on the screen. When you print it, it will look exactly the same way on print as on the screen.

For some of the views, the layout will be slightly changed in order to be printer-friendly.

It is not possible to print elements directly from the **Navigation Area**. They must first be opened in a view in order to be printed. To print the contents of a view:

select relevant view | Print (🖨️) in the toolbar

This will show a print dialog (see figure 5.1).

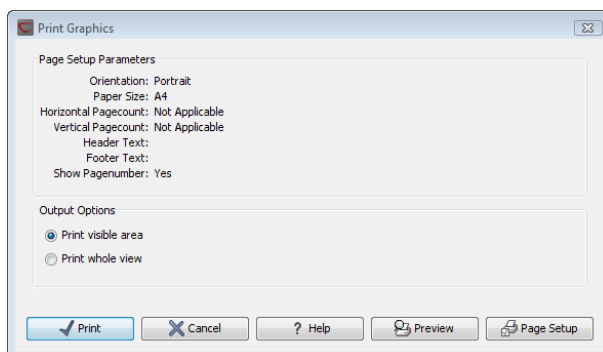

Figure 5.1: The Print dialog.

In this dialog, you can:

- Select which part of the view you want to print.
- Adjust **Page Setup**.
- See a print **Preview** window.

These three options are described in the three following sections.

5.1 Selecting which part of the view to print

In the print dialog you can choose to:

- **Print visible area**, or
- **Print whole view**

These options are available for all views that can be zoomed in and out. In figure 5.2 is a view of a circular sequence which is zoomed in so that you can only see a part of it.

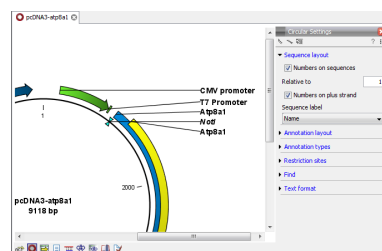

Figure 5.2: A circular sequence as it looks on the screen.

When selecting **Print visible area**, your print will reflect the part of the sequence that is *visible* in the view. The result from printing the view from figure 5.2 and choosing **Print visible area** can be seen in figure 5.3.

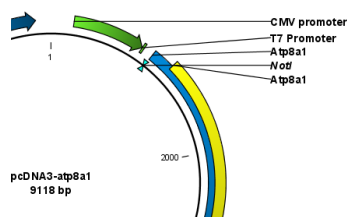

Figure 5.3: A print of the sequence selecting *Print visible area*.

On the other hand, if you select **Print whole view**, you will get a result that looks like figure 5.4. This means that you also print the part of the sequence which is not visible when you have zoomed in.

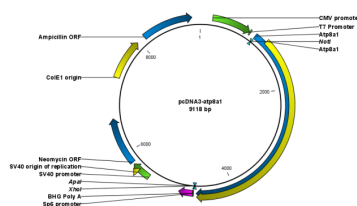

Figure 5.4: A print of the sequence selecting *Print whole view*. The whole sequence is shown, even though the view is zoomed in on a part of the sequence.

5.2 Page setup

No matter whether you have chosen to print the visible area or the whole view, you can adjust page setup of the print. An example of this can be seen in figure 5.5

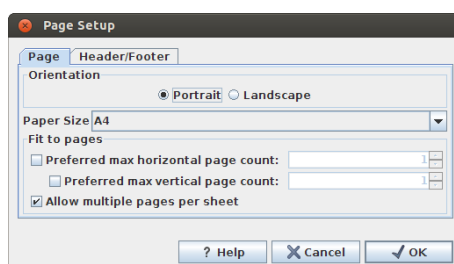

Figure 5.5: *Page Setup*.

In this dialog you can adjust both the setup of the pages and specify a header and a footer by clicking the tab at the top of the dialog.

You can modify the layout of the page using the following options:

- **Orientation.**
 - **Portrait.** Will print with the paper oriented vertically.
 - **Landscape.** Will print with the paper oriented horizontally.
- **Paper size.** Adjust the size to match the paper in your printer.
- **Fit to pages.** Can be used to control how the graphics should be split across pages (see figure 5.6 for an example).
 - **Horizontal pages.** If you set the value to e.g. 2, the printed content will be broken up horizontally and split across 2 pages. This is useful for sequences that are not wrapped
 - **Vertical pages.** If you set the value to e.g. 2, the printed content will be broken up vertically and split across 2 pages.

Note! It is a good idea to consider adjusting view settings (e.g. **Wrap** for sequences), in the **Side Panel** before printing. As explained in the beginning of this chapter, the printed material will look like the view on the screen, and therefore these settings should also be considered when adjusting **Page Setup**.



Figure 5.6: An example where *Fit to pages horizontally* is set to 2, and *Fit to pages vertically* is set to 3.

Header and footer Click the **Header/Footer** tab to edit the header and footer text. By clicking in the text field for either **Custom header text** or **Custom footer text** you can access the auto formats for header/footer text in **Insert a caret position**. Click either **Date**, **View name**, or **User name** to include the auto format in the header/footer text.

Click **OK** when you have adjusted the **Page Setup**. The settings are saved so that you do not have to adjust them again next time you print. You can also change the **Page Setup** from the **File** menu.

5.3 Print preview

The preview is shown in figure 5.7.

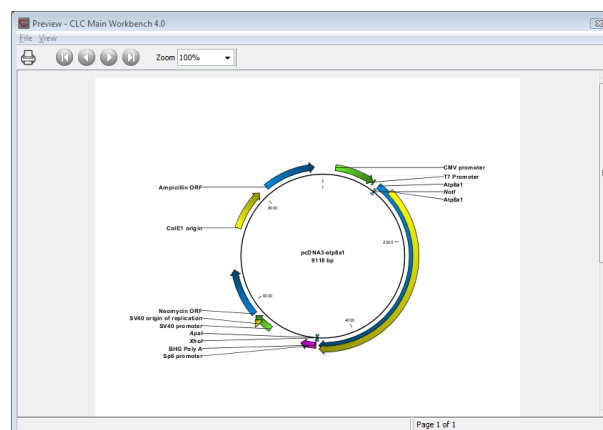



Figure 5.7: *Print preview.*

The **Print preview** window lets you see the layout of the pages that are printed. Use the arrows in the toolbar to navigate between the pages. Click Print () to show the print dialog, which lets you choose e.g. which pages to print.

The **Print preview** window is for preview only - the layout of the pages must be adjusted in the **Page setup**.

Chapter 6

Import/export of data and graphics

Contents

6.1	Standard import	119
6.1.1	Import using the import dialog	119
6.1.2	Import using drag and drop	120
6.1.3	Import using copy/paste of text	120
6.1.4	External files	121
6.2	Import tracks	121
6.2.1	GFF3 format	124
6.3	Import high-throughput sequencing data	128
6.3.1	Roche 454	128
6.3.2	Illumina	130
6.3.3	PacBio	136
6.3.4	SOLiD	137
6.3.5	Fasta read files	140
6.3.6	Sanger sequencing data	142
6.3.7	Ion Torrent	143
6.3.8	Complete Genomics	144
6.3.9	General notes on handling paired data	145
6.3.10	SAM and BAM mapping files	146
6.4	Import RNA spike-in controls	149
6.5	Data export	150
6.5.1	Export of folders and multiple elements in CLC format	155
6.5.2	Export of dependent elements	155
6.5.3	Export history	156
6.5.4	The CLC format	157
6.5.5	Backing up data from the CLC Workbench	157
6.5.6	Export of tables	158
6.6	Export graphics to files	159
6.6.1	Which part of the view to export	160
6.6.2	Save location and file formats	161
6.6.3	Graphics export parameters	162

6.6.4	Exporting protein reports	163
6.7	Export graph data points to a file	163
6.8	Copy/paste view output	165

CLC Genomics Workbench handles a large number of different data formats. In order to work with data in the Workbench, it has to be imported (📁). Data types that are not recognized by the Workbench are imported as "external files" which means that when you open these, they will open in the default application for that file type on your computer (e.g. Word documents will open in Word).

This chapter first deals with importing and exporting data in bioinformatic data formats and as external files. Next comes an explanation of how to export graph data points to a file, and how to export graphics.

For **import of NGS data**, please see section [6.3](#).

6.1 Standard import

CLC Genomics Workbench has support for a wide range of bioinformatic data such as molecules, sequences, alignments etc. See a full list of the data formats in section [1.1](#).

These data can be imported through the Import dialog, using drag/drop or copy/paste as explained below.

For **import of NGS data**, please see section [6.3](#) For import of tracks, please see section [6.2](#).

6.1.1 Import using the import dialog

To start the import using the import dialog:

click Import (📁) in the Toolbar | Standard Import

This will show a dialog similar to figure [6.1](#). You can change which kind of file types that should be shown by selecting a file format in the **Files of type** box.

Next, select one or more files or folders to import and click **Next**.

This allows you to select a place for saving the result files.

If you import one or more folders, the contents of the folder is automatically imported and placed in that folder in the **Navigation Area**. If the folder contains subfolders, the whole folder structure is imported.

In the import dialog (figure [6.1](#)), there are three import options:

Automatic import This will import the file and *CLC Genomics Workbench* will try to determine the format of the file. The format is determined based on the file extension (e.g. SwissProt files have .swp at the end of the file name) in combination with a detection of elements in the file that are specific to the individual file formats. If the file type is not recognized, it will be imported as an external file. In most cases, automatic import will yield a successful result, but if the import goes wrong, the next option can be helpful:

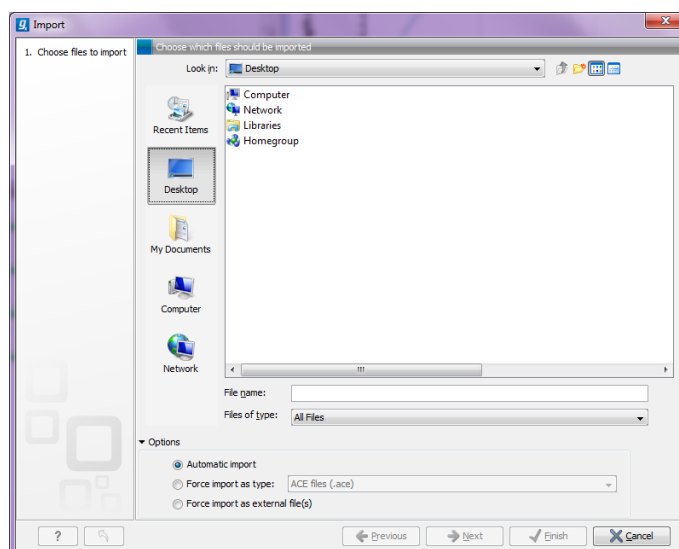

Figure 6.1: The import dialog.

Force import as type This option should be used if *CLC Genomics Workbench* cannot successfully determine the file format. By forcing the import as a specific type, the automatic determination of the file format is bypassed, and the file is imported as the type specified.

Force import as external file This option should be used if a file is imported as a bioinformatics file when it should just have been external file. It could be an ordinary text file which is imported as a sequence.

6.1.2 Import using drag and drop

It is also possible to drag a file from e.g. the desktop into the **Navigation Area** of *CLC Genomics Workbench*. This is equivalent to importing the file using the **Automatic import** option described above. If the file type is not recognized, it will be imported as an external file.

6.1.3 Import using copy/paste of text

If you have e.g. a text file or a browser displaying a sequence in one of the formats that can be imported by *CLC Genomics Workbench*, there is a very easy way to get this sequence into the **Navigation Area**:

**Copy the text from the text file or browser | Select a folder in the Navigation Area
| Paste (📄)**

This will create a new sequence based on the text copied. This operation is equivalent to saving the text in a text file and importing it into the *CLC Genomics Workbench*.

If the sequence is not formatted, i.e. if you just have a text like this: "ATGACGAATAGGAGTTC-TAGCTA" you can also paste this into the **Navigation Area**.

Note! Make sure you copy all the relevant text - otherwise *CLC Genomics Workbench* might not be able to interpret the text.

6.1.4 External files

In order to help you organize your research projects, *CLC Genomics Workbench* lets you import all kinds of files. E.g. if you have Word, Excel or pdf-files related to your project, you can import them into the **Navigation Area** of *CLC Genomics Workbench*. Importing an external file creates a copy of the file which is stored at the location you have chosen for import. The file can now be opened by double-clicking the file in the **Navigation Area**. The file is opened using the default application for this file type (e.g. Microsoft Word for .doc-files and Adobe Reader for .pdf).

External files are imported and exported in the same way as bioinformatics files (see section 6.1). Bioinformatics files not recognized by *CLC Genomics Workbench* are also treated as external files.

There is a special tool for importing data from Vector NTI. This tool is a plugin which can be downloaded and installed in the *CLC Genomics Workbench* using the plugin manager (see section 1.6).

6.2 Import tracks

Tracks (see chapter 23) are imported in a special way, because extra information is needed in order to interpret the files correctly.

Tracks are imported using: **click Import (📁) in the Toolbar | Tracks**

This will open a dialog as shown in figure 6.2. At the top, you select the file type to import.

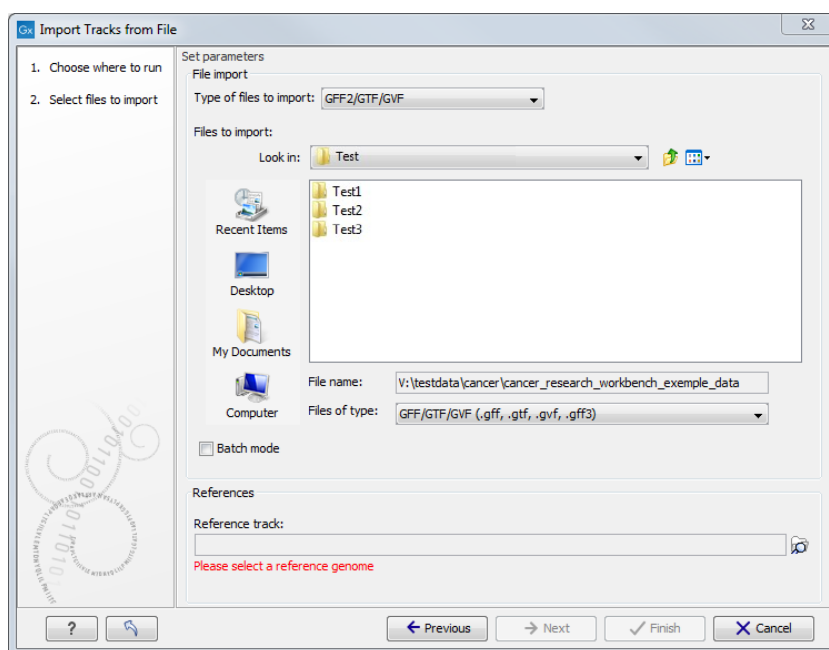

Figure 6.2: Select files to import.

Below, select the files to import. If import is performed with the batch option selected, then each file is processed independently and separate tracks are produced for each file. If the batch option is not selected, then variants for all files will be added to the same track (or tracks in the case VCF files including genotype information). The formats currently accepted are:

FASTA This is the standard fasta importer that will produce a sequence track rather than a standard fasta sequence. Please note that this could also be achieved by importing using

Standard Import (see section 6) and subsequently converting the sequence or sequence list to a track (see section 23.4).

GFF2/GTF/GVF A GFF2/GTF file does not contain any sequence information, it only contains a list of various types of annotations. A GVF file is similar to a GFF file but uses Sequence Ontology to describe genome variation data. For these formats, the importer adds the annotation in each of the lines in the file to the chosen sequence, at the position or region in which the file specifies that it should go, and with the annotation type, name, description etc. as given in the file. However, special treatment is given to annotations of the types CDS, exon, mRNA, transcript and gene. For these, the following applies:

- A gene annotation is generated for each `gene_id`. The region annotated extends from the leftmost to the rightmost positions of all annotations that have the `gene_id` (gtf-style).
- CDS annotations that have the same `transcriptID` are joined to one CDS annotation (gtf-style). Similarly, CDS annotations that have the same parent are joined to one CDS annotation (gff-style).
- If there is more than one exon annotation with the same `transcriptID` these are joined to one mRNA annotation. If there is only one exon annotation with a particular `transcriptID`, and no CDS with this `transcriptID`, a transcript annotation is added instead of the exon annotation (gtf-style).
- Exon annotations that have the same parent mRNA are joined to one mRNA annotation. Similarly, exon annotations that have the same parent transcript, are joined to one transcript annotation (gff-style).

Note that genes and transcripts are linked by name only (not by position, ID etc).

For a comprehensive source of genomic annotation of genes and transcripts, we refer to the Ensembl web site at <http://www.ensembl.org/info/data/ftp/index.html>. On this page, you can download GTF files that can be used to annotate genomes for use in other analyses in the workbench. You can also read more about these formats at <http://www.sanger.ac.uk/resources/software/gff/spec.html>, <http://mblab.wustl.edu/GTF22.html> and <https://genomebiology.biomedcentral.com/articles/10.1186/gb-2010-11-8-r88>.

GFF3 A GFF3 file contains a list of various types of annotations that can be linked together with "Parent" and "ID" tags. Learn more about how the workbench handles GFF3 format in section 6.2.1.

VCF This is the file format used for variants by the 1000 Genomes Project and it has become a standard format. Read how to access data at <http://www.1000genomes.org/data#DataAccess>. When importing a single VCF file, you will get a track for each sample contained in the VCF file. In cases where more than one sample is contained in a VCF file, you can choose to import the files together or individually by using the batch mode found in the lower left side of the wizard shown in figure 6.2. The difference between the two import modes is that the batch mode will import the samples individually in separate track files, whereas the non-batch mode will keep variants for one sample in one track, thus merging samples from the different input files (in cases where the same sample is contained in different input files). If you import more than one VCF file that each contain more than one sample, the non-batch mode will generate one track file for each unique sample. The batch

mode will generate a track file for each of the original VCF files with the entire content, as if importing each of the VCF files one by one. For example, VCF file 1 contains sample 1 and sample 2, and VCF file 2 contains sample 2 and sample 3. When VCF file 1 and VCF file 2 are imported in non-batch mode, you will get three individual track files; one for each of the three samples 1, 2, and 3. If VCF file 1 and VCF file 2 were instead imported using the batch function, the result of the import would be four track files: a track from sample 1 from file 1, a track from sample 2 from file 1, a track from sample 2 from file 2, and a track from sample 3 from file 2.

Complete Genomics master var file This is the file format used by Complete Genomics for all kinds of variant data and can be used to analyze and visualize the variant calls made by Complete Genomics. Please note that you can import evidence files with the read alignments into the *CLC Genomics Workbench* as well (refer to the Complete Genomics import section of the Workbench user manual).

BED Simple format for annotations. Read more at <http://genome.ucsc.edu/FAQ/FAQformat.html#format1>. This format is typically used for very simple annotations, for example target regions for sequence capture methods.

Wiggle The Wiggle format as defined by UCSC (<http://genome.ucsc.edu/goldenPath/help/wiggle.html>), is used to hold continuous data like conservation scores, GC content etc. When imported into the *CLC Genomics Workbench*, a graph track is created. An example of a popular Wiggle file is the conservation scores from UCSC which can be download for human from <http://hgdownload.cse.ucsc.edu/goldenPath/hg19/phastCons46way/>.

UCSC variant database table dump Table dumps of **variant** annotations from the UCSC can be imported using this option. Mainly files ending with `.txt.gz` on this list can be used: <http://hgdownload.cse.ucsc.edu/goldenPath/hg19/database/>. Please note that importer is for variant data and is not a general importer for all annotation types. This is mainly intended to allow you to import the popular *Common SNPs* variant set from UCSC. The file can be downloaded from the UCSC web site here: <http://hgdownload.cse.ucsc.edu/goldenPath/hg19/database/snp138Common.txt.gz>. Other sets of variant annotation can also be downloaded in this format using the UCSC Table Browser.

COSMIC variation database This lets you import the COSMIC database, which is a well-known publicly available primary database on somatic mutations in human cancer. The file can be downloaded from the UCSC web site here: <http://cancer.sanger.ac.uk/cancergenome/projects/cosmic/download>, and then go to 'Complete COSMIC data' and click on the file link. Users must first register to download the database. Import the file as a track. Through Import->Tracks we support certain COSMIC databases in tsv format that can be manually downloaded from the COSMIC ftp site:

- Complete COSMIC data (file: CosmicCompleteExport.tsv)
- Complete mutation data (file: CosmicMutantExport.tsv)
- All Mutation in census genes (file: CosmicMutantExportCensus.tsv)

Please see chapter [I.1.6](#) for more information on how different formats (e.g. VCF and GVF) are interpreted during import in CLC format. For all of the above, zip files are also supported. Please note that for human data, there is a difference between the UCSC genome build and

Ensembl/NCBI for the mitochondrial genome. This means that for the mitochondrial genome, data from UCSC should not be mixed with data from other sources (see <http://hgdownload.soe.ucsc.edu/goldenPath/hg19/bigZips/>). Most of the data above is annotation data and if the file includes information about allele variants (like VCF, Complete Genomics and GVF), it will be combined into one **variant** track that can be used for finding known variants in your experimental data. When the data cannot be recognized as variant data, one track is created for each annotation type. Genome / gene annotation tracks can be automatically imported from relevant databases as described here: http://resources.qiagenbioinformatics.com/manuals/clcgenomicsworkbench/current/index.php?manual=Selecting_data_types_download.html. For all types of files except fasta, you need to select a reference track as well. This is because most the annotation files do not contain enough information about chromosome names and lengths which are necessary to create the appropriate data structures.

6.2.1 GFF3 format

A GFF3 file contains a list of various types of annotations that can be linked together with "Parent" and "ID" tags.

Here are some example of a few common tags used by the format:

- **ID** IDs for each feature must be unique within the scope of the GFF file. In the case of discontinuous features (i.e., a single feature that exists over multiple genomic locations) the same ID may appear on multiple lines. All lines that share an ID collectively represent a single feature.
- **Parent** A parent ID can be used to group exons into transcripts, transcripts into genes, and so forth. A feature may have multiple parents. A parent ID can only be used to indicate a 'part of' relationship.
- **Name** The name that will be displayed as a label in the track view. Unlike IDs, there is no requirement that the Name be unique within the file.

Figure 6.3 exemplifies how tags are used to create annotations.

In the workbench, the GFF3 importer will create an output track for each feature type present in the file.

- **Gene-like types.** These are types described in the Sequence Ontology as being subtypes of genes, e.g. ncRNA_gene, plastid_gene, tRNA_gene. Gene-like types are gathered together into an aggregated track with a name of the form "myFileName (Gene)". We recommend that users use this file in RNA-Seq.
- **Transcript-like types.** These are types described in the Sequence Ontology as being subtypes of transcripts that are neither primary transcripts (i.e., they do not require further processing to become functional), nor fusion transcripts. Again, there are several dozen, such as mRNA, lnc_RNA, threonyl_RNA. Transcript-like types are gathered together into an aggregated track with a name of the form "myFileName (RNA)". We recommend that users use this file in RNA-Seq.

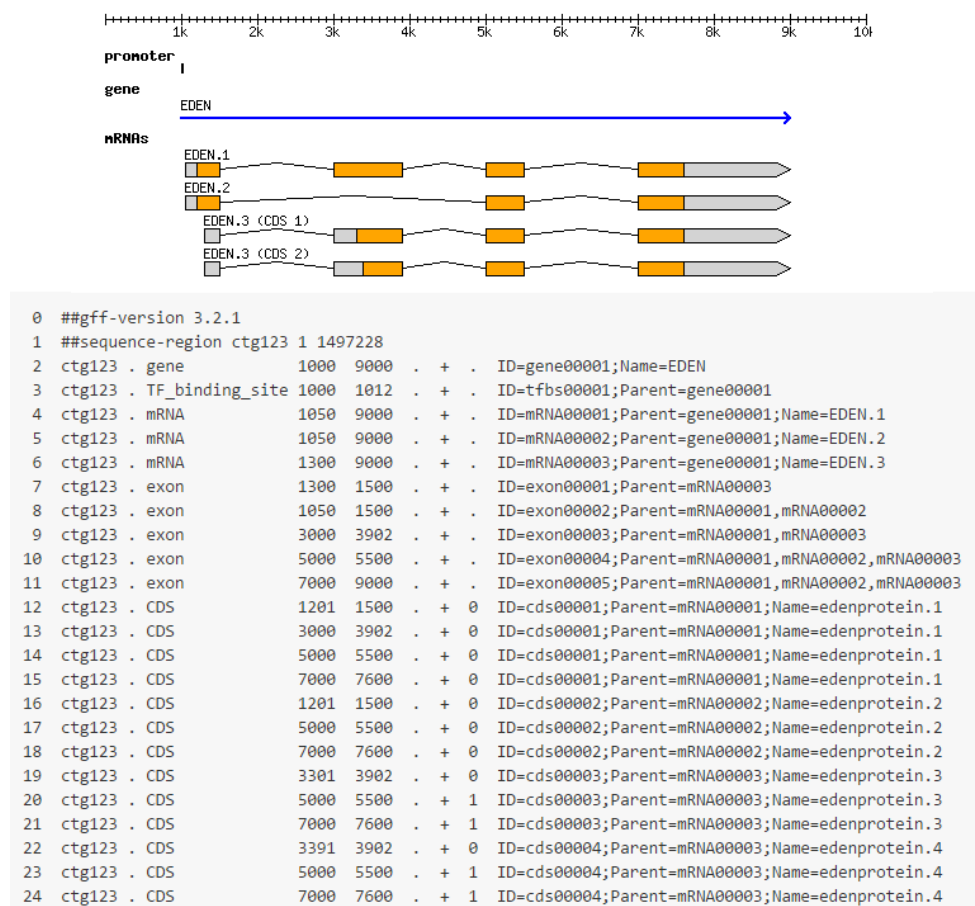

Figure 6.3: Example of a GFF3 file and the corresponding annotations from <https://github.com/The-Sequence-Ontology/Specifications/blob/master/gff3.md>.

- **Exons.** Where possible, exons are merged into their parent features. For example, the output of the lines shown in figure 6.4 will be a single mRNA feature with four exonic regions (from 1300 to 1500, 3000 to 3902, 5000 to 5500, and 7000 to 9000), and no exon features will be output on their own.

```

ctg123 . mRNA 1300 9000 . + . ID=mRNA00003;Parent=gene00001
ctg123 . exon 1300 1500 . + . Parent=mRNA00003
ctg123 . exon 3000 3902 . + . Parent=mRNA00003
ctg123 . exon 5000 5500 . + . Parent=mRNA00003
ctg123 . exon 7000 9000 . + . Parent=mRNA00003

```

Figure 6.4: Exons will be merged into their parent features when the parent is not a "gene-like" type.

However, in cases where the parent is of a "gene-like" type, exons are output as their own independent features in the exon track. Finding a lot of features in the exon track can suggest a problem with the file being imported. However, with large databases, this is more likely to be due to the database creators choosing to represent pseudogenes as exons with no transcript.

- **CDS** CDS regions with the same parent are joined together into a single spliced feature. If CDS features do not have a parent they are instead joined based on their ID, as for any other feature (described below)

- **Features with the same ID** Regardless of the feature type, features that have the same ID are merged into a single spliced feature. For example, the output of the following figure 6.5 will be a single cDNA_match feature with regions (1050..1500, 5000..5500, 7000..9000).

```
ctg123 . cDNA_match 1050 1500 5.8e-42 + . ID=match00001;Target=cdna0123 12 462
ctg123 . cDNA_match 5000 5500 8.1e-43 + . ID=match00001;Target=cdna0123 463 963
ctg123 . cDNA_match 7000 9000 1.4e-40 + . ID=match00001;Target=cdna0123 964 2964
```

Figure 6.5: Features that have the same ID are merged into a single spliced feature.

Naming of features

When one of the following qualifiers is present, it will be used for naming in the prioritized order:

1. the "Name" of the feature
2. the "Name" of the first named parent of the feature
3. the "ID" of the feature
4. the "ID" of the first parent
5. the type of the feature

Several examples of naming strategies are depicted in figure 6.6.

1) The mRNA from the following will be called "EDEN-001"

```
ctg123 . gene      1000 9000 . + . ID=gene00001;Name=EDEN
ctg123 . mRNA     1300 9000 . + . ID=mRNA00003;Parent=gene00001,Name=EDEN-001
```

2) The mRNA from the following will be called "EDEN"

```
ctg123 . gene      1000 9000 . + . ID=gene00001;Name=EDEN
ctg123 . mRNA     1300 9000 . + . ID=mRNA00003;Parent=gene00001
```

3) The mRNA from the following will be called "mRNA00003"

```
ctg123 . gene      1000 9000 . + . ID=gene00001
ctg123 . mRNA     1300 9000 . + . ID=mRNA00003;Parent=gene00001
```

4) The mRNA from the following will be called "gene00001"

```
ctg123 . gene      1000 9000 . + . ID=gene00001
ctg123 . mRNA     1300 9000 . + . Parent=gene00001
```

5) The mRNA from the following mRNA without a parent gene will be called "mRNA"

```
ctg123 . mRNA     1300 9000 . + .
```

Figure 6.6: Naming of features.

Merged CDS features have a slightly different naming scheme. First, if a CDS feature in the GFF3 file has more than one parent, we create one CDS feature in the workbench for each parent, and each is merged with all other CDS features from the GFF3 file that has the parent feature as parent as well. The naming is then done in the following prioritized order:

1. the "Name" of the feature, if all the constituent CDS features have the same "Name".
2. the "Name" of the first named parent of the feature, if it has a name.
3. the "Name" of the first of the merged CDS features with a name.

4. the "ID" of the first of the merged CDS features with an ID.
5. the "ID" of the parent.

For features with the same ID, the naming scheme is as follows:

1. the "Name" of the feature, if all have the same "Name".
2. If there is a set of common parents for the features and one of the common parents have a "Name", the name of the first common parent with a "Name" is used.
3. If at least one feature has a name, the name of the first feature with the name is used.
4. the "ID" of the first of the features

Limits of the GFF3 importer

Features are imported only if their SeqID (i.e., the value in the first column of the gff3) can be matched to the name of a chromosome in the genome. Matching need not be exact (see section [1.1.6](#)). However, in some cases it may be necessary to manually edit either the names of the genomic sequences (for example in a fasta file), or the SeqIDs in the GFF3 file so that they match. Features without a match aren't imported. You can see the number of skipped features in the importer log.

The start and stop position of a feature cannot extend beyond the ends of a chromosome, unless the chromosome is explicitly marked as circular, which is indicated by << and >> at the beginning and the end of the sequence.

Trying to import such a file will fail. One option is to delete the feature that extends beyond the end of the chromosome and to start the import again. Another option is to make the track circular. To do so, convert the linear track into a sequence using the "Convert from Tracks" tool. Open the sequence and right-click on its name to be able to choose the option "Make sequence circular" from the drop-down menu. Convert the now circular sequence back into a track using the "Convert to Tracks" tool. Importing the gff3 should now be working.

The following instances are not supported:

- Interpreting SOFA accession numbers. The type of the feature is constrained to be either: (a) a term from the "lite" sequence ontology, SOFA; or (b) a SOFA accession number, distinguished using the syntax SO:000000. The importer recognizes terms from SOFA as well as terms from the full Sequence Ontology, but will not translate accession numbers to types. So for example, features with type SO:0000316 will not be interpreted as "CDS" but will be handled like any other type.
- The fasta directive ##FASTA. This FASTA section situated at the end of a GFF3 file specifies sequences of ESTs as well as of contigs. The GFF3 importer will ignore these sequences.
- Alignments. An aligned feature is handled as a single region, with the Gap and Target attributes added as annotations. We do not use Gap and Target to show how the feature aligns.
- Comment lines. We do not interpret lines beginning with a #. Especially relevant are lines "##sequence-region seqid start end" which some parsers use to perform bounds checking of features. Our bounds checking is instead performed against the user-supplied genome.

6.3 Import high-throughput sequencing data

The *CLC Genomics Workbench* has dedicated tools for importing data from the following High-throughput sequencing systems.

- Roche 454
- Illumina's Genome Analyzer, HiSeq and MiSeq
- PacBio
- SOLiD (read mapping is performed in color space, see section 24.4)
- Ion Torrent
- Complete Genomics (only processed data - master var and evidence files)

The reason for having dedicated tools for this is to standardize the data so that most downstream analyses and visualization of the data works seamlessly with all sequencing platforms. In case a sequence list was not imported with the right tool, it is possible to edit "Read Group" information in the "Element Info" view: choose from the drop-down menu the sequencing platform that was used to generate the data (figure 6.7) and click OK.

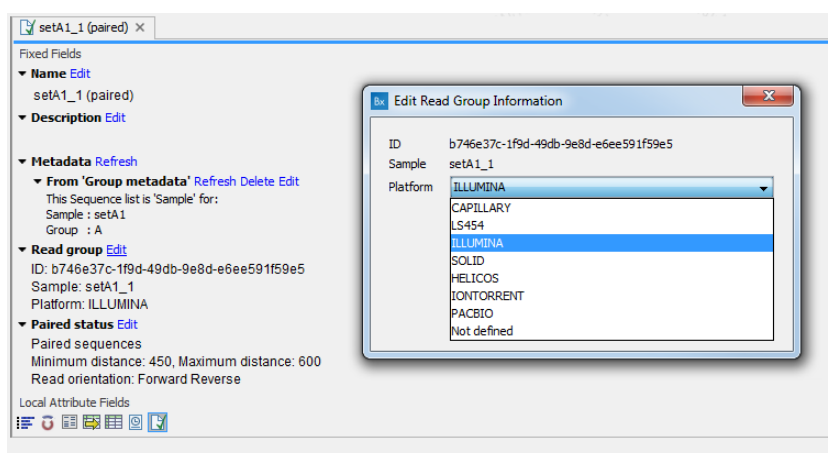

Figure 6.7: Editing the platform that was used to generate the data in the "Element Info" view.

In addition to these formats, mapped data in SAM/BAM format can also be imported.

This section will describe the various importers in detail.

Clicking on the **Import** (📁) button in the top toolbar will bring up a list of the supported data types as shown in figure 6.8.

Select the appropriate format and then fill in the information as explained in the following sections.

Please note that alignments of *Complete Genomics* data can be imported using the SAM/BAM importer, see section 6.3.8 below.

6.3.1 Roche 454

Choosing the Roche 454 import will open the dialog shown in figure 6.9.

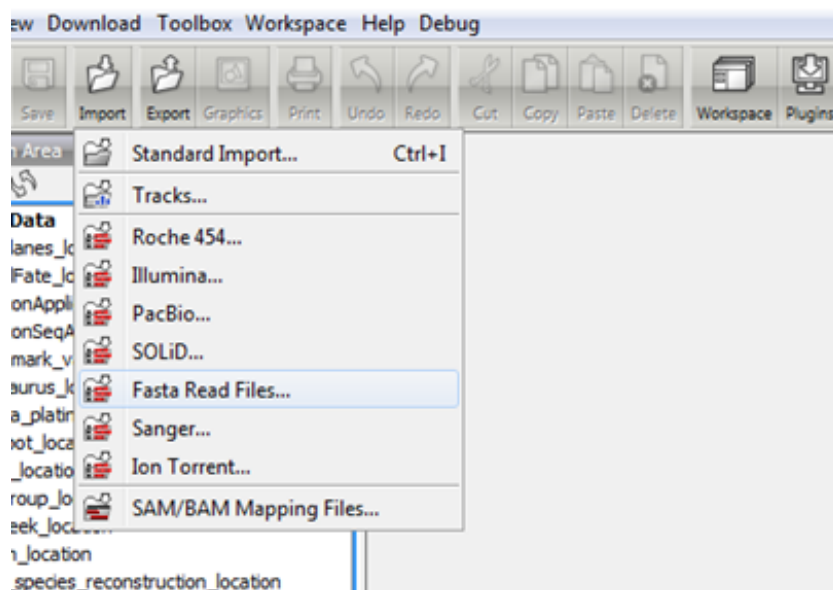

Figure 6.8: Choosing what kind of data you wish to import.

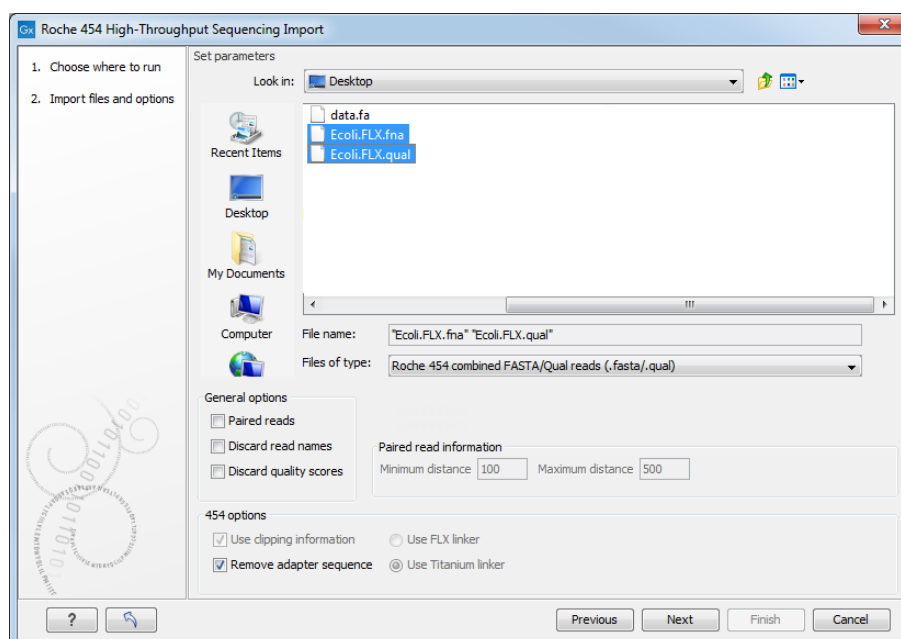

Figure 6.9: Importing data from Roche 454.

We support import of two kinds of data from 454 GS FLX systems:

- Flowgram files (`.sff`) which contain both sequence data and quality scores amongst others. However, the flowgram information is currently not used by *CLC Genomics Workbench*. There is an extra option to make use of clipping information (this will remove parts of the sequence as specified in the `.sff` file).
- Fasta/qual files:
 - 454 FASTA files (`.fna`) which contain the sequence data.
 - Quality files (`.qual`) which contain the quality scores.

For all formats, compressed data in gzip format is also supported (.gz).

The **General options** to the left are:

- **Paired reads.** The paired protocol for 454 entails that the forward and reverse reads are separated by a linker sequence. During import of paired data, the linker sequence is removed and the forward and reverse reads are separated and put into the same sequence list (their status as forward and reverse reads is preserved). You can change the linker sequence in the **Preferences** (in the **Edit** menu) under **Data**. Since the linker for the FLX and Titanium versions are different, you can choose the appropriate protocol during import, and in the preferences you can supply a linker for both platforms (see figure 6.10). Note that since the FLX linker is palindromic, it will only be searched on the plus strand, whereas the Titanium linker will be found on both strands. Some of the sequences may not have the linker in the middle of the sequence, and in that case the partial linker sequence is still removed, and the single read is put into a separate sequence list. Thus when you import 454 paired data, you may end up with two sequence lists: one for paired reads and one for single reads. Note that for de novo assembly projects, only the paired list should be used since the single reads list may contain reads where there is still a linker sequence present but only partially due to sequencing errors. Read more about handling paired data in section 6.3.9.
- **Discard read names.** For high-throughput sequencing data, the naming of the individual reads is often irrelevant given the huge amount of reads. This option allows you to discard this option to save disk space.
- **Discard quality scores.** Quality scores are visualized in the mapping view and they are used for SNP detection. If this is not relevant for your work, you can choose to **Discard quality scores**. One of the benefits from discarding quality scores is that you will gain a lot in terms of reduced disk space usage and memory consumption. If you have selected the *fna/qual* option and choose to discard quality scores, you do not need to select a .qual file.

Note! During import, partial adapter sequences are removed (TCAG and ATGC), and if the full sequencing adapters GCCTTGCCAGCCCGCTCAG, GCCTCCCTCGCGCCATCAG or their reverse complements are found, they are also removed (including tailing Ns). If you do not wish to remove the adapter sequences (e.g. if they have already been removed by other software), please uncheck the **Remove adapter sequence** option.

Click **Next** to adjust how to handle the results (see section 8.2). We recommend choosing **Save** in order to save the results directly to a folder, since you probably want to save anyway before proceeding with your analysis. There is an option to put the import data into a separate folder. This can be handy for better organizing subsequent analysis results and for batching (see section 8.3).

6.3.2 Illumina

The *CLC Genomics Workbench* supports data from Illumina's Genome Analyzer, HiSeq 2000 and the MiSeq systems. Choosing the Illumina import will open the dialog shown in figure 6.11.

File format The file formats accepted are:

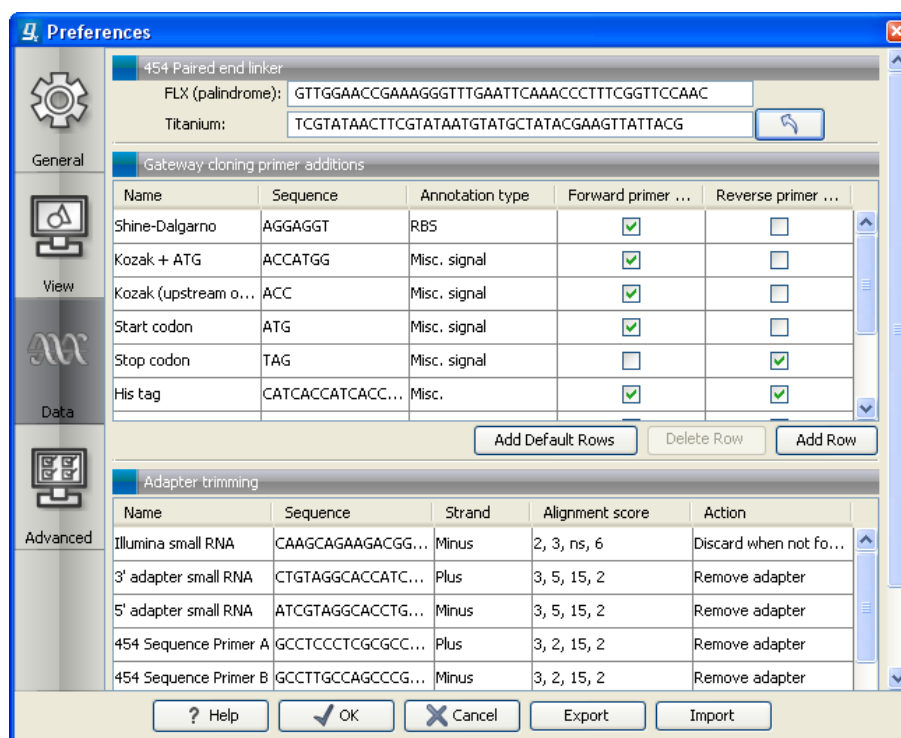

Figure 6.10: Specifying linkers for 454 import.

- Fastq
- Scarf
- Qseq
- For all formats, compressed data in gzip format is also supported (.gz).

Paired data in any of these formats can be imported.

Note that there is information inside qseq and fastq files specifying whether a read has passed a quality filter or not. If you check **Remove failed reads** these reads will be ignored during import. For qseq files there is a flag at the end of each read with values 0 (failed) or 1 (passed). In this example, the read is marked as failed and if Remove failed reads is checked, the read is removed.

```
M10 68 1 1 28680 29475 0 1 CATGGCCGTACAGAAACACACATCATAGCATCACACGA BBBBBBBBBBBBBBBBBBBBBBBBBBBBBBBBBBBBBBBBBBBBBBBBBBBBB 0
```

For fastq files, part of the header information for the quality score has a flag where Y means failed and N means passed. In this example, the read has not passed the quality filter:

```
@EAS139:136:FC706VJ:2:2104:15343:197393 1:Y:18:ATCACG
```

Note! In the **Illumina pipeline 1.5-1.7**, the letter B in the quality score has a special meaning. 'B' is used as a trim clipping. This means that when selecting Illumina pipeline 1.5-1.7, the reads are automatically trimmed when a B is encountered at either end of the reads in the input file. This will happen also if you choose to discard quality scores during import.

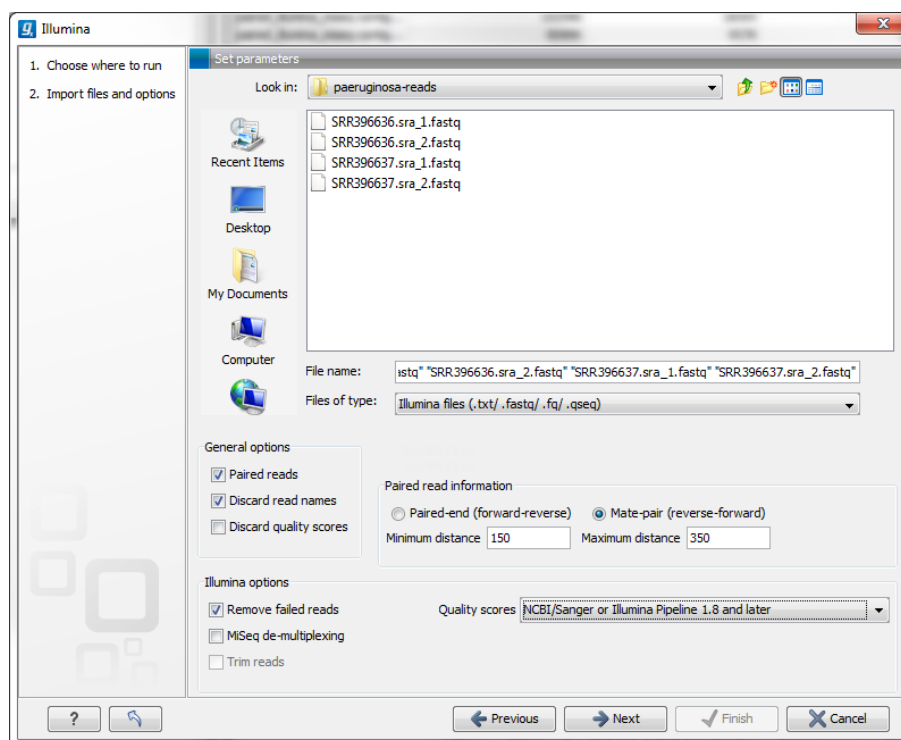

Figure 6.11: Importing data from Illumina systems.

General Options The **General options** to the left are:

- **Paired reads.** For paired import, you can select whether the data is **Paired-end** or **Mate-pair**. For paired data, the Workbench expects the first reads of the pairs to be in one file and the second reads of the pairs to be in another. So, for example, if you had specified that the pairs were in forward-reverse orientation, then the first file would be assumed to contain the forward reads. The second file would be assumed to contain the reverse reads.

When loading files containing paired data, the *CLC Genomics Workbench* sorts the files selected according to rules based on the file naming scheme:

- For files coming off the CASAVA1.8 pipeline, we organize pairs according to their identifier and chunk number. Files named with `_R1_` are assumed to contain the first sequences of the pairs, and those with `_R2_` in the name are assumed to contain the second sequence of the pairs.
- For other files, we sort them all alphanumerically, and then group them two by two. This means that files 1 and 2 in the list are loaded as pairs, files 3 and 4 in the list are seen as pairs, and so on.

In the simplest case, the files are typically named as shown in figure 6.11. In this case, the data is paired end, and the file containing the forward reads is called `s_1_1_sequence.txt` and the file containing reverse reads is called `s_1_2_sequence.txt`. Other common filenames for paired data, like `_1_sequence.txt`, `_1_qseq.txt`, `_2_sequence.txt` or `_2_qseq.txt` will be sorted alphanumerically. In such cases, files containing the final `_1` should contain the first reads of a pair, and those containing the final `_2` should contain the second reads of a pair.

For files from CASAVA1.8, files with base names like these: ID_R1_001, ID_R1_002, ID_R2_001, ID_R2_002 would be sorted in this order:

1. ID_R1_001
2. ID_R2_001
3. ID_R1_002
4. ID_R2_002

The data in files ID_R1_001 and ID_R2_001 would be loaded as a pair, and ID_R1_002, ID_R2_002 would be loaded as a pair.

Within each file, the first read of a pair will have a 1 somewhere in the information line. In most cases, this will be a /1 at the end of the read name. In some cases though (e.g. CASAVA1.8), there will be a 1 elsewhere in the information line for each sequence. Similarly, the second read of a pair will have a 2 somewhere in the information line - either a /2 at the end of the read name, or a 2 elsewhere in the information line.

If you do not choose to discard your read names on import (see next parameter setting), you can quickly check that your paired data has imported in the pairs you expect by looking at the first few sequence names in your imported paired data object. The first two sequences should have the same name, except for a 1 or a 2 somewhere in the read name line.

Paired-end and mate-pair data are handled the same way with regards to sorting on filenames. Their data structure is the same the same once imported into the Workbench. The only difference is that the expected orientation of the reads: reverse-forward in the case of mate pairs, and forward-reverse in the case of paired end data. Read more about handling paired data in section [6.3.9](#).

- **Discard read names.** For high-throughput sequencing data, the naming of the individual reads is often irrelevant given the huge amount of reads. This option allows you to discard read names to save disk space.
- **Discard quality scores.** Quality scores are visualized in the mapping view and they are used for SNP detection. If this is not relevant for your work, you can choose to **Discard quality scores**. One of the benefits from discarding quality scores is that you will gain a lot in terms of reduced disk space usage and memory consumption. Read more about the quality scores of Illumina below.

Paired read information These options become available if you selected the option "Paired reads" in the General options. First, it is very important to select the correct nature of the paired reads imported: Paired-end (forward-reverse) or Mate-pair (reverse-forward). Second, you have to specify the Minimum and Maximum distances for your pairs. The paired read distance includes the full read sequence, which means that is from the beginning of the forward read to the beginning of the reverse read (figure [6.12](#)). The distances are usually defined during the library preparation of your sequencing experiment, but in doubt you can enter default values: for paired-end the distances are between 1 and 1000 bp while mate-pair reads typically have longer distances between 1000-5000 bp (and sometimes up to 10000). Note that the tools usually used subsequently to process Illumina reads (such as "Map Reads to Reference" or "RNA-Seq Analysis") have an "Auto-detect paired distances" option that is enabled by default. As long as this option is used, mis-specifying the distances during import should bear no consequences.

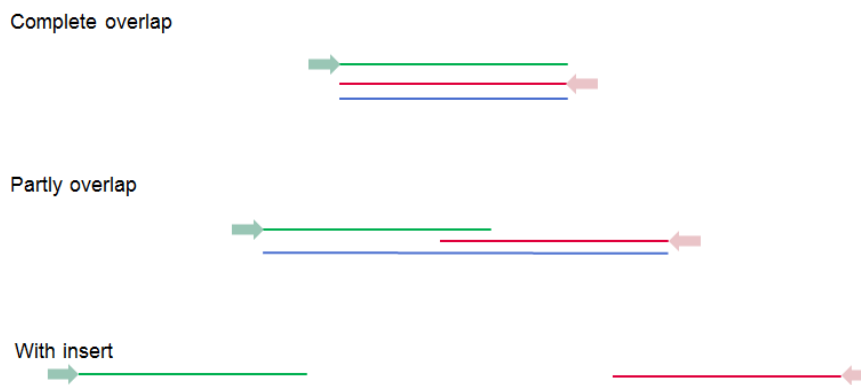

Figure 6.12: Green lines represent forward reads, red lines reverse reads, and in blue is shown the distance of the sequenced DNA fragment. Thus, if there is a complete overlap, the minimum distance will not be 0, but the length of the overlap.

Illumina options

- **Remove failed reads.** If you check **Remove failed reads**, reads that did not pass a quality filter (in qseq and fastq files) will be ignored during import. For more information on format specific quality filters see section on file format above). If you import paired data and one read in a pair is removed during import, the remaining mate will be saved in a separate sequence list with single reads.
- **MiSeq de-multiplexing.** For MiSeq multiplexed data, one file includes all the reads containing barcodes/indices from the different samples (in case of paired data it will be two files). Using this option, the data can be divided into groups based on the barcode/index. This is typically the desired behavior, because subsequent analysis can then be executed in batch on all the samples and results can be compared at the end. This is not possible if all samples are in the same file after import. The reads are connected to a group using the last number in the read identifier.
- **Trim reads.** This option applies to Illumina Pipeline 1.5 to 1.7. In this pipeline, the value 2 (B) has special meaning and is used as a trim clipping. This means that when selecting Illumina Pipeline 1.5 and later, the reads are trimmed when a B is encountered at either end of the reads in the input file if the **Trim reads** option is checked.

Click **Next** to adjust how to handle the results (see section 8.2). We recommend choosing **Save** in order to save the results directly to a folder, since you probably want to save anyway before proceeding with your analysis. There is an option to put the import data into a separate folder. This can be handy for better organizing subsequent analysis results and for batching (see section 8.3).

Quality scores in the Illumina platform

The quality scores in the FASTQ format come in different versions. You can read more about the FASTQ format at http://en.wikipedia.org/wiki/FASTQ_format. When you select to import Illumina data and click **Next** there is an option to use different quality score schemes at the bottom of the dialog (see figure 6.13).

There are four options:

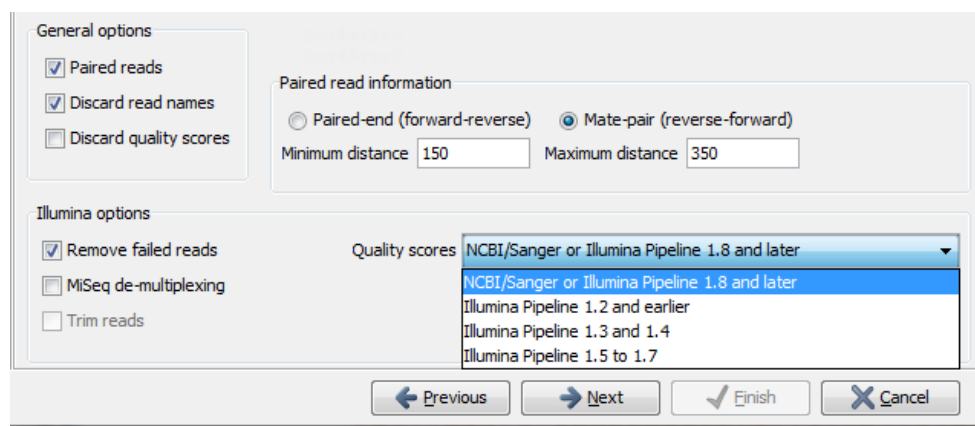

Figure 6.13: Selecting the quality score scheme.

- **NCBI/Sanger or Illumina 1.8 and later.** Using a Phred scale encoded using ASCII 33 to 93. This is the standard for fastq formats except for the early Illumina data formats (this changed with version 1.8 of the Illumina Pipeline).
- **Illumina Pipeline 1.2 and earlier.** Using a Solexa/Illumina scale (-5 to 40) using ASCII 59 to 104. The Workbench automatically converts these quality scores to the Phred scale on import in order to ensure a common scale for analyses across data sets from different platforms (see details on the conversion next to the sample below).
- **Illumina Pipeline 1.3 and 1.4.** Using a Phred scale using ASCII 64 to 104.
- **Illumina Pipeline 1.5 to 1.7.** Using a Phred scale using ASCII 64 to 104. Values 0 (@) and 1 (A) are not used anymore. Value 2 (B) has special meaning and is used as a trim clipping. This means that when selecting Illumina Pipeline 1.5 and later, the reads are trimmed when a B is encountered at either end of the reads in the input file if the **Trim reads** option is checked.

Small samples of three kinds of files are shown below. The names of the reads have no influence on the quality score format:

NCBI/Sanger Phred scores:

```
@SRR001926.1 FC00002:7:1:111:750 length=36
TTTTTGTAAAGGAGGGGGTTCATCAAAATTTGCAAAA
+SRR001926.1 FC00002:7:1:111:750 length=36
IIIIIIIIIIIIIIIIIIIIIIIIIIIFIIII' IB<IH
@SRR001926.7 FC00002:7:1:110:453 length=36
TTATATGGAGGCTTTAAGAGTTCATAGGTTGTTCCCC
+SRR001926.7 FC00002:7:1:110:453 length=36
IIIIIIIIIII:' III?=IIIIII+&III/3I8F/&
```

Illumina Pipeline 1.2 and earlier (note the question mark at the end of line 4 - this is one of the values that are unique to the old Illumina pipeline format):

```
@SLXA-EAS1_89:1:1:672:654/1
GCTACGGAATAAAACCAGGAACAACAGACCCAGCA
```

```
+SLXA-EAS1_89:1:1:672:654/1
cccccccccccccccccccc]c``cVcZccbSYb?
@SLXA-EAS1_89:1:1:657:649/1
GCAGAAAATGGGAGTGAATCTCCGATGAGCAGC
+SLXA-EAS1_89:1:1:657:649/1
ccccccccccbcbbcbcb``ccbcccZcc``bR^`
```

The formulas used for converting the special Solexa-scale quality scores to Phred-scale:

$$Q_{phred} = -10 \log_{10} p$$

$$Q_{solexa} = -10 \log_{10} \frac{p}{1-p}$$

A sample of the quality scores of the Illumina Pipeline 1.3 and 1.4:

```
@HWI-E4_9_30WAF:1:1:8:178
GCCAGCGGCGCAAAATGNCGGCGGCGATGACCTTC
+HWI-E4_9_30WAF:1:1:8:178
babaaaa\ababaaaaREXabaaaaaaaaaaaaaaaa
@HWI-E4_9_30WAF:1:1:8:1689
GATGGAGATCTCGACCTNATAGGTGCCCTCATCGG
+HWI-E4_9_30WAF:1:1:8:1689
aab `]_aaaaaaaaaa [ER`abaaa\aaaaaaaaa [
```

Note that it is not possible to see from that data itself that it is actually not Illumina Pipeline 1.2 and earlier, since they use the same range of ASCII values.

To learn more about ASCII values, please see http://en.wikipedia.org/wiki/Ascii#ASCII_printable_characters.

6.3.3 PacBio

Choosing the PacBio import will open the dialog shown in figure 6.14.

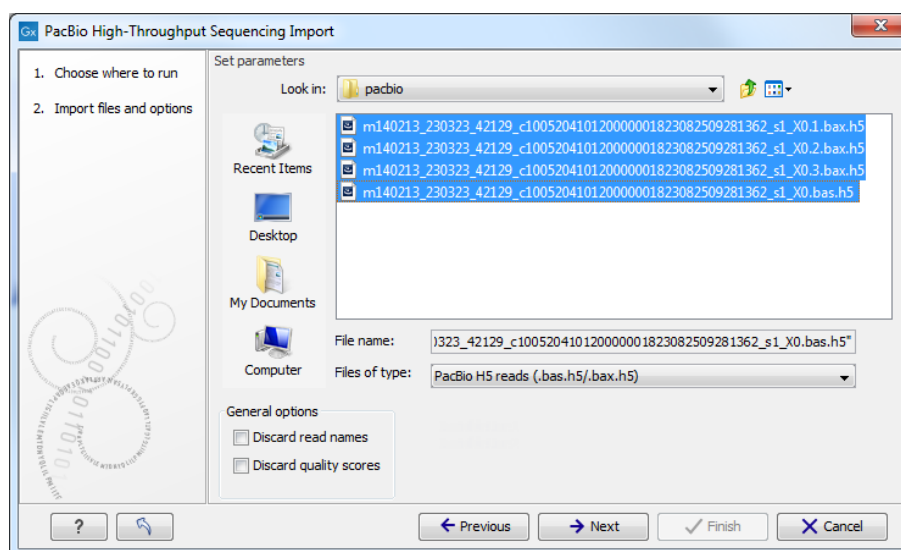

Figure 6.14: Importing data from PacBio. ".bas.h5", ".fastq" and ".fasta" files are supported

We support import of three file formats containing PacBio reads:

- H5 files (`.bas.h5`/`.bax.h5`) which contain one of two things. `.bas.h5` files produced by instruments prior to PacBio RS II contain sequencing data such as reads and quality scores. `.bas.h5` files from more recent PacBio instruments contain a list of `.bax.h5` files where the actual sequencing data is stored. When importing H5 files, the user needs to select both the `.bas.h5` file and all the accompanying `.bax.h5` files belonging to a data set.
- Fastq files (`.fastq`) which contain sequence data and quality scores. Compressed Fastq (`.fastq.gz`) files are also supported.
- Fasta files (`.fasta`) which contain sequence data. Compressed Fasta (`.fasta.gz`) files are also supported.

Under **General options** you have the following choices:

- **Discard read names.** For high-throughput sequencing data, the naming of the individual reads is often irrelevant given the huge amount of reads. This option allows you to discard read names to save disk space.
- **Discard quality scores.** Quality scores can be visualized in the mapping view and used for SNP detection. If this is not relevant for your work, you can choose to **Discard quality scores**. Discarding quality scores will reduce both disk space usage and memory consumption. As PacBio quality scores currently contain very little information, we recommend that you discard them. When importing Fasta files, this option is not available, since Fasta files do not contain quality scores.

Click **Next** and choose how the result of the import should be handled. We recommend choosing **Save** which will save the results directly to the disk.

When opening the "Element info" of sequence lists imported with the PacBio importer, the item "Platform" will display the mention PACBIO. For PacBio reads imported without the PacBio importer, it is possible to edit that field to "PACBIO" by clicking **Edit** next to the "Read Group" section in the Element Info view. Having the platform set to PacBio will ensure that the read mapper will perform better on PacBio reads.

6.3.4 SOLiD

Choosing the SOLiD import will open the dialog shown in figure 6.15.

There are two formats accepted: the XSQ format which is the native format of newer SOLiD systems, and the csfasta format which is the color space version of fasta format.

The XSQ format

An XSQ file can contain results from multiple libraries produced from the same sequencing run. These are identified by a barcode on each read, and when the XSQ file is produced, each read is placed into its appropriate library based on its barcode. The XSQ importer creates separate sequence lists for each library.

Sometimes when an XSQ file is produced, a barcode cannot be identified accurately enough to place the read into a specific library, or the read is for some other reason not assigned to a library. In this case, the read is placed into an "Unclassified" or "Unassigned" library.

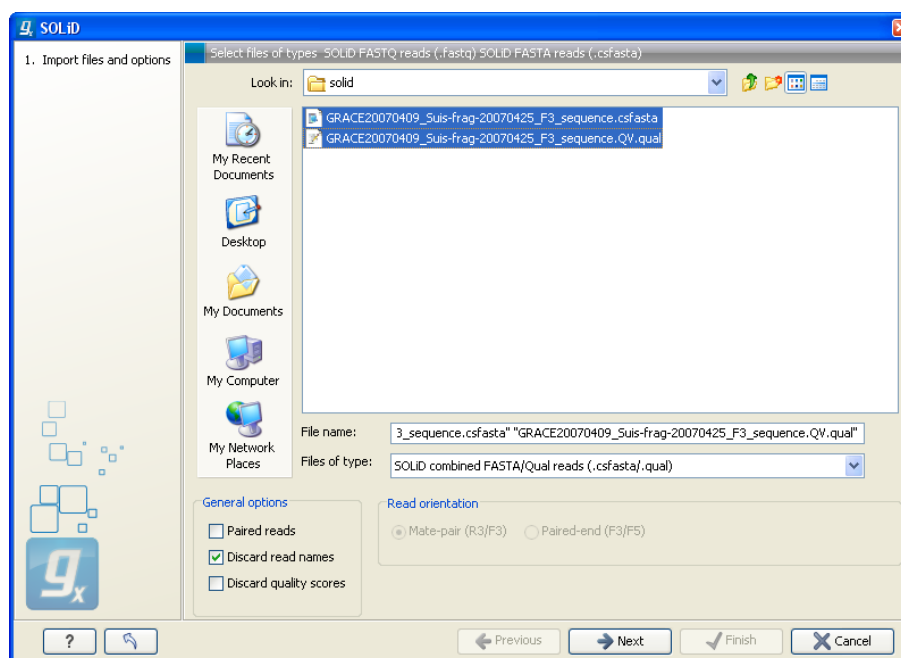

Figure 6.15: Importing data from SOLiD.

In the case of paired reads, it sometimes happens that one read of a pair could not be read. When the XSQ file is imported in the *CLC Genomics Workbench*, the other read of such a pair is placed into a sequence list with " (single)" appended to the name, whereas all intact pairs are placed (alternating) into a sequence list with " (paired)" appended to the name. Thus, two sequence lists are produced for the library.

Hence, when importing data in XSQ format the number of imported files can vary. In the example shown here, where the XSQ file contain a library with the name "Main" (containing paired reads) and an "Unclassified" library (containing reads where e.g. the barcode could not be read), the imported data are segregated into the following sequence lists:

1. Main (single)
2. Main (paired)
3. Unclassified

An XSQ file sometimes contains reads in both base space and color space, and when that is the case, each read library in the XSQ file that contains reads in both formats will result in two files, with " (base space)" and " (color space)" appended to their names, respectively.

The csfasta format

If you want to import quality scores with csfasta files, qual files should also be provided. The reads in a csfasta file look like this:

```
>2_14_26_F3
T011213122200221123032111221021210131332222101
>2_14_192_F3
T110021221100310030120022032222111321022112223
```

The **General options** to the left are:

- **Paired reads.** When you import paired data, the Workbench expects the first reads of the pairs to be in one file and the second reads of the pairs to be in another. When importing one pair of files, the first file in a pair will be assumed to contain the first reads of the pair, and the second file is assumed to contain the second read in a pair. Two different protocols are supported:
 - **Mate-pair.** For mate-pair data, the reads should be in two files with `_F3` and `_R3` in front of the file extension. The orientation of the reads is expected to be forward-forward.
 - **Paired-end.** For paired-end data, the reads should be in two files with `_F3` and `_F5-P2` or `_F5-BC`. The orientation is expected to be forward-reverse.

Read more about handling paired data in section 6.3.9. Please note that for XSQ files, the pairing protocol is defined in the file itself, which means that the choices of protocol will be ignored.

An example of a complete list of the four files needed for a SOLiD mate-paired data set including quality scores:

```
dataset_F3.csfasta   dataset_F3.qual
dataset_R3.csfasta   dataset_R3.qual
```

or

```
dataset_F3.csfasta   dataset_F3_.QV.qual
dataset_R3.csfasta   dataset_R3_.QV.qual
```

- **Discard read names.** For high-throughput sequencing data, the naming of the individual reads is often irrelevant given the huge amount of reads. This option allows you to discard this option to save disk space.
- **Discard quality scores.** Quality scores are visualized in the mapping view and they are used for SNP detection. If this is not relevant for your work, you can choose to **Discard quality scores**. One of the benefits from discarding quality scores is that you will gain a lot in terms of reduced disk space usage and memory consumption. If you choose to discard quality scores, you do not need to select a `.qual` file when importing `csfasta` files.

Click **Next** to adjust how to handle the results (see section 8.2). We recommend choosing **Save** in order to save the results directly to a folder, since you probably want to save anyway before proceeding with your analysis. There is an option to put the import data into a separate folder. This can be handy for better organizing subsequent analysis results and for batching (see section 8.3).

6.3.5 Fasta read files

The **Fasta** importer is designed for high volumes of read data such as high-throughput sequencing data (NGS reads). When using this import option the read names can be included but the

descriptions from the fasta files are ignored. For import of other fasta format data, such as reference sequences, please use the  **Standard Import**, described in section 6 as this import format also includes the descriptions.

The dialog for importing data in fasta format is shown in figure 6.17.

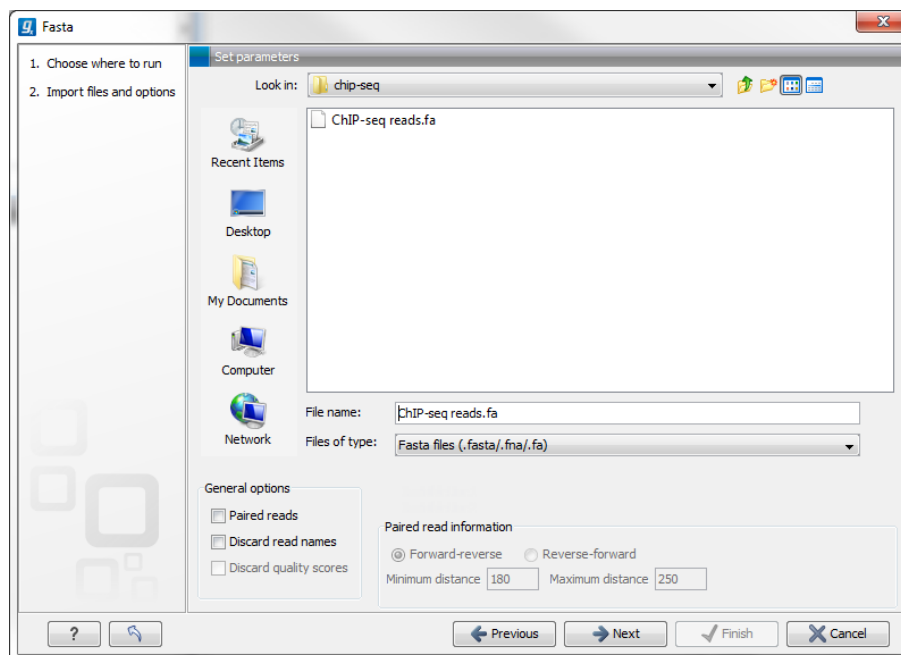

Figure 6.17: Importing data in fasta format.

Compressed data in gzip format is also supported (.gz).

The **General options** to the left are:

- **Paired reads.** For paired import, the Workbench expects the forward reads to be in one file and the reverse reads in another. The Workbench will sort the files before import and then assume that the first and second file belong together, and that the third and fourth file belong together etc. At the bottom of the dialog, you can choose whether the ordering of the files is **Forward-reverse** or **Reverse-forward**. As an example, you could have a data set with two files: `sample1_fwd` containing all the forward reads and `sample1_rev` containing all the reverse reads. In each file, the reads have to match each other, so that the first read in the `fwd` list should be paired with the first read in the `rev` list. Note that you can specify the insert sizes when importing paired read data. If you have data sets with different insert sizes, you should import each data set individually in order to be able to specify different insert sizes. Read more about handling paired data in section 6.3.9.
- **Discard read names.** For high-throughput sequencing data, the naming of the individual reads is often irrelevant given the huge amount of reads. This option allows you to discard this option to save disk space.
- **Discard quality scores.** This option is not relevant for fasta import, since quality scores are not supported.

Click **Next** to adjust how to handle the results (see section 8.2). We recommend choosing **Save** in order to save the results directly to a folder, since you probably want to save anyway before

proceeding with your analysis. There is an option to put the import data into a separate folder. This can be handy for better organizing subsequent analysis results and for batching (see section 8.3).

6.3.6 Sanger sequencing data

Although traditional sequencing data (with chromatogram traces like abi files) is usually imported using the standard **Import** (📁), see section 6, this option has also been included in the High-Throughput Sequencing Data import. It is designed to handle import of large amounts of sequences, and there are three differences from the standard import:

- All the sequences will be put in one sequence list (instead of single sequences).
- The chromatogram traces will be removed (quality scores remain). This is done to improve performance, since the trace data takes up a lot of disk space and significantly impacts speed and memory consumption for further analysis.
- Paired data is supported.

With the standard import, it is practically impossible to import up to thousands of trace files and use them in an assembly. With this special High-Throughput Sequencing import, there is no limit. The import formats supported are the same: ab, abi, ab1, scf and phd.

For all formats, compressed data in gzip format is also supported (.gz).

The dialog for importing data Sanger sequencing data is shown in figure 6.18.

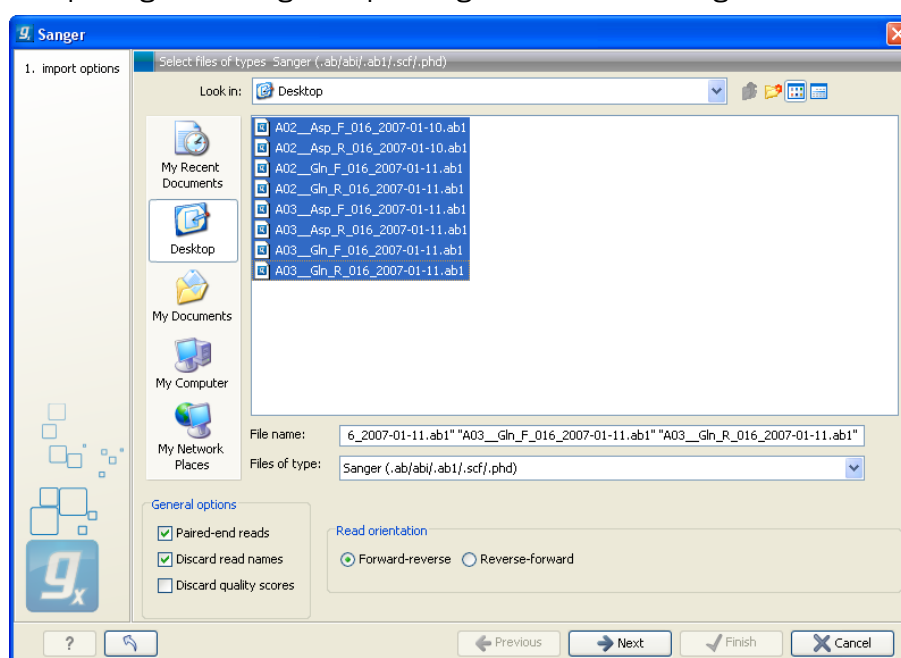

Figure 6.18: Importing data from Sanger sequencing.

The **General options** to the left are:

- **Paired reads.** The Workbench will sort the files before import and then assume that the first and second file belong together, and that the third and fourth file belong together etc. At the

bottom of the dialog, you can choose whether the ordering of the files is **Forward-reverse** or **Reverse-forward**. As an example, you could have a data set with two files: `sample1_fwd` for the forward read and `sample1_rev` for the reverse reads. Note that you can specify the insert sizes when importing paired read data. If you have data sets with different insert sizes, you should import each data set individually in order to be able to specify different insert sizes. Read more about handling paired data in section 6.3.9.

- **Discard read names.** For high-throughput sequencing data, the naming of the individual reads is often irrelevant given the huge amount of reads. This option allows you to discard this option to save disk space.
- **Discard quality scores.** Quality scores are visualized in the mapping view and they are used for SNP detection. If this is not relevant for your work, you can choose to **Discard quality scores**. One of the benefits from discarding quality scores is that you will gain a lot in terms of reduced disk space usage and memory consumption.

Click **Next** to adjust how to handle the results (see section 8.2). We recommend choosing **Save** in order to save the results directly to a folder, since you probably want to save anyway before proceeding with your analysis. There is an option to put the import data into a separate folder. This can be handy for better organizing subsequent analysis results and for batching (see section 8.3).

6.3.7 Ion Torrent

Choosing the Ion Torrent import will open the dialog shown in figure 6.19.

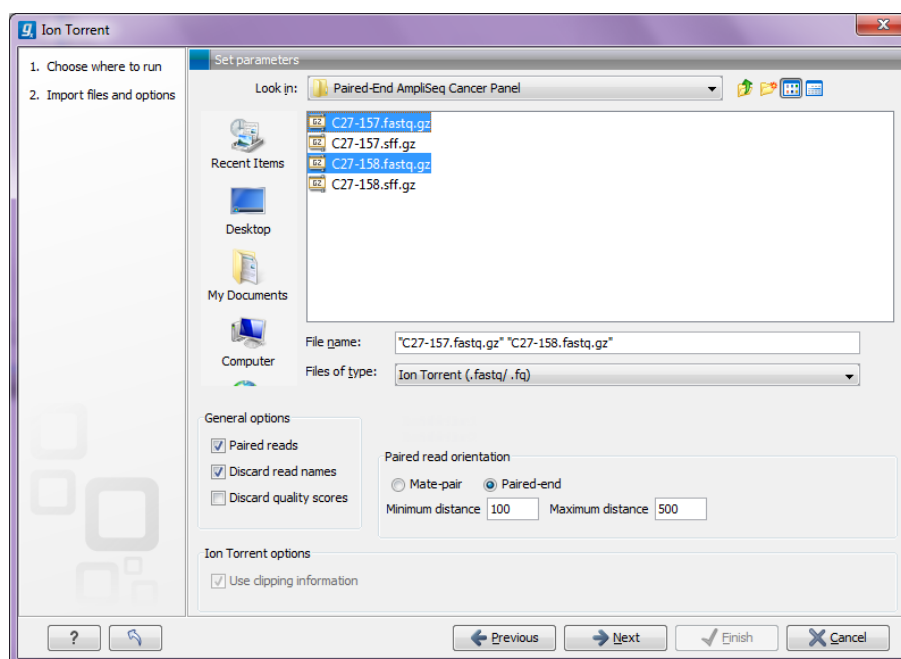

Figure 6.19: Importing data from Ion Torrent.

We support import of two kinds of data from the Ion Torrent system:

- SFF files (`.sff`) providing extra information on adapters or regions of low quality

- Fastq files (`.fastq`). Quality scores are expected to be in the NCBI/Sanger format (see section 6.3.2)

For all formats, compressed data in gzip format is also supported (`.gz`).

The **General options** to the left are:

- **Paired reads.** The *CLC Genomics Workbench* supports both paired end and mate pair protocols.

Paired end Paired end data from Ion Torrent comes in two files per data set. The first file in is assumed to contain the first reads of the pair, and the second file is assumed to contain the second read in a pair. On import, the orientation of the reads is set to forward - reverse. When the reads have been imported, there will be one file with intact pairs, and one file where one part of the pair is missing (in this case, "single" is appended to the file name). The Workbench connects the right sequences together in the pair based on the read name. Read more about handling paired data in section 6.3.9.

Mate pair Mate pair reads from Ion torrent are Reverse-Forward and usually between 2,000 and 10,000 bp. The mate pair protocol for Ion Torrent entails that the two reads are separated by a linker sequence. During import of paired data, the linker sequence is removed and the two reads are separated and put into the same sequence list. You can change the linker sequence in the **Preferences** (in the **Edit** menu) under **Data**. When looking for the linker sequence, the Workbench requires 80 % of the maximum alignment score, using the following scoring scheme: matches = 1, mismatches = -2 and indels = -3. Some of the sequences may not have the linker in the middle of the sequence, and in that case the partial linker sequence is still removed, and the single read is put into a separate sequence list. Thus when you import Ion Torrent mate pair data, you may end up with two sequence lists: one for paired reads and one for single reads. Note that for de novo assembly projects, only the paired list should be used since the single reads list may contain reads where there is still a linker sequence present but only partially due to sequencing errors. Read more about handling paired data in section 6.3.9.

- **Discard read names.** For high-throughput sequencing data, the naming of the individual reads is often irrelevant given the huge amount of reads. This option allows you to discard this option to save disk space.
- **Discard quality scores.** Quality scores are visualized in the mapping view and they are used for SNP detection. If this is not relevant for your work, you can choose to **Discard quality scores**. One of the benefits from discarding quality scores is that you will gain a lot in terms of reduced disk space usage and memory consumption. If you have selected the `fna/qual` option and choose to discard quality scores, you do not need to select a `.qual` file.

For `sff` files, you can also decide whether to use the clipping information in the file or not.

6.3.8 Complete Genomics

With *CLC Genomics Workbench 10.0* you can import *evidence* and *variation* files from Complete Genomics.

The variation files can be imported as tracks (see section 6.2).

The evidence files can be imported using the SAM/BAM importer, see section 6.3.10.

In order to import the evidence data file it need to be converted first. This is achieved using the CGA tools that can be downloaded from <http://www.completegenomics.com/sequence-data/cgatools/>.

The procedure for converting the data is the following.

1. Download the human genome in fasta format and make sure the chromosomes are named chr<number>.fa, e.g. chr9.fa.
2. Run the **fasta2crr** tool with a command like this:

```
cgatools fasta2crr --input chr9.fa --output chr9.crr
```
3. Run the **evidence2sam** tool with a command like this:

```
cgatools evidence2sam --beta -e evidenceDnbs-chr9-.tsv -o chr9.sam -s chr9.crr
```

 where the .tsv file is the evidence file provided by Complete Genomics (you can find sample data sets on their ftp server: <ftp://ftp.completegenomics.com/>).
4. **Import** (📁) the fasta file from 1. into the Workbench.
5. Use the SAM/BAM importer (section 6.3.10) to import the file created by the evidence2sam tool.

Please refer to the CGA documentation for a description about these tools.

6.3.9 General notes on handling paired data

During import, information about paired data (distances and orientation) can be specified (see figure 6.8 and figure 6.11 for data import examples of Roche 454 and Illumina reads, respectively) and is stored by the *CLC Genomics Workbench*. All subsequent analyses automatically take differences in orientation into account. Once imported, both reads of a pair will be stored in the same sequence list. The forward and reverse reads (e.g. for paired-end data) simply alternate so that the first read is forward, the second read is the mate reverse read; the third is again forward and the fourth read is the mate reverse read and so on. When manipulating sequence lists with paired data, be careful not break this order.

You can view and edit the orientation of the reads after they have been imported by opening the read list in the Element information view (📄), see section 10.4 as shown in figure 6.20.

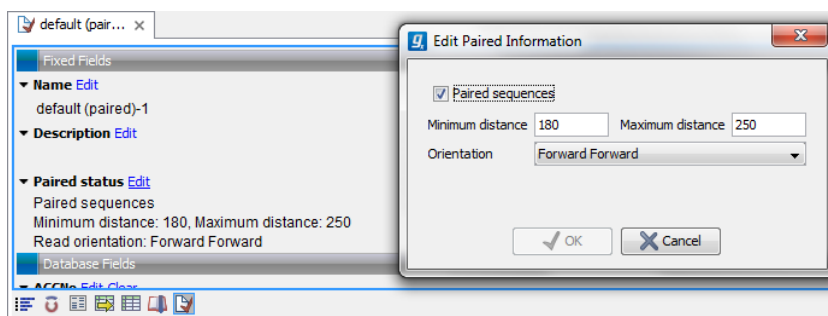

Figure 6.20: The paired orientation and distance.

In the **Paired status** part, you can specify whether the *CLC Genomics Workbench* should treat the data as paired data, what the orientation is and what the preferred distance is. The orientation and preferred distance is specified during import and can be changed in this view. If the "Paired sequences" box is unchecked, the sequences will be handled as single (non paired) data.

Note that the **paired distance** measure that is used throughout the *CLC Genomics Workbench* is always including the full read sequence. For paired-end libraries it means from the beginning of the forward read to the beginning of the reverse read.

6.3.10 SAM and BAM mapping files

The *CLC Genomics Workbench* supports import and export of files in SAM (Sequence Alignment/Map) and BAM format, which are designed for storing large nucleotide sequence alignments. Read more and see the format specification at <http://samtools.sourceforge.net/>

The *CLC Genomics Workbench* includes support for importing SAM and BAM files from **Complete Genomics**.

Note! If you wish to import the reads in a SAM/BAM file as a sequence list, disregarding any mapping information, please use the Standard import tool instead (see section 6.1).

For a detailed explanation of the SAM and BAM files exported from *CLC Genomics Workbench*, please see Appendix J.

Input data for importing a mapping from a SAM/BAM file

To import a mapping from a SAM/BAM file containing mapping data into the Workbench, you need to:

- Provide the SAM/BAM file
- Specify the reference sequences that are referred to within that file. The references can either be sequences already imported into the Workbench, or, if appropriately recorded in the SAM/BAM file, can be fetched from URLs specified in the SAM/BAM file.

The mapping is built up within the Workbench using the reference sequence data, the reads and the information from the SAM/BAM file about how the reads are associated with a particular reference.

Data created in the Workbench after importing a SAM/BAM mapping file



- Reads recorded as mapping to a particular reference that is known inside the Workbench are imported as part of the mapping for that reference.
- Reads recorded as not mapping to any reference are imported into a sequence list.
 - If they are part of an intact pair, they are imported into a sequence list of paired data.
 - If they are single reads or a member of a pair that did not map while its mate did, they are imported into a sequence list containing single reads.

One list is made per read group, with the potential that several such lists could be produced from a single mapping import. The sequence lists are given names of this form for single

reads "<read group id> [read group sample] (single) un-mapped reads" and this form for paired reads "<read group id> [read group sample] (paired) un-mapped reads".

If you do not wish to import the unmapped reads, deselect the **Import unmapped reads** option in the final step of the tool dialog.

- Reads recorded as mapping to a reference sequence that is **not** known within the Workbench are not imported.

When setting up the import, you are given the option of creating a track-based mapping, or a stand-alone mapping. In the latter case, if there is only one reference sequence, the result will be a single read mapping (). When there is more than one reference sequence, a multi-mapping object () is created.

Please note that mappings within the *CLC Genomics Workbench* do not allow for an individual read sequence to map to more than one location. In cases where a SAM/BAM file contains multiple alignment records for a single read, only one such record will be used to build the mapping.

Running the SAM/BAM Mapping Files importer

Click on the Import button on the toolbar or go to:

File | Import () | SAM/BAM Mapping Files ()

This will open a dialog where you select the SAM/BAM file to import as well as the reference sequences to be used (Figure 6.21).

When you select the reference sequence(s) two options exist:

1. Select a matching reference sequence that has already been imported into the Workbench. Click on the "Find in folder" icon () to localize the reference sequence.
2. If the SAM/BAM file already contains information about where to find the reference sequence, tick the "Download references" box to automatically download the reference sequence.

The selected reference sequence(s) will be listed under "References in files" with "Name", "Length", and "Status". Whenever the correct reference sequence (with the correct name and sequence length) has been selected the "Status" field will indicate this with an "OK". The length of your reference sequence must **match exactly** the length of the reference specified in the SAM/BAM file. The name is more flexible as it allows a range of different "synonyms" (with no distinction between capital and lowercase letters). E.g. for chromosome 1 the allowed synonyms would be: 1, chr1, chromosome_1, nc_000001, for chromosome M: m, mt, chrm, chrmt, chromosome_m, chromosome_mt, nc_001807, for chromosome X: x, chrx, chromosome_x, nc_000023, and for chr Y: y, chry, chromosome_y, nc_000024.

If there are inconsistencies in the names or lengths of the reference sequences being chosen and those recorded in the SAM/BAM file, an entry will appear in the "Status" column indicating this. E.g. "Length differs" or "Input missing"¹.

¹If you are using a CLC Genomics Server to import files located on the Server (rather than locally), then checks for corresponding reference names and lengths cannot be carried out, so nothing will be reported in this section of the Wizard. This means you will be able to continue to launch the import with correct or incorrect reference sets specified. However, any inconsistencies in these will lead to the import task failing with an error related to this.

Unmatched reads (reads that are mapped to an unmatched reference e.g. a SAM reference for which there is no CLC reference counterpart) are not imported. The same is the case whenever inconsistencies have occurred with respect to name or length. The log lists all mapping data or unmatched reads that were not imported and marks whether import failed because of unmatched reads being present in the SAM/BAM file or because of inconsistencies in name/length.

Some notes regarding reference sequence naming Reference sequences in a SAM/BAM file **cannot contain spaces**. If the name of a reference sequence in the Workbench contains spaces, the Workbench assume that the names of the references in the SAM file will be the same as the names of the References within the Workbench, but with all spaces removed. For example, if your reference sequence in the Workbench was called `my reference sequence`, the Workbench would recognize a reference in the SAM file as the appropriate reference if it was of the same length and had the name `myreferencesequence`.

Neither the @ character nor the = character are allowed within reference sequence names in SAM files. Any instances of these characters in the name of a reference sequence in the Workbench will be replaced with a _ for the sake of identifying the appropriate reference when importing a SAM or BAM file. For example, if a reference sequence in the Workbench was called `my=reference@sequence`, the Workbench would recognize a reference in the SAM file as the appropriate reference if it was of the same length and had the name `my_reference_sequence`.

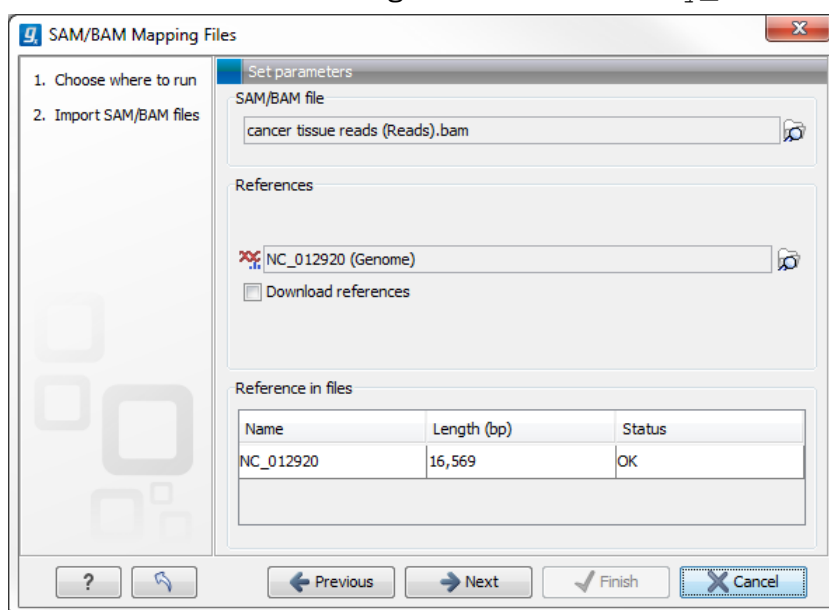

Figure 6.21: Defining SAM/BAM file and reference sequence(s).

Click **Next** to specify how to handle the results (Figure 6.22). Under **Output options** the "Save downloaded reference sequence" will be enabled if the "Download references" box was ticked in the previous step (which would be the case when the SAM/BAM file contained information about where to find the reference sequence e.g. if the SAM/BAM file came from an external provider).

Ticking the "Create Reads Track" box results in the generation of a track-based mapping. Alternatively, the "Create Stand-Alone Read Mapping" results in a normal read mapping file. By ticking the "Import unmapped reads" box, a sequence list of the unmapped reads will be created. To avoid importing unmapped reads, untick this box.

We recommend choosing **Save** in order to save the results directly to a folder, as you will probably

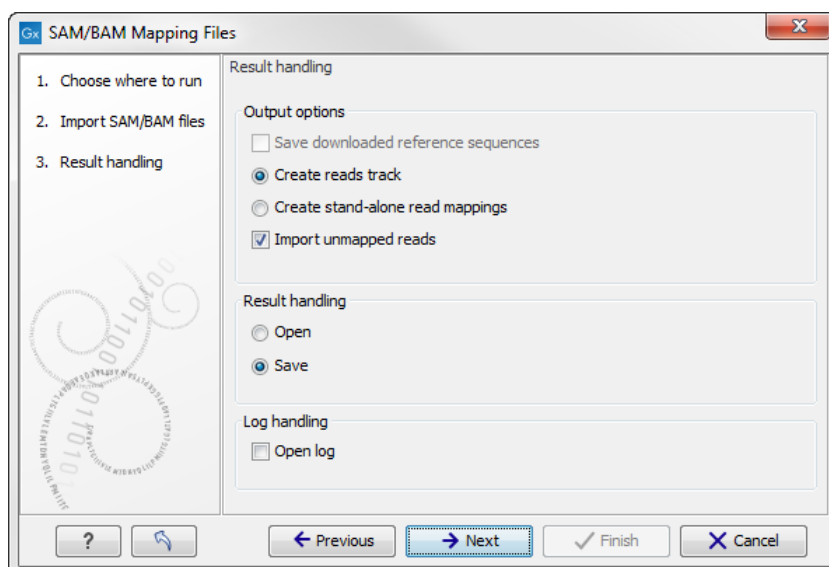

Figure 6.22: Specify the result handling.

wish to save the data anyway before proceeding with your analysis. For further information about how to handle the results, (see section 8.2).

Note that this import operation is very memory-consuming for large data sets, and particularly those with many reads marked as members of broken pairs in the mapping.

6.4 Import RNA spike-in controls

The *CLC Genomics Workbench* has a dedicated tool for importing RNA spike-in control data: **Import | RNA Spike-ins**

The wizard offers the option to import a standard ERCC file as provided by Thermo Fisher Scientific, or a custom made one (figure 6.23).

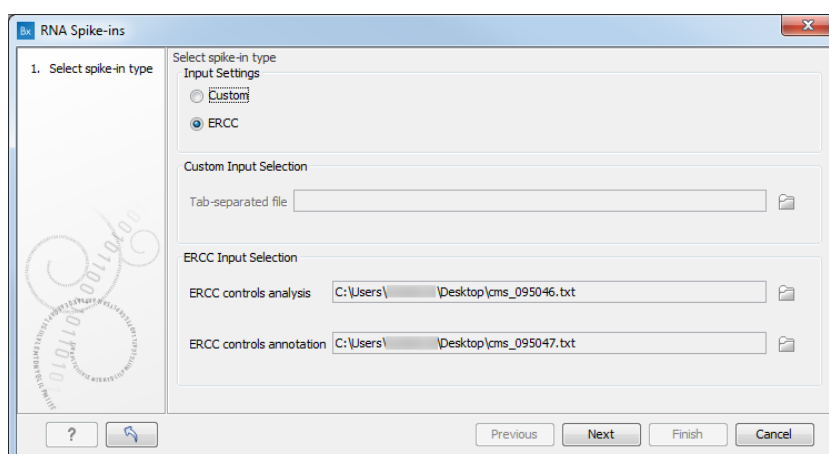

Figure 6.23: The RNA spike-in controls importer.

To import a standard ERCC file, look for **ERCC Controls Analysis** and **ERCC Control Annotation** files on the Thermo Fisher Scientific website, download both *.txt files on your computer, and start the importer. Select the option "ERCC" and specify the location of the analysis and annotation files in the relevant "ERCC Input Selection" fields at the bottom of the wizard.

For **custom-made spike-in controls**, choose the "Custom" option and specify in the "Custom Input Selection" field a tab-separated file (*.tsv or *.txt) containing the spike-in data organized as such: sequence name in the first column, nucleotide sequence in the second column, followed by as many columns as necessary to contain the concentrations of the spike-in measures in attomoles/microliters. Concentrations must not contain commas: write 15000 instead of 15,000. Remove any white space and save the table as a tab-separated TSV or TXT file on your computer.

It is also possible to import Lexogen Spike-in RNA Variant Control Mixes by modifying the SIRV files to fit the custom file requirements. Download the **SIRV sequence design overview (XLSX)** from the Lexogen website and open it in Excel. In the annotation column, "c" designate the data that should be imported ("i" is under-annotated while "O" is over-annotated). Filter the table to only keep the rows having a 1 in the "c" column, then keep only - and in that order - the sequence name, nucleotide sequence and concentration columns of the remaining rows. Reformat the values to numerical values in attomoles/microliters before saving the table as a *.tsv file. Import the file in the workbench using the "Custom" option.

Once a spike-in file is specified, click **Next** and choose to **Save** the file in the Navigation Area for later use in RNA-Seq Analysis.

6.5 Data export

The exporter can be used to:

- Export bioinformatic data in most of the formats that can be imported. There are a few exceptions (see section [I.1](#)).
- Export one or more data elements at a time to a given format. When multiple data elements are selected, each is written out to an individual file, unless compression is turned on, or "Output as single file" is selected.

The standard export functionality can be launched using the Export button on the toolbar, or by going to the menu:

File | Export 

An additional export tool is available from under the File menu:

File | Export with Dependent Elements

This tool is described further in section [6.5.2](#).

The general steps when configuring a standard export job are:

- (Optional) Select the data to export in the **Navigation Area**.
- Start up the exporter tool via the Export button in the toolbar or using the **Export** option under the File menu.
- Select the format the data should be exported to.
- Select the data to export, or confirm the data to export if it was already selected via the **Navigation Area**.

- Configure the parameters. This includes compression, multiple or single outputs, and naming of the output files, along with other format-specific settings where relevant.
- Select where the data should be exported to.
- Click on the button labeled **Finish**.

Selecting data for export - part I. You can select the data elements to export **before** you run the export tool **or after** the format to export to has been selected. If you are not certain which formats are supported for the data being exported, we recommend selecting the data in the **Navigation Area** before launching the export tool.

Selecting a format to export to. When data is pre-selected in the **Navigation Area** before launching the export tool you will see a column in the export interface called **Supported formats**. Formats that the selected data elements can be exported to are indicated by a "Yes" in this column. Supported formats will appear at the top of the list of formats (figure 6.24).

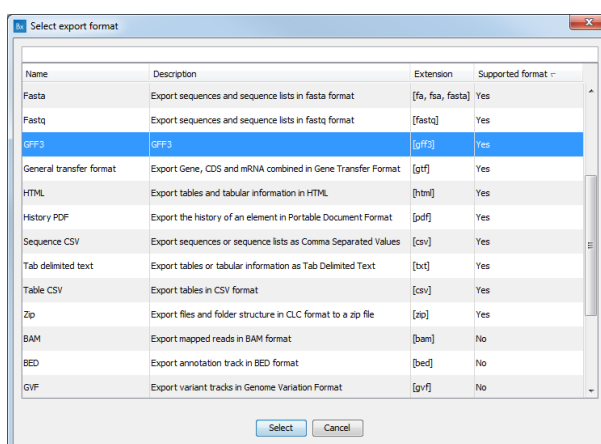

Figure 6.24: The Select exporter dialog where sequence lists were pre-selected in the Navigation Area before launching the export tool. Here, the formats sequence lists can be exported to are listed at the top, with a Yes in the Selected formats column. Other formats are found below, with No in this column.

Formats that cannot be used for export of the selected data have a "No" listed in the **Supported formats** column. If you have selected multiple data elements of different types, then formats which can be used for some of the selected data elements but not all of them are indicated by the text "For some elements" in this column.

Please note that the information in the **Supported formats** column only refers to the data already selected in the **Navigation Area**. If you are going to choose your data later in the export process, then the information in this column will not be pertinent.

Only one export format is available if you select a folder to be exported. This is described in more detail in section 6.5.1.

Finding a particular format in the list. You can quickly find a particular format by using the text box at the top of the exporter window as shown in figure 6.25, where formats that include the term VCF are searched for. This search term will remain in place the next time the Export tool is launched. Just delete the text from the search box if you no longer wish only the formats with that term to be listed.

When the desired export format has been identified, click on the button labeled **Open**.

Selecting data for export - part II. A dialog appears, with a name reflecting the format you have chosen. For example if the "Variant Call Format" (VCF format) was selected, the window is labeled "Export VCF".

If you are logged into a CLC Server, you will be asked whether to run the export job using the Workbench or the Server. After this, you are provided with the opportunity to select or de-select data to be exported.

In figure 6.26 we show the selection of a variant track for export to VCF format.

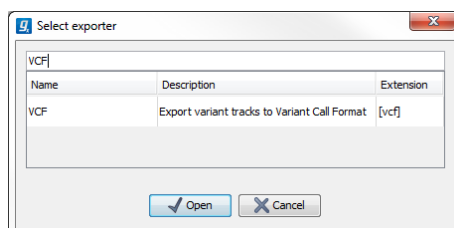

Figure 6.25: The text field has been used to search for VCF format in the Select exporter dialog.

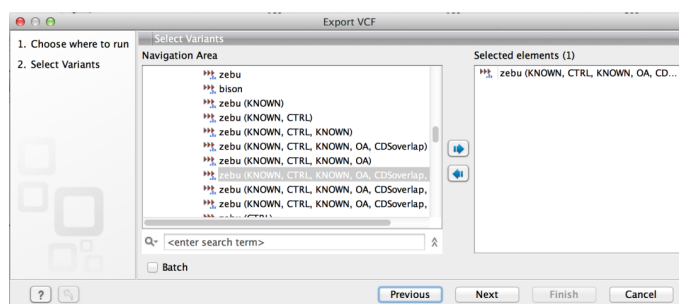

Figure 6.26: The Select exporter dialog. Select the data element(s) to export.

The parameters under **Basic export parameters** and **File name** are offered when exporting to any format.

There may be additional parameters for particular export formats. This is illustrated here with the VCF exporter, where a reference sequence track must be selected (see figure 6.27). To learn more about VCF specific export format, please read section 1.1.6.

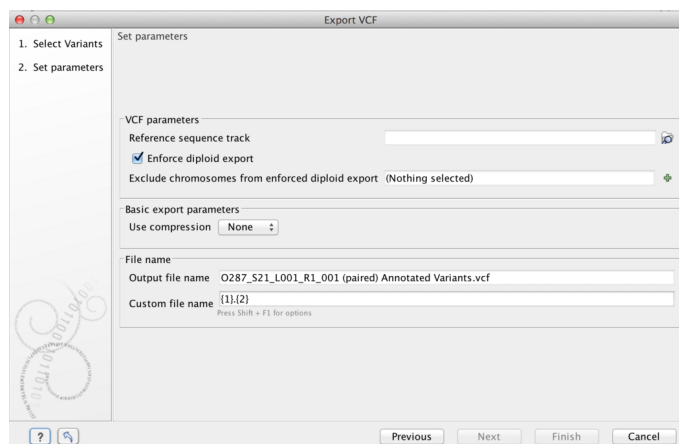

Figure 6.27: Set the export parameters. When exporting in VCF format, a reference sequence track must be selected.

Compression options. Within the **Basic export parameters** section, you can choose to compress the exported files. The options are no compression (None), gzip or zip format. Choosing zip format results in all data files being compressed into a single file. Choosing gzip compresses the exported file for each data element individually.

Exporting multiple files. If you have selected multiple files of the same type, you can choose to export them in one single file (only for certain file formats) by selecting "Output as single file" in the **Basic export parameters** section. If you wish to keep the files separate after export, make sure this box is not ticked. **Note:** Exporting in zip format will export only one zipped file, but the files will be separated again when unzipped.

Choosing the exported file name(s) The default setting for the **File name** is to use the original data element name as the basename and the export format as the suffix.

When exporting just one data element, or exporting to a zip file, the desired filename could just be typed in the Custom file name box.

When working with the export of multiple files, using some combination of the terms shown by default in this field and in figure 6.30 are recommended. Clicking in the **Custom file name** field with the mouse and then simultaneously pressing the Shift + F1 keys bring up a list of the available terms that can be included in this field.

The following placeholders are available:

- **{input}** or **{1}** - default name of the data element being exported
- **{extension}** or **{2}** - default extension for the chosen export format
- **{counter}** or **{3}** - a number that is incremented per file exported. i.e. If you export more than one file, counter is replaced with 1 for the first file, 2 for the next and so on.
- **{user}** - name of the user who launched the job
- **{host}** - name of the machine the job is run on
- **{year}**, **{month}**, **{day}**, **{hour}**, **{minute}**, and **{second}** - timestamp information based on the time an output is created. Using these placeholders, items generated by a workflow at different times can have different filenames.

We will look at an example to illustrate this: In this example we would like to change the export file format to .fasta in a situation where .fa was the default format that would be used if you kept the default file extension suggestion ("{2}"). To do this replace "{2}" with ".fasta" in the "Custom file name field". You can see that when changing "{2}" to ".fasta" , the file name extension in the "Output file name" field automatically changes to the new format (see figure 6.28).

When deciding on an output name, you can choose any combination of the different placeholders as well as custom names and punctuation, as in `{input}({day}-{month}-{year})`. Another example of a meaningful name to a variant track could be `{2} variant track` as shown in figure 6.29. If your workflow input is named `Sample 1`, the result would be "Sample 1 variant track".

As you add or remove text and terms in the **Custom file name** field, the text in the **Output file name** field will change so you can see what the result of your naming choice will be for your data. When working with multiple files, only the name of the first one is shown. Just move the

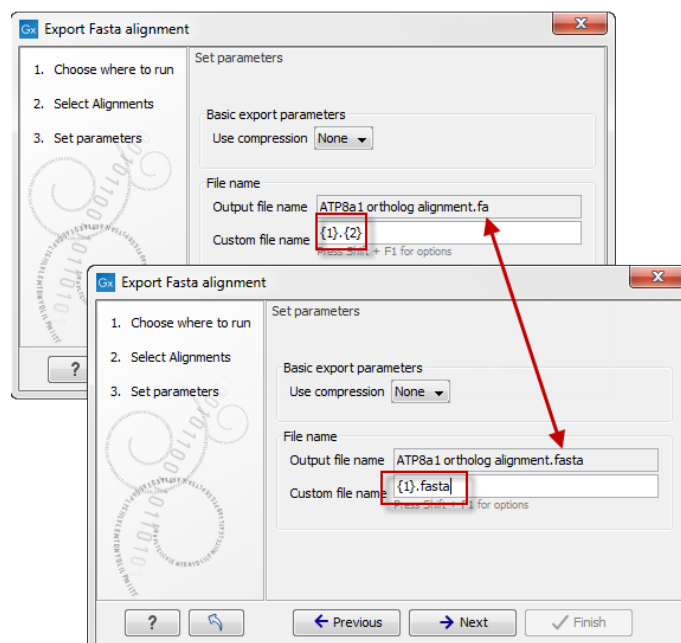

Figure 6.28: The file name extension can be changed by typing in the preferred file name format.

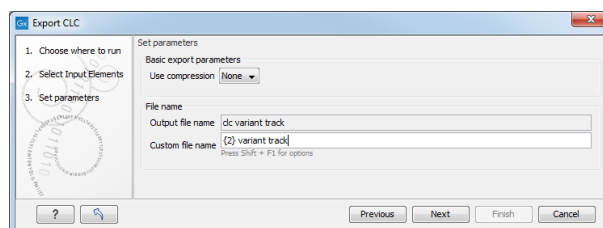

Figure 6.29: Providing a custom name for the result.

mouse cursor over the name shown in the **Output file name** field to show a listing of the all the filenames.

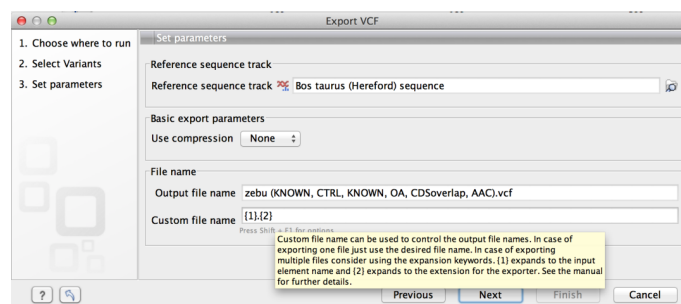

Figure 6.30: Use the custom file name pattern text field to make custom names.

The last step is to specify the exported data should be saved (figure 6.31).

A note about decimals and Locale settings. When exporting to CSV and tab delimited files, decimal numbers are formatted according to the Locale setting of the Workbench (see section 4.1). If you open the CSV or tab delimited file with spreadsheet software like Excel, you should make sure that both the Workbench and the spreadsheet software are using the same Locale.

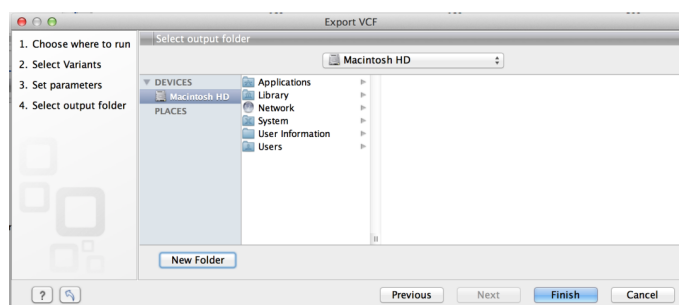

Figure 6.31: Select where to save the exported data.

6.5.1 Export of folders and multiple elements in CLC format

In the list of export formats presented is one called zip format. Choosing this format means that you wish to export the selected data element(s) or folders to a single, compressed CLC format file. This is useful in cases where you wish to exchange data between workbenches or as part of a simple backup procedure.

A zip file generated this way can be imported directly into a workbench using the Standard Import tool and leaving the import type as Automatic.

Note! When exporting multiple files, the names will be listed in the "Output file name" text field with only the first file name being visible and the rest being substituted by "...", but will appear in a tool tip if you hover the mouse over that field (figure 6.32).

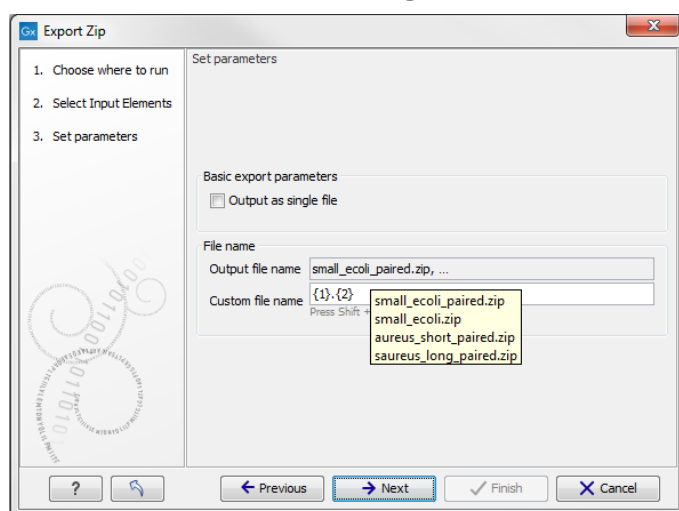

Figure 6.32: The output file names are listed in the "Output file name" text field.

6.5.2 Export of dependent elements

Sometimes it can be useful to export the results of an analysis and its dependent elements. That is, the results along with the data that was used in the analysis. For example, one might wish to export an alignment along with all the sequences that were used in generating that alignment.

To export a data element with its dependent elements:

- Select the parent data element (like an alignment) in the **Navigation Area**.
- Start up the exporter tool by going to **File | Export with Dependent Elements**.

- Edit the output name if desired and select where the resulting zip format file should be exported to.

The file you export contains compressed CLC format files containing the data element you chose and all its dependent data elements.

A zip file created this way can be imported directly into a CLC workbench by going to

File | Import | Standard Import

In this case, the import type can be left as Automatic.

6.5.3 Export history

Each data element in the Workbench has a history. The history information includes things like the date and time data was imported or an analysis was run, the parameters and values set, and where the data came from. For example, in the case of an alignment, one would see the sequence data used for that alignment listed. You can view this information for each data element by clicking on the Show History view () at the bottom of the viewing area when a data element is open in the Workbench.

This history information can be exported to a pdf document. To do this:

- (Optional, but preferred) Select the data element (like an alignment) in the **Navigation Area**.
- Start up the exporter tool via the Export button in the toolbar or using the **Export** option under the File menu.
- Select the **History PDF** as the format to export to (figure 6.33).
- Select the data to export, or confirm the data to export if it was already selected via the **Navigation Area**.
- Edit any parameters of interest, such as the Page Setup details, the output filename(s) and whether or not compression should be applied (figure 6.34).
- Select where the data should be exported to.
- Click on the button labeled **Finish**.

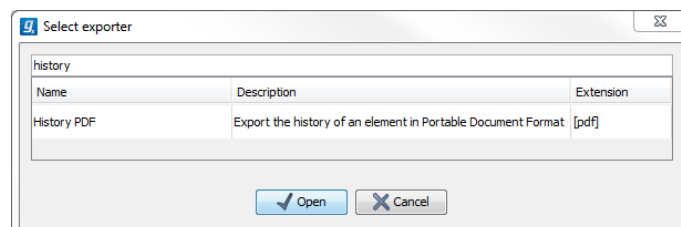

Figure 6.33: Select "History PDF" for exporting the history of an element.

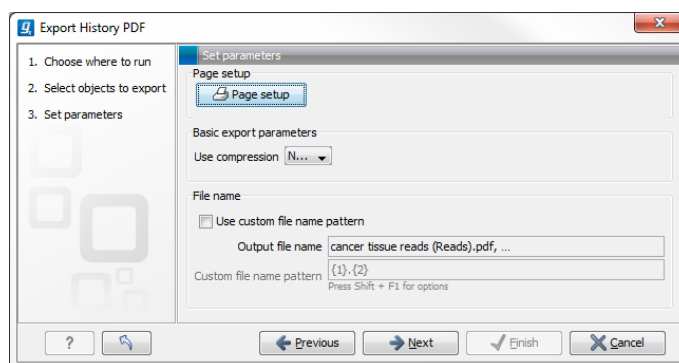

Figure 6.34: When exporting the history in PDF, it is possible to adjust the page setup.

6.5.4 The CLC format

The *CLC Genomics Workbench* stores bioinformatic data in CLC format. The CLC format contains data, as well as information about that data like history information and comments you may have added.

A given data element in the Workbench can contain different types of data. This is reflected when exporting data, as the choice of different export formats can lead to the extraction of some parts of that data object rather than others. The part of the data exported reflects the type of data a given format can support. As a simple example, if you export the results of an alignment to Annotation CSV format, you will get just the annotation information. If you exported to Fasta alignment format, you would get the aligned sequences in fasta format, but no annotations.

The CLC format holds all the information for a given data object. Thus if you plan to share the data with colleagues who also have a CLC Workbench or you are communicating with the CLC Support team and you wish to share the data from within the Workbench, exporting to CLC format is usually the best choice as all information associated with that data object in your Workbench will then be available to the other person who imports that data.

If you are planning to share your data with someone who does not have access to a CLC Workbench, then you will wish to export to another data format. Specifically, one they can use with the software they are working with.

6.5.5 Backing up data from the CLC Workbench

Regular backups of your data are advisable.

The data stored in your CLC Workbench is in the areas defined as CLC Data Locations. Whole data locations can be backed up directly (option 1) or, for smaller amounts of data, you could export the selected data elements to a zip file (option 2).

Option 1: Backing up each CLC Data Location

The easiest way for most people to find out where their data is stored is to put the mouse cursor over the top level directories, that is, the ones that have an icon like , in the **Navigation Area** of the Workbench. This brings up a tool tip with the system location for that data location.

To back up all your CLC data, please ensure that all your CLC Data Locations are backed up.

Here, if you needed to recover the data later, you could put add the data folder from backup as a data location in your Workbench. If the original data location is not present, then the data should

be usable directly. If the original data location is still present, the Workbench will re-index the (new) data location. For large volumes of data, re-indexing can take some time.

Information about your data locations can also be found in an xml file called `model_settings_300.xml`. This file is located in the settings folder in the user home area. Further details about this file and how it pertains to data locations in the Workbench can be found in the Deployment Manual: http://resources.qiagenbioinformatics.com/manuals/workbenchdeployment/current/index.php?manual=Changing_default_location.html.

Option 2: Export a folder of data or individual data elements to a CLC zip file

This option is for backing up smaller amounts of data, for example, certain results files or a whole data location, where that location contains smaller amounts of data. For data that takes up many gigabases of space, this method can be used, but it can be very demanding on space, as well as time.

Select the data items, including any folders, in the Navigation area of your Workbench and choose to export by going to:

File | Export (📁)

and choosing ZIP format.

The zip file created will contain all the data you selected. You can later re-import the zip file into the Workbench by going to:

File | Import (📁)

The only data files associated with the *CLC Genomics Workbench* not within a specified data location are BLAST databases. It is unusual to back up BLAST databases as they are usually updated relatively frequently and in many cases can be easily re-created from the original files or re-downloaded from public resources. If you do wish to backup your BLAST database files, they can be found in the folders specified in the BLAST Database Manager, which is started by going to: **Toolbox | BLAST | Manage BLAST databases**.

6.5.6 Export of tables

Tables can be exported in four different formats; CSV, tab-separated, Excel, or html.

When exporting a table in CSV, tab-separated, or Excel format, numbers with many decimals are printed in the exported file with 10 decimals, or in 1.123E-5 format when the number is close to zero.

Excel limits the number of hyperlinks in a worksheet to 66,530. When exporting a table of more than 66,530 rows, Excel will "repair" the file by removing all hyperlinks. If you want to keep the hyperlinks valid, you will need to export your data to several worksheets in batches smaller than 66,530 rows.

When exporting a table in html format, data are exported with the number of decimals that have been defined in the workbench preference settings. When tables are exported in html format from the server or using command line tools, the default number of exported decimals is 3.

The Excel exporters, the CSV and tab delimited exporters, and the HTML exporter have been extended with the ability to export only a sub-set of columns from the object being exported. Uncheck the option "Export all columns" and click next to see a new dialog window in which

columns to be exported can be selected (figure 6.35). You can choose them one by one or choose a predefined subset:

- All: will select all possible columns.
- None: will clear all preselected column.
- Default: will select the columns preselected by default by the software.
- Last export: will select all windows that were selected during the last export.
- Active editor (only if an active editor is currently open): the columns selected are the same than in the active editor window.

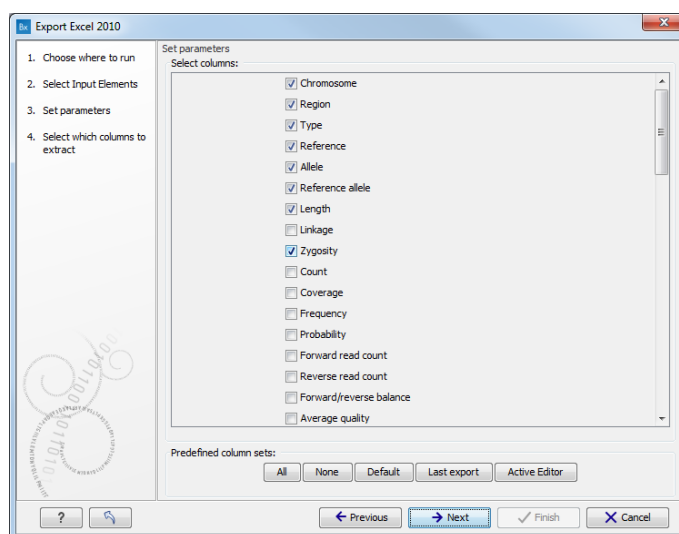

Figure 6.35: Selecting columns to be exported.

After selecting columns, the user will be directed to the output destination wizard page.

6.6 Export graphics to files

CLC Genomics Workbench supports export of graphics into a number of formats. This way, the visible output of your work can easily be saved and used in presentations, reports etc. The **Export Graphics** function (📄) is found in the **Toolbar**.

CLC Genomics Workbench uses a WYSIWYG principle for graphics export: What You See Is What You Get. This means that you should use the options in the Side Panel to change how your data, e.g. a sequence, looks in the program. When you export it, the graphics file will look exactly the same way.

It is not possible to export graphics of elements directly from the **Navigation Area**. They must first be opened in a view in order to be exported. To export graphics of the contents of a view:

select tab of View | Graphics (📄) on Toolbar

This will display the dialog shown in figure 6.36.

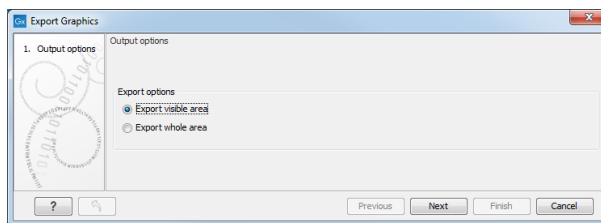

Figure 6.36: Selecting to export whole view or to export only the visible area.

6.6.1 Which part of the view to export

In this dialog you can choose to:

- **Export visible area**, or
- **Export whole view**

These options are available for all views that can be zoomed in and out. In figure 6.37 is a view of a circular sequence which is zoomed in so that you can only see a part of it.

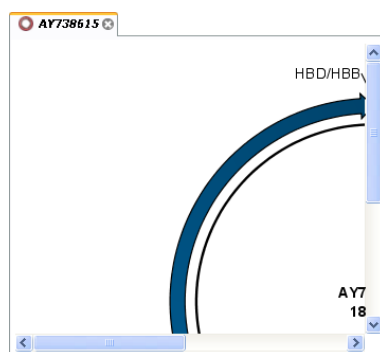

Figure 6.37: A circular sequence as it looks on the screen when zoomed in.

When selecting **Export visible area**, the exported file will only contain the part of the sequence that is *visible* in the view. The result from exporting the view from figure 6.37 and choosing **Export visible area** can be seen in figure 6.38.

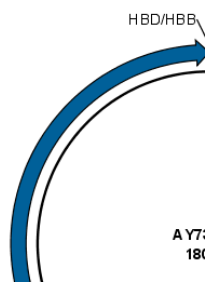

Figure 6.38: The exported graphics file when selecting Export visible area.

On the other hand, if you select **Export whole view**, you will get a result that looks like figure 6.39. This means that the graphics file will also include the part of the sequence which is not visible when you have zoomed in.

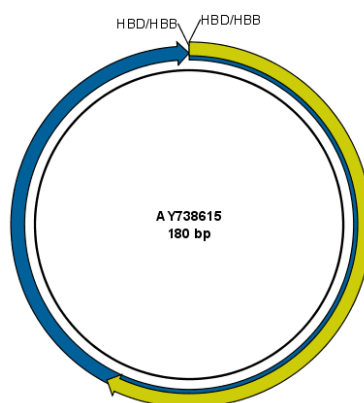

Figure 6.39: The exported graphics file when selecting *Export whole view*. The whole sequence is shown, even though the view is zoomed in on a part of the sequence.

For 3D structures, this first step is omitted and you will always export what is shown in the view (equivalent to selecting **Export visible area**).

Click **Next** when you have chosen which part of the view to export.

6.6.2 Save location and file formats

In this step, you can choose name and save location for the graphics file (see figure 6.40).

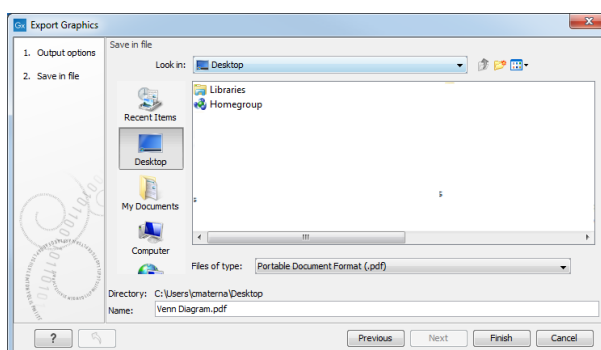

Figure 6.40: Location and name for the graphics file.

CLC Genomics Workbench supports the following file formats for graphics export:

Format	Suffix	Type
Portable Network Graphics	.png	bitmap
JPEG	.jpg	bitmap
Tagged Image File	.tif	bitmap
PostScript	.ps	vector graphics
Encapsulated PostScript	.eps	vector graphics
Portable Document Format	.pdf	vector graphics
Scalable Vector Graphics	.svg	vector graphics

These formats can be divided into bitmap and vector graphics. The difference between these two categories is described below:

Bitmap images In a bitmap image, each dot in the image has a specified color. This implies, that if you zoom in on the image there will not be enough dots, and if you zoom out there will be too many. In these cases the image viewer has to interpolate the colors to fit what is actually looked at. A bitmap image needs to have a high resolution if you want to zoom in. This format is a good choice for storing images without large shapes (e.g. dot plots). It is also appropriate if you don't have the need for resizing and editing the image after export.

Vector graphics Vector graphic is a collection of shapes. Thus what is stored is information about where a line starts and ends, and the color of the line and its width. This enables a given viewer to decide how to draw the line, no matter what the zoom factor is, thereby always giving a correct image. This format is good for graphs and reports, but less usable for dot plots. If the image is to be resized or edited, vector graphics are by far the best format to store graphics. If you open a vector graphics file in an application such as Adobe Illustrator, you will be able to manipulate the image in great detail.

Graphics files can also be imported into the **Navigation Area**. However, no kinds of graphics files can be displayed in *CLC Genomics Workbench*. See section 6.1.4 for more about importing external files into *CLC Genomics Workbench*.

6.6.3 Graphics export parameters

When you have specified the name and location to save the graphics file, you can either click **Next** or **Finish**. Clicking **Next** allows you to set further parameters for the graphics export, whereas clicking **Finish** will export using the parameters that you have set last time you made a graphics export in that file format (if it is the first time, it will use default parameters).

Parameters for bitmap formats For bitmap files, clicking **Next** will display the dialog shown in figure 6.41.

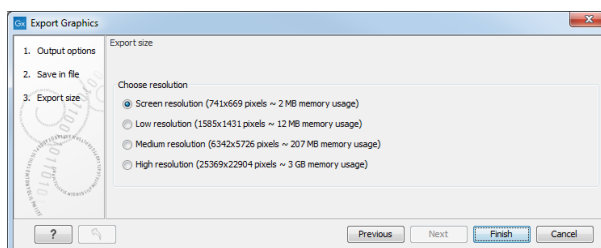

Figure 6.41: Parameters for bitmap formats: size of the graphics file.

You can adjust the size (the resolution) of the file to four standard sizes:

- Screen resolution
- Low resolution
- Medium resolution
- High resolution

The actual size in pixels is displayed in parentheses. An estimate of the memory usage for exporting the file is also shown. If the image is to be used on computer screens only, a low

resolution is sufficient. If the image is going to be used on printed material, a higher resolution is necessary to produce a good result.

Parameters for vector formats For PDF format, the dialog shown in figure 6.42 will sometimes appear after you have clicked finished (for example when the graphics use more than one page, or there is more than one PDF to export).

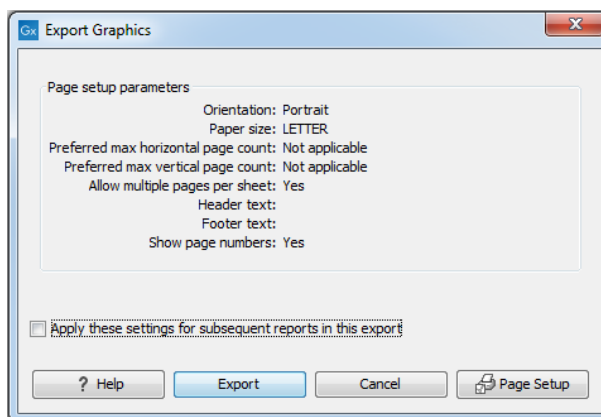

Figure 6.42: Page setup parameters for vector formats.

The settings for the page setup are shown. Clicking the **Page Setup** button will display a dialog where these settings can be adjusted. This dialog is described in section 5.2.

It is then possible to click the option "Apply these settings for subsequent reports in this export" to apply the chosen settings to all the PDFs included in the export for example.

The page setup is only available if you have selected to export the whole view - if you have chosen to export the visible area only, the graphics file will be on one page with no headers or footers.

6.6.4 Exporting protein reports

It is possible to export a protein report using the normal **Export** function (📄) which will generate a pdf file with a table of contents:

Click the report in the Navigation Area | Export (📄) in the Toolbar | select pdf

You can also choose to export a protein report using the **Export graphics** function (🖨️), but in this way you will not get the table of contents.

6.7 Export graph data points to a file

Data points for graphs displayed along the sequence or along an alignment or mapping can be exported to a semicolon-separated text file (csv format). An example of such a graph is shown in figure 6.43. This graph shows the coverage of reads in a read mapping.

To export the data points for the graph, right-click the graph and choose **Export Graph to Comma-separated File**. Depending on what kind of graph you have selected, different options will be shown: If the graph is covering a set of aligned sequences with a main sequence, such as read mappings and BLAST results, the dialog shown in figure 6.44 will be displayed. These



Figure 6.43: A graph displayed along mapped reads. Right-click the graph to export the data points to a file.

kinds of graphs are located under **Alignment info** in the Side Panel. In all other cases, a normal file dialog will be shown letting you specify name and location for the file.

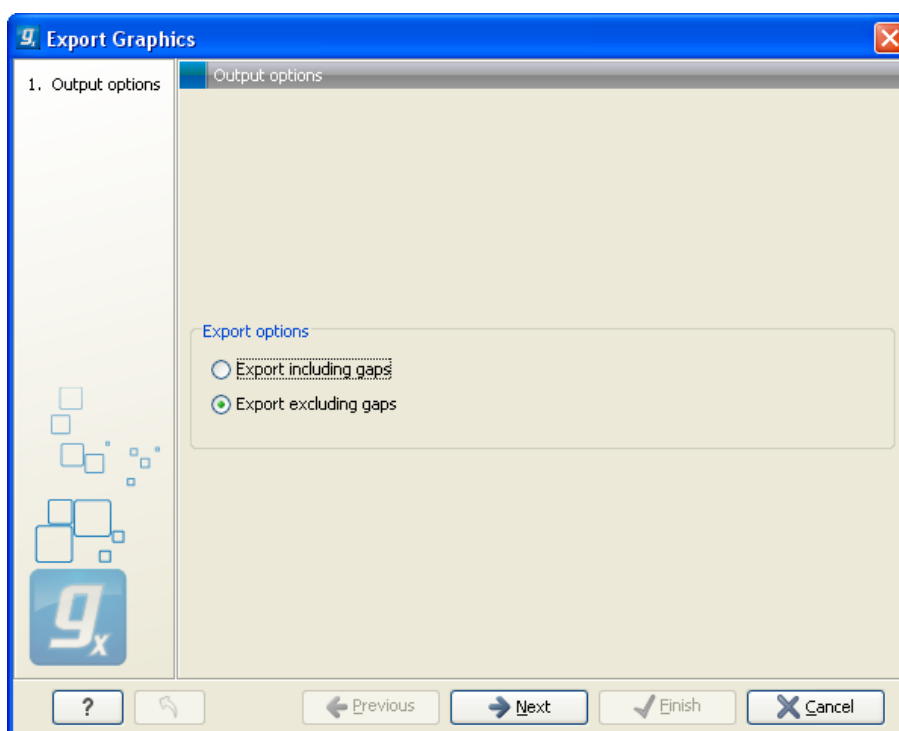

Figure 6.44: Choosing to include data points with gaps

In this dialog, select whether you wish to include positions where the main sequence (the reference sequence for read mappings and the query sequence for BLAST results) has gaps. If you are exporting e.g. coverage information from a read mapping, you would probably want to exclude gaps, if you want the positions in the exported file to match the reference (i.e. chromosome) coordinates. If you export including gaps, the data points in the file no longer corresponds to the reference coordinates, because each gap will shift the coordinates.

Clicking **Next** will present a file dialog letting you specify name and location for the file.

The output format of the file is like this:

```
"Position"; "Value";
```

```
"1"; "13";
"2"; "16";
"3"; "23";
"4"; "17";
...
```

6.8 Copy/paste view output

The content of tables, e.g. in reports, folder lists, and sequence lists can be copy/pasted into different programs, where it can be edited. *CLC Genomics Workbench* pastes the data in tabulator separated format which is useful if you use programs like Microsoft Word and Excel. There is a huge number of programs in which the copy/paste can be applied. For simplicity, we include one example of the copy/paste function from a **Folder Content** view to Microsoft Excel.

First step is to select the desired elements in the view:

click a line in the Folder Content view | hold Shift-button | press arrow down/up key

See figure 6.45.

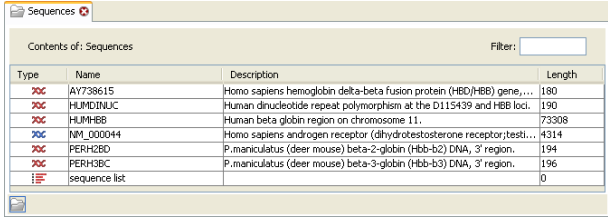

Type	Name	Description	Length
✓	AV738615	Homo sapiens hemoglobin delta-beta fusion protein (HBD/HBB) gene,...	180
✓	HUMDINJC	Human dinucleotide repeat polymorphism at the D11S439 and HBB loci.	190
✓	HUMHBB	Human beta globin region on chromosome 11.	73308
✓	NM_000044	Homo sapiens androgen receptor (dihydrotestosterone receptor; testi...	4314
✓	PERH2BD	P.maniculatus (deer mouse) beta-2-globin (Hbb-b2) DNA, 3' region.	194
✓	PERH3BC	P.maniculatus (deer mouse) beta-3-globin (Hbb-b3) DNA, 3' region.	196
	sequence list		0

Figure 6.45: Selected elements in a Folder Content view.

When the elements are selected, do the following to copy the selected elements:

right-click one of the selected elements | Edit | Copy (⌘C)

Then:

right-click in the cell A1 | Paste (⌘V)

The outcome might appear unorganized, but with a few operations the structure of the view in *CLC Genomics Workbench* can be produced. (Except the icons which are replaced by file references in Excel.)

Note that all tables can also be **Exported** (⌘E) directly in Excel format.

Chapter 7

Data download

Contents

7.1	Download reference genome data	166
7.1.1	Selecting data types for download	167
7.1.2	Cytogenetic ideograms	168
7.2	GenBank search	170
7.2.1	GenBank search options	170
7.2.2	Handling of GenBank search results	171
7.2.3	Save GenBank search parameters	173
7.3	Search for structures at NCBI	173
7.3.1	Structure search options	174
7.3.2	Handling of NCBI structure search results	174
7.3.3	Save structure search parameters	176
7.4	UniProt (Swiss-Prot/TrEMBL) search	176
7.4.1	UniProt search options	176
7.4.2	Handling of UniProt search results	178
7.4.3	Save UniProt search parameters	179
7.5	SRA search	179
7.5.1	SRA search options	180
7.5.2	SRA search output	180
7.5.3	Downloading reads and metadata from SRA	181
7.5.4	How reads are downloaded	183
7.6	Sequence web info	183

CLC Genomics Workbench offers different ways of searching and downloading online data. You must be online when initiating and performing the following searches:

7.1 Download reference genome data

The *CLC Genomics Workbench* offers an easy way of retrieving popular reference data sources such as genes, variant annotations and genome sequences as tracks. The data itself is not

provided or hosted by QIAGEN. The workbench only provides an easy way to retrieve data that should otherwise have been downloaded and imported:

Download | Download Reference Genome Data (🌐)

This opens the dialog shown in figure 7.1:

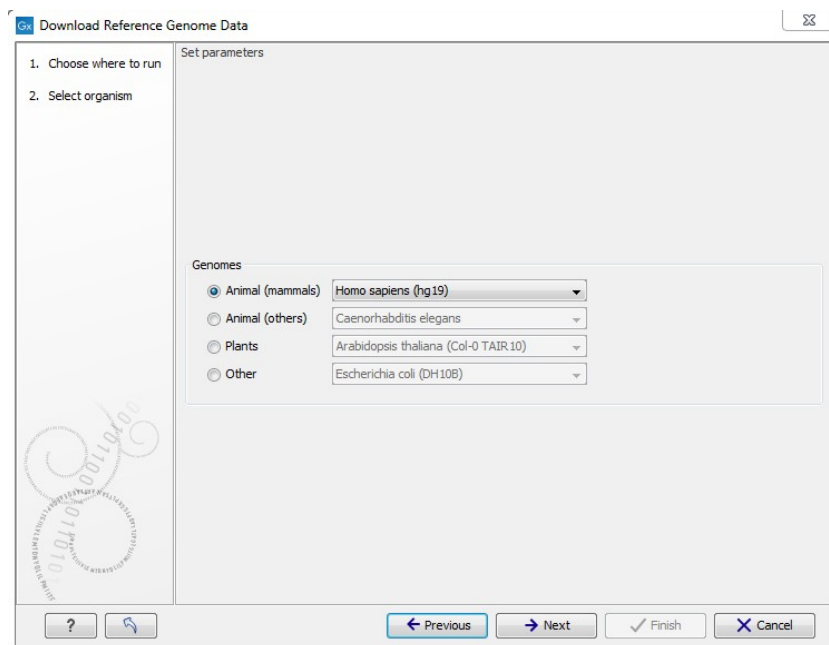

Figure 7.1: Selecting an organism for download.

Select the organism of interest and click **Next**. The list of organisms is dynamically updated by QIAGEN independently from Workbench versions, so you will always see the most recent list of organisms.

The list just shows a selection of some of the popular organisms – if you do not find what you are looking for, there is always the possibility to download and import the data as well.

7.1.1 Selecting data types for download

Once you have clicked **Next**, you will be asked whether you wish to download the genome sequence or whether you already have it available as shown in figure 7.2:

If you do not already have an existing sequence imported into the *CLC Genomics Workbench*, it will be downloaded automatically from Ensembl. If you already have a reference sequence, it has to match the genome definition built into the download tool. This means that the name and length of the chromosomes in your reference sequence have to match the genome definition of the tool.

Clicking **Next** allows you to select which types of annotation data you wish to download as shown in figure 7.3:

This step is different from organism to organism and depends on the data sources that QIAGEN has included for download. In the example in figure 7.3 showing hg19 build of the human genome, a lot of variant data is available from e.g. dbSNP. Please note that for human data, a difference between the UCSC genome build and Ensembl/NCBI exists, which means that variants

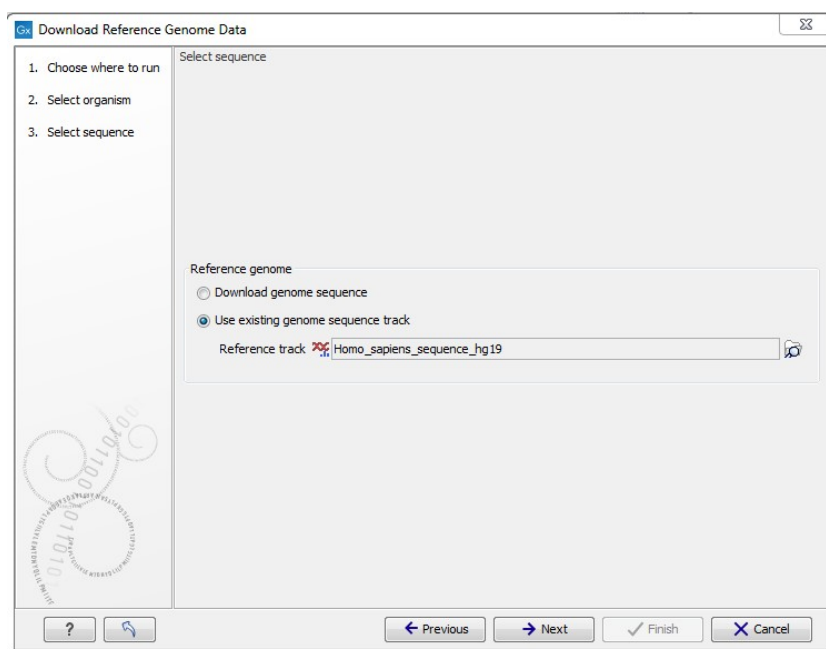

Figure 7.2: Selecting a reference genome sequence if available.

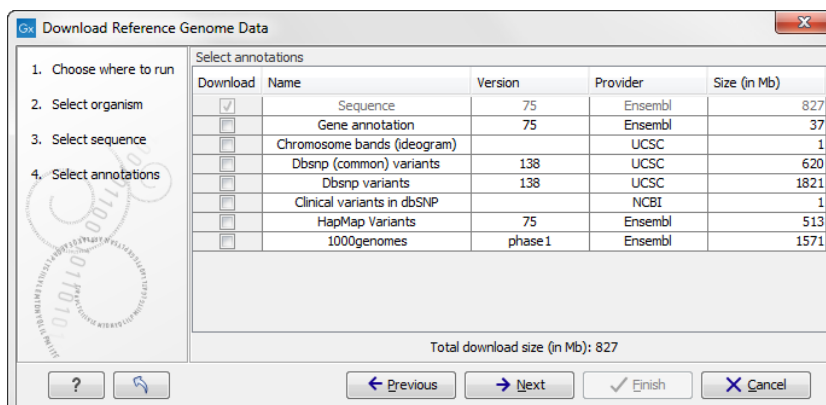

Figure 7.3: Selecting different types of annotation data for human hg19.

downloaded from UCSC will not be annotated on the mitochondrial genome when using this download tool (see <http://genome.ucsc.edu/cgi-bin/hgGateway?db=hg19>).

Both the data provider and the size of the data is listed in the dialog, and at the bottom you can see the size of all the selected downloads. Please note that the file size displayed in the setup window for the Download Genomes tool refers to the size of the compressed text files, which the tool is retrieving from the provider's depository. The size of the track objects will be, after decompression and conversion from text to the .clic track format, notably larger.

All data downloaded with this tool will be tracks (either sequence tracks or various kinds of annotation tracks). The Ensemble human gene annotation download will produce various tracks describing the chromosomal positions of features such as exons, genes, untranslated region (UTRs), transcripts, selenocysteines, coding sequences (CDSs) and mRNAs.

7.1.2 Cytogenetic ideograms

An ideogram, also called a cytogenetic ideogram, is a chromosome map with numbered banding

patterns that shows the relationship between the two chromosome arms and the centromere. Users of the UCSC Genome Browser (<http://genome.ucsc.edu/>) are most likely familiar with the use of cytogenetic ideogram in the UCSC Genome Browser. Ideograms can be imported into the Workbench (from UCSC) and be used in track lists to provide an overview of the analyzed data in context of the individual chromosomes. An example is shown in figure 7.4.



Figure 7.4: The ideogram is particularly useful when used in combination with other tracks in a track list. In this figure the ideogram is highlighted with a red box.

The ideogram can be imported into *CLC Genomics Workbench* via the download function found in the upper right corner of the Workbench.

Download | Download Reference Genome Data (🌐) | select "Chromosome bands (ideogram)"

For a description of how to do this please refer to section 7.1. The imported ideograms can be found in the **Navigation Area** at the destination that was specified in the download wizard. The ideograms are always accompanied by a reference sequence (see figure 7.5).

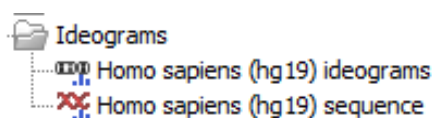

Figure 7.5: The ideograms and the reference sequence in the Navigation Area.

7.2 GenBank search

This section describes searches for sequences in GenBank - the **NCBI Entrez** database. The NCBI search view is opened in this way (figure 7.6):

Download | Search for Sequences at NCBI (🌐)

or **Ctrl + B** (⌘ + B on Mac)

This opens the following view:

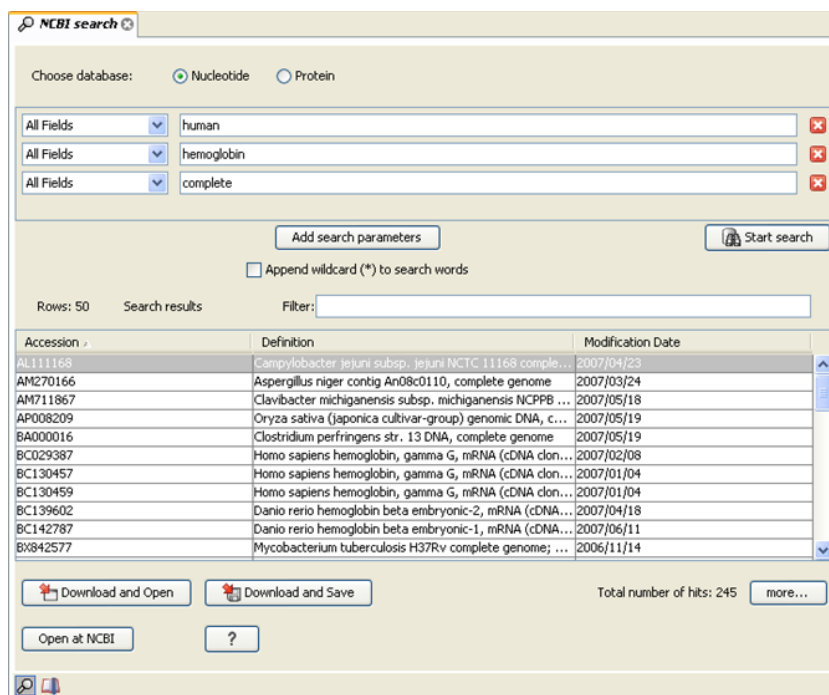

Figure 7.6: The GenBank search view.

7.2.1 GenBank search options

Conducting a search in the **NCBI Database** from *CLC Genomics Workbench* corresponds to conducting the search on NCBI's website. When conducting the search from *CLC Genomics Workbench*, the results are available and ready to work with straight away.

You can choose whether you want to search for nucleotide sequences or protein sequences.

As default, *CLC Genomics Workbench* offers one text field where the search parameters can be entered. Click **Add search parameters** to add more parameters to your search.

Note! The search is a "and" search, meaning that when adding search parameters to your search, you search for both (or all) text strings rather than "any" of the text strings.

You can append a wildcard character by checking the checkbox at the bottom. This means that you only have to enter the first part of the search text, e.g. searching for "genom" will find both "genomic" and "genome".

The following parameters can be added to the search:

- **All fields.** Text, searches in all parameters in the NCBI database at the same time.

- **Organism.** Text.
- **Description.** Text.
- **Modified Since.** Between 30 days and 10 years.
- **Gene Location.** Genomic DNA/RNA, Mitochondrion, or Chloroplast.
- **Molecule.** Genomic DNA/RNA, mRNA or rRNA.
- **Sequence Length.** Number for maximum or minimum length of the sequence.
- **Gene Name.** Text.

The search parameters are the most recently used. The **All fields** allows searches in all parameters in the NCBI database at the same time. **All fields** also provide an opportunity to restrict a search to parameters which are not listed in the dialog. E.g. writing `gene[Feature key] AND mouse` in **All fields** generates hits in the GenBank database which contains one or more genes and where 'mouse' appears somewhere in GenBank file. You can also write e.g. `CD9 NOT homo sapiens` in **All fields**.

Note! The 'Feature Key' option is only available in GenBank when searching for nucleotide sequences. For more information about how to use this syntax, see <http://www.ncbi.nlm.nih.gov/books/NBK3837/>

When you are satisfied with the parameters you have entered, click **Start search**.

Note! When conducting a search, no files are downloaded. Instead, the program produces a list of links to the files in the NCBI database. This ensures a much faster search.

7.2.2 Handling of GenBank search results

The search result is presented as a list of links to the files in the NCBI database. The **View** displays 50 hits at a time. This can be changed in the **Preferences** (see chapter 4). More hits can be displayed by clicking the **More...** button at the bottom right of the **View**.

Each sequence hit is represented by text in three columns:

- Accession.
- Description.
- Modification date.
- Length.

It is possible to exclude one or more of these columns by adjust the View preferences for the database search view. Furthermore, your changes in the View preferences can be saved. See section 4.6.

Several sequences can be selected, and by clicking the buttons in the bottom of the search view, you can do the following:

- Download and open, doesn't save the sequence.

- Download and save, lets you choose location for saving sequence.
- Open at NCBI, searches the sequence at NCBI's web page.

Double-clicking a hit will download and open the sequence. The hits can also be copied into the **View Area** or the **Navigation Area** from the search results by drag and drop, copy/paste or by using the right-click menu as described below.

Drag and drop from GenBank search results

The sequences from the search results can be opened by dragging them into a position in the **View Area**.

Note! A sequence is not saved until the **View** displaying the sequence is closed. When that happens, a dialog opens: Save changes of sequence x? (Yes or No).

The sequence can also be saved by dragging it into the **Navigation Area**. It is possible to select more sequences and drag all of them into the **Navigation Area** at the same time.

Download GenBank search results using right-click menu

You may also select one or more sequences from the list and download using the right-click menu (see figure 7.7). Choosing **Download and Save** lets you select a folder where the sequences are saved when they are downloaded. Choosing **Download and Open** opens a new view for each of the selected sequences.

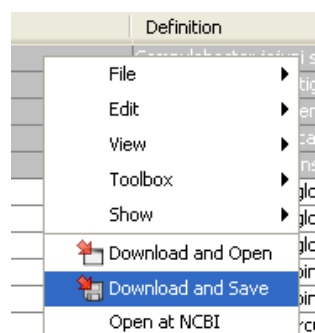

Figure 7.7: By right-clicking a search result, it is possible to choose how to handle the relevant sequence.

Copy/paste from GenBank search results

When using copy/paste to bring the search results into the **Navigation Area**, the actual files are downloaded from GenBank.

To copy/paste files into the **Navigation Area**:

select one or more of the search results | Ctrl + C (⌘ + C on Mac) | select a folder in the Navigation Area | Ctrl + V

Note! Search results are downloaded before they are saved. Downloading and saving several files may take some time. However, since the process runs in the background (displayed in the

Status bar) it is possible to continue other tasks in the program. Like the search process, the download process can be stopped. This is done in the **Toolbox** in the **Processes** tab.

7.2.3 Save GenBank search parameters

The search view can be saved either using dragging the search tab and dropping it in the **Navigation Area** or by clicking **Save** (↵). When saving the search, only the parameters are saved - not the results of the search. This is useful if you have a special search that you perform from time to time.

Even if you don't save the search, the next time you open the search view, it will remember the parameters from the last time you did a search.

7.3 Search for structures at NCBI

This section describes searches for three dimensional structures from the NCBI structure database <http://www.ncbi.nlm.nih.gov/Structure/MMDB/mmdb.shtml>. For manipulating and visualization of the downloaded structures see section 12.2.

The NCBI search view is opened in this way:

Download | Search for PBD Structures at NCBI (🌐)

or **Ctrl + B** (⌘ + B on Mac)

This opens the view shown in figure 7.8:

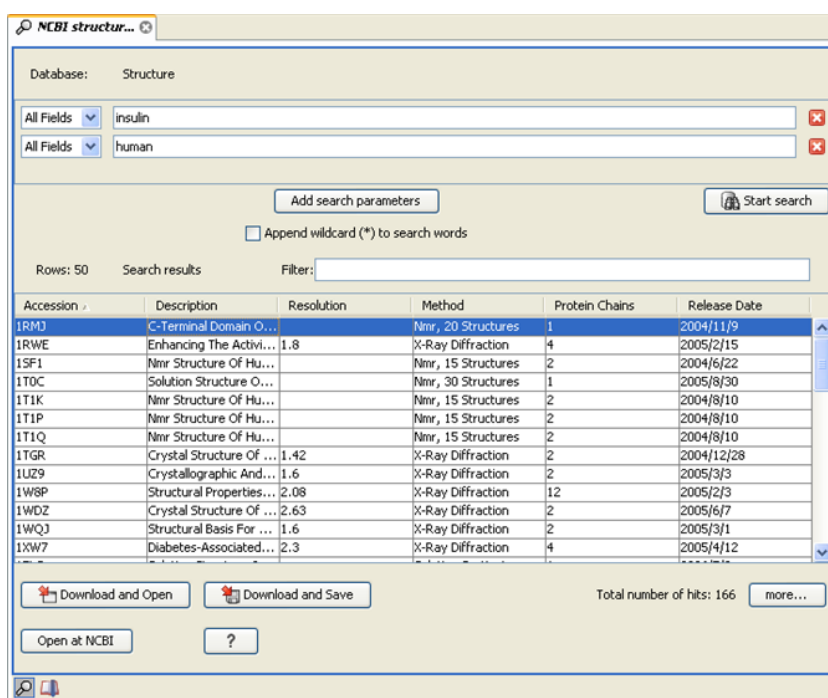

Figure 7.8: The structure search view.

7.3.1 Structure search options

Conducting a search in the **NCBI Database** from *CLC Genomics Workbench* corresponds to conducting search for structures on the NCBI's Entrez website. When conducting the search from *CLC Genomics Workbench*, the results are available and ready to work with straight away.

As default, *CLC Genomics Workbench* offers one text field where the search parameters can be entered. Click **Add search parameters** to add more parameters to your search.

Note! The search is a "AND" search, meaning that when adding search parameters to your search, you search for both (or all) text strings rather than "any" of the text strings.

You can append a wildcard character by clicking the checkbox at the bottom. This means that you only have to enter the first part of the search text, e.g. searching for "prot" will find both "protein" and "protease".

The following parameters can be added to the search:

- **All fields.** Text, searches in all parameters in the NCBI structure database at the same time.
- **Organism.** Text.
- **Author.** Text.
- **PdbAcc.** The accession number of the structure in the PDB database.

The search parameters are the most recently used. The **All fields** allows searches in all parameters in the database at the same time.

All fields also provide an opportunity to restrict a search to parameters which are not listed in the dialog. E.g. writing 'gene[Feature key] AND mouse' in **All fields** generates hits in the GenBank database which contains one or more genes and where 'mouse' appears somewhere in GenBank file. NB: the 'Feature Key' option is only available in GenBank when searching for nucleotide structures. For more information about how to use this syntax, see http://www.ncbi.nlm.nih.gov/entrez/query/static/help/Summary_Matrices.html#Search_Fields_and_Qualifiers

When you are satisfied with the parameters you have entered click **Start search**.

Note! When conducting a search, no files are downloaded. Instead, the program produces a list of links to the files in the NCBI database. This ensures a much faster search.

7.3.2 Handling of NCBI structure search results

The search result is presented as a list of links to the files in the NCBI database. The **View** displays 50 hits at a time (can be changed in the **Preferences** (see chapter 4)). More hits can be displayed by clicking the **More...** button at the bottom right of the **View**.

Each structure hit is represented by text in three columns:

- Accession.

- Description.
- Resolution.
- Method.
- Protein chains
- Release date.

It is possible to exclude one or more of these columns by adjust the View preferences for the database search view. Furthermore, your changes in the View preferences can be saved. See section 4.6.

Several structures can be selected, and by clicking the buttons in the bottom of the search view, you can do the following:

- **Download and open.** Download and open immediately.
- **Download and save.** Download and save lets you choose location for saving structure.
- **Open at NCBI.** Open additional information on the selected structure at NCBI's web page.

Double-clicking a hit will download and open the structure. The hits can also be copied into the **View Area** or the **Navigation Area** from the search results by drag and drop, copy/paste or by using the right-click menu as described below.

Drag and drop from structure search results

The structures from the search results can be opened by dragging them into a position in the **View Area**.

Note! A structure is not saved until the **View** displaying the structure is closed. When that happens, a dialog opens: Save changes of structure x? (Yes or No).

The structure can also be saved by dragging it into the **Navigation Area**. It is possible to select more structures and drag all of them into the **Navigation Area** at the same time.

Download structure search results using right-click menu

You may also select one or more structures from the list and download using the right-click menu (see figure 7.9). Choosing **Download and Save** lets you select a folder or location where the structures are saved when they are downloaded. Choosing **Download and Open** opens a new view for each of the selected structures.

The selected structures are not downloaded from the NCBI website but is downloaded from the RCSB Protein Data Bank <http://www.rcsb.org/pdb/home/home.do> in PDB format.

Copy/paste from structure search results

When using copy/paste to bring the search results into the **Navigation Area**, the actual files are downloaded.

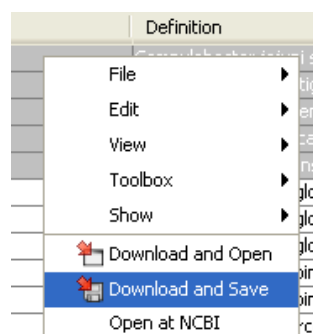

Figure 7.9: By right-clicking a search result, it is possible to choose how to handle the relevant structure.

To copy/paste files into the **Navigation Area**:

select one or more of the search results | **Ctrl + C** (⌘ + C on Mac) | **select location or folder in the Navigation Area** | **Ctrl + V**

Note! Search results are downloaded before they are saved. Downloading and saving several files may take some time. However, since the process runs in the background (displayed in the **Status bar**) it is possible to continue other tasks in the program. Like the search process, the download process can be stopped. This is done in the **Toolbox** in the **Processes** tab.

7.3.3 Save structure search parameters

The search view can be saved either using dragging the search tab and dropping it in the **Navigation Area** or by clicking **Save** (📁). When saving the search, only the parameters are saved - not the results of the search. This is useful if you have a special search that you perform from time to time.

Even if you don't save the search, the next time you open the search view, it will remember the parameters from the last time you did a search.

7.4 UniProt (Swiss-Prot/TrEMBL) search

This section describes searches in UniProt and the handling of search results. UniProt is a global database of protein sequences.

The UniProt search view (figure 7.10) is opened in this way:

Download | **Search for Sequences in UniProt** (🔍)

7.4.1 UniProt search options

Conducting a search in **UniProt** from *CLC Genomics Workbench* corresponds to conducting the search on UniProt's website. When conducting the search from *CLC Genomics Workbench*, the results are available and ready to work with straight away.

Above the search fields, you can choose which database to search:

- **Swiss-Prot** This is believed to be the most accurate and best quality protein database available. All entries in the database has been curated manually and data are entered

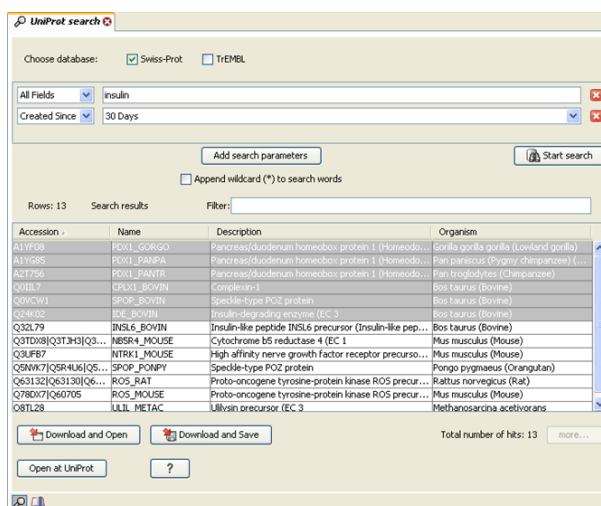

Figure 7.10: The UniProt search view.

according to the original research paper.

- **TrEMBL** This database contain computer annotated protein sequences, thus the quality of the annotations is not as good as the Swiss-Prot database.

As default, *CLC Genomics Workbench* offers one text field where the search parameters can be entered. Click **Add search parameters** to add more parameters to your search.

Note! The search is a "and" search, meaning that when adding search parameters to your search, you search for both (or all) text strings rather than "any" of the text strings.

You can append a wildcard character by checking the checkbox at the bottom. This means that you only have to enter the first part of the search text, e.g. searching for "genom" will find both "genomic" and "genome".

The following parameters can be added to the search:

- **All fields.** Text, searches in all parameters in the UniProt database at the same time.
- **Organism.** Text.
- **Description.** Text.
- **Created Since.** Between 30 days and 10 years.
- **Feature.** Text.

The search parameters listed in the dialog are the most recently used. The **All fields** allows searches in all parameters in the UniProt database at the same time.

When you are satisfied with the parameters you have entered, click **Start search**.

Note! When conducting a search, no files are downloaded. Instead, the program produces a list of links to the files in the UniProt database. This ensures a much faster search.

7.4.2 Handling of UniProt search results

The search result is presented as a list of links to the files in the UniProt database. The **View** displays 50 hits at a time (can be changed in the **Preferences** (see chapter 4). More hits can be displayed by clicking the **More...** button at the bottom right of the **View**. More hits can be displayed by clicking the **More...** button at the bottom left of the **View**.

Each sequence hit is represented by text in three columns:

- Accession
- Name
- Description
- Organism
- Length.

It is possible to exclude one or more of these columns by adjust the View preferences for the database search view. Furthermore, your changes in the View preferences can be saved. See section 4.6.

Several sequences can be selected, and by clicking the buttons in the bottom of the search view, you can do the following:

- Download and open, does not save the sequence.
- Download and save, lets you choose location for saving sequence.
- Open at UniProt, searches the sequence at UniProt's web page.

Double-clicking a hit will download and open the sequence. The hits can also be copied into the **View Area** or the **Navigation Area** from the search results by drag and drop, copy/paste or by using the right-click menu as described below.

Drag and drop from UniProt search results

The sequences from the search results can be opened by dragging them into a position in the **View Area**.

Note! A sequence is not saved until the **View** displaying the sequence is closed. When that happens, a dialog opens: Save changes of sequence x? (Yes or No).

The sequence can also be saved by dragging it into the **Navigation Area**. It is possible to select more sequences and drag all of them into the **Navigation Area** at the same time.

Download UniProt search results using right-click menu

You may also select one or more sequences from the list and download using the right-click menu (see figure 7.7). Choosing **Download and Save** lets you select a folder or location where the sequences are saved when they are downloaded. Choosing **Download and Open** opens a new view for each of the selected sequences.

Copy/paste from UniProt search results

When using copy/paste to bring the search results into the **Navigation Area**, the actual files are downloaded from UniProt.

To copy/paste files into the **Navigation Area**:

select one or more of the search results | Ctrl + C (⌘ + C on Mac) | select location or folder in the Navigation Area | Ctrl + V

Note! Search results are downloaded before they are saved. Downloading and saving several files may take some time. However, since the process runs in the background (displayed in the **Toolbox** under the **Processes** tab) it is possible to continue other tasks in the program. Like the search process, the download process can be stopped, paused, and resumed.

7.4.3 Save UniProt search parameters

The search view can be saved either using dragging the search tab and dropping it in the **Navigation Area** or by clicking **Save** (↵). When saving the search, only the parameters are saved - not the results of the search. This is useful if you have a special search that you perform from time to time.

Even if you don't save the search, the next time you open the search view, it will remember the parameters from the last time you did a search.

7.5 SRA search

This section describes searches in SRA and the handling of search results. SRA is an NCBI maintained database of NGS data.

The SRA search view (figure 7.11) is opened in this way:

Download | Search for Reads in SRA (🇺🇸)

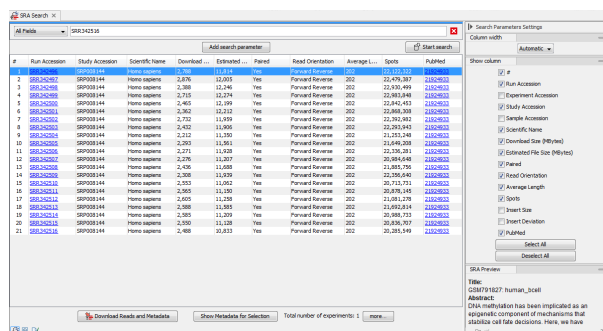

Figure 7.11: The SRA search view.

The tool queries the database with SRA accession number (see in figure 7.11) or various entries such as "hindgut" or "genometrakr". It is also possible to look for entries with certain properties, and to form more refined queries such as "paired-end RNA-Seq data from an Illumina HiSeq2500".

7.5.1 SRA search options

Search parameters Different types of search are available from a drop-down menu on the left hand side of the search bar.

Some special types are:

- **Modification/Publication date** This allows the narrowing of results to a particular range of dates specified as [MM] [YYYY]. For example 08 2016 to 08 2016 returns results published from the first day in August 2016 to the last day in August 2016.
- **Strategy** Provides an additional drop-down list of types of experiments e.g., RNA-Seq, ChIP-Seq, etc.
- **Library Selection** Provides an additional drop-down list of known library preparation methods, e.g. Poly(A) and Size fractionation.
- **Platform** Provides an additional drop-down list of NGS sequencing platforms e.g., Illumina, Ion Torrent. Note that download of data from some platforms such as Complete Genomics is not supported.
- **Instrument** Provides an additional drop-down list of individual NGS sequencing machines e.g., HiSeq X Ten, Ion Torrent PGM.
- **Paired Status** Choose between paired end and single end runs.
- **Availability** Choose between dbGaP or public. dbGaP refers to confidential data that can be searched through the tool and accessed upon request at NCBI.
- **PubMed** Choose between "has abstract" or "has full-text article" to find results that have a PubMed abstract or entire publication available.

Any number of search parameters may be added to refine a search, for example to construct a query for "paired-end RNA-Seq data from an Illumina HiSeq2500", but the return search must satisfy every search parameter. In other words, search parameters work as "A and B" and not as "A or B". In consequence, searches performed with two platform parameters for example "Platform = Illumina and Platform = Ion Torrent" will not return any results.

Note also that searches rely on metadata provided by the depositor of the SRA runs. This means that if, for example, an RNA-Seq run was not annotated as being RNA-Seq during submission, it won't be returned by a search for "Strategy = RNA-Seq".

Finally, the search tool uses NCBI's e-utilities, which occasionally experience downtime. If no searches return any results, check <https://www.ncbi.nlm.nih.gov/sra/> to see the status of the service.

7.5.2 SRA search output

The search results are displayed with one run per line. Each Run Accession is a hyperlink to the NCBI webpage for the run, where additional information may be found, such as the distribution of nucleotide quality scores and links to external resources. On the right hand side of the search table, a "SRA Preview" panel shows the title and abstract associated to the selected run when available.

When looking for a specific run using the run SRA accession number, the tool will output the run that was searched and may also list additional runs that were submitted as part of the same experiment. In any case, it is safest to perform a new search specifically for the study to make sure the tool retrieves all possible runs. Right-click on a row to get a list of possible searches based on the selected run (figure 7.12), for example searching for more runs from the same sample, experiment or organism.

By default, the tool will output a maximum of 50 runs. The "more..." button below the table retrieves additional search results when the search exceeds 50 runs. The number of additional results returned can be controlled in Edit | Preferences | General | Number of hits (NCBI/Uniprot).

The "Total number of experiments" at the bottom of the search table reports how many experiments were retrieved, and not how many runs are listed in the table.

#	Run Accession	Study Accession	Scientific Name	Download	Estimated	Paired	Read Orientation	Average L.	Size	PubMed
28	SRR1020822	SRR1020822	gut metagenome	22	68	Yes	Unknown	245	28,282	
29	SRR1020826	SRR1020826	gut metagenome	21	67	Yes	Unknown	247	26,148	
30	SRR1020827	SRR1020827	gut metagenome	21	71	Yes	Unknown	242	41,589	
31	SRR1020828	SRR1020828	gut metagenome	24	77	Yes	Unknown	241	66,363	
32	SRR1020831	SRR1020831	gut metagenome	24	75	Yes	Unknown	245	64,914	
33	SRR1020834	SRR1020834	gut metagenome	20	62	Yes	Unknown	241	53,263	
34	SRR1020835	SRR1020835	gut metagenome	20	62	Yes	Unknown	245	70,688	
35	SRR1020836	SRR1020836	gut metagenome	20	62	Yes	Unknown	245	51,590	
36	SRR1020837	SRR1020837	gut metagenome	20	62	Yes	Unknown	245	46,466	
37	SRR1020838	SRR1020838	gut metagenome	20	62	Yes	Unknown	245	25,107	
38	SRR1020839	SRR1020839	gut metagenome	20	62	Yes	Unknown	244	53,623	
39	SRR1020840	SRR1020840	gut metagenome	20	62	Yes	Unknown	244	76,287	
40	SRR1020841	SRR1020841	gut metagenome	20	62	Yes	Unknown	244	51,102	
41	SRR1020842	SRR1020842	gut metagenome	20	62	Yes	Unknown	244	52,046	
42	SRR1020843	SRR1020843	gut metagenome	20	62	Yes	Unknown	244	52,046	
43	SRR1020844	SRR1020844	gut metagenome	20	62	Yes	Unknown	244	52,046	
44	SRR1020845	SRR1020845	gut metagenome	20	62	Yes	Unknown	244	52,046	
45	SRR1020846	SRR1020846	gut metagenome	20	62	Yes	Unknown	244	52,046	
46	SRR1020847	SRR1020847	gut metagenome	20	62	Yes	Unknown	244	52,046	
47	SRR1020848	SRR1020848	gut metagenome	20	62	Yes	Unknown	244	52,046	
48	SRR1020849	SRR1020849	gut metagenome	20	62	Yes	Unknown	244	52,046	
49	SRR1020850	SRR1020850	gut metagenome	20	62	Yes	Unknown	244	52,046	
50	SRR1020851	SRR1020851	gut metagenome	20	62	Yes	Unknown	244	52,046	

Figure 7.12: The SRA search result table.

At the bottom of the table, the button **"Show Metadata for Selection"** will create a metadata table containing sample specific information for the selected run(s). The first columns of the metadata table contain the same database identifiers as in the Search Table. The last columns recover sample details associated with the biosample. The list of all metadata available for the selected run is located in the right hand side panel of the table. This functionality is especially useful when selecting external data for use in a meta-analysis. For example, if your analysis is for a particular cancer type, and controls for patient age and gender, the **"Show Metadata for Selection"** facilitates the search for other datasets where the same metadata is available.

7.5.3 Downloading reads and metadata from SRA

Click on **Download Reads and Metadata** to save reads and their associated data. The data is saved in a metadata table and can be later associated to the reads for use in downstream analysis, for example to define factors for differential expression in the Differential Expression for RNA-Seq tool. Should the metadata table later be deleted, the "Show Metadata for Selection" button can be used to quickly recover a copy without having to re-download all the runs.

The Download Reads and Metadata wizard offers the following options:

Import Options (figure 7.13)

As with other NGS reads importers, it is possible to discard read names and/or quality scores to save space.

- "Download size" is the size of the .sra files that will be downloaded. Note that in some cases, the actual download may be up to 1GB larger than stated, as .sra files can be

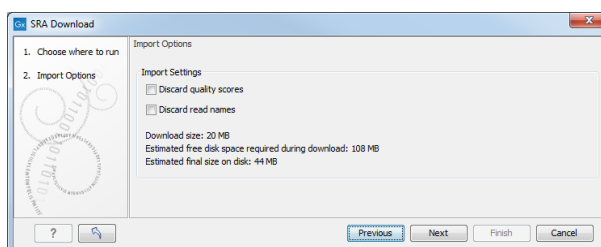

Figure 7.13: The Download Reads and Metadata Import Options dialog.

reference-compressed, meaning that a copy of the genome must also be retrieved before the file can be converted into fastq and imported into the workbench.

- "Estimated free disk space required during download" is a conservative estimate for the total free disk space required to download the selected runs. This is the "Estimated final size on disk" + the size of the largest single run in FASTQ format + the size of the largest single run in SRA format.
- "Estimated final size on disk" is an estimate of the total size of the files after they have been imported into the workbench.

Edit Paired End Settings (figure 7.14)

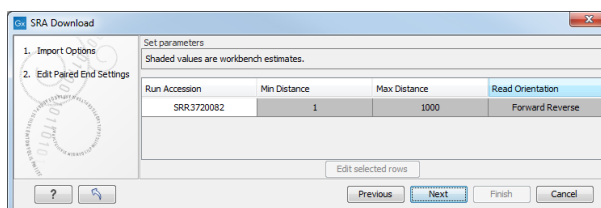

Figure 7.14: The Download Reads and Metadata Edit Paired End Settings dialog.

This dialog appears for all runs marked as being Paired (Paired column contains "Yes").

Read orientation is always guessed to be "Forward Reverse" unless otherwise stated.

Minimum distance and **Maximum distance** depend on how much data the depositor supplied with the runs. They are allowed to supply an "Insert Size" and an "Insert Deviation".

- If no insert size is supplied, we use defaults of 1 for minimum and 1,000 for maximum.
- If an insert size is supplied, we make the following calculation:
 - $Min\ distance = insert\ size - 5 * insert\ deviation$
 - $Max\ distance = insert\ size + 5 * insert\ deviation$
- If no deviation is supplied, we estimate this to be $0.1 * insert\ size$ and perform the same calculation as above.

When possible, we generally recommend that SRA data be used in subsequent analyses with the "Auto paired end distance detection" option enabled as the quality of deposited information is low. For example, some depositors report insert size including the length of the reads, and some excluding the length of the reads.

7.5.4 How reads are downloaded

SRA reads are downloaded in the ".sra" format using the NCBI SRA-toolkit. A .sra file is typically 2.5x smaller than an equivalent zipped fastq file. Download uses the NCBI 'prefetch' utility, and the resulting file is read into the workbench using 'fastq-dump'.

Sometimes runs in SRA cannot be downloaded. The affected runs are listed in a Problems panel together with a description of the problem. It is still possible to download the remaining runs.

The most common problems are:

- "The selected SRA reads contain no spots, and cannot be imported in the workbench.": The run has no associated sequencing data.
- "The selected SRA reads are dbGaP restricted.": For data protection reasons, you must request access to these reads. Requests and download cannot happen within the workbench, but you can follow the procedures here: <http://www.ncbi.nlm.nih.gov/books/NBK5295/>.
- "The selected SRA reads are made with an unsupported sequencing platform.": For example, Complete Genomics reads consist of eight regions separated by gaps of variable lengths, and should be analyzed by specialist tools.

We support download of reads via the commercial FASP protocol from Aspera. In our testing, Aspera download is up to 10x faster than a normal http download.

To enable this functionality, you have to download the Aspera Connect software from <http://downloads.asperasoft.com/connect2/>.

On Windows, choose to do a "Custom" install and choose to "Install for all users of this machine". You can then test if the installation worked by downloading a small file. The log (accessible from the Processes tab) will include the line "Downloading via fasp" if everything worked.

It is possible to change the Aspera options using **Preferences | Advanced | SRA Download**.

The following options are available:

- **Use Aspera when available** Per default, Aspera is automatically used if installed. This option makes it possible to disable Aspera.
- **Limit Aspera download speeds to [] Mb/s (Mac and Linux only)** Using Aspera may take up a lot of network resources. Use this option to specify a maximum download speed (in megabit per second). Note that this option is only available on Mac and Linux. For Windows users, it is possible to limit the maximum download speed by modifying the `aspera.conf` file, which can be found in `C:\Program Files (x86)\Aspera\Aspera Connect`. See <http://download.asperasoft.com/download/docs/csrv/3.3.4/linux/html/index.html> and <http://download.asperasoft.com/download/docs/csrv/3.3.4/linux/html/fasp/setting-global-bandwidth.html> for more details.

7.6 Sequence web info

CLC Genomics Workbench provides direct access to web-based search in various databases and on the Internet using your computer's default browser. You can look up a sequence in

the databases of NCBI and UniProt, search for a sequence on the Internet using Google and search for Pubmed references at NCBI. This is useful for quickly obtaining updated and additional information about a sequence.

The functionality of these search functions depends on the information that the sequence contains. You can see this information by viewing the sequence as text (see section 10.5). In the following sections, we will explain this in further detail.

The procedure for searching is identical for all four search options (see also figure 7.15):

Open a sequence or a sequence list | Right-click the name of the sequence | Web Info (🌐) | select the desired search function

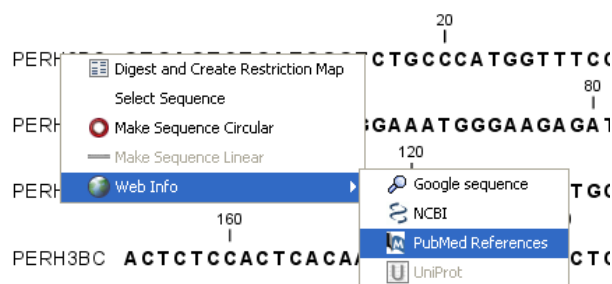

Figure 7.15: Open webpages with information about this sequence.

This will open your computer's default browser searching for the sequence that you selected.

Google sequence The Google search function uses the accession number of the sequence which is used as search term on <http://www.google.com>. The resulting web page is equivalent to typing the accession number of the sequence into the search field on <http://www.google.com>.

NCBI The NCBI search function searches in GenBank at NCBI (<http://www.ncbi.nlm.nih.gov>) using an identification number (when you view the sequence as text it is the "GI" number). Therefore, the sequence file must contain this number in order to look it up at NCBI. All sequences downloaded from NCBI have this number.

PubMed References The PubMed references search option lets you look up Pubmed articles based on references contained in the sequence file (when you view the sequence as text it contains a number of "PUBMED" lines). Not all sequence have these PubMed references, but in this case you will see a dialog and the browser will not open.

UniProt The UniProt search function searches in the UniProt database (<http://www.ebi.uniprot.org>) using the accession number. Furthermore, it checks whether the sequence was indeed downloaded from UniProt.

Additional annotation information When sequences are downloaded from GenBank they often link to additional information on taxonomy, conserved domains etc. If such information is available for a sequence it is possible to access additional accurate online information. If the

db_xref identifier line is found as part of the annotation information in the downloaded GenBank file, it is possible to easily look up additional information on the NCBI web-site.

To access this feature, simply right click an annotation and see which databases are available. For tracks, these links are also available in the track table.

Chapter 8

Running tools, handling results and batching

Contents

8.1	Running tools	186
8.2	Handling results	188
8.3	Batch processing	189
8.3.1	Standard batch processing	189
8.3.2	Batch overview	190
8.3.3	Parameters for batch runs	191
8.3.4	Running the analysis and organizing the results	191
8.3.5	Batch launching workflows with multiple inputs	192

This section describes how to run a tool using singles files as input, as well as how to handle and inspect results. We also review how to run tools using the batch mode when the option is enabled.

8.1 Running tools

All the analyses in the **Toolbox** are performed in a step-by-step procedure:

- Data elements to be used in the analysis are selected.
- Any configurations necessary for the tool to run are made.
- The results are opened or saved.

You can open a tool from the Toolbox by double clicking on its name in the Toolbox. In case you do not know which folder the tool you are looking for belongs to, you can use the very useful Launch button () and type any part of the tool name in the search field. Double click on the name of the tool in the table.

When you open a tool, a wizard pop up in the center of the View Area. Through a succession of windows you will enter the data you want to analyze, the parameters of the analysis you want

to perform and how you want to handle the results of the analysis. You can navigate between windows by clicking the buttons **Next** and **Previous** at the bottom of the window.

If you are working on a network and have access to a server, you will first be asked to "Choose where to run" the tool. This window gives the following options:

- **Workbench** to run the tool on your own computer.
- **CLC Server** to run the tool on a server.
- **Grid** to be able to choose from the drop down menu.

If you check the option "Remember setting and skip this step", you will not have to enter the information described above for this particular tool. The setting can always be changed xxx

After having decided where to run the tool, the next window of the wizard is usually asking you to select the input file(s). This window displays on the left a replicate of your Navigation Area in which only the files that have a format adapted to the tool will be shown. The specific input file formats required by a tool are described for each tool independently in the relevant sections of the manual that you can access easily by clicking on the **Help** button (?). For example, you can see a view of the Navigation Area in the workbench and the same Navigation Area in the wizard in figure 8.1. The Assemble Sequences tool will only accept nucleotide sequences (as such or part of a list), which explains why the file called "Read mapping", or the amino acid sequence ATP8a1 are not being displayed in the wizard Navigation Area.

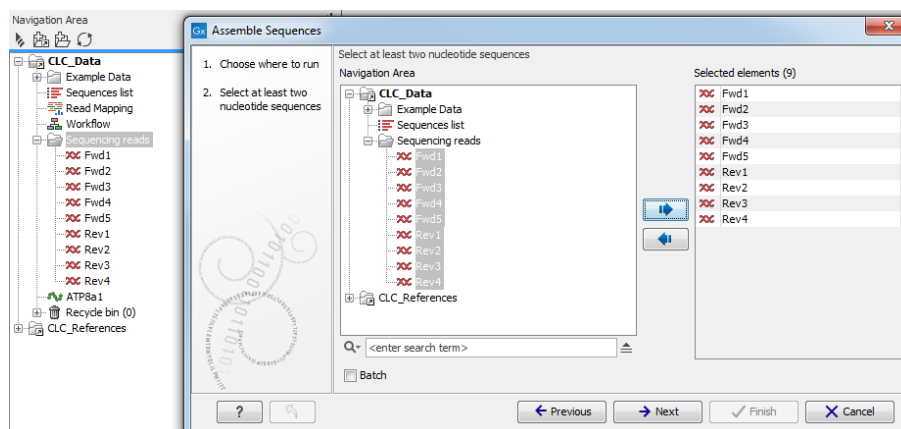

Figure 8.1: You can select input files for the tool from the Navigation Area replicate on the left hand side of the wizard window.

To select a file, you need to move it from the "Navigation Area" view to the "Selected elements" view. You can move a file by clicking on the arrows between the 2 views, or by double click on the file itself. Sometimes, having a file selected in the workbench Navigation Area will automatically put it in the Selected elements view. If you do not wish to work with this file as input, make sure to deselect it. You can deselect by using the arrow to send it out the selected elements view, or again by double clicking on it.

You also have the option in this window to work in batch, which means that the tool will run multiple times using each selected file as an independent dataset (as opposed to treat all selected files as a single input). To learn more about working in batch, please see section 8.3.

Once all elements are selected, you can click **Next** to proceed to the next step(s) of the wizard. During these steps you are usually required to set parameters for the tool (see figure 8.2 for

an example). You can read about specific settings for each tool in the relevant section of the manual accessible directly using the **Help** button (?). A pop up window will open to the section of the manual describing the tool you are using. The **Restore Settings** button (≡) will reset all parameters from the pop window to their default values.

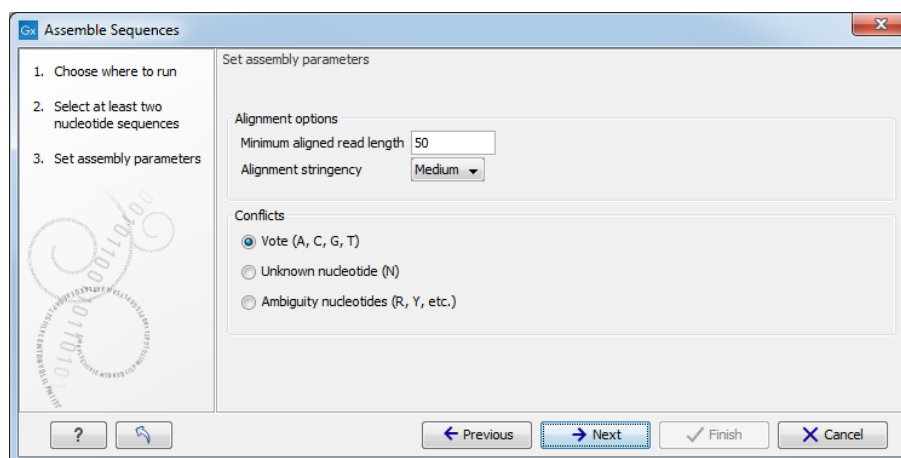

Figure 8.2: An example of a "Set parameters" window.

8.2 Handling results

A tool will output one or more result files, some of which are optional and can be selected - or deselected - in the last wizard window called "Result handling". The kind of output files generated by a tool as well as a description of additional files are described in the tool specific sections of the manual.

The "result handling" window also allows you to decide whether you want to open or save your results.

- **Open.** This will open the result of the analysis in a view. This is the default setting.
- **Save** The results will be saved rather than opened. You will be prompted for where you wish the results to be saved (figure 8.3). You can save to an existing area or create a new folder to save the results into.

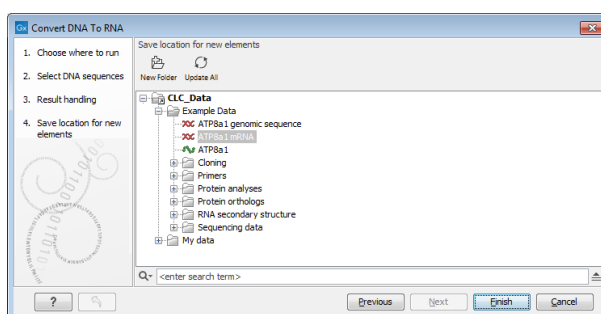

Figure 8.3: Specify where to save the results of an analysis.

You may also have the option to "Open log". A log is a textual view of the progress of the job.

Click on the button labeled **Finish** to start the tool.

If you chose "Open" results, they will open automatically open one or several Views in the View Area. Each View is described by a file name appended with an asterisk to indicate that this View has not been saved yet. To save it, drag the View tab to the relevant location in the Navigation Area, or simply use the usual Ctrl + S (or ⌘ + S). You can also right click on the tab and choose "Save" or use the "Save" button above the Navigation Area.

If you chose "Save" results, they will not open automatically, but they saved in the location you can specify in an extra wizard window. You can open the results by finding the file name in the Navigation Area after the tool is done processing, or by using the little arrow to the right of the analysis name in the Processes tab and choosing the option "Show results"(see figure 8.4).

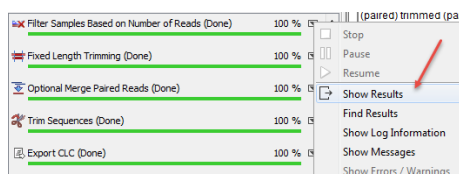

Figure 8.4: Find your results using the little arrow to the right of the analysis name in the Processes tab.

8.3 Batch processing

Batch processing refers to running an analysis multiple times, using different inputs for each analysis run. For example, if you have 10 sequence lists and wish to run 10 mapping analyses, one per sequence list, then these 10 analyses could be launched by setting up one batch job. When a job is run in batch mode, parameter settings stay the same for each run. It is just the inputs that are changed.

This section describes batch processing as it applies to most workbench tools and to workflows with a single input element.

Batching installed workflows with multiple input elements, where **all** input elements will be changed per batch, is done differently (see section 8.3.5).

8.3.1 Standard batch processing

Standard batch mode is activated by clicking the **Batch** checkbox in the dialog where the input data is selected (figure 8.5).

Unlike launching a single task, you can select a folder as well as, or instead of, individual data elements for the analysis.

Identifying batch units A batch unit is the set of data that will be used as a single input set for a given run of an analysis. A given batch unit can consist of one or more data elements.

If a folder is selected as input to a batch analysis, each folder or data element directly under that folder will be considered a batch unit. This means:

- Each individual data element contained directly within the folder is a batch unit.
- Each subfolder directly within this folder is a batch unit, so all elements within a given subfolder will be considered as single input for the purposes of the analysis.

- Elements in any more deeply nested subfolders (e.g. subfolders of subfolders of the originally selected folder) will not be considered for the analysis.

An example of a batch run is shown in figure 8.5.

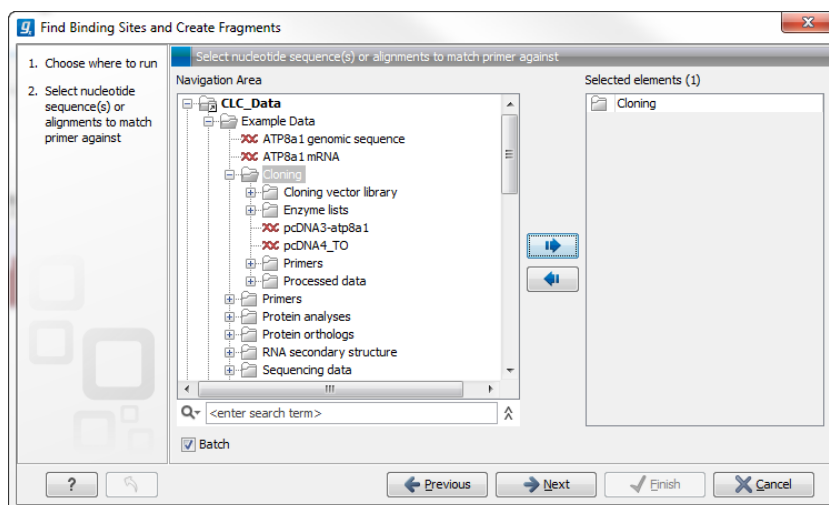

Figure 8.5: The Cloning folder includes both folders and sequences.

8.3.2 Batch overview

The next Wizard step is the batch overview where you have the opportunity to refine the list of data that will be in each batch unit. For example, you could use this step to ensure that only trimmed sequence lists and not all sequence lists, should be used for the analysis that is being setup.

The `Cloning` folder that is found in the example data (see section 1.5.2) contains two sequences (~~xxx~~) and four folders (📁). If the `Batch` checkbox is checked and the `Cloning` folder is selected for an analysis, then after clicking on the button labeled **Next** an overview of the batch units like that in figure 8.6 is shown.

The batch overview lists the batch units on the left and the contents of the selected batch unit on the right.

In this example, the two sequences are defined as separate batch units because they are located at the top level of the `Cloning` folder. Of the four subfolders of the `Cloning` folder (see figure 8.5), three are listed in this view. In each of these subfolders, any data elements that the analysis could use as input will be used unless action is taken at this point to exclude some of these. Clicking on the name of each batch unit on the left hand side will initially cause the display of all the data elements that can be used by the analysis tool. These elements will be used as a single set of input for a particular analysis run. So, for example, in figure 8.6, all the elements in the subfolder `Cloning vector library` that will be included as part of a single analysis run shown on the right-hand side of the dialog.

Note that the fourth subfolder of the `Cloning` folder, the `Enzyme lists` folder, is not listed as a batch unit. It is because it does not contain any data that can be used by the tool being launched.

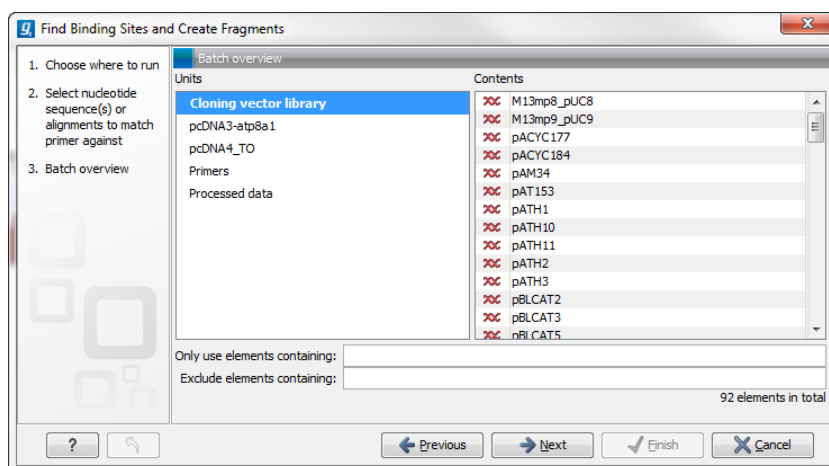

Figure 8.6: Overview of the batch run. At the bottom right, the number of files to be analysed, summed across all batch units, is shown, 92 in this case.

Including and excluding data elements in batch units There are three ways to refine the data elements that should be included in a batch unit, and thereby get taken forward into the analysis.

1. **Use the fields labeled Only use elements containing and Exclude elements containing at the bottom of the batch overview** This refinement is done based on data element names. For example, only paired reads might be desired for the analysis, in which case, putting the text "paired" into the **Only use elements containing** field might be useful.
2. **Remove a whole batch unit** Right-click on the batch unit to be removed and choose the option **Remove Batch Unit**.
3. **Remove a particular data element from a batch unit** Right click on the element of a batch unit to be removed and choose the option **Remove Element**. This can be useful when filtering based on name, described in the first option, cannot be used to refine the batch units specifically enough.

8.3.3 Parameters for batch runs

The subsequent dialogs depend on the analysis being run and the data being input. Generally, one of the batch units will be specified as the parameter prototype and will then be used to guide the choices in the dialogs. By default, the first batch unit (marked in bold) is used for this purpose. This can be changed by right-clicking another batch unit and choosing the option **Set as Parameter Prototype**.

When launching tools normally (non-batch runs), the Workbench does much validation of inputs and parameters. When running in batch, this validation is not performed. This means that some analyses will fail if combinations of input data and parameters are not right. Therefore we recommend that batching is used when the batch units are quite homogenous in terms of the type and size of data.

8.3.4 Running the analysis and organizing the results

The last step in setting up a batch analysis is to choose where to save the outputs (figure 8.7).

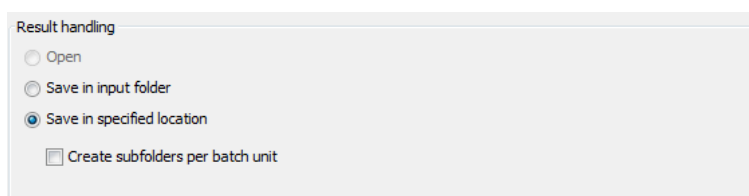

Figure 8.7: Options for saving results when the tool was run in batch.

The options available are:

- **Save in input folder** Save all outputs into the same folder as the input data. If the batch units consisted of folders, then the results of each analysis would be saved into the folder with the data it was generated using. If the batch units were individual data elements, then all the results will be placed into the same folder as those input data elements.
- **Save in specified location** Choose the folder where the outputs should be saved to, where when:
 - **Create subfolders per batch unit** is **unchecked**, all results for all batch units will be written to the specified folder.
 - **Create subfolders per batch unit** is **checked**, results for each batch unit will be written to a newly created subfolder of the selected folder. One subfolder is created per batch unit.

When the batch run is started, there will be one "master" process representing the overall batch job, and there will then be a separate process for each batch unit. The behavior this is different for Workbenches and Servers:

- On a Workbench, only one batch unit is run at a time. So when the first batch unit is done, the second will be started and so on. This avoids many parallel analyses that would draw on the same compute resources and slow down the computer.
- On a CLC Server, all the processes are placed in the queue, and the queue takes care of distributing the jobs. This means that if the server set-up includes multiple nodes, different batch unit analyses may be run in parallel.

To stop the whole batch run, stop the "master" process. From the Workbench, this can be done by finding the master process in the Processes tab in the bottom left hand corner. Click on the little triangle on the right hand side of the master process and choose the option **Stop**.

For some analyses, there is an extra option in the final step to create a log of the batch process. This log will be created in the beginning of the process and continually updated with information about the results. The log will either be saved with the results of the analysis or opened in a view with the results, depending on how you chose to handle the results.

8.3.5 Batch launching workflows with multiple inputs

This section describes the launching of workflows with multiple inputs, where **all** input elements will be changed per batch. This launch mechanism is not intended for workflows with multiple

input elements where one of the input elements remains the same in all batches, such as workflows meant to compare several tissues to a unique control tissue. At the moment, batch launching of such workflows is not possible, unless the common item is saved under different names as many times as there should be batches.

For workflows with multiple inputs where the inputs all need to change for each batch run, information specifying the grouping of the data elements and what role each element plays in a given analysis needs to be imported into the system from an Excel spreadsheet.

The requirements for launching such workflows in batch mode are:

- The workflow must be installed on the Workbench, meaning that the workflow is accessible from the Toolbox (as opposed to workflows accessible from the Navigation Area). See section 9.2 to learn how to install a workflow.
- The workflow is characterized by more than one input file, and all input elements are unique per batch. You cannot reuse a common input element (such as control reads for example), unless it has been saved under different names in the Navigation Area.
- An Excel format file (.xlsx/.xls) must be provided, with at least 3 different columns:
 - **Unique ID** The first column must contain either the exact name of the data elements to be used as inputs, or partial name information such that data elements being entered into the analysis can be uniquely identified and matched with the information contained in the spreadsheet (see section 3.2.2 to learn more about matching partial names).
 - **grouping** A second column must specify which data elements should be analyzed together in a given batch unit: this would be the ID of a single individual when comparing different tissues from the same individual (one individual per batch); or a family name when identifying variants existing within one family (one family per batch).
 - **Type** The third column must specify the type for each data element: the values in this column distinguish tissue samples from controls, or inform about the disease status of a family member (affected/non-affected/proband) when identifying disease causing variants.

(Figure 8.8) shows an example of a spreadsheet used in the case of tissue comparison. Note that the "grouping" and "type" are context specific, and will depend on the analysis performed, i.e., on the tools that constitute the workflow.

Sample ID = exact of partial name of the reads file to ensure a unique match between the reads and the metadata.	Patient ID = grouping values. Identical values will be analyzed together in one batch unit.	Type = value that defines which tissue is the control tissue and which is the sample tissue to be compared to the control.
23N	23	Normal
23T	23	Tumor
26N	26	Normal
26T	26	Tumor
27N	27	Normal
27T	27	Tumor
45N	45	Normal
45T	45	Tumor

Figure 8.8: Example of a spreadsheet necessary to run a workflow in batch, where the workflow intend to compare two tissue samples.

To launch a workflow with multiple input elements in batch mode, right click on the name of the workflow in the Toolbox and select the option "Run in Batch Mode..." (figure 8.9).

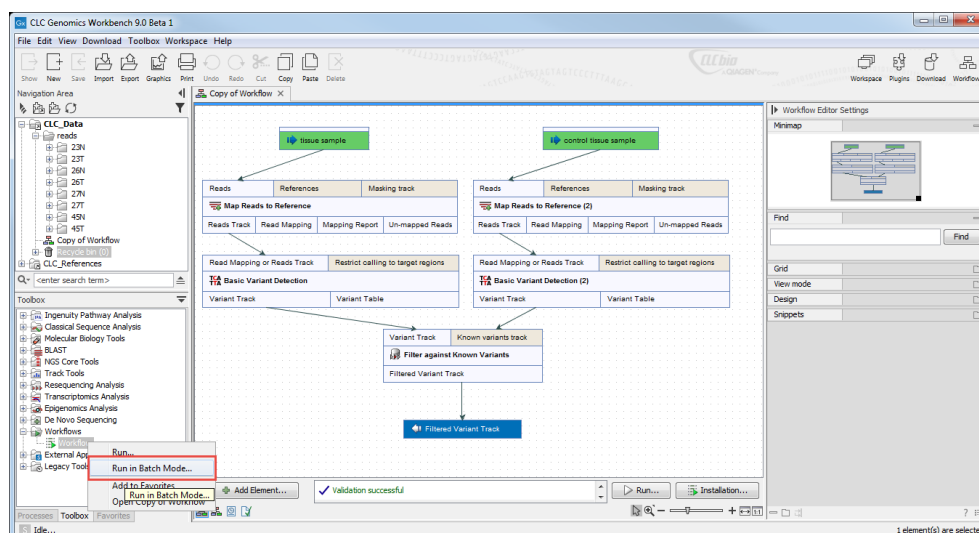

Figure 8.9: The option to "Run in Batch Mode..." appears in the context menu when you right click on the name of an installed workflow that has multiple input elements in the Toolbox panel.

A wizard opens and in the first window, you need to specify:

- An Excel file containing the information about the data to be analyzed (figure 8.10). Note that this file does not need to be saved in your Navigation Area. When it has been selected, the table found in the lower part of the wizard will show recapitulate the content of the Excel sheet. The location of the data for this analysis is not yet specified, so a red, no-entry sign is visible in the header of the first column.

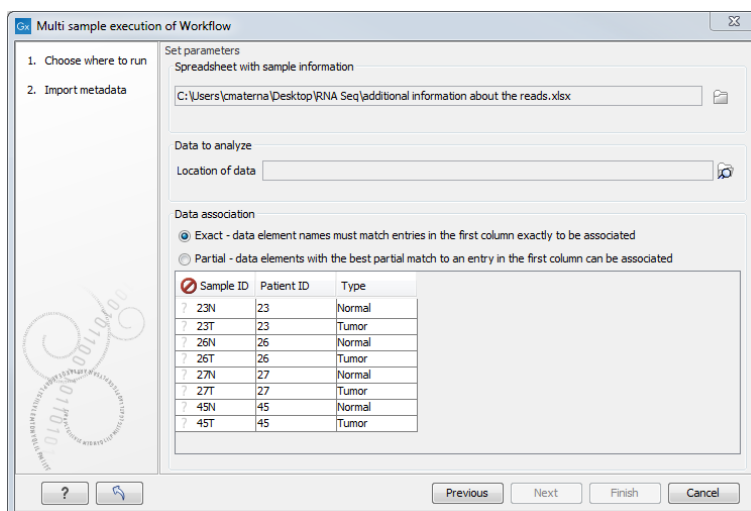

Figure 8.10: Select the information about the data to be analyzed and the folder holding the data to analyze. An example of an Excel sheet with the relevant information is shown.

- The location of the reads: click on the Navigation button next to the "Location of data" field and specify the folder(s) that contain(s) the data, as shown in figure 8.11.

Data elements within the selected folders are considered for the analysis. Subfolders and their contents are not considered unless the subfolder is also selected. Individual data elements cannot be selected.

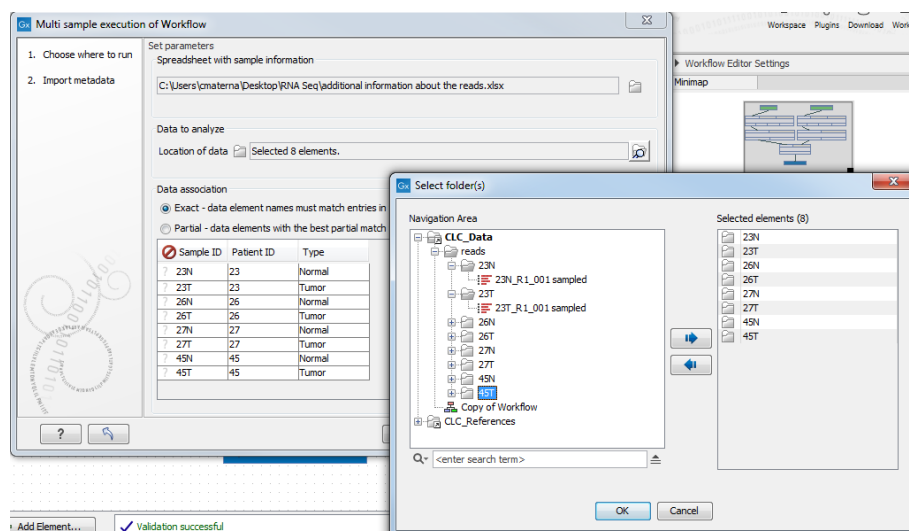

Figure 8.11: Select the folder(s) that contain(s) the data to be analyzed.

- Select the appropriate matching scheme - exact or partial. The matching rules applied are the same as those used for metadata association: "Exact" means that data element names must exactly match an entry in the first column of the Excel file; "Partial" matching allows for data elements names partially matching an entry in the first column. "Exact" is selected by default. Partial matching rules are described in detail in section 3.2.2.

An icon with a green check mark (✓) appears in the table preview next to rows where a data element corresponding to a row of the Excel sheet was uniquely identified. If no match can be made to a given row of the Excel sheet, a question mark (?) is displayed.

Graphical symbols are also presented in the header of the first column of the preview pane to give information about the overall status of the matching of rows in the Excel sheet with data elements in the Workbench:

- When no data elements match information in the Excel sheet, a red, no entry symbol (⊘) is displayed. In this situation, the button labeled **Next** is not enabled. This is the expected state before any data elements have been selected.
- A yellow exclamation mark (⚠) indicates that some, but not all rows in the Excel sheet have been matched to a data element in the selected folder(s).
- A green checkmark (✓) indicates that all rows in the Excel sheet have been matched to a data element in the selected folder(s).

In figure 8.12, the green check mark symbol in the header of the first column in the preview pane indicates that data elements were identified for each of the rows in the Excel sheet. You can click on the button labeled "Next".

The next wizard window is called "Select grouping parameters and analysis inputs".

- In the **Group by** drop down menu, select the name of the column containing information that specifies which samples should be analyzed together.

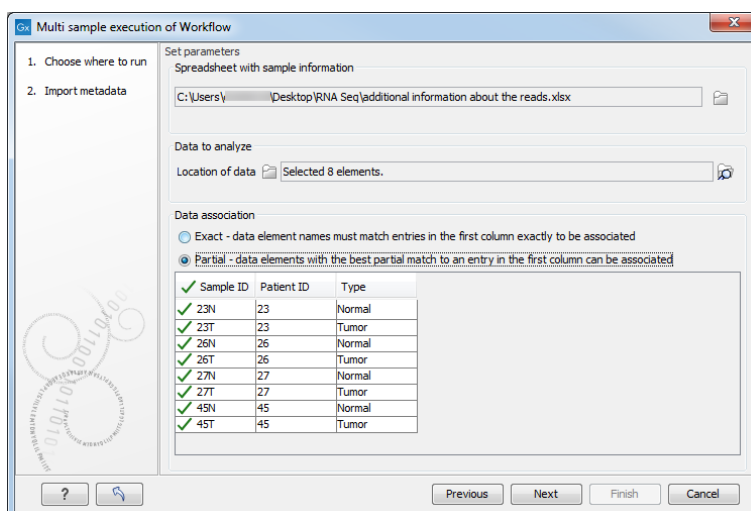

Figure 8.12: View of the Data Association table after all samples were successfully associated.

- In the **Type** drop down menu, select the name of the column containing information that can be mapped to the workflow input type of each data element.

In the same window you will need to further specify the inputs of the workflow. What needs to be specified here is dependant on the workflow itself.

An example is shown in figure 8.13. **Group by** is set to a column specifying "Patient ID", because each workflow run will analyze a sample pair. **Type** is set to the "Type" column, because the workflow inputs are either tumor or normal tissues. The sample columns section maps data elements to the different workflow inputs, in this case "Tissue sample" is set to "Tumor", and "Control tissue sample" to "Normal".

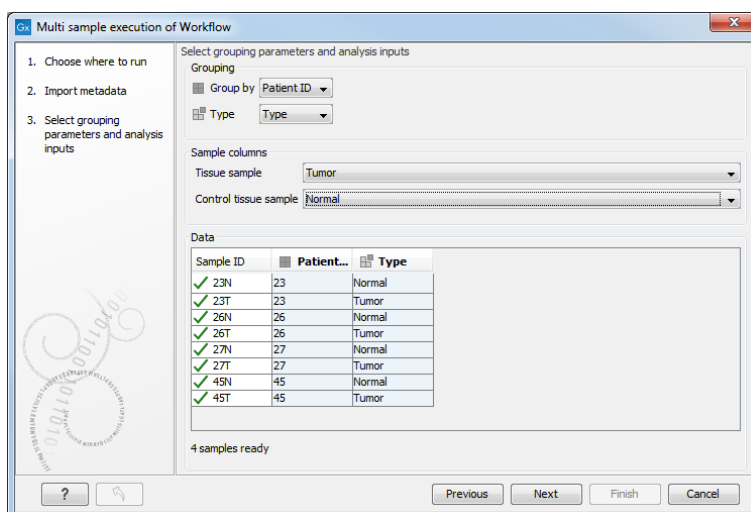

Figure 8.13: Grouping samples.

The rest of the wizard is dependant of the tools included in the workflow. Fill in the appropriate information and save the results of your workflow in a folder you can create in the Navigation Area.

As in a regular batching mode, you can use the progress bar to see how the job is progressing (figure 8.14): a process called "Batch Process" indicates how many batches have been

completed, while the ones situated above show the analysis progress of a particular batch unit.

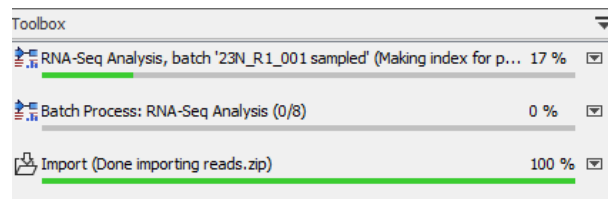

Figure 8.14: Check on the progress of your workflow being run in batch mode using the Processes tab below the Toolbox.

Chapter 9

Workflows

Contents



9.1	Creating a workflow	199
9.1.1	Adding workflow elements	199
9.1.2	Configuring workflow elements	200
9.1.3	Locking and unlocking parameters	202
9.1.4	Connecting workflow elements	203
9.1.5	Output	205
9.1.6	Input	207
9.1.7	Layout	209
9.1.8	Input modifying tools	211
9.1.9	Workflow validation	212
9.1.10	Workflow creation helper tools	214
9.1.11	Adding to workflows	214
9.1.12	Snippets in workflows	215
9.1.13	Change the order of tracks in the Genome Browser View	217
9.2	Distributing and installing workflows	218
9.2.1	Creating a workflow installation file	219
9.2.2	Installing a workflow	221
9.2.3	Managing workflows	222
9.2.4	Workflow identification and versioning	224
9.2.5	Automatic update of workflow elements	225
9.3	Executing a workflow	226
9.4	Open copy of installed workflow	227

The *CLC Genomics Workbench* provides a framework for creating, distributing, installing and running workflows. A workflow consists of a series of connected tools where the output of one tool is used as input for another tool. Once the workflow is set up, it can be installed (either in your own Workbench or it can be shared with colleagues and installed on a server). In that way it becomes possible to analyze lots of samples using the same standard pipeline, the same reference data and the same parameters.

This chapter will first explain how to create a new workflow, and next go into details about the installation and execution of a workflow.

Workflows created in the Workbench can also be installed on a *CLC Genomics Server*. For information about installing a workflow on the *CLC Genomics Server*, please see the user manual at <http://www.qiagenbioinformatics.com/support/manuals/>.

9.1 Creating a workflow

A workflow can be created by pressing the "Workflows" button () in the toolbar and then selecting "New Workflow..." ().

Alternatively, a workflow can be created via the menu bar:

File | New | Workflow ()

This will open a new view with a blank screen where a new workflow can be created.

9.1.1 Adding workflow elements

First, click the **Add Element** () button at the bottom (or use the shortcut Shift + Alt + E). This will bring up a dialog that lists the elements and tools, which can be added to a workflow (see figure 9.1).

Alternatively elements can be dragged directly from the **Toolbox** into the workflow. Only workflow enabled elements can be dropped in the workflow.

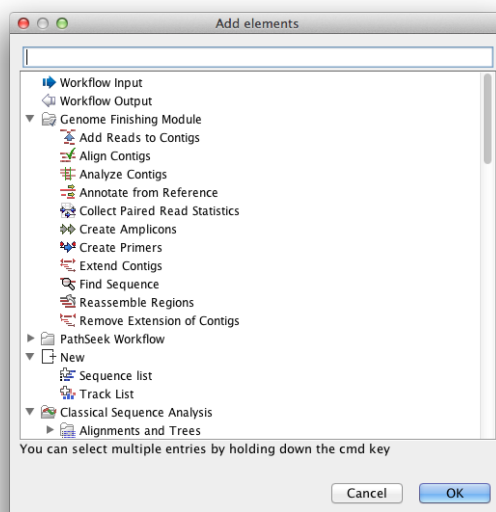



Figure 9.1: Adding elements in the workflow.

Elements that can be selected in the dialog are mostly tools from the Toolbox. However, there are two special elements on the list: the elements that are used for input and output. These are explained in section 9.1.6.

You can select more than one element in the dialog by pressing Ctrl ( on Mac) while selecting. Click OK when you have selected the relevant tools. You can add more later on if you wish.

You will now see the selected elements in the editor (see figure 9.2).

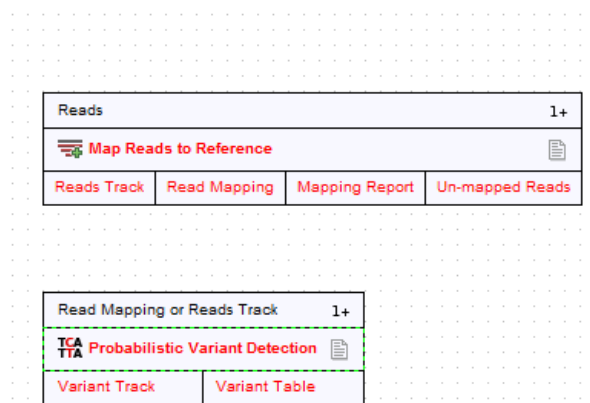

Figure 9.2: Read mapping and variant calling added to the workflow.

Once added, you can move and re-arrange the elements by dragging them with the mouse. To do this, click on part of the box containing the name of the element and then, keeping the mouse button depressed, drag the element to the desired position.

9.1.2 Configuring workflow elements

Each of the tools can be configured by right-clicking the name of the tool as shown in figure 9.3.

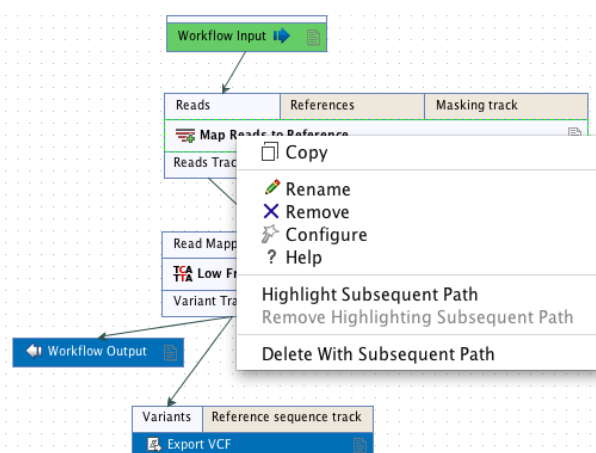

Figure 9.3: Configuring a tool.

The first option you are presented with is the option to **Rename** the element. This can be useful when you wish to discriminate between several copies of the same tool in a workflow. The name of the element is also visible as part of the process description when the workflow is run. To rename the element, right click on the tool in the workflow and select the "Rename" option, or click on the tool in the workflow and then press the F2 key.

The **Remove** option is used to remove elements from the workflow. The shortcut Alt + Shift + R removes all elements from the workflow.

You can also configure a given element using the **Configure** option from the right click menu or by double-clicking on the element. This opens a dialog with options for setting parameters,

selecting reference data, selecting the export destination of specified columns, etc. An example is shown in figure 9.4.

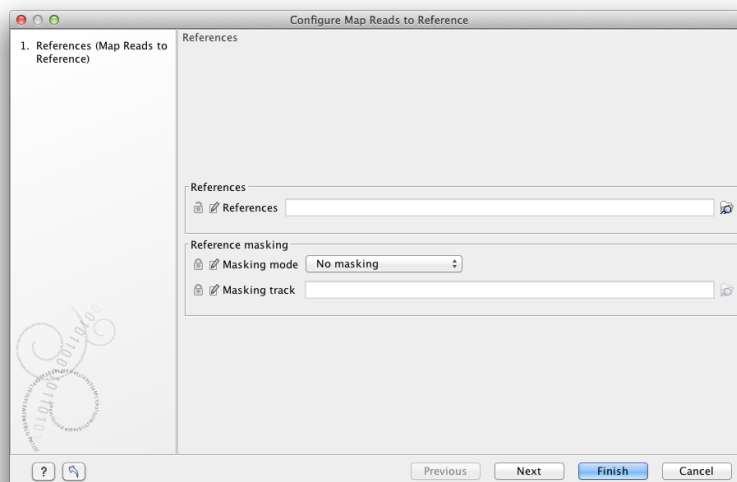

Figure 9.4: Configuring read mapper parameters.

Click through the dialogs using **Next** and press **Finish** when you are done. This saves the parameter settings for that tool. These are then applied when the workflow is executed.

You can also change the name of a parameter if you so wish, for example, to help with usability for the intended users of a workflow. To do this, click on the edit icon (✎) and enter a new name.

Special consideration should be given when configuring reference data in a workflow. For example, when configuring a read mapping tool, such as shown in figure 9.3, you have to define a reference genome that sequences will be mapped to. You configure this by selecting data in the **Navigation Area**. If you distribute the workflow and it is installed on a different system, where that data is not accessible in same relative location, the workflow installation procedure will involve defining new reference data to use. This is explained in more detail in section 9.2.

The lock icons in the dialog are used for specifying whether the parameter should be locked and unlocked as described in the next section. Locking parameters means that the workflow will be run with the same parameters every time; the user will not be prompted to supply values for locked parameters when they launch the workflow.

Once an element has been configured, the workflow element will be shaded with a darker color to help in distinguishing which elements have been configured.

The **Highlight Subsequent Path** option causes the element that was clicked on, and all the elements downstream of that one, to be highlighted. Other elements will be grayed out (figure 9.5). The **Remove Highlighting Subsequent Path** option reverts the highlighting, returning to the normal workflow layout.

In some workflows, many elements use the same reference data. There is a quick way of configuring these: right-click on the empty space and choose **Configure All References**. A dialog then appears listing all the reference data needed by the workflow. When you click on the button labeled **Finish**, only the elements where the 'active' column is checked will be configured.

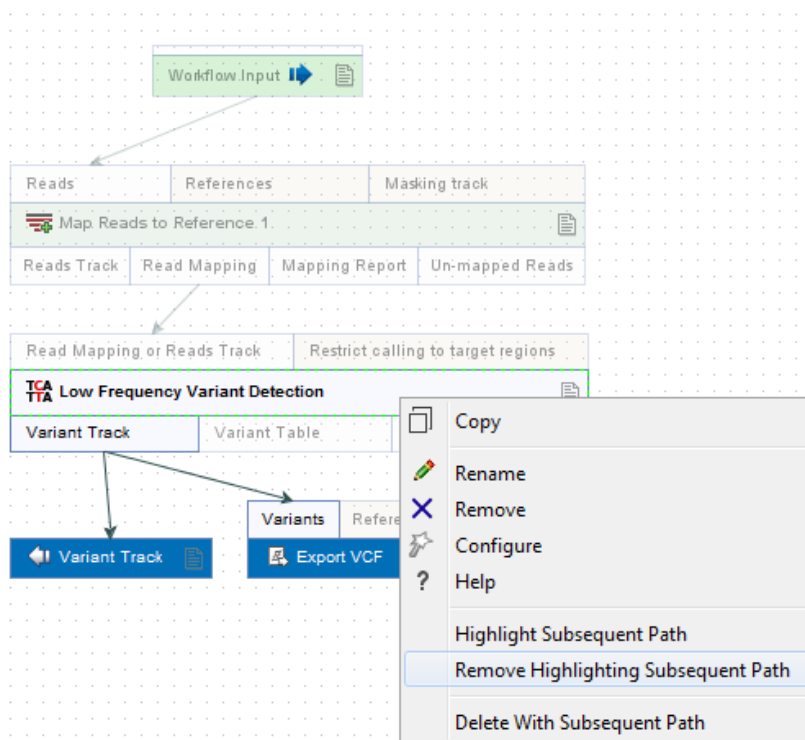



Figure 9.5: Highlight path from the selected tool and downstream.

Similarly, instead of configuring the various tools individually, the **Configuration Editor** enables the specification of all settings, references, masking parameters etc. through a single wizard window (figure 9.6). This editor is accessed through the  icon located in the lower left corner.

9.1.3 Locking and unlocking parameters

Figure 9.7 illustrates the different stages in the lifecycle of a workflow.

The first stage, workflow creation, was explained in the section above. The next stage, the installation of a workflow on a Workbench or Server is explained in section 9.2). The final stage is the execution of the workflow via the **Toolbox**, just like other tools.

During the creation step, the workflow author can specify which parameters should be locked or unlocked. If a parameter is locked, it cannot be changed in the installation or the execution step. Conversely, if it is left open, that parameter can be changed, either when running the Workflow or when installing it. See section 9.2). The lock icons shown in figure 9.4 specify whether the parameter is left open or whether it is locked.

By default, data parameters are unlocked. When installing the workflow on a different system to the one where it was created, the connection to the data needs to be re-established. This is only possible when the parameter is unlocked. Data parameters should only be locked if they should not be set, or if the workflow will only be installed in a setting where there is access to the same data in the same location as the system where the Workflow was created.

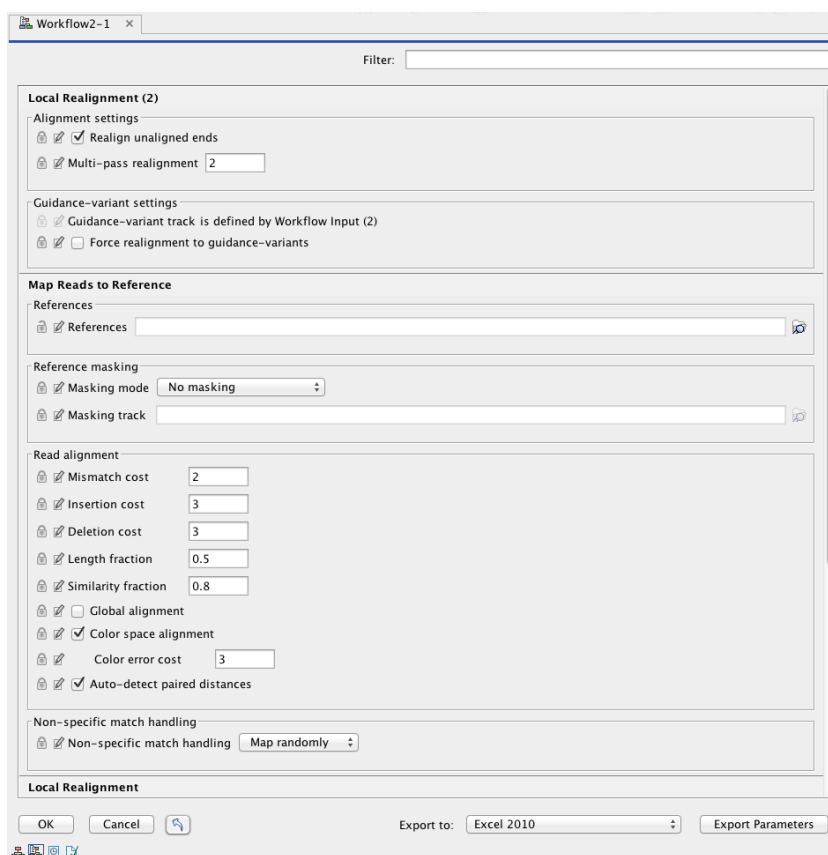

Figure 9.6: The Configuration Editor can be used to configure all the tools that can be configured in a given Workflow.

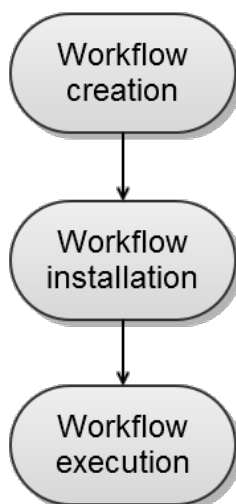

Figure 9.7: The life cycle of a workflow.

9.1.4 Connecting workflow elements

Figure 9.8 explains the different parts of a workflow element.

At the top of each element a description of the required type of input is found. In the right-hand side, a symbol specifies whether the element accepts multiple incoming connections, e.g. +1

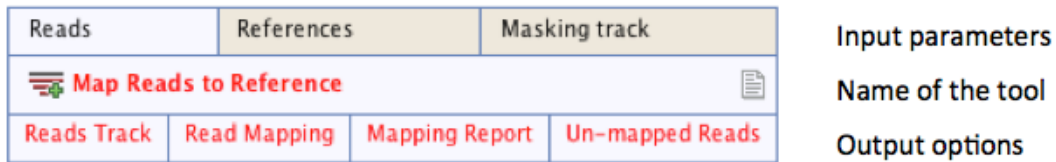

Figure 9.8: A workflow element consists of three parts: input, name of the tool, and output.

means that more than one output can be connected, and no symbol means that only one can be connected. At the bottom of each element there are a number of small boxes that represent the different kinds of output that is produced. In the example with the read mapper shown in figure 9.2, the read mapper is able to produce a reads track, a report etc.

Each of the output boxes can be connected to further analysis in three ways:

- By dragging with the mouse from the output into the input box of the next element. This is shown in figure 9.9. A green border around the box will tell you when the mouse button can be released, and an arrow will connect the two elements (see figure 9.10).
- Right-clicking the output box will display a list of the possible elements that this output could be connected to. You can also right-click the input box of an element and connect this to a matching output of another element.
- Alternatively, if the element to connect to is not already added, you can right-click the output and choose **Add Element to be Connected**. This will bring up the dialog from figure 9.1, but only showing the tools that accepts this particular output. Selecting a tool will both add it to the workflow and connect with the output you selected. You can also add an upstream element of workflow in the same way by right-clicking the input box.

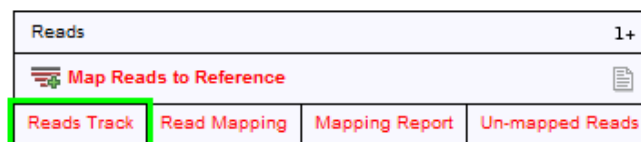

Figure 9.9: Dragging the reads track output with the mouse.

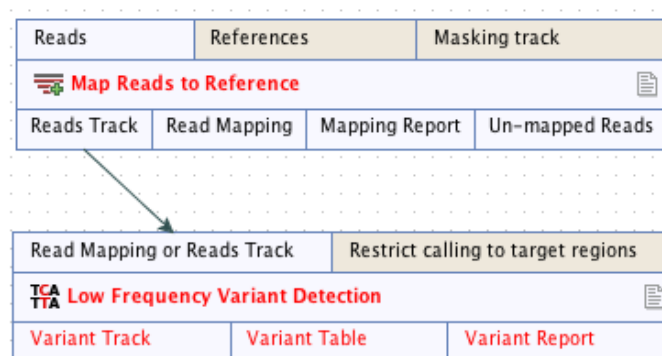

Figure 9.10: The reads track is now used for variant calling.

All the logic of combining output and input is based on matching the type of input. So the read mapper creates a reads track and a report as output. The variant caller accepts reads tracks

as input but not mapping reports. This means that you will not be able to connect the mapping report to the variant caller.

Figure 9.11 demonstrates how one tool can receive input from two different sources; 1) a reads track that is the input that hold the data that is to be analyzed (in this case reads that is to be locally realigned), and 2) a parameter that can have different functions depending on the tool that it is connected to (in this case the InDel track is used as a guidance track for the local realignment. In other situations the parameter track could be used for e.g. annotation or could provide a reference sequence).

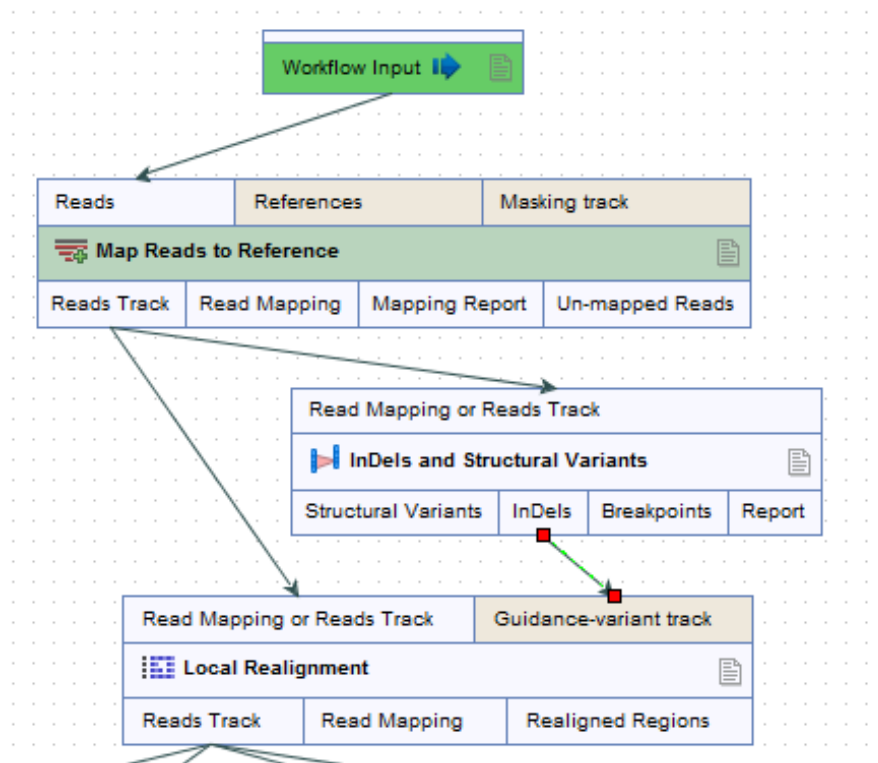

Figure 9.11: A tool can receive input from both the generated output from another tool (in this example a reads track) and from a parameter (in this case indels detected with the InDels and Structural Variants tool).

9.1.5 Output

Besides connecting the elements together, you have to decide what the input and the output of the workflow should be. We will first look at specification of the output, which is done by right-clicking the output box of any tool and selecting **Use as Workflow Output** as shown in figure 9.12.

You can mark several outputs this way throughout the workflow. Note that no intermediate results are saved unless they are marked as workflow output. In fact, when the workflow is executed, all the intermediate results are indeed saved temporarily, but they are automatically deleted when the workflow is completed. However, if a workflow fails, the intermediate results are not deleted and will be found in a folder named after the workflow with the mention "intermediate".

By double-clicking the output box, you can specify how the result should be named as shown in

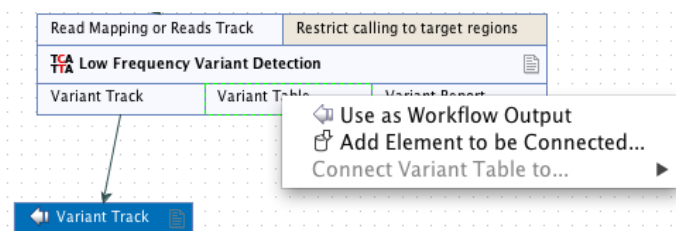

Figure 9.12: Selecting a workflow output.

figure 9.13.

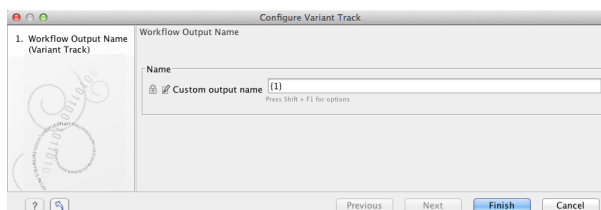

Figure 9.13: Specifying naming of a workflow output.

In this dialog you can enter a name for the output. Dynamic placeholders are available, which can help in setting up specific and standardized names for outputs. If you mouse over the Custom output name field in the dialog, the placeholders are listed. You can also click on Shift+F1 to see the options. The placeholders below are available. They are not case specific.

- **{name}** or **{1}** - default name for the tool's output
- **{input}** or **{2}** - the name of the workflow input (and not the input to a particular tool within a workflow).
- **{user}** - name of the user who launched the job
- **{host}** - name of the machine the job is run on
- **{year}**, **{month}**, **{day}**, **{hour}**, **{minute}**, and **{second}** - timestamp information based on the time an output is created. Using these placeholders, items generated by a workflow at different times can have different filenames.

When deciding on an output name, you can choose any combination of the placeholders, as well as custom names and punctuation, for example, `{input}({day}-{month}-{year})`. A meaningful name to a variant track could be `{2} variant track` as shown in figure 9.14. Here, if your workflow input was named `Sample 1`, the result would be "Sample 1 variant track".

The placeholders available for exports are slightly different than for other workflow outputs and are described in section 6.5.

It is also possible to save workflow outputs into subfolders by using a forward slash character `/` at the start of the output name definition. For example the custom output name `/variants/{name}` refers to a folder "variants" that would lie under the location selected for storing the workflow outputs. When defining subfolders for outputs, all later forward slash characters in the configuration, except the last one, will be interpreted as further levels of

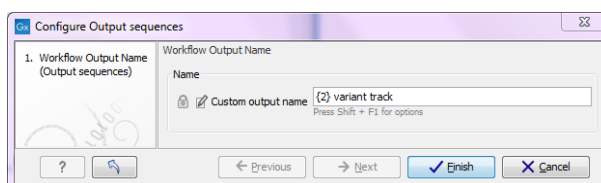

Figure 9.14: Providing a custom name for the result.

subfolders. For example, a name like `/variants/level2/level3/myoutput` would put the data item called `myoutput` into a folder called `level3` within a folder called `level2`, which itself is inside a folder called `variants`. The `variants` folder would be placed under the location selected for storing the workflow outputs. If the folders specified in the configuration do not already exist, they are created.

Exports are different to other workflow outputs in this regard; subfolders cannot be defined using the Custom file name field. If slash characters are included in the Custom file name field for an export, all text before and including the final slash character is ignored.

9.1.6 Input

In addition to output, you also have to specify where the data should go into the workflow by adding an element called **Workflow Input**. This can be done by:

- Right-clicking the input box of the first tool and choosing **Connect to Workflow Input**. By dragging from the workflow input box to other input boxes several tools can use the input data directly.
- Pressing the button labeled **Add Element** (or right-click somewhere in the workflow background area and select **Add Element** from the menu that appears). The input box must then be connected to the relevant tool(s) in the workflow by dragging from the Workflow Input box to the "input description" part of the relevant tool(s) in the workflow.

At this point you have only prepared the workflow for receiving input data, but not specified which data to use as input. To be able to do this you must first save the workflow. When this has been done, the button labeled **Run** is enabled which allows you to start executing the workflow. When you click on the button labeled **Run** you will be asked to provide the input data.

Multiple input files can be used when:

- Data is generated within the Workflow
- Data is held within the Workbench
- Data is a combination of the two situations above

It can be useful to rename input elements when working with multiple input files, so that it is easy to discriminate between them when they are shown during workflow execution.

Note: Once the multiple input feature is used in a workflow, it is not possible to run the workflow in batch mode.

You can choose the order in which inputs will be processed by an element by right clicking on the input parameter box at the top of the element and choosing the option **Order Inputs**. This is most relevant for elements involved in data visualization. The feature **Order Inputs** is enabled when there are at least two inputs connected to the element (see figure 9.15). A small window will open, in which you can indicate the preferred order of the inputs to that element by moving them up and down in the list (figure 9.16). From this point forward, the order of the inputs is displayed on the branches connecting the inputs to elements.

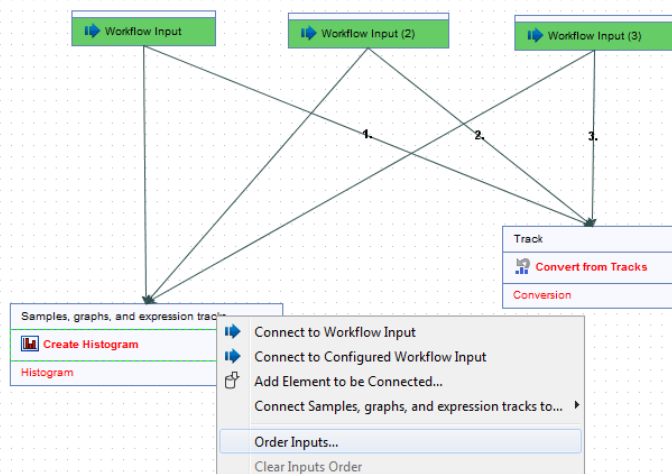

Figure 9.15: Right-click on the input parameter box to see the Order Inputs function.

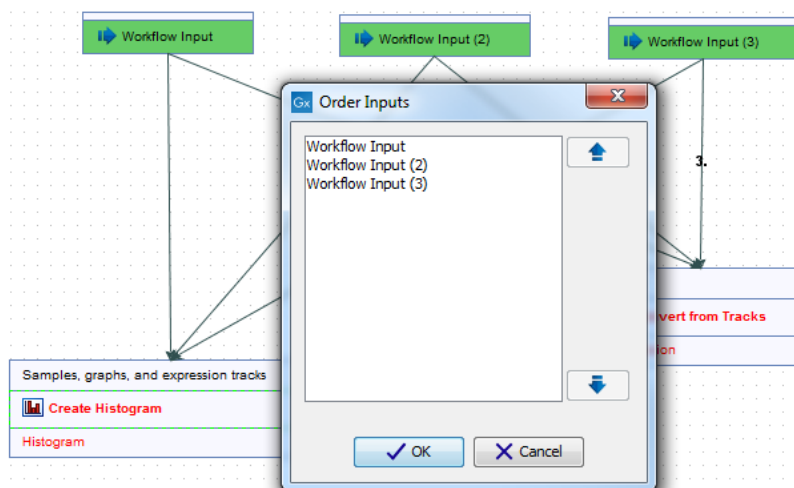

Figure 9.16: Define the inputs order for the element.

The feature **Order Workflow Inputs** allows you to set the order that a user will be asked for each input when they run the workflow. This option is enabled as soon as the workflow has two or more inputs (figure 9.17). Right click on empty space in the Workflow editor to start this tool. A small window will open in which the different inputs can be moved up and down to indicate the desired order (figure 9.18).

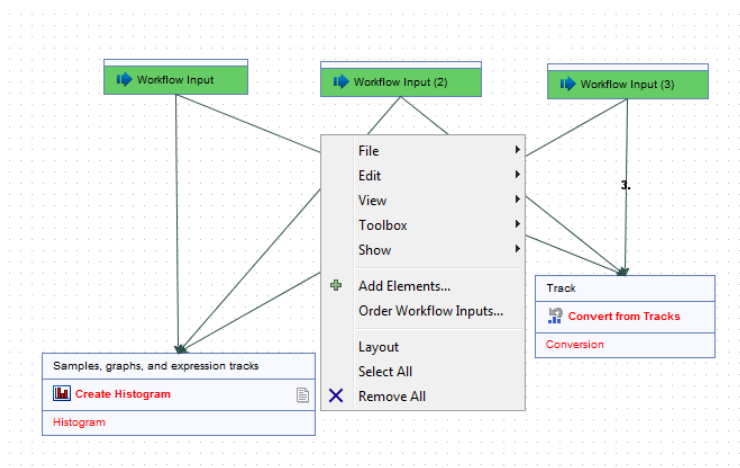

Figure 9.17: Right click on empty space in the Workflow editor to open the Order Workflow Inputs tool.

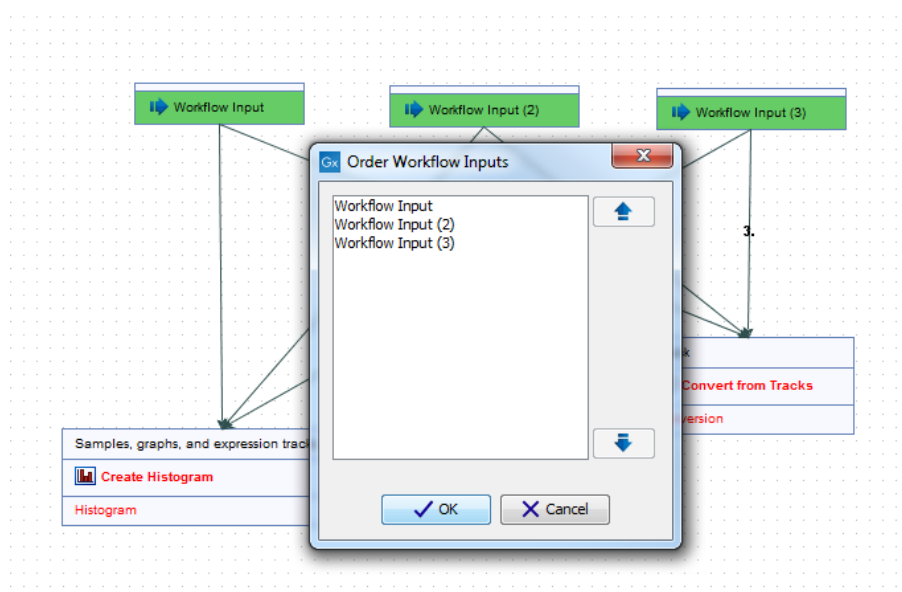

Figure 9.18: Define the order of the inputs for the workflow.

The example in figure 9.19 shows how to generate a track list in a workflow. Any track based on a compatible genome can be added to the same track list. This includes reference tracks as well as track results generated by elements of that workflow. In the latter case, only those for which a workflow output element has been configured can be included in a track list.

9.1.7 Layout

The workflow layout can be adjusted automatically. Right clicking in the workflow editor will bring up a pop-up menu with the option "Layout". Click on "Layout" to adjust the layout of the selected elements (Figure 9.20). Only elements that have been connected will be adjusted.

Note! The layout can also be adjusted with the quick command Shift + Alt + L.

Note! It is very easy to make an image of the workflow. Simply select the elements in the workflow (this can be done pressing Ctrl + A, by dragging the mouse around the workflow while

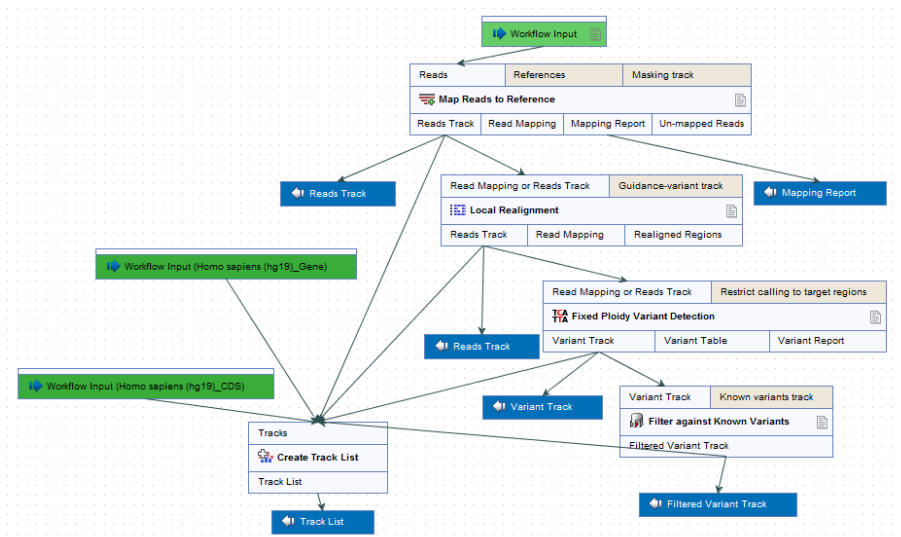

Figure 9.19: Generation of a track list including data generated within the Workflow, as well as data held in the Workbench.

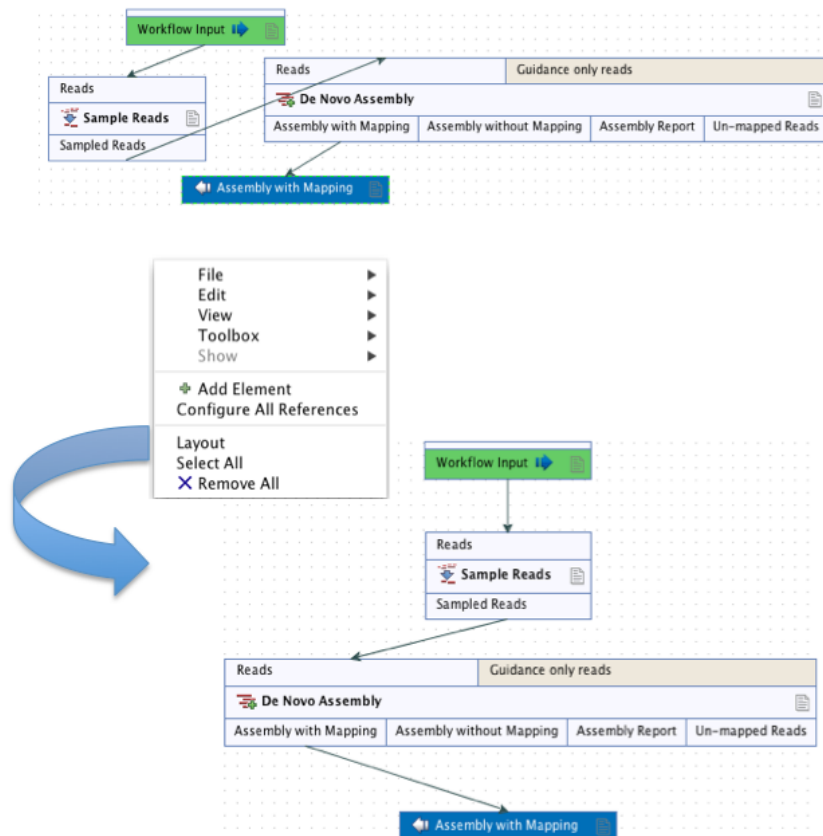



Figure 9.20: A workflow layout can be adjusted automatically with the "Layout" function.

holding down the left mouse button, or by right clicking in the editor and then selecting "Select All"), then press the Copy button in the toolbar () or CTRL + C. Press Ctrl + V to paste the image into the wanted destination e.g. an email or a text or presentation program.

9.1.8 Input modifying tools

An input modifying tool is a tool that manipulates its input objects (e.g. adds annotations) without producing a new object. This behavior differs from the rest of the tools and requires special handling in the workflow.

In the workflow an input modifying tool is marked with the symbol (M) (figure 9.21).

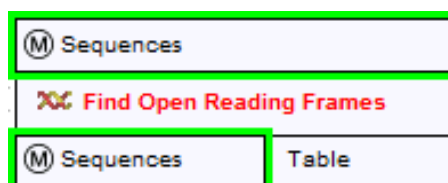

Figure 9.21: Input modifying tools are marked with the letter M.

Restrictions apply to workflows that contain input modifying tools. For example, branches are not allowed where one of the elements is a modifying tool (see figure 9.22), as it cannot be guaranteed which workflow branch will be executed first, which in turn means that different runs can result in production of different objects. Hence, if a workflow is constructed with a branch where one of the succeeding elements is a modifying tool, a message in red letters will appear saying "Branching before a modifying tool can lead to non-deterministic behavior". In such a situation the "Run" and "Create Installer" buttons will be disabled (figure 9.22).

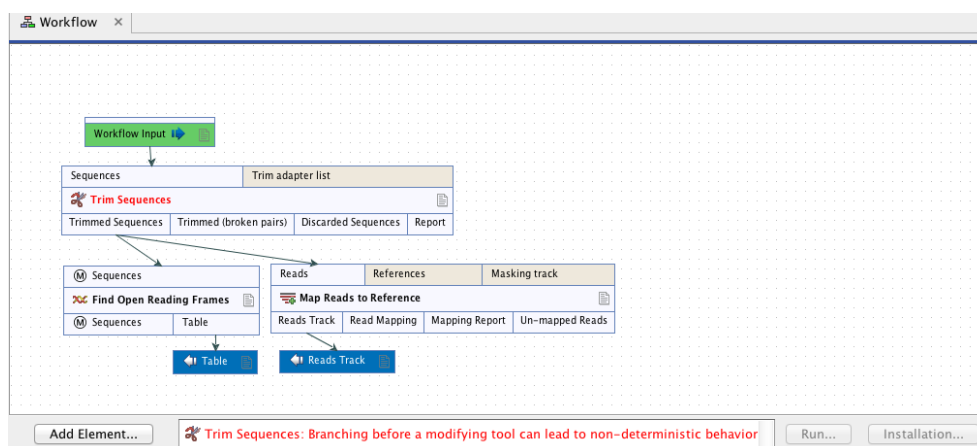

Figure 9.22: A branch containing an input modifying tool is not allowed in a workflow.

The problem can be solved by resolving the branch by putting the elements in the right order (with respect to order of execution). This is shown in figure 9.23 that also shows that the "Run" and "Create Installer" buttons are now enabled. In addition, a message in green letters has appeared saying "Validation successful".

As input modifying tools only modify existing objects without producing a new object, it is not possible to add a workflow output element directly after an input modifying tool (figure 9.24). A workflow output element can only be added when other tools than input modifying tools are included in the workflow.

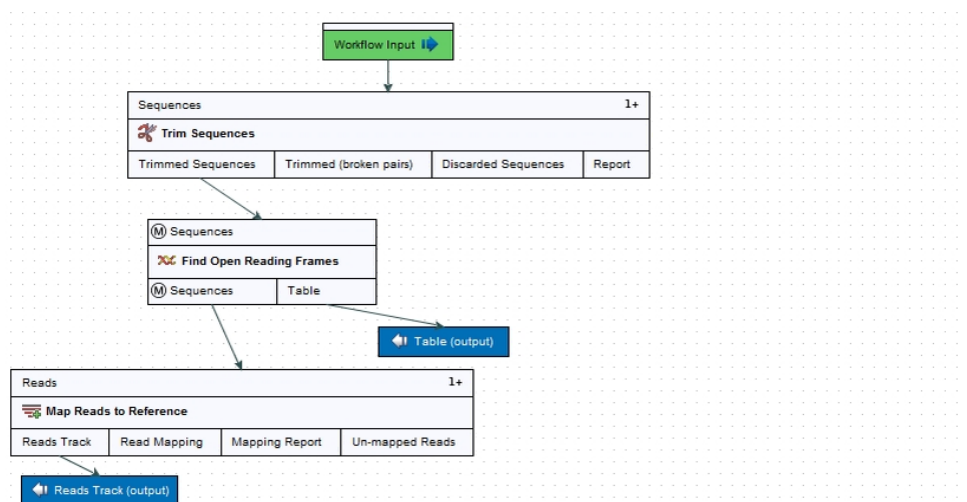

Figure 9.23: A branch containing an input modifying tool has been resolved and the workflow can now be run or installed.

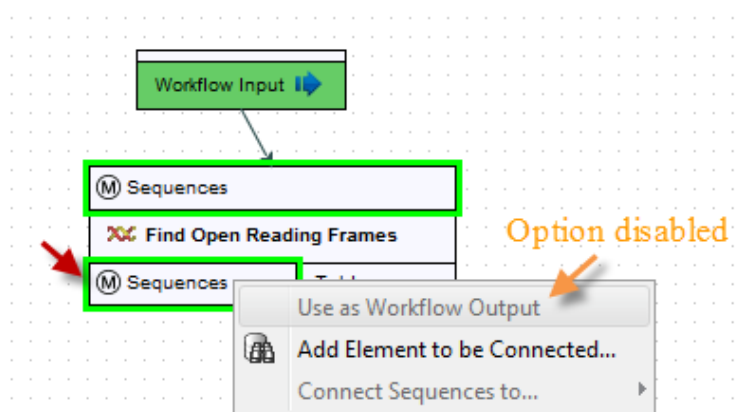

Figure 9.24: A workflow output element cannot be added if the workflow only contains an input modifying tool.

If the situation occur where more input modifying tools are used succeedingly, a copy of the object will be created in addition to using the modified object as input at the next step of the chain (see figure 9.25). In order to see this output you must right click on the output option (marked with a red arrow in figure 9.25) and select "Use as Workflow Output".

When running a workflow where a workflow output has been added after the first input modifying tool in the chain (see figure 9.26) the output arrow is marked with "copy" to indicate that this is a copy of the result that is used as input at the next level in the chain. When running this workflow you will be able to see the copy of the output from the first input modifying tool in the **Navigation Area** (at the destination that you selected when running the workflow).

9.1.9 Workflow validation

At the bottom of the view, there is a text with a status of the workflow (see figure 9.27). It will inform about the actions you need to take to finalize the workflow.

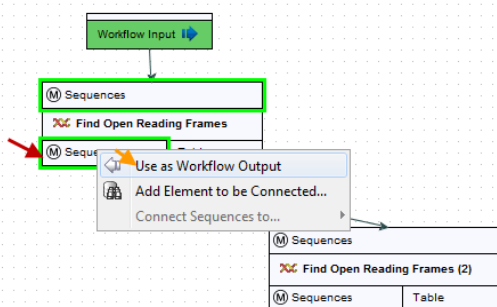

Figure 9.25: A workflow output element can be added when more than one input modifying tool is used succeedingly (despite that the workflow only contains input modifying tools). Select "Use as Workflow Output" to make a copy of the output.

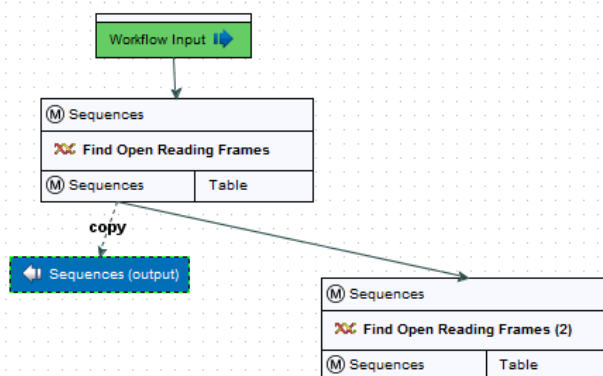

Figure 9.26: A workflow output element can be added when more than one input modifying tool is used succeedingly (despite that the workflow only contains input modifying tools). Note that this output is marked with "copy" to indicate that this is a copy of the result that is used as input at the next level in the chain.

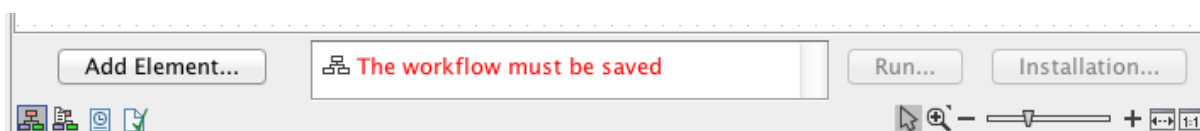

Figure 9.27: A workflow is constantly validated at the bottom of the view.

The validation may contain several lines of text. Scroll the list to see more lines. If one of the errors pertain to a specific element in the workflow, clicking the error will highlight this element.

The following needs to be in place before a workflow can be executed:

- All input boxes need to be connected either to the workflow input or to the output of other tools.
- At least one output box from each tool needs to be connected to either a workflow output or to the input box of another tool.
- Additional checks that the workflow is consistent.

Once these conditions are fulfilled, the status will be "Validation successful", the **Run** button is enabled. Clicking this button will enable you to try running a data set through the workflow to test

that it produces the expected results. If reference data has not been configured (see section 9.1.2), there will be a dialog asking for this as part of the test run.

9.1.10 Workflow creation helper tools

In the workflow editor **Side Panel**, you will find the following workflow display settings that can be useful to know (figure 9.28):

Grid

- **Enable grid** You can display a grid and control the spacing and color of the grid. Per default, the grid is shown, and the workflow elements snap to the grid when they are moved around.

View mode

- **Collapsed** The elements of the workflow can be collapsed to allow a cleaner view and especially for large workflows this can be useful.
- **Highlight used elements** Ticking **Highlight used elements** (or using the shortcut Alt + Shift + U) will show all elements that are used in the workflow whereas unused elements are grayed out.
- **Rulers** Vertical and horizontal rules can be visualised
- **Auto Layout** Ticking **Auto Layout** will ensure rearrangement of elements once new elements are added.
- **Connections to background** Connecting arrows are shown behind elements. This may ease reading of element names and accessible parameters.

Design

- **Round elements** Enable rounding of the element boxes.
- **Show shadow** Shadows of element boxes can be added.
- **Configured elements** Background color can be customized.
- **Input elements** Background color can be customized.
- **Edges** Color of connecting arrows can be customized.

9.1.11 Adding to workflows

Additional elements can be added to an already existing workflow by dragging it from the navigation area into the workflow editor and joining more elements as necessary. The new workflow must be saved and validated before it can be executed. Two or more workflows can be joined by dragging and dropping one from the Navigation Area, into another that is already open in the main viewing area. The output of one must be connected to the input of the next to allow the whole workflow to run in one go.

Workflows do not need to be valid to be dragged in to the workflow editor, but they must have been migrated to the current version of the workbench.

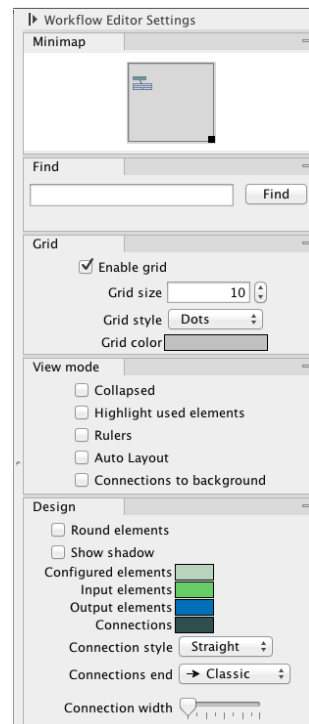

Figure 9.28: The Side Panel of the workflow editor.

9.1.12 Snippets in workflows

When creating a new workflow, you will often have a number of connected elements that are shared between workflows. Instead of building workflows from scratch it is possible to reuse components of an existing workflow. These components are called snippets and can exist of e.g. a read mapper and a variant caller.

Snippets can be created from an existing workflow by selecting the elements and the arrows connecting the selected elements. Next, you must right-click in the center of one of the selected elements. This will bring up the menu shown in figure 9.29.

When you have clicked on "Install as snippet" the dialog shown in figure 9.30 will appear. The dialog allows you to name the snippet and view the selected elements that are included in the snippet. You are also asked to specify whether or not you want to include the configuration of the selected elements and save it in the snippet or to only save the elements in their default configuration.

Click on the button labeled **OK**. This will install your snippet and the installed snippet will now appear in the **Side Panel** under the "Snippets" tab (see figure 9.31)

Right-clicking on the installed snippet in the **Side Panel** will bring up the following options (figure 9.32):

- **Add** Adds the snippet to the current open workflow
- **View** Opens a dialog showing the snippet, which allows you to see the structure
- **Rename** Allows renaming of the snippet.
- **Configure** Allows to change the configuration of the installed snippet.

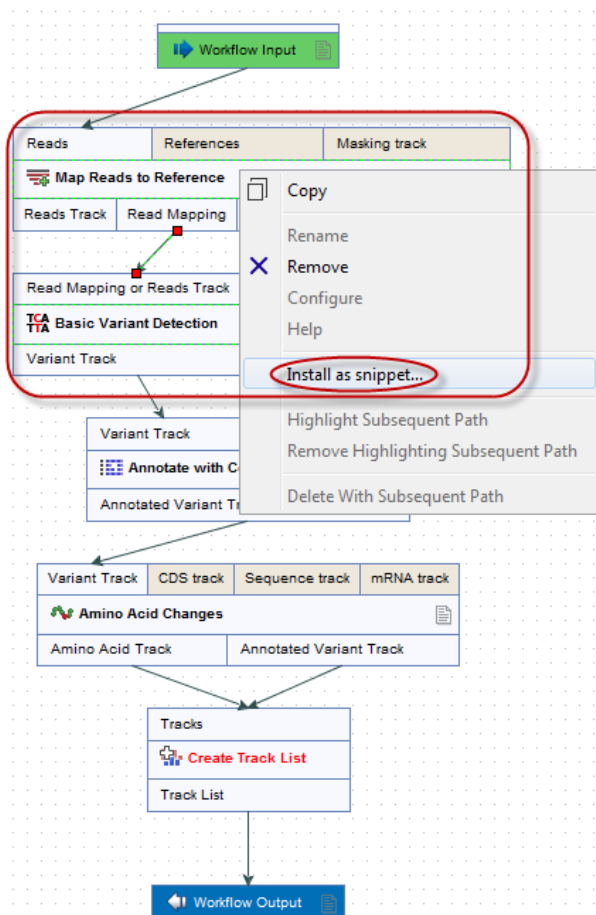

Figure 9.29: The selected elements are highlighted with a red box in this figure. Select "Install as snippet".

- **Uninstall** Removes the snippet.
- **Export** Exports the snippet to ones computer, allowing to share it.
- **Migrate** Migrates the snippet (if migration is required).

If you right-click on the top-level folder you get the options shown in figure 9.33:

- **Create new group** Creates a new folder under the selected folder.
- **Remove group** Removes the selected group (not available for the top-level folder)
- **Rename group** Renames the selected group (not available for the top-level folder)

In the **Side Panel** it is possible to drag and drop a snippet between groups to be able to rearrange and order the snippets as desired. An exported snippet can either be installed by clicking on the 'Install from file' button or by dragging and dropping the exported file directly into the folder where it should be installed.

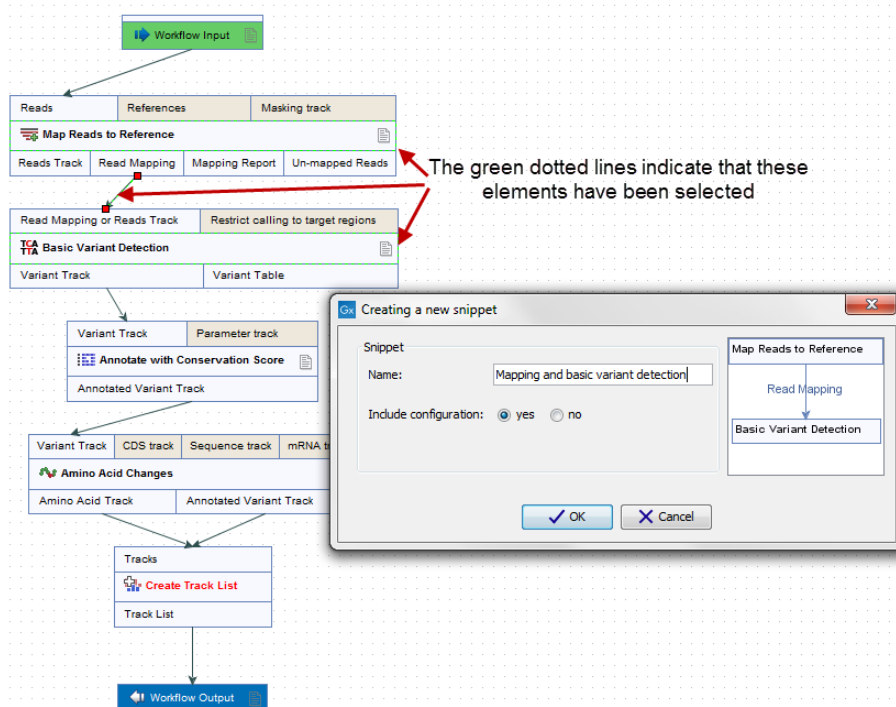

Figure 9.30: In the "Create a new snippet" dialog you can name the snippet and select whether or not you would like to include the configuration. In the right-hand side of the dialog you can see the elements that are included in the snippet.

Add a snippet to a workflow Snippets can be added to a workflow in two different ways; it can either be added by dragging and dropping the snippet from the **Side Panel** into the workflow editor, or it can be added by using the "Add elements" option that is shown in figure 9.34.

9.1.13 Change the order of tracks in the Genome Browser View

When modifying an existing workflow or creating a custom workflow that include the tool "**Create New Genome Browser View**" you may want to be able to adjust the order in which the tracks are shown in the Genome Browser View. To do this, display a view of the workflow layout, click once on the top part of the tool "Create New Genome Browser View" labeled "Tracks" followed by a right-click. In the pop up menu that appears (figure 9.35), choose the option "Order Workflow Inputs".

This opens a new pop up window (figure 9.36 where you can see a list of all the inputs that are connected with the input channel of the "Create New Genome Browser View" tool. Use the arrows found in the left-hand side to move the tracks up or down until you have the desired track order in your Genome Browser View.

If the workflow also generated several variant tracks, the variant table generated from the uppermost read mapping will open in split view with the Genome Browser View. By changing the Order of Inputs you can thus also influence which variant table should open in split view.

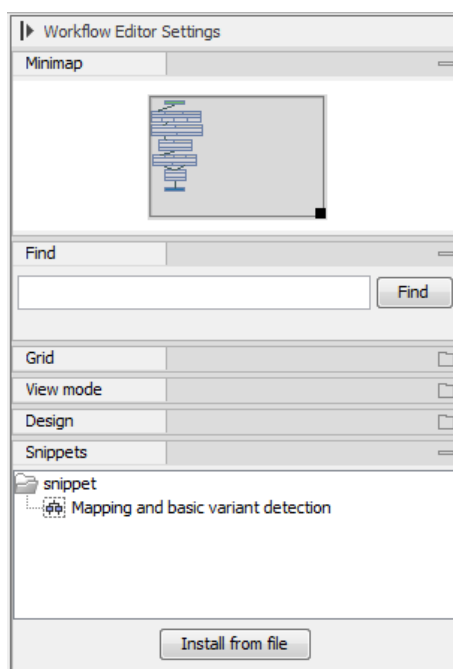

Figure 9.31: When a snippet is installed, it appears in the Side Panel under the "Snippets" tab.

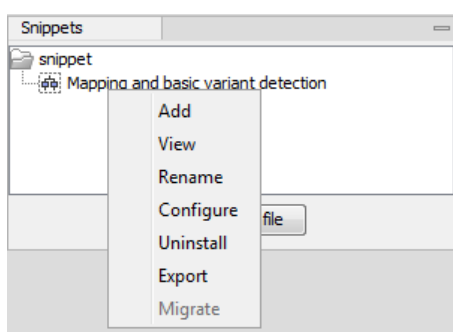

Figure 9.32: Right-clicking on an installed snippet brings up a range of different options.

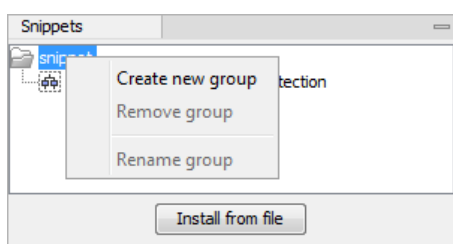

Figure 9.33: Right-clicking on the snippet top-level folder makes it possible to manipulate the groups.

9.2 Distributing and installing workflows

Once the workflow has been configured, you can use the **Run** button (see section 9.1.9) to process data through the workflow, but the real power of the workflow is its ability to be distributed and installed in the **Toolbox** alongside the other tools that come with the *CLC Genomics Workbench*, as well as the ability to install the same workflow on a *CLC Genomics Server*. The mechanism for distributing the workflow is a workflow installer file which can be created from the workflow editor and distributed and installed in any Workbench or Server.

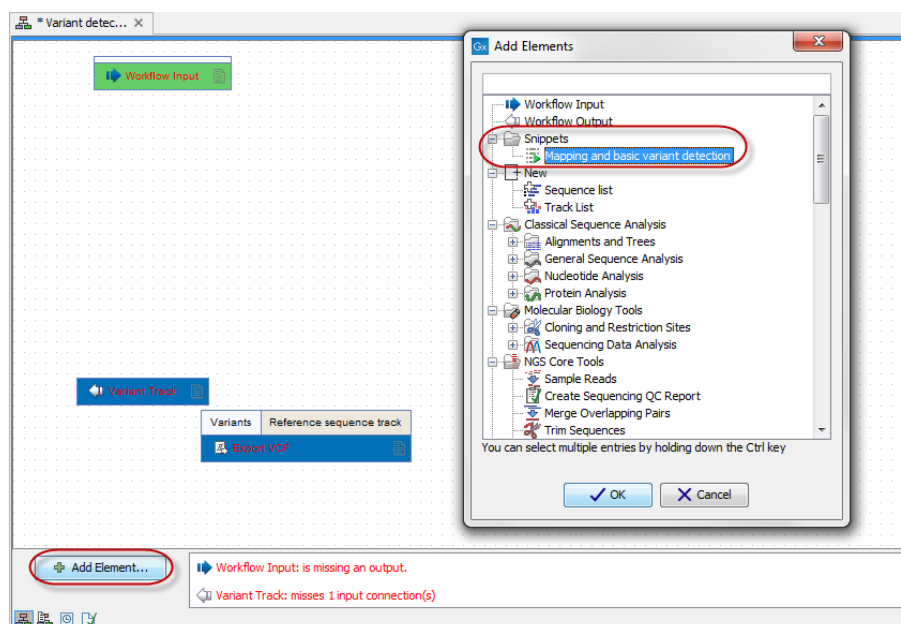

Figure 9.34: Snippets can be added to a workflow in the workflow editor using the 'Add Elements' button found in the lower left corner.

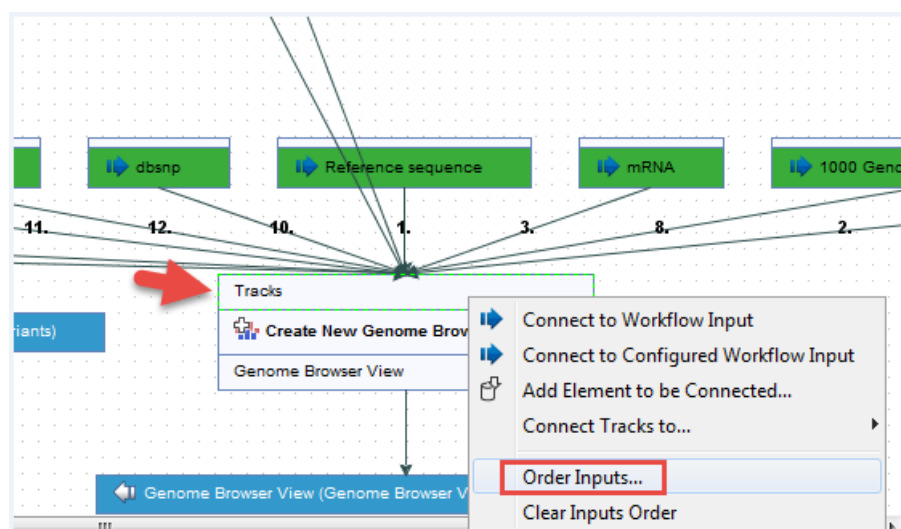

Figure 9.35: Right click on the workflow layout and choose the option "Order Inputs...".

9.2.1 Creating a workflow installation file

At the bottom of the workflow editor, click the **Create Installer** button (or use the shortcut Shift + Alt + I) to bring up a dialog where you provide information about the workflow to be distributed (see an example in figure 9.37).

Author information Providing name, email and organization of the author of the workflow. This will be visible for users installing the workflow and will enable them to look up the source of the workflow any time. The organization name is important because it is part of the workflow id (see more in section 9.2.4)

Workflow name The workflow name is based on the name used when saving the workflow in the **Navigation Area**. The workflow name is essential because it is used as part of the workflow

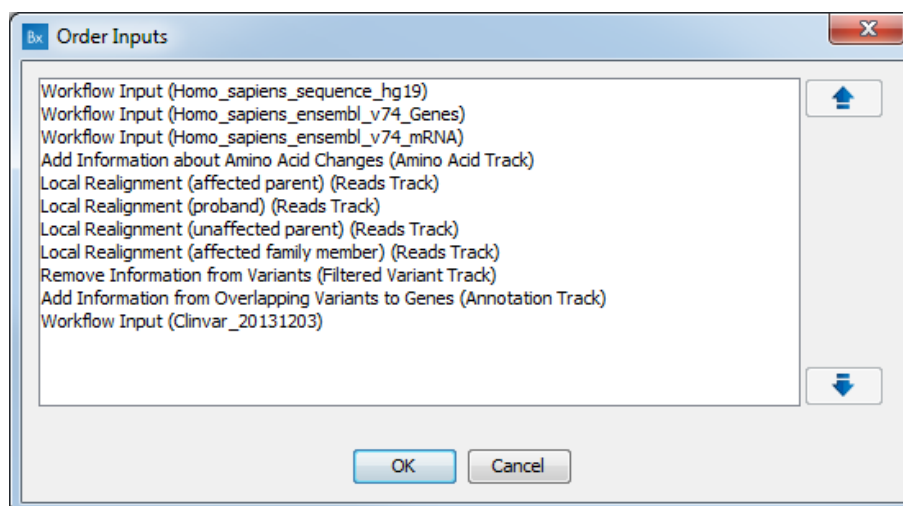

Figure 9.36: Example of Order Inputs window that appears when choosing the option "Order Inputs...".

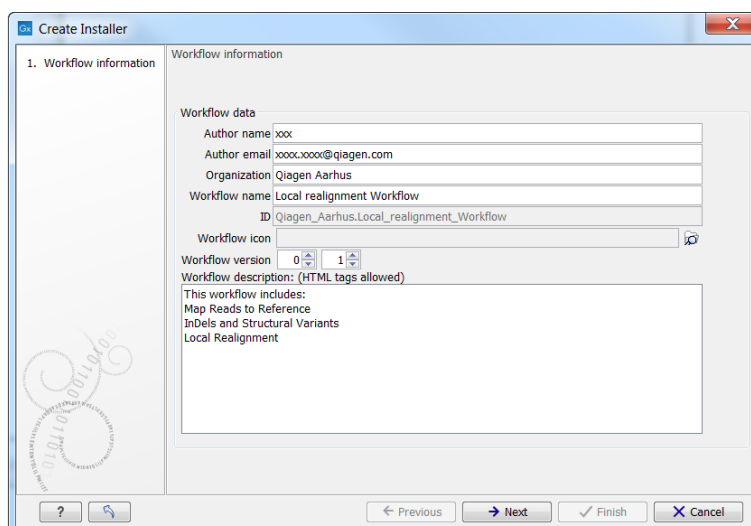

Figure 9.37: Workflow information for the installer.

id (see more in section 9.2.4). The workflow name can be changed during the installation of the workflow. This is useful whenever you have a workflow that you would like to use e.g. with small variations. The original workflow name will remain the same in the **Navigation Area** - only the installed workflow will receive the customized name.

ID The final id of the workflow.

Workflow icon An icon can be provided. This will show up in the installation overview and in the **Toolbox** once the workflow is installed. The icon should be a 16 x 16 pixels gif or png file. If the icon is larger, it will automatically be resized to fit 16 x 16 pixels.

Workflow version A major and minor version can be provided.

Include original workflow file This will include the design file to be included with the installer. Once the workflow is installed in a workbench, you can extract the original workflow file and modify it.

Workflow description Provide a textual description of the workflow. This information will be displayed when a user mouses-over the name of the installed Workflow in the Workbench Toolbox, and is also presented in the Description tab for that Workflow in the Manage Workflows tool, described in section 9.2.3. Simple HTML tags are allowed (should be HTML 3.1 compatible, see <http://www.w3.org/TR/REC-html32>).

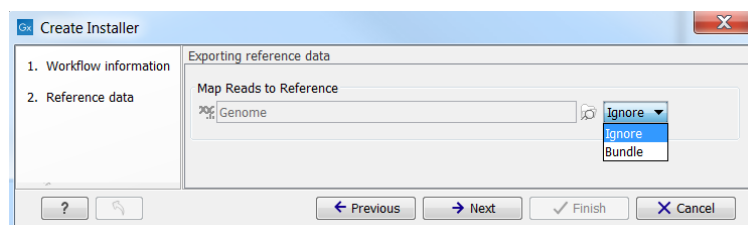

Figure 9.38: Bundling data with the workflow installer.

If you configured any of the workflow elements with data, clicking **Next** will give you the following options (see figure 9.38):

- **Ignore** This will exclude these reference data from the workflow.
- **Bundle** Includes data in the workflow by bundling the reference data with the workflow.
Note! Bundling data should only be used to bundle small data sets with the workflow installer.

Click **Next** and you will be asked to specify where to install the workflow (figure 9.39). You can install your workflow directly on your local computer. If you are logged on a server and are the administrator, the option "Install the workflow on the current server" will be enabled. Finally, you can select to save the workflow as a .cpw file that can be installed on another computer. Click **Finish**. This will install the workflow directly on the selected destination. If you have selected to save the workflow for installation on another computer, you will be asked where to save the file after clicking **Finish**. If you chose to bundle data with your workflow installation, you will be asked for a location to put the bundled data on the workbench. Installing a workflow with bundled data on a server, the data will be put in a folder created in the first writeable persistence location. Should this location not suit your needs, you can always move it afterwards, using the normal persistence operations.

In cases where an existing workflow, that has already been installed, is modified, the workflow must be reinstalled. This can be done by first saving the workflow after it has been modified and then pressing the **Create Installer** button. Click through the wizard and select whether you wish to install the modified workflow on your local computer or on a server. Press **Finish**. This will open a pop-up dialog "Workflow is already installed" (figure 9.40) with the option that you can force the installation. This will uninstall the existing workflow and install the modified version of the workflow. **Note!** When forcing installation of the modified workflow, the configuration of the original workflow will be lost.

9.2.2 Installing a workflow

Workflows are installed in the workflow manager (for information about installing a workflow on the CLC Genomics Server, please see the user manual at <http://www.qiagenbioinformatics.com/support/manuals/>):

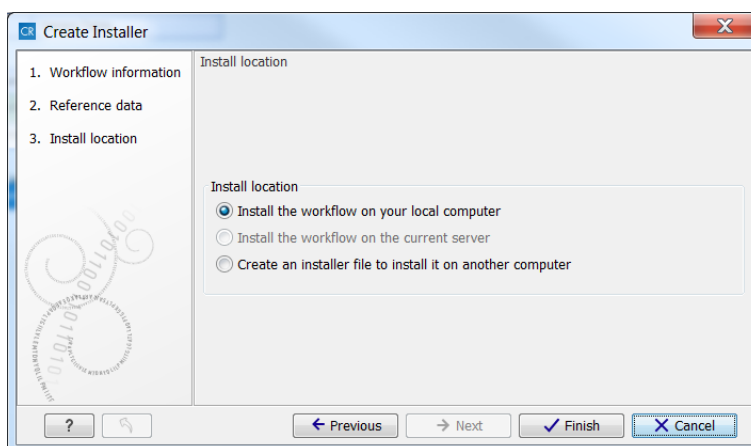

Figure 9.39: Select whether the workflow should be installed on your local computer or on the current server. A third option is to create an installer file (.cpw) that can be installed on another computer.

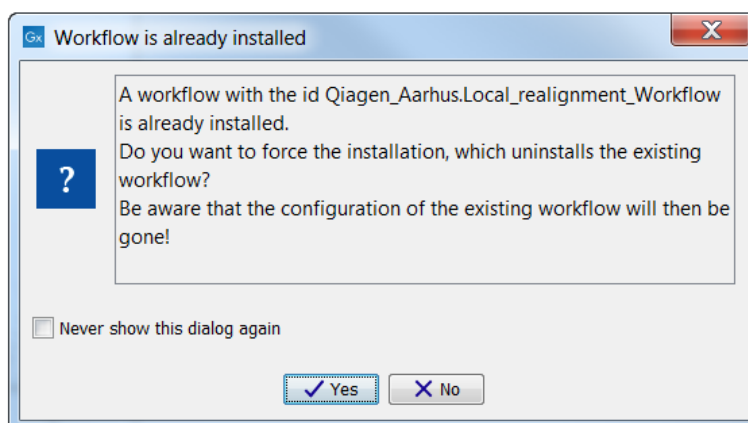

Figure 9.40: Select whether you wish to force the installation of the workflow or keep the original workflow.

Help | Manage Workflows (🔧)

or press the "Workflows" button (🔧) in the toolbar and then select "Manage Workflow..." (🔧).

This will display a dialog listing the installed workflows. To install an existing workflow, click **Install from File** and select a workflow .cpw file .

Once installed, it will appear in the workflow manager as shown in figure 9.41.

If the workflow was bundled with data, installing it on the workbench will ask you for a location to put the bundled data. Installing a workflow with bundled data on a server, the data will be put in a folder created in the first writeable persistence location.

9.2.3 Managing workflows

Workflows can be managed from the workflow manager:

Help | Manage Workflows (🔧)

or using the "Workflows" button (🔧) in the toolbar and then select "Manage Workflow..." (🔧).

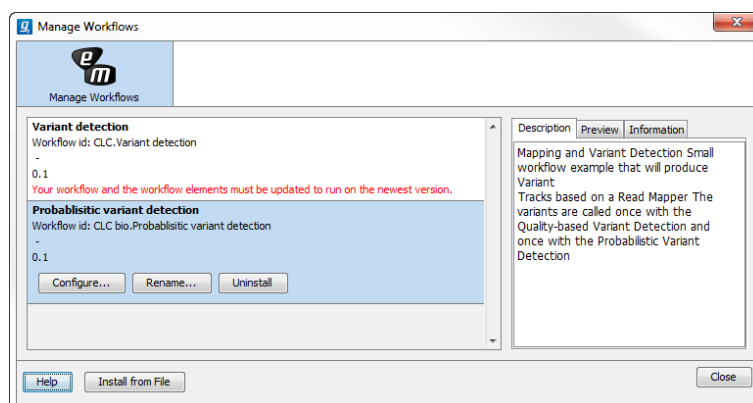

Figure 9.41: Workflows available in the workflow manager. Note the alert on the "Variant detection" workflow, that means that this workflow needs to be updated.

The workflow manager lists Custom workflows and Ready-to-Use workflows, but the functionalities described below (Configure, Rename, and Uninstall) are only available to custom workflows. You can always create a copy of a Ready-to-Use workflow (by opening the Ready-to-Use workflow and saving a copy in your Navigation Area) to enable the options described below.

Configure Select the workflow of interest and click on the button labeled Configure. You will be presented with a dialog listing all the reference data that need to be selected. An example is shown in figure 9.42.

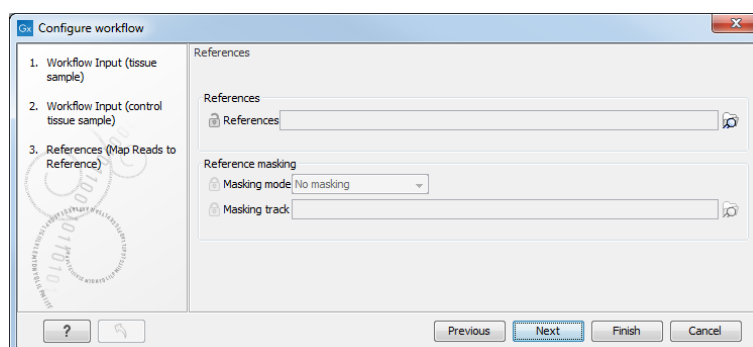

Figure 9.42: Configuring parameters for the workflow.

This dialog also allows you to lock parameters of the workflow (see more about locking in section 9.1.3).

Note that if the workflow is intended to be executed on a server, it is important to select reference data that is located on the server.

Rename In addition to the configuration option, it is also possible to rename the workflow. This will change the name of the workflow in the **Toolbox**. The workflow id (see below) remains the same. To rename an element right click on the element name in the Navigation Area and select "Rename" or click on the F2 button.

Uninstall Use this button to install a workflow.

Description, Preview and Information In the right side of the window, you will find three tabs. **Description** contains the description that was entered when creating the workflow installer (see figure 9.37), the **Preview** shows a graphical representation of the workflow (figure 9.43), and finally you can get **Information** about the workflow (figure 9.44).

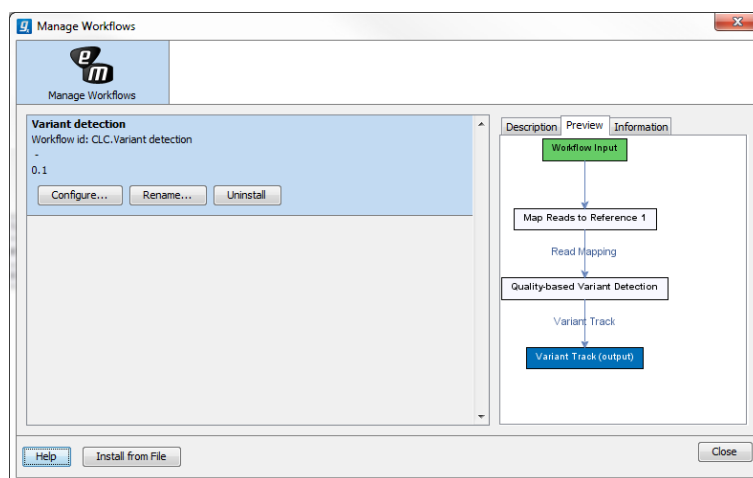

Figure 9.43: Preview of the workflow.

The "Information" field (figure 9.44) contains the following:

Build id The date followed by the time

Download href The name of the workflow .cpw file

Id The unique id of a workflow, by which the workflow is identified

Major version The major version of the workflow

Minor version The minor version of the workflow

Name Name of workflow

Rev version Revision version. The functionality is activated but currently not in use

Vendor id ID of vendor that has created the workflow

Version <Major version>.<Minor version>

Workbench api version Workbench version

Workflow api version Workflow version (a technical number that can be used for troubleshooting)

9.2.4 Workflow identification and versioning

A workflow has a version. The version is used to make it easy to distribute an improved version of the same workflow. To do this, create a new installer with an incremented version number. In order to install a new and updated version, the old one has to be uninstalled.

The way *CLC Genomics Workbench* checks whether a workflow already exists in a previous version is by looking at the workflow id. The id is a combination of the organization name

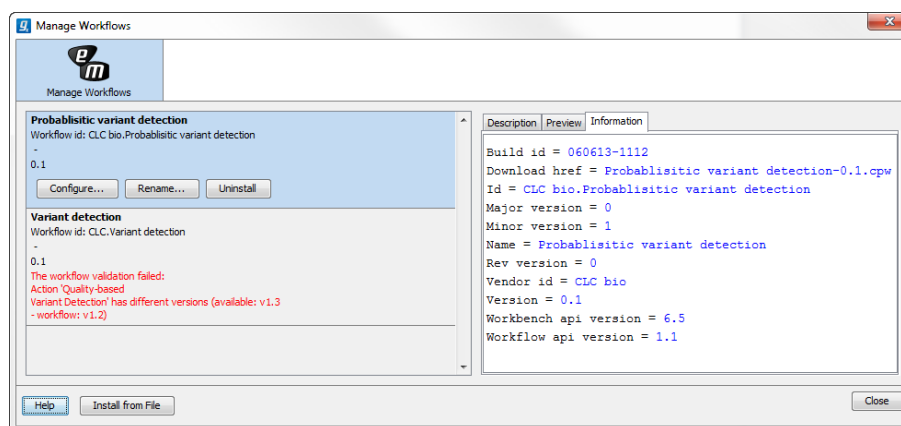

Figure 9.44: With "Manage Workflows" it is possible to configure, rename and uninstall workflows.

and the name of the workflow itself as it is shown in the dialog shown in figure 9.37. Once installed this information is also available in the workflow manager (in figure 9.41 this is CLC bio.Simple variant detection and annotation-1.2).

If you create two different workflows with the same name and using the same organization name when creating the installer, they cannot both be installed.

9.2.5 Automatic update of workflow elements

When new versions of the *CLC Genomics Workbench* are released, some of the tools that are part of a workflow may change. When this happens, the workflow may no longer be valid. This will happen both to the workflow configurations saved in the **Navigation Area** and the installed workflows.

When a workflow is opened from the **Navigation Area**, an editor will appear, if tools used in the workflow have been updated (see figure 9.45).

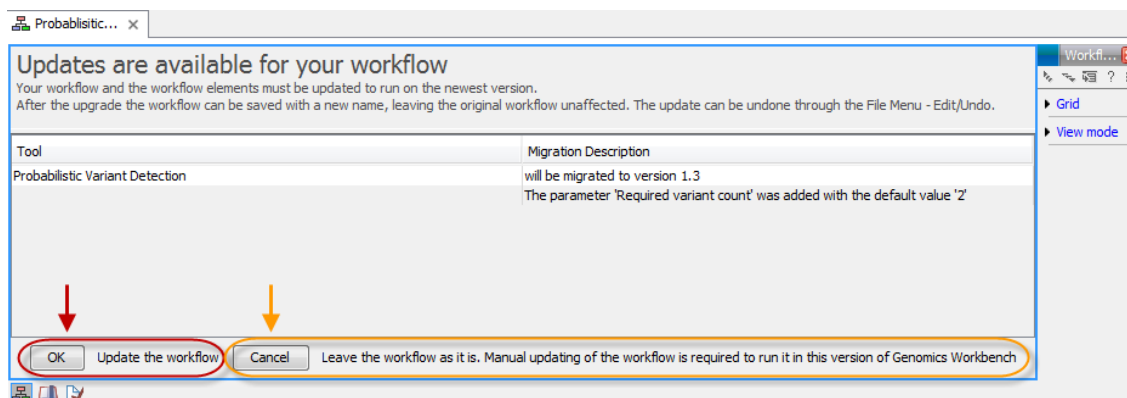

Figure 9.45: When updates are available an editor appears with information about which tools should be updated. Press "OK" to update the workflow. The workflow must be updated to be able to run the workflow on the newest version of the Workbench.

Updating a workflow means that the tools in your workflow is updated with the most recent version of these particular tools. To update your workflow, press the **OK** button at the bottom of the page.



There may be situations where it is important for you to keep the workflow in its original form.

This could be the case if you have used a workflow to generate results for a publication. In such cases it may be necessary for you to be able to go back to the original workflow to e.g. repeat an analysis.

You have two options to keep the old workflow:

- If you do not wish to update the workflow at all, press the **Cancel** button. This will keep the workflow unchanged. However, the next time you open the workflow, you will again be asked whether you wish to update the workflow. Please note that only updated workflows can run on the newest versions of the Workbench.
- Another option is to update the workflow and save the updated workflow with a new name. This will ensure that the old workflow is kept rather than being overwritten.

Note! In cases where new parameters have been added, these will be used with their default settings.

If you have used the toolbar "Workflow" button () and "Manage Workflow..." () to access a specific workflow in order to e.g. change the workflow configuration or are going to use the "Install from File" function, a button labeled "Update..." will appear whenever tools have been changed and the workflow needs to be updated (figure 9.46). When you click the button labeled "Update...", your workflow will be updated and the existing workflow will be overwritten.

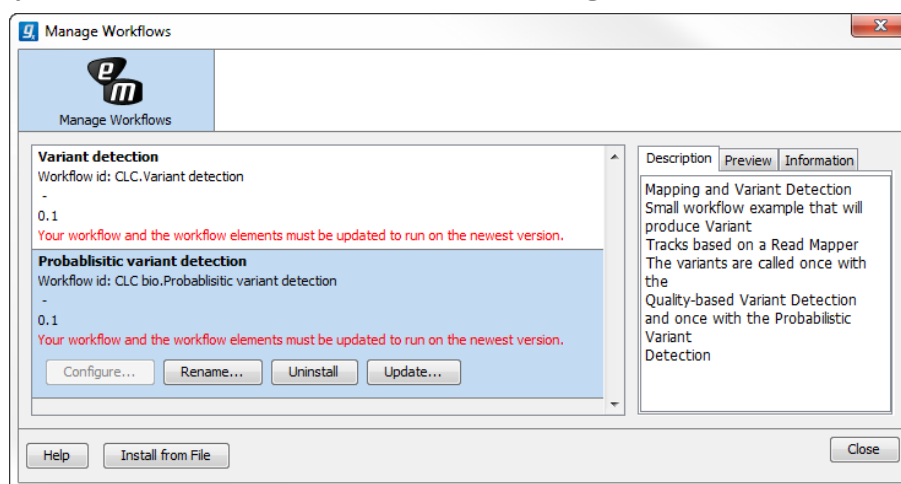



Figure 9.46: Workflow migration.

9.3 Executing a workflow

Once installed and configured, a workflow will appear in the **Toolbox** under **Workflows** (). If an icon was provided with the workflow installer this will also be shown (see figure 9.47).

The workflow is executed just as any other tool in the **Toolbox** by double-clicking or selecting it in the menu (or with the shortcut Ctrl + Enter). This will open a dialog where you provide input data and with options to run the workflow in batch mode (see section 8.3). In the last page of the dialog, you can preview all the parameters of the workflow, as well as the input data, before clicking "Next" to choose where to save the output, and then "Finish" to execute the workflow.

If you are connected to a *CLC Genomics Server*, you will be presented with the option to run the workflow locally on the Workbench or on the Server. When you are selecting where to run the work-

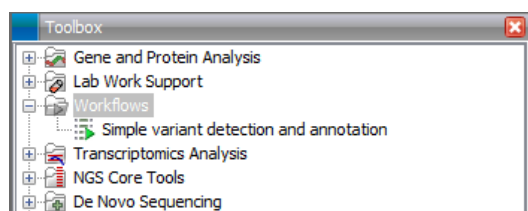

Figure 9.47: A workflow is installed and ready to be used.

flow, you should also see a message should there be any missing configurations. There are more details about running Workflows here: <http://resources.qiagenbioinformatics.com/manuals/clcgenomicsserver/current/admin/index.php?manual=Workflows.html>.

When the workflow is started, you can see the log file with detailed information from each step in the process.

If the workflow is not properly configured, you will see that in the dialog when the workflow is started ¹.

9.4 Open copy of installed workflow

A copy of an installed and configured workflow found in the **Toolbox** under **Workflows** (📁) can be opened in the View Area by clicking once and then right-clicking on the name of the installed workflow in the toolbox (figure 9.48).

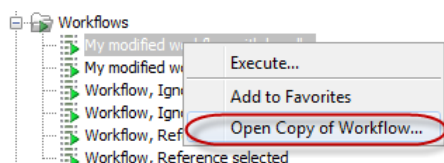

Figure 9.48: A copy of an installed workflow can be opened from the Toolbox. The copied workflow will open in the View Area.

An example of a copy of a workflow that has been opened in the **View Area** is shown in figure 9.49.

¹If the workflow uses a tool that is part of a plugin, a missing plugin can also be the reason why the workflow is not enabled. A workflow can also become outdated because the underlying tools have changed since the workflow was created (see section 9.2.4)

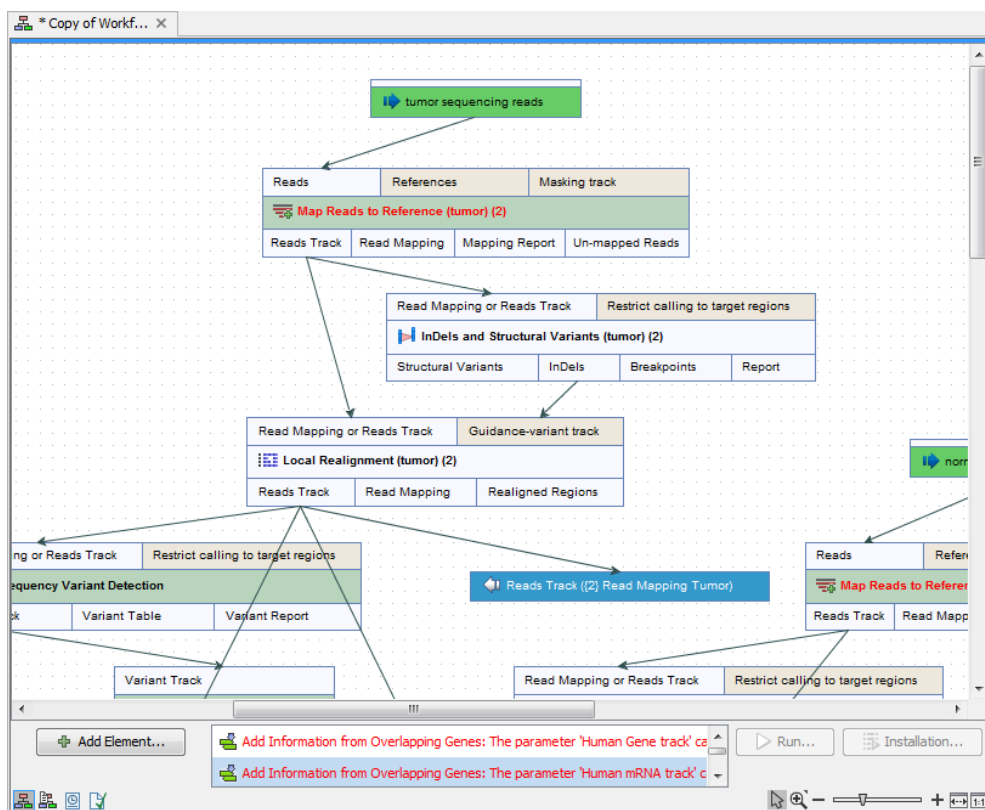

Figure 9.49: A copy of an installed workflow after it has been opened in the View Area.

Part III

Basic sequence analysis

Chapter 10

Viewing and editing sequences

Contents

10.1 View sequence	230
10.1.1 Sequence settings in Side Panel	231
10.1.2 Selecting parts of the sequence	237
10.1.3 Editing the sequence	238
10.1.4 Sequence region types	239
10.2 Circular DNA	239
10.2.1 Using split views to see details of the circular molecule	241
10.2.2 Mark molecule as circular and specify starting point	241
10.3 Working with annotations	241
10.3.1 Viewing annotations	242
10.3.2 Adding annotations	246
10.3.3 Edit annotations	248
10.3.4 Removing annotations	249
10.4 Element information	250
10.5 View as text	251
10.6 Sequence Lists	251

CLC Genomics Workbench offers five different ways of viewing and editing single sequences as described in the first five sections of this chapter. Furthermore, this chapter also explains how to create a new sequence and how to gather several sequences in a sequence list.

10.1 View sequence

When you double-click a sequence in the **Navigation Area**, the sequence will open automatically, and you will see the nucleotides or amino acids. The zoom options described in section 2.2 allow you to e.g. zoom out in order to see more of the sequence in one view. There are a number of options for viewing and editing the sequence which are all described in this section.

All the options described in this section also apply to alignments (further described in section 19.2).

10.1.1 Sequence settings in Side Panel

Each view of a sequence has a **Side Panel** located at the right side of the view (see figure 10.1).

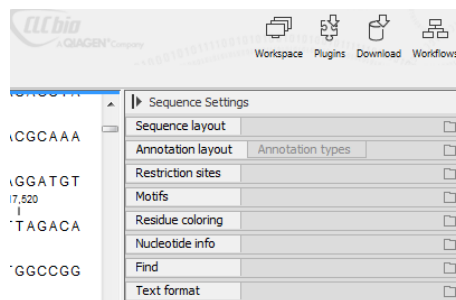

Figure 10.1: Overview of the Side Panel which is always shown to the right of a view.

When you make changes in the **Side Panel** the view of the sequence is instantly updated. To show or hide the **Side Panel**:

select the View | Ctrl + U

or **Click the (▶) at the top right corner of the Side Panel to hide | Click the (◀) to the right to show**

Below, each group of settings will be explained. Some of the preferences are not the same for nucleotide and protein sequences, but the differences will be explained for each group of settings.

Note! When you make changes to the settings in the **Side Panel**, they are not automatically saved when you save the sequence. Click **Save/restore Settings** (☰) to save the settings (see section 4.6 for more information).

Sequence Layout

These preferences determine the overall layout of the sequence:

- **Spacing.** Inserts a space at a specified interval:
 - **No spacing.** The sequence is shown with no spaces.
 - **Every 10 residues.** There is a space every 10 residues, starting from the beginning of the sequence.
 - **Every 3 residues, frame 1.** There is a space every 3 residues, corresponding to the reading frame starting at the first residue.
 - **Every 3 residues, frame 2.** There is a space every 3 residues, corresponding to the reading frame starting at the second residue.
 - **Every 3 residues, frame 3.** There is a space every 3 residues, corresponding to the reading frame starting at the third residue.
- **Wrap sequences.** Shows the sequence on more than one line.
 - **No wrap.** The sequence is displayed on one line.
 - **Auto wrap.** Wraps the sequence to fit the width of the view, not matter if it is zoomed in our out (displays minimum 10 nucleotides on each line).

- **Fixed wrap.** Makes it possible to specify when the sequence should be wrapped. In the text field below, you can choose the number of residues to display on each line.
- **Double stranded.** Shows both strands of a sequence (only applies to DNA sequences).
- **Numbers on sequences.** Shows residue positions along the sequence. The starting point can be changed by setting the number in the field below. If you set it to e.g. 101, the first residue will have the position of -100. This can also be done by right-clicking an annotation and choosing **Set Numbers Relative to This Annotation**.
- **Numbers on plus strand.** Whether to set the numbers relative to the positive or the negative strand in a nucleotide sequence (only applies to DNA sequences).
- **Lock numbers.** When you scroll vertically, the position numbers remain visible. (Only possible when the sequence is not wrapped.)
- **Lock labels.** When you scroll horizontally, the label of the sequence remains visible.
- **Sequence label.** Defines the label to the left of the sequence.
 - Name (this is the default information to be shown).
 - Accession (sequences downloaded from databases like GenBank have an accession number).
 - Latin name.
 - Latin name (accession).
 - Common name.
 - Common name (accession).
- **Matching residues as dots** Residues in aligned sequences identical to residues in the first (reference) sequence will be presented as dots. An option that is only available for "Alignments" and "Read mappings".

Annotation Layout and Annotation Types See section [10.3.1](#).

Restriction sites

See section [10.1.1](#).

Motifs

See section [13.9.1](#).

Residue coloring

These preferences make it possible to color both the residue letter and set a background color for the residue.

- **Non-standard residues.** For nucleotide sequences this will color the residues that are not C, G, A, T or U. For amino acids only B, Z, and X are colored as non-standard residues.

- **Foreground color.** Sets the color of the letter. Click the color box to change the color.
- **Background color.** Sets the background color of the residues. Click the color box to change the color.
- **Rasmol colors.** Colors the residues according to the Rasmol color scheme.
See <http://www.openrasmol.org/doc/rasmol.html>
 - **Foreground color.** Sets the color of the letter. Click the color box to change the color.
 - **Background color.** Sets the background color of the residues. Click the color box to change the color.
- **Polarity colors (only protein).** Colors the residues according to the following categories:
 - **Green** neutral, polar
 - **Black** neutral, nonpolar
 - **Red** acidic, polar
 - **Blue** basic ,polar
 - As with other options, you can choose to set or change the coloring for either the residue letter or its background:
 - * **Foreground color.** Sets the color of the letter. Click the color box to change the color.
 - * **Background color.** Sets the background color of the residues. Click the color box to change the color.
- **Trace colors (only DNA).** Colors the residues according to the color conventions of chromatogram traces: A=green, C=blue, G=black, and T=red.
 - **Foreground color.** Sets the color of the letter.
 - **Background color.** Sets the background color of the residues.

Nucleotide info

These preferences only apply to nucleotide sequences.

- **Color space encoding.** Lets you define a few settings for how the colors should appear.
 - Infer encoding** This is used if you want to display the colors for non-color space sequence (e.g. a reference sequence). The colors are then simply inferred from the sequence.
 - Show corrections** This is only relevant for mapping results - it will show where the mapping process has detected color errors.
 - Hide unaligned** This option determines whether color for the unaligned ends of reads should be displayed. It also controls whether colors should be shown for gaps. The idea behind this is that these color dots will interfere with the color alignment, so it is possible to turn them off.
- **Translation.** Displays a translation into protein just below the nucleotide sequence. Depending on the zoom level, the amino acids are displayed with three letters or one letter. In cases where variants are present in the reads, synonymous variants are shown in orange in the translated sequence whereas non-synonymous are shown in red.

- **Frame.** Determines where to start the translation.
 - * **ORF/CDS.** If the sequence is annotated, the translation will follow the CDS or ORF annotations. If annotations overlap, only one translation will be shown. If only one annotation is visible, the Workbench will attempt to use this annotation to mark the start and stop for the translation. In cases where this is not possible, the first annotation will be used (i.e. the one closest to the 5' end of the sequence).
 - * **Selection.** This option will only take effect when you make a selection on the sequence. The translation will start from the first nucleotide selected. Making a new selection will automatically display the corresponding translation. Read more about selecting in section [10.1.2](#).
 - * **+1 to -1.** Select one of the six reading frames.
 - * **All forward/All reverse.** Shows either all forward or all reverse reading frames.
 - * **All.** Select all reading frames at once. The translations will be displayed on top of each other.
- **Table.** The translation table to use in the translation. For more about translation tables, see section [14.5](#).
- **Only AUG start codons.** For most genetic codes, a number of codons can be start codons (TTG, CTG, or ATG). These will be colored green, unless selecting the "Only AUG start codons" option, which will result in only the AUG codons colored in green.
- **Single letter codes.** Choose to represent the amino acids with a single letter instead of three letters.
- **Trace data.** See section [17.1](#).
- **Quality scores.** For sequencing data containing quality scores, the quality score information can be displayed along the sequence.
 - **Show as probabilities.** Converts quality scores to error probabilities on a 0-1 scale, i.e. not log-transformed.
 - **Foreground color.** Colors the letter using a gradient, where the left side color is used for low quality and the right side color is used for high quality. The sliders just above the gradient color box can be dragged to highlight relevant levels. The colors can be changed by clicking the box. This will show a list of gradients to choose from.
 - **Background color.** Sets a background color of the residues using a gradient in the same way as described above.
 - **Graph.** The quality score is displayed on a graph (Learn how to export the data behind the graph in section [6.7](#)).
 - * **Height.** Specifies the height of the graph.
 - * **Type.** The graph can be displayed as Line plot, Bar plot or as a Color bar.
 - * **Color box.** For Line and Bar plots, the color of the plot can be set by clicking the color box. For Colors, the color box is replaced by a gradient color box as described under Foreground color.
- **G/C content.** Calculates the G/C content of a part of the sequence and shows it as a gradient of colors or as a graph below the sequence.

- **Window length.** Determines the length of the part of the sequence to calculate. A window length of 9 will calculate the G/C content for the nucleotide in question plus the 4 nucleotides to the left and the 4 nucleotides to the right. A narrow window will focus on small fluctuations in the G/C content level, whereas a wider window will show fluctuations between larger parts of the sequence.
- **Foreground color.** Colors the letter using a gradient, where the left side color is used for low levels of G/C content and the right side color is used for high levels of G/C content. The sliders just above the gradient color box can be dragged to highlight relevant levels of G/C content. The colors can be changed by clicking the box. This will show a list of gradients to choose from.
- **Background color.** Sets a background color of the residues using a gradient in the same way as described above.
- **Graph.** The G/C content level is displayed on a graph (Learn how to export the data behind the graph in section 6.7).
 - * **Height.** Specifies the height of the graph.
 - * **Type.** The graph can be displayed as Line plot, Bar plot or as a Color bar.
 - * **Color box.** For Line and Bar plots, the color of the plot can be set by clicking the color box. For Colors, the color box is replaced by a gradient color box as described under Foreground color.
- **Secondary structure.** Allows you to choose how to display a symbolic representation of the secondary structure along the sequence. See section 21.2.3 for a detailed description of the settings.

Protein info

These preferences only apply to proteins. The first nine items are different hydrophobicity scales. These are described in section 15.5.2.

- **Kyte-Doolittle.** The Kyte-Doolittle scale is widely used for detecting hydrophobic regions in proteins. Regions with a positive value are hydrophobic. This scale can be used for identifying both surface-exposed regions as well as transmembrane regions, depending on the window size used. Short window sizes of 5-7 generally work well for predicting putative surface-exposed regions. Large window sizes of 19-21 are well suited for finding transmembrane domains if the values calculated are above 1.6 [Kyte and Doolittle, 1982]. These values should be used as a rule of thumb and deviations from the rule may occur.
- **Cornette.** Cornette *et al.* computed an optimal hydrophobicity scale based on 28 published scales [Cornette *et al.*, 1987]. This optimized scale is also suitable for prediction of alpha-helices in proteins.
- **Engelman.** The Engelman hydrophobicity scale, also known as the GES-scale, is another scale which can be used for prediction of protein hydrophobicity [Engelman *et al.*, 1986]. As the Kyte-Doolittle scale, this scale is useful for predicting transmembrane regions in proteins.
- **Eisenberg.** The Eisenberg scale is a normalized consensus hydrophobicity scale which shares many features with the other hydrophobicity scales [Eisenberg *et al.*, 1984].

- **Rose.** The hydrophobicity scale by Rose *et al.* is correlated to the average area of buried amino acids in globular proteins [Rose *et al.*, 1985]. This results in a scale which is not showing the helices of a protein, but rather the surface accessibility.
- **Janin.** This scale also provides information about the accessible and buried amino acid residues of globular proteins [Janin, 1979].
- **Hopp-Woods.** Hopp and Woods developed their hydrophobicity scale for identification of potentially antigenic sites in proteins. This scale is basically a hydrophilic index where apolar residues have been assigned negative values. Antigenic sites are likely to be predicted when using a window size of 7 [Hopp and Woods, 1983].
- **Welling.** [Welling *et al.*, 1985] Welling *et al.* used information on the relative occurrence of amino acids in antigenic regions to make a scale which is useful for prediction of antigenic regions. This method is better than the Hopp-Woods scale of hydrophobicity which is also used to identify antigenic regions.
- **Kolaskar-Tongaonkar.** A semi-empirical method for prediction of antigenic regions has been developed [Kolaskar and Tongaonkar, 1990]. This method also includes information of surface accessibility and flexibility and at the time of publication the method was able to predict antigenic determinants with an accuracy of 75%.
- **Surface Probability.** Display of surface probability based on the algorithm by [Emini *et al.*, 1985]. This algorithm has been used to identify antigenic determinants on the surface of proteins.
- **Chain Flexibility.** Display of backbone chain flexibility based on the algorithm by [Karplus and Schulz, 1985]. It is known that chain flexibility is an indication of a putative antigenic determinant.

Find

The Find function can be used for searching the sequence and is invoked by pressing Ctrl + Shift + F (⌘ + Shift + F on Mac). Initially, specify the 'search term' to be found, select the type of search (see various options in the following) and finally click on the Find button. The first occurrence of the search term will then be highlighted. Clicking the find button again will find the next occurrence and so on. If the search string is found, the corresponding part of the sequence will be selected.

- **Search term.** Enter the text or number to search for. The search function does not discriminate between lower and upper case characters.
- **Sequence search.** Search the nucleotides or amino acids. For amino acids, the single letter abbreviations should be used for searching. The sequence search also has a set of advanced search parameters:
 - Include negative strand. This will search on the negative strand as well.
 - Treat ambiguous characters as wildcards in search term. If you search for e.g. ATN, you will find both ATG and ATC. If you wish to find literally exact matches for ATN (i.e. only find ATN - not ATG), this option should not be selected.

- Treat ambiguous characters as wildcards in sequence. If you search for e.g. ATG, you will find both ATG and ATN. If you have large regions of Ns, this option should not be selected.

Note that if you enter a position instead of a sequence, it will automatically switch to position search.

- **Annotation search.** Searches the annotations on the sequence. The search is performed both on the labels of the annotations, but also on the text appearing in the tooltip that you see when you keep the mouse cursor fixed. If the search term is found, the part of the sequence corresponding to the matching annotation is selected. Below this option you can choose to search for translations as well. Sequences annotated with coding regions often have the translation specified which can lead to undesired results.
- **Position search.** Finds a specific position on the sequence. In order to find an interval, e.g. from position 500 to 570, enter "500..570" in the search field. This will make a selection from position 500 to 570 (both included). Notice the two periods (..) between the start and end number. If you enter positions including thousands separators like 123,345, the comma will just be ignored and it would be equivalent to entering 123345.
- **Include negative strand.** When searching the sequence for nucleotides or amino acids, you can search on both strands.
- **Name search.** Searches for sequence names. This is useful for searching sequence lists and mapping results for example.

This concludes the description of the **View Preferences**. Next, the options for selecting and editing sequences are described.

Text format

These preferences allow you to adjust the format of all the text in the view (both residue letters, sequence name and translations if they are shown).

- **Text size.** Five different sizes.
- **Font.** Shows a list of Fonts available on your computer.
- **Bold residues.** Makes the residues bold.

Restriction sites in the Side Panel

Please see section [18.3.1](#).

10.1.2 Selecting parts of the sequence

You can select parts of a sequence:

Click Selection () in Toolbar | Press and hold down the mouse button on the sequence where you want the selection to start | move the mouse to the end of the selection while holding the button | release the mouse button

Alternatively, you can search for a specific interval using the find function described above.

If you have made a selection and wish to adjust it:

drag the edge of the selection (you can see the mouse cursor change to a horizontal arrow

or **press and hold the Shift key while using the right and left arrow keys to adjust the right side of the selection.**

If you wish to select the entire sequence:

double-click the sequence name to the left

Selecting several parts at the same time (multiselect)

You can select several parts of sequence by holding down the **Ctrl** button while making selections. Holding down the **Shift** button lets you extend or reduce an existing selection to the position you clicked.

To select a part of a sequence covered by an annotation:

right-click the annotation | Select annotation

or **double-click the annotation**

To select a fragment between two restriction sites that are shown on the sequence:

double-click the sequence between the two restriction sites

(Read more about restriction sites in section [10.1.1.](#))

Open a selection in a new view

A selection can be opened in a new view and saved as a new sequence:

right-click the selection | Open selection in New View 

This opens the annotated part of the sequence in a new view. The new sequence can be saved by dragging the tab of the sequence view into the **Navigation Area**.

The process described above is also the way to manually translate coding parts of sequences (CDS) into protein. You simply translate the new sequence into protein. This is done by:

right-click the tab of the new sequence | Toolbox | Classical Sequence Analysis
( | Nucleotide Analysis ()| Translate to Protein ()

A selection can also be copied to the clipboard and pasted into another program:

make a selection | Ctrl + C ( + C on Mac)

Note! The annotations covering the selection will not be copied.

A selection of a sequence can be edited as described in the following section.

10.1.3 Editing the sequence

When you make a selection, it can be edited by:

right-click the selection | Edit Selection (✎)

A dialog appears displaying the sequence. You can add, remove or change the text and click **OK**. The original selected part of the sequence is now replaced by the sequence entered in the dialog. This dialog also allows you to paste text into the sequence using Ctrl + V (⌘ + V on Mac).

If you delete the text in the dialog and press **OK**, the selected text on the sequence will also be deleted. Another way to delete a part of the sequence is to:

right-click the selection | Delete Selection (✂)

If you wish to correct only one residue, this is possible by simply making the selection cover only one residue and then type the new residue. Another way to edit the sequence is by inserting a restriction site. See section 18.1.4.

Note When editing annotated nucleotide sequences, the annotation content is not updated automatically (but its position is). Please refer to section 10.3.3 for details on annotation editing.

Before exporting annotated nucleotide sequences in GenBank format, ensure that the annotations in the Annotations Table reflect the edits that have been made to the sequence.

10.1.4 Sequence region types

The various annotations on sequences cover parts of the sequence. Some cover an interval, some cover intervals with unknown endpoints, some cover more than one interval etc. In the following, all of these will be referred to as *regions*. Regions are generally illustrated by markings (often arrows) on the sequences. An arrow pointing to the right indicates that the corresponding region is located on the positive strand of the sequence. Figure 10.2 is an example of three regions with separate colors.

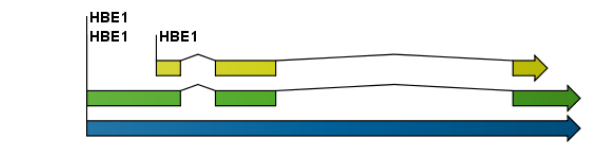

Figure 10.2: Three regions on a human beta globin DNA sequence (HUMHBB).

Figure 10.3 shows an artificial sequence with all the different kinds of regions.

10.2 Circular DNA

A sequence can be shown as a circular molecule:

Select a sequence in the Navigation Area and right-click on the file name | Hold the mouse over "Show" to enable a list of options | Select "Circular View" (🔄)

or **If the sequence is already open | Click "Show Circular View"** (🔄) at the lower left part of the view

This will open a view of the molecule similar to the one in figure 10.4.

This view of the sequence shares some of the properties of the linear view of sequences as described in section 10.1, but there are some differences. The similarities and differences are listed below:

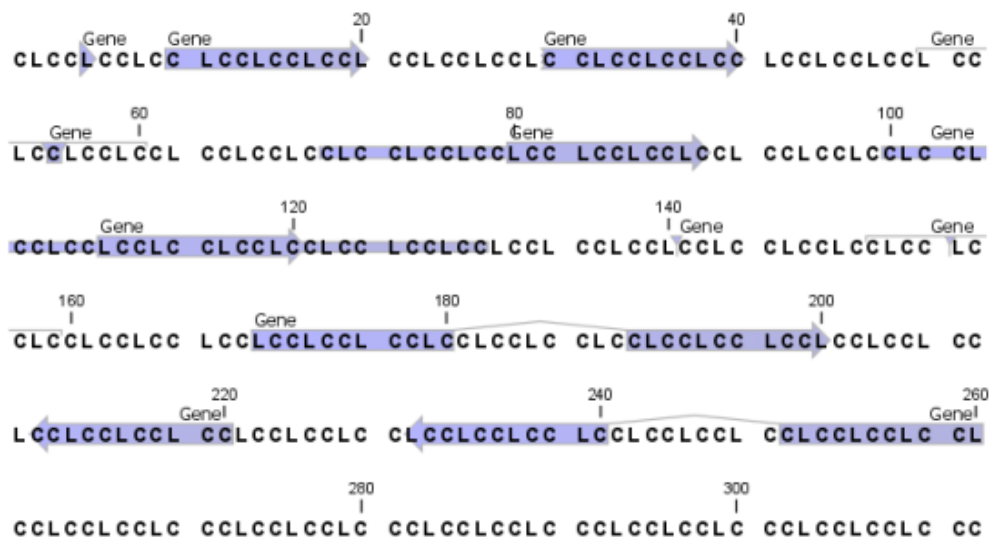

Figure 10.3: *Region #1: A single residue, Region #2: A range of residues including both endpoints, Region #3: A range of residues starting somewhere before 30 and continuing up to and including 40, Region #4: A single residue somewhere between 50 and 60 inclusive, Region #5: A range of residues beginning somewhere between 70 and 80 inclusive and ending at 90 inclusive, Region #6: A range of residues beginning somewhere between 100 and 110 inclusive and ending somewhere between 120 and 130 inclusive, Region #7: A site between residues 140 and 141, Region #8: A site between two residues somewhere between 150 and 160 inclusive, Region #9: A region that covers ranges from 170 to 180 inclusive and 190 to 200 inclusive, Region #10: A region on negative strand that covers ranges from 210 to 220 inclusive, Region #11: A region on negative strand that covers ranges from 230 to 240 inclusive and 250 to 260 inclusive.*

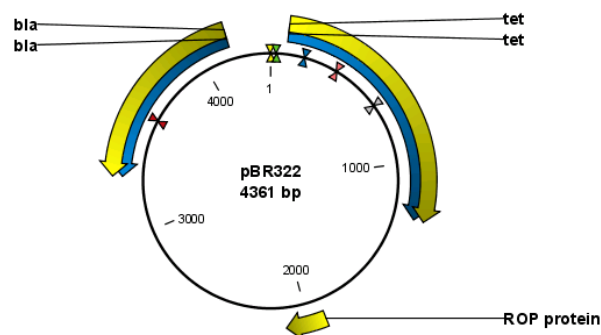

Figure 10.4: *A molecule shown in a circular view.*

- **Similarities:**

- The editing options.
- Options for adding, editing and removing annotations.
- **Restriction Sites, Annotation Types, Find and Text Format** preferences groups.

- **Differences:**

- In the **Sequence Layout** preferences, only the following options are available in the circular view: **Numbers on plus strand, Numbers on sequence** and **Sequence label**.
- You cannot zoom in to see the residues in the circular molecule. If you wish to see these details, split the view with a linear view of the sequence

- In the **Annotation Layout**, you also have the option of showing the labels as **Stacked**. This means that there are no overlapping labels and that all labels of both annotations and restriction sites are adjusted along the left and right edges of the view.

10.2.1 Using split views to see details of the circular molecule

In order to see the nucleotides of a circular molecule you can open a new view displaying a circular view of the molecule:

Press and hold the Ctrl button (⌘ on Mac) | click Show Sequence (📄) at the bottom of the view

This will open a linear view of the sequence below the circular view. When you zoom in on the linear view you can see the residues as shown in figure 10.5.

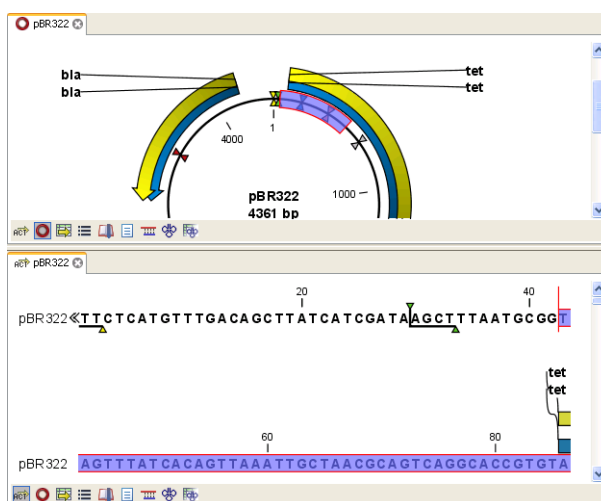

Figure 10.5: Two views showing the same sequence. The bottom view is zoomed in.

Note! If you make a selection in one of the views, the other view will also make the corresponding selection, providing an easy way for you to focus on the same region in both views.

10.2.2 Mark molecule as circular and specify starting point

You can mark a DNA molecule as circular by right-clicking its name in either the sequence view or the circular view. In the right-click menu you can also make a circular molecule linear. A circular molecule displayed in the normal sequence view, will have the sequence ends marked with a $\overline{\text{c}}$.

The starting point of a circular sequence can be changed by:

make a selection starting at the position that you want to be the new starting point | right-click the selection | Move Starting Point to Selection Start

Note! This can only be done for sequence that have been marked as circular.

10.3 Working with annotations

Annotations provide information about specific regions of a sequence. A typical example is the annotation of a gene on a genomic DNA sequence.

Annotations derive from different sources:

- Sequences downloaded from databases like GenBank are annotated.
- In some of the data formats that can be imported into *CLC Genomics Workbench*, sequences can have annotations (GenBank, EMBL and Swiss-Prot format).
- The result of a number of analyses in *CLC Genomics Workbench* are annotations on the sequence (e.g. finding open reading frames and restriction map analysis).
- A protein structure can be linked with a sequence (section 12.5.2), and atom groups defined on the structure transferred to sequence annotations or vica versa (section 12.5.3).
- You can manually add annotations to a sequence (described in the section 10.3.2).

If you would like to extract parts of a sequence (or several sequences) based on its annotations, you can find a description of how to do this in section 13.1.

Note! Annotations are included if you export the sequence in GenBank, Swiss-Prot, EMBL or CLC format. When exporting in other formats, annotations are not preserved in the exported file.

10.3.1 Viewing annotations

Annotations can be viewed in a number of different ways:

- As arrows or boxes in all views displaying sequences (sequence lists, alignments etc)
- In the table of annotations (📄➡).
- In the text view of sequences (☰).

In the following sections, these view options will be described in more detail. In all the views except the text view (☰), annotations can be added, modified and deleted. This is described in the following sections.

View Annotations in sequence views

Figure 10.6 shows an annotation displayed on a sequence.

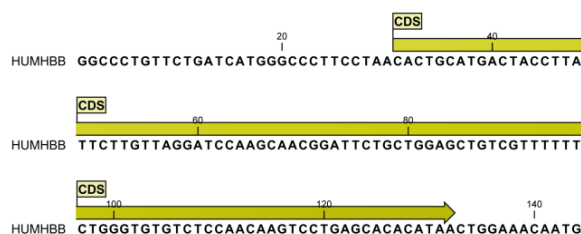

Figure 10.6: An annotation showing a coding region on a genomic dna sequence.

The various sequence views listed in section 10.3.1 have different default settings for showing annotations. However, they all have two groups in the **Side Panel** in common:

- **Annotation Layout**
- **Annotation Types**

The two groups are shown in figure 10.7.

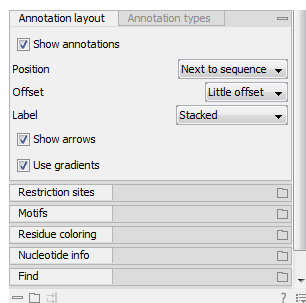

Figure 10.7: The annotation layout in the Side Panel. The annotation types can be shown by clicking on the "Annotation types" tab.

In the **Annotation layout** group, you can specify how the annotations should be displayed (notice that there are some minor differences between the different sequence views):

- **Show annotations.** Determines whether the annotations are shown.
- **Position.**
 - **On sequence.** The annotations are placed on the sequence. The residues are visible through the annotations (if you have zoomed in to 100%).
 - **Next to sequence.** The annotations are placed above the sequence.
 - **Separate layer.** The annotations are placed above the sequence and above restriction sites (only applicable for nucleotide sequences).
- **Offset.** If several annotations cover the same part of a sequence, they can be spread out.
 - **Piled.** The annotations are piled on top of each other. Only the one at front is visible.
 - **Little offset.** The annotations are piled on top of each other, but they have been offset a little.
 - **More offset.** Same as above, but with more spreading.
 - **Most offset.** The annotations are placed above each other with a little space between. This can take up a lot of space on the screen.
- **Label.** The name of the annotation can shown as a label. Additional information about the sequence is shown if you place the mouse cursor on the annotation and keep it still.
 - **No labels.** No labels are displayed.
 - **On annotation.** The labels are displayed in the annotation's box.
 - **Over annotation.** The labels are displayed above the annotations.
 - **Before annotation.** The labels are placed just to the left of the annotation.
 - **Flag.** The labels are displayed as flags at the beginning of the annotation.
 - **Stacked.** The labels are offset so that the text of all labels is visible. This means that there is varying distance between each sequence line to make room for the labels.

- **Show arrows.** Displays the end of the annotation as an arrow. This can be useful to see the orientation of the annotation (for DNA sequences). Annotations on the negative strand will have an arrow pointing to the left.
- **Use gradients.** Fills the boxes with gradient color.

In the **Annotation types** group, you can choose which kinds of annotations that should be displayed. This group lists all the types of annotations that are attached to the sequence(s) in the view. For sequences with many annotations, it can be easier to get an overview if you deselect the annotation types that are not relevant.

Unchecking the checkboxes in the **Annotation layout** will not remove this type of annotations from the sequence - it will just hide them from the view.

Besides selecting which types of annotations that should be displayed, the **Annotation types** group is also used to change the color of the annotations on the sequence. Click the colored square next to the relevant annotation type to change the color.

This will display a dialog with five tabs: Swatches, HSB, HSI, RGB, and CMYK. They represent five different ways of specifying colors. Apply your settings and click **OK**. When you click **OK**, the color settings cannot be reset. The **Reset** function only works for changes made before pressing **OK**.

Furthermore, the **Annotation types** can be used to easily browse the annotations by clicking the small button (▾) next to the type. This will display a list of the annotations of that type (see figure 10.8).

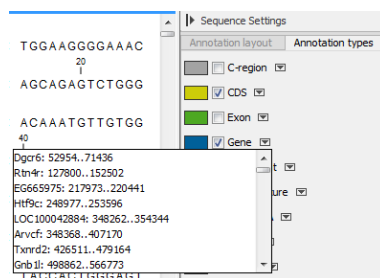

Figure 10.8: Browsing the gene annotations on a sequence.

Clicking an annotation in the list will select this region on the sequence. In this way, you can quickly find a specific annotation on a long sequence.

Note: A waved end on an annotation (figure 10.9) means that the annotation is torn, i.e., it extends beyond the sequence displayed. An annotation can be torn when a new, smaller sequence has been created from a larger sequence. A common example of this situation is when you select a section of a stand alone sequence and open it in a new view. If there are annotations present within this selected region that extend beyond the selection, then the selected sequence shown in the new view will exhibit these torn annotations.

View Annotations in a table

Annotations can also be viewed in a table:

Select a sequence in the Navigation Area and right-click on the file name | Hold the mouse over "Show" to enable a list of options | Annotation Table (📄)

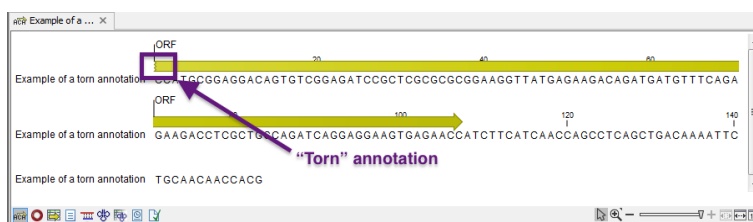

Figure 10.9: Example of a torn annotation on a sequence.

or **If the sequence is already open | Click Show Annotation Table** () **at the lower left part of the view**

This will open a view similar to the one in figure 10.10).

Name	Type	Region	Qualifiers
Atp8a1	Gene	1..228194	/gene=Atp8a1 /note=Derived by automated computational analysis using gene prediction method: BestRefseq. Supporting evidence includes similarity to: 2 mRNAs /db_xref="GeneID:11980" /db_xref="MGI:1330848
Atp8a1	CDS	join(222..270,32851..32...	/gene=Atp8a1 /GO_component=integral to membrane; membrane /GO_function=ATP binding; ATPase activity; ATPase activity, coupled to transmembrane movement of ions; phosphorylative mechanism; catalytic activity; hydrolase activity; hydrolase activity, acting on acid anhydrides; catalyzing transmembrane movement of substances; magnesium ion binding; metal ion binding; nucleotide binding; phospholipid-translocating ATPase activity /GO_process=cation transport; metabolism /note=isoform b is encoded by transcript variant 2; ATPase 8A1, p... http://ATPase_8A1_cationphospholipid

Figure 10.10: A table showing annotations on the sequence.

In the **Side Panel** you can show or hide individual annotation types in the table. E.g. if you only wish to see "gene" annotations, de-select the other annotation types so that only "gene" is selected.

Each row in the table is an annotation which is represented with the following information:

- **Name.**
- **Type.**
- **Region.**
- **Qualifiers.**

The Name, Type and Region for each annotation can be edited simply by double-clicking, typing the change directly, and pressing **Enter**.

This information corresponds to the information in the dialog when you edit and add annotations (see section 10.3.2).

You can benefit from this table in several ways:

- It provides an intelligible overview of all the annotations on the sequence.
- You can use the filter at the top to search the annotations. Type e.g. "UCP" into the filter and you will find all annotations which have "UCP" in either the name, the type, the region or the qualifiers. Combined with showing or hiding the annotation types in the **Side Panel**, this makes it easy to find annotations or a subset of annotations.
- You can copy and paste annotations, e.g. from one sequence to another.
- If you wish to edit many annotations consecutively, the double-click editing makes this very fast (see section 10.3.2).

10.3.2 Adding annotations

Adding annotations to a sequence can be done in two ways:

Open the sequence in a sequence view (double-click in the Navigation Area) | make a selection covering the part of the sequence you want to annotate¹ | right-click the selection | Add Annotation (👉)

or **Select a sequence in the Navigation Area and right-click on the file name | Hold the mouse over "Show" to enable a list of options | Annotation table (👉) | right click anywhere in the annotation table | select Add Annotation (👉)**

This will display a dialog like the one in figure 10.11.

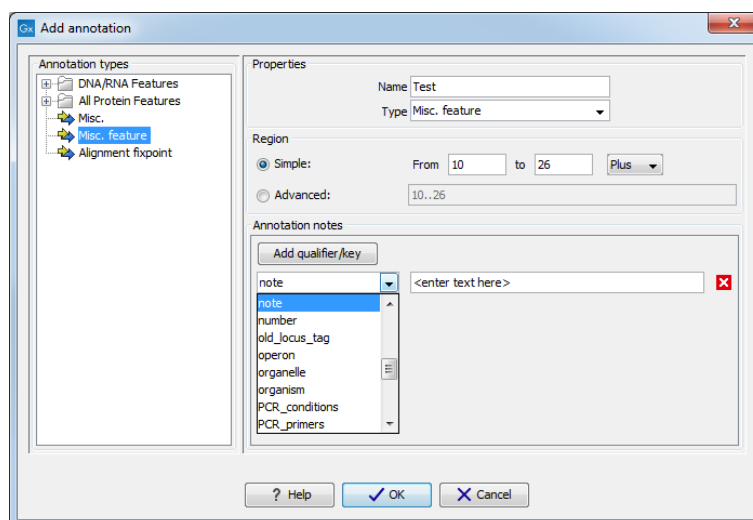

Figure 10.11: The Add Annotation dialog.

The left-hand part of the dialog lists a number of **Annotation types**. When you have selected an annotation type, it appears in **Type** to the right. You can also select an annotation directly in this list. Choosing an annotation type is mandatory. If you wish to use an annotation type which is not present in the list, simply enter this type into the **Type** field ².

The right-hand part of the dialog contains the following text fields:

²Note that your own annotation types will be converted to "unsure" when exporting in GenBank format. As long as you use the sequence in CLC format, you own annotation type will be preserved

- **Name.** The name of the annotation which can be shown on the label in the sequence views. (Whether the name is actually shown depends on the **Annotation Layout** preferences, see section 10.3.1).
- **Type.** Reflects the left-hand part of the dialog as described above. You can also choose directly in this list or type your own annotation type.
- **Region.** If you have already made a selection, this field will show the positions of the selection. You can modify the region further using the conventions of DDBJ, EMBL and GenBank. The following are examples of how to use the syntax (based on <http://www.ncbi.nlm.nih.gov/collab/FT/>):
 - **467.** Points to a single residue in the presented sequence.
 - **340..565.** Points to a continuous range of residues bounded by and including the starting and ending residues.
 - **<345..500.** Indicates that the exact lower boundary point of a region is unknown. The location begins at some residue previous to the first residue specified (which is not necessarily contained in the presented sequence) and continues up to and including the ending residue.
 - **<1..888.** The region starts before the first sequenced residue and continues up to and including residue 888.
 - **1..>888.** The region starts at the first sequenced residue and continues beyond residue 888.
 - **(102.110).** Indicates that the exact location is unknown, but that it is one of the residues between residues 102 and 110, inclusive.
 - **123^124.** Points to a site between residues 123 and 124.
 - **join(12..78,134..202).** Regions 12 to 78 and 134 to 202 should be joined to form one contiguous sequence.
 - **complement(34..126)** Start at the residue complementary to 126 and finish at the residue complementary to residue 34 (the region is on the strand complementary to the presented strand).
 - **complement(join(2691..4571,4918..5163)).** Joins regions 2691 to 4571 and 4918 to 5163, then complements the joined segments (the region is on the strand complementary to the presented strand).
 - **join(complement(4918..5163),complement(2691..4571)).** Complements regions 4918 to 5163 and 2691 to 4571, then joins the complemented segments (the region is on the strand complementary to the presented strand).
- **Annotations.** In this field, you can add more information about the annotation like comments and links. Click the **Add qualifier/key** button to enter information. Select a qualifier which describes the kind of information you wish to add. If an appropriate qualifier is not present in the list, you can type your own qualifier. The pre-defined qualifiers are derived from the GenBank format. You can add as many qualifier/key lines as you wish by clicking the button. Redundant lines can be removed by clicking the delete icon (✖). The information entered on these lines is shown in the annotation table (see section 10.3.1) and in the yellow box which appears when you place the mouse cursor on the annotation. If you write a hyperlink in the **Key** text field, like e.g. "www.clcbio.com", it will be recognized as a hyperlink. Clicking the link in the annotation table will open a web browser.

Click **OK** to add the annotation.

Note! The annotation will be included if you export the sequence in GenBank, Swiss-Prot or CLC format. When exporting in other formats, annotations are not preserved in the exported file.

10.3.3 Edit annotations

To edit an existing annotation from within a sequence view:

right-click the annotation | Edit Annotation (👉)

This will show the same dialog as in figure 10.11, with the exception that some of the fields are filled out depending on how much information the annotation contains.

There is another way of quickly editing annotations which is particularly useful when you wish to edit several annotations.

To edit the information, simply double-click and you will be able to edit e.g. the name or the annotation type. If you wish to edit the qualifiers and double-click in this column, you will see the dialog for editing annotations.

Advanced editing of annotations

Sometimes you end up with annotations which do not have a meaningful name. In that case there is an advanced batch rename functionality:

Open the Annotation Table (👉) | select the annotations that you want to rename | right-click the selection | Advanced Rename

This will bring up the dialog shown in figure 10.12.

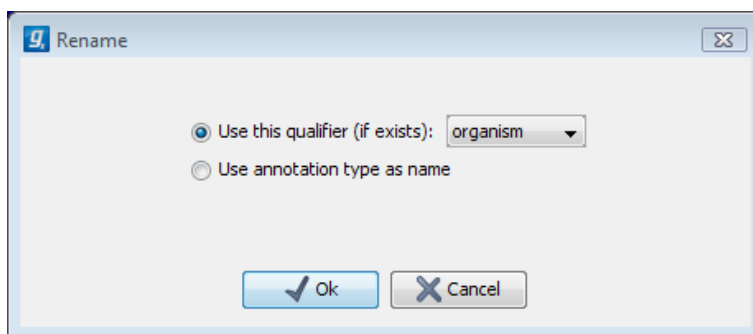

Figure 10.12: *The Advanced Rename dialog.*

In this dialog, you have two options:

- **Use this qualifier.** Use one of the qualifiers as name. A list of all qualifiers of all the selected annotations is shown. Note that if one of the annotations do not have the qualifier you have chosen, it will not be renamed. If an annotation has multiple qualifiers of the same type, the first is used for naming.
- **Use annotation type as name.** The annotation's type will be used as name (e.g. if you have an annotation of type "Promoter", it will get "Promoter" as its name by using this option).

A similar functionality for batch re-typing annotations is available in the right-click menu as well, in case your annotations are not typed correctly:

Open the Annotation Table (👉) | select the annotations that you want to retype | right-click the selection | Advanced Retype

This will bring up the dialog shown in figure 10.13.

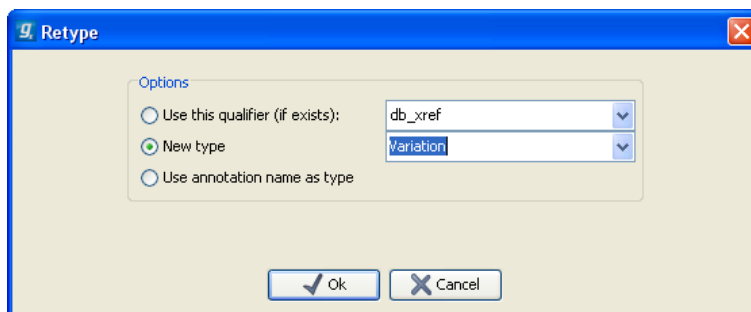

Figure 10.13: The Advanced Retype dialog.

In this dialog, you have two options:

- **Use this qualifier.** Use one of the qualifiers as type. A list of all qualifiers of all the selected annotations is shown. Note that if one of the annotations do not have the qualifier you have chosen, it will not be retyped. If an annotation has multiple qualifiers of the same type, the first is used for the new type.
- **New type.** You can select from a list of all the pre-defined types as well as enter your own annotation type. All the selected annotations will then get this type.
- **Use annotation name as type.** The annotation's name will be used as type (e.g. if you have an annotation named "Promoter", it will get "Promoter" as its type by using this option).

10.3.4 Removing annotations

Annotations can be hidden using the **Annotation Types** preferences in the **Side Panel** to the right of the view (see section 10.3.1). In order to completely remove the annotation:

right-click the annotation | Delete Annotation (👉)

If you want to remove all annotations of one type:

right-click an annotation of the type you want to remove | Delete | Delete Annotations of Type "type"

If you want to remove all annotations from a sequence:

right-click an annotation | Delete | Delete All Annotations

The removal of annotations can be undone using Ctrl + Z or Undo (↶) in the Toolbar.

If you have more sequences (e.g. in a sequence list, alignment or contig), you have two additional options:

right-click an annotation | Delete | Delete All Annotations from All Sequences

right-click an annotation | Delete | Delete Annotations of Type "type" from All Sequences

10.4 Element information

The normal view of a sequence (by double-clicking) shows the annotations as boxes along the sequence, but often there is more information available about sequences. This information is available through the **Element info** view.

To view the sequence information:

Select a sequence in the Navigation Area and right-click on the file name | Hold the mouse over "Show" to enable a list of options | Element Info (📄)

Another way to show the text view is to open the sequence in the **View Area** and click on the "Show Element Info" icon (📄) found at the bottom of the window.

This will display a view similar to fig 10.14.



Figure 10.14: The initial display of sequence info for the HUMHBB DNA sequence from the Example data.

All the lines in the view are headings, and the corresponding text can be shown by clicking the text. The information available depends on the origin of the sequence.

- **Name.** The name of the sequence which is also shown in sequence views and in the **Navigation Area**.
- **Description.** A description of the sequence.
- **Metadata.** The Metadata table and the detailed metadata values associated with the sequence.
- **Comments.** The author's comments about the sequence.
- **Keywords.** Keywords describing the sequence.
- **Db source.** Accession numbers in other databases concerning the same sequence.
- **Gb Division.** Abbreviation of GenBank divisions. See section 3.3 in the GenBank release notes for a full list of GenBank divisions.

- **Length.** The length of the sequence.
- **Modification date.** Modification date from the database. This means that this date does not reflect your own changes to the sequence. See the history (section 2.1.2) for information about the latest changes to the sequence after it was downloaded from the database.
- **Latin name.** Latin name of the organism.
- **Common name.** Scientific name of the organism.
- **Taxonomy name.** Taxonomic classification levels.
- **Read group** Read group identifier "ID", technology used to produced the reads "Platform", and sample name "Sample".
- **Paired Status.** Unpaired or Paired sequences, with in this case the Minimum and Maximum distances as well as the Read orientation set during import.

Some of the information can be edited by clicking the blue **Edit** text. This means that you can add your own information to sequences that do not derive from databases.

10.5 View as text

A sequence can be viewed as text without any layout and text formatting. This displays all the information about the sequence in the GenBank file format. To view a sequence as text:

Select a sequence in the Navigation Area and right-click on the file name | Hold the mouse over "Show" to enable a list of options | Select "Text View" (☰)

Another way to show the text view is to open the sequence in the **View Area** and click on the "Show Text View" icon (☰) found at the bottom of the window.

This makes it possible to see background information about e.g. the authors and the origin of DNA and protein sequences. Selections or the entire text of the **Sequence Text View** can be copied and pasted into other programs:

Much of the information is also displayed in the **Sequence info**, where it is easier to get an overview (see section 10.4.)

In the **Side Panel**, you find a search field for searching the text in the view.

10.6 Sequence Lists

The **Sequence List** is a file containing a number of sequences. Having sequences in a sequence list can help organizing sequence data. A Sequence List can be displayed in a graphical sequence view or in a tabular format. The two different views of the same sequence list are shown in split screen in figure 10.15.

The **graphical view of sequence lists** is almost identical to the view of single sequences (see section 10.1). The main difference is that you now can see more than one sequence in the same view, and additionally have a few extra options for sorting, deleting and adding sequences:

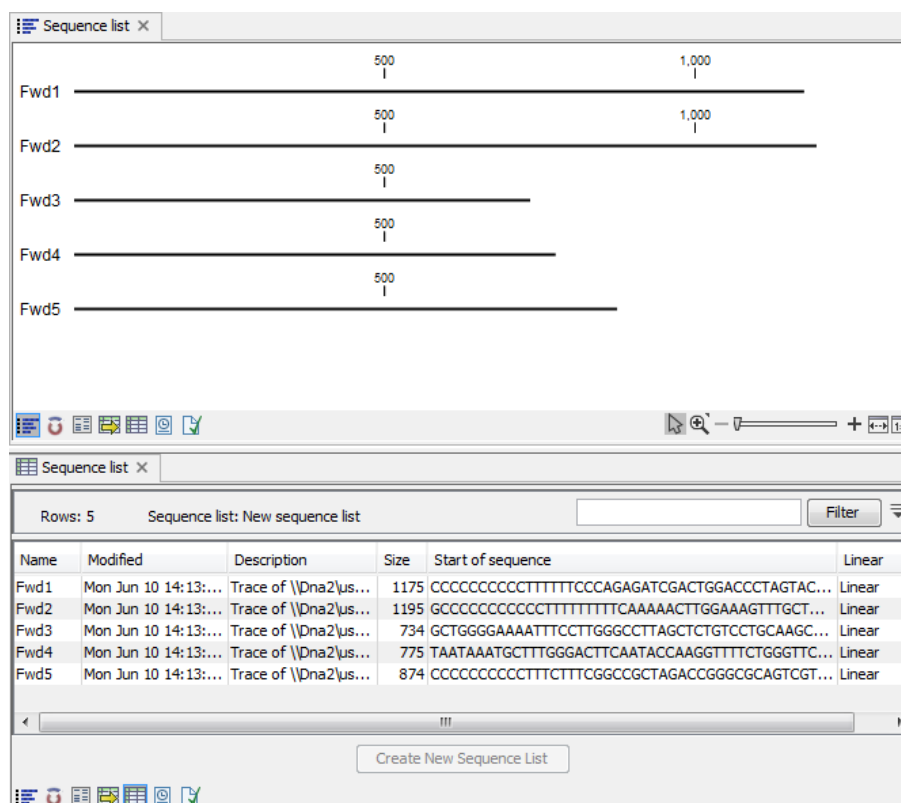

Figure 10.15: A sequence list containing multiple sequences can be viewed in either a table or in a graphical sequence list. The graphical view is useful for viewing annotations and the sequence itself, while the table view provides other information like sequence lengths, and the number of sequences in the list (number of Rows reported).

- To add extra sequences to the list, right-click an empty (white) space in the view, and select **Add Sequences**.
- To delete a sequence from the list, right-click the sequence's name and select **Delete Sequence**.
- To sort the sequences in the list, right-click the name of one of the sequences and select **Sort Sequence List by Name** or **Sort Sequence List by Length**.
- To rename a sequence, right-click the name of the sequence and select **Rename Sequence**.

Each sequence in the **table sequence list** is displayed with:

- Name
- Accession
- Description
- Modification date
- Length
- First 50 residues

The number of sequences in the list is reported as the number of Rows at the top of the table view. Adding and removing sequences from the list is easy: adding is done by dragging the sequence from another list or from the Navigation Area and drop it in the table. To delete sequences, simply select them and press **Delete** (⌘). To extract a sequence from a sequence list, drag the sequence directly from the table into the Navigation Area. Another option is to extract all sequences found in the list using the **Extract Sequences** tool. A description of how to use the **Extract Sequences** tool can be found in section 13.2.

Sequence lists are generated automatically when you import files containing more than one sequence. They may also be created as the output from particular Workbench tool, including database searches. For more information about creating sequence lists from a database search, see (chapter 7.2).

You can create a subset of a Sequence List: select the relevant sequences, right-click on the selected elements and choose **Create New Sequence List** from the drop down menu. This will generate a new sequence list that only includes the selected sequences.

A **Sequence List** can also be created from single sequences or by merging already existing sequence lists with the Workbench. To do this, select two or more sequences or sequence lists in the Navigation Area, right click on the selected elements and choose

New | Sequence List (⌘)

Alternatively, you can launch this tool via the "File" menu system.

This opens the **Sequence List** Wizard (figure 10.16). The dialog allows you to select more sequences to include in the list, or to remove already chosen sequences from the list.

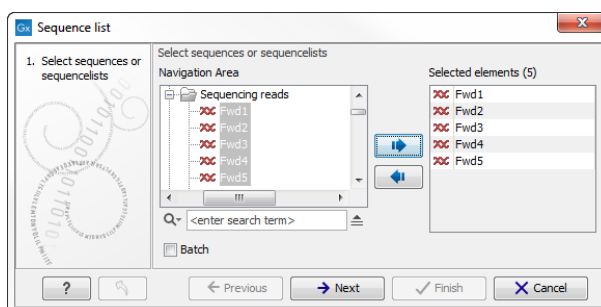

Figure 10.16: A Sequence List dialog.

If you are trying to create a new sequence list from a mixture of paired and unpaired datasets, a warning message will let you know that the resulting sequence list will be set as unpaired (figure 10.17).

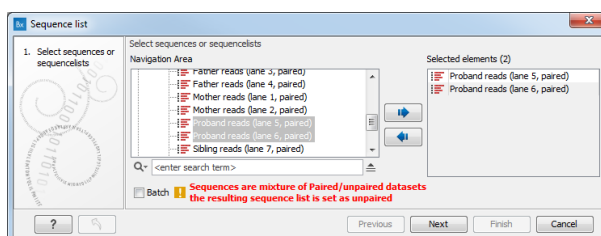

Figure 10.17: A warning appears when trying to create a new sequence list from a mixture of paired and unpaired datasets.

This warning also appears when trying to create a Sequence List out of paired reads lists for

which the the Minimum and Maximum distances are different between lists. If that is the case, distances can be edited to be similar for all lists that needs to be merged in a new one.

For this, open all Sequence Lists one after the other and click on the Show Element Info icon at the bottom of the view (figure 10.18). Edit the distances by clicking on the button "Edit" next to the entry "Paired status" and click OK. Save the Sequence lists with the edited Paired statuses before attempting to create a merged sequence List. This final list's status will be set as Paired reads.

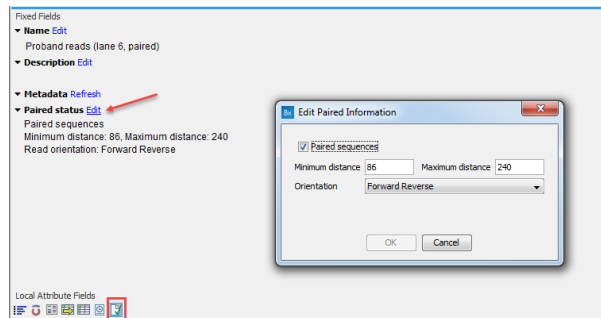

Figure 10.18: Edit the Minimum and Maximum distances of several sequence lists to be able to merge them into one.

Chapter 11

BLAST search

Contents

11.1 Running BLAST searches	256
11.1.1 BLAST at NCBI	256
11.1.2 BLAST a partial sequence against NCBI	259
11.1.3 BLAST against local data	260
11.1.4 BLAST a partial sequence against a local database	264
11.2 Output from BLAST searches	264
11.2.1 Graphical overview for each query sequence	264
11.2.2 Overview BLAST table	264
11.2.3 BLAST graphics	266
11.2.4 BLAST HSP table	267
11.2.5 BLAST hit table	269
11.2.6 Extracting a consensus sequence from a BLAST result	270
11.3 Local BLAST databases	270
11.3.1 Make pre-formatted BLAST databases available	270
11.3.2 Download NCBI pre-formatted BLAST databases	271
11.3.3 Create local BLAST databases	272
11.4 Manage BLAST databases	272
11.5 Bioinformatics explained: BLAST	274
11.5.1 Examples of BLAST usage	274
11.5.2 Searching for homology	275
11.5.3 How does BLAST work?	275
11.5.4 Which BLAST program should I use?	276
11.5.5 Which BLAST options should I change?	277
11.5.6 Explanation of the BLAST output	279
11.5.7 I want to BLAST against my own sequence database, is this possible?	279
11.5.8 What you cannot get out of BLAST	281
11.5.9 Other useful resources	282

CLC Genomics Workbench offers to conduct BLAST searches on protein and DNA sequences. In short, a BLAST search identifies homologous sequences between your input (query) query sequence and a database of sequences [McGinnis and Madden, 2004]. BLAST (Basic Local Alignment Search Tool), identifies homologous sequences using a heuristic method which finds short matches between two sequences. After initial match BLAST attempts to start local alignments from these initial matches.

If you are interested in the bioinformatics behind BLAST, there is an easy-to-read explanation of this in section 11.5.

Figure 11.9 shows an example of a BLAST result in the *CLC Genomics Workbench*.

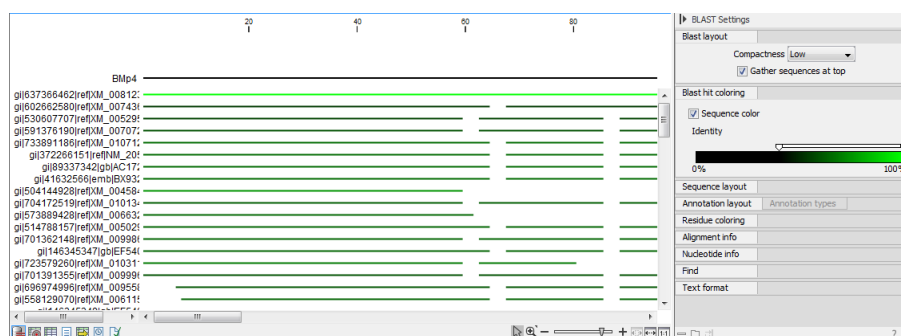

Figure 11.1: Display of the output of a BLAST search. At the top is there a graphical representation of BLAST hits with tool-tips showing additional information on individual hits. Below is a tabular form of the BLAST results.

11.1 Running BLAST searches

With the *CLC Genomics Workbench* there are two ways of performing BLAST searches: You can either have the BLAST process run on NCBI's BLAST servers (<http://www.ncbi.nlm.nih.gov/>) or you can perform the BLAST search on your own computer.

The advantage of running the BLAST search on NCBI servers is that you have readily access to the popular, and often very large, BLAST databases without having to download them to your own computer. The advantages of running BLAST on your own computer include that you can use your own sequence collections as blast databases, and that running big batch BLAST jobs can be faster and more reliable when done locally.

11.1.1 BLAST at NCBI

When running a BLAST search at the NCBI, the Workbench sends the sequences you select to the NCBI's BLAST servers. When the results are ready, they will be automatically downloaded and displayed in the Workbench. When you enter a large number of sequences for searching with BLAST, the Workbench automatically splits the sequences up into smaller subsets and sends one subset at the time to NCBI. This is to avoid exceeding any internal limits the NCBI places on the number of sequences that can be submitted to them for BLAST searching. The size of the subset created in the CLC software depends both on the number and size of the sequences.

To start a BLAST job to search your sequences against databases held at the NCBI, go to:

Toolbox | BLAST (📁) | BLAST at NCBI (🌐)

Alternatively, use the keyboard shortcut: Ctrl+Shift+B for Windows and ⌘ +Shift+B on Mac OS.

This opens the dialog seen in figure 11.2

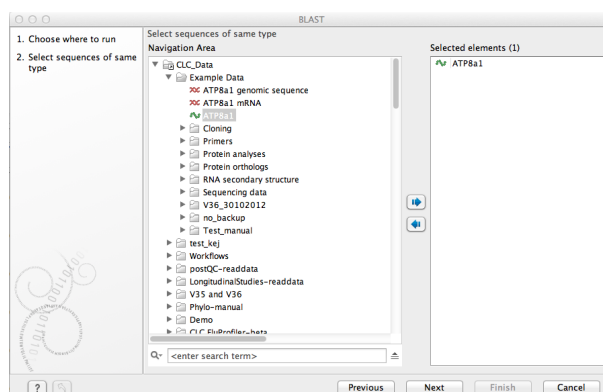

Figure 11.2: Choose one or more sequences to conduct a BLAST search with.

Select one or more sequences of the same type (either DNA or protein) and click **Next**.

In this dialog, you choose which type of BLAST search to conduct, and which database to search against (figure 11.3). The databases at the NCBI listed in the dropdown box will correspond to the query sequence type you have, DNA or protein, and the type of blast search you can choose among to run. A complete list of these databases can be found in Appendix C. Here you can also read how to add additional databases available the NCBI to the list provided in the dropdown menu.

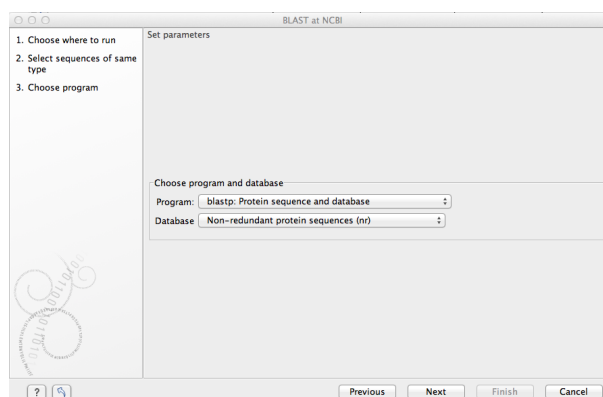

Figure 11.3: Choose a BLAST Program and a database for the search.

BLAST programs for DNA query sequences:

- **blastn: DNA sequence against a DNA database.** Searches for DNA sequences with homologous regions to your nucleotide query sequence.
- **blastx: Translated DNA sequence against a Protein database.** Automatic translation of your DNA query sequence in six frames; these translated sequences are then used to search a protein database.
- **tblastx: Translated DNA sequence against a Translated DNA database.** Automatic translation of your DNA query sequence and the DNA database, in six frames. The resulting

peptide query sequences are used to search the resulting peptide database. Note that this type of search is computationally intensive.

BLAST programs for protein query sequences:

- **blastp: Protein sequence against Protein database.** Used to look for peptide sequences with homologous regions to your peptide query sequence.
- **tblastn: Protein sequence against Translated DNA database.** Peptide query sequences are searched against an automatically translated, in six frames, DNA database.

If you search against the **Protein Data Bank protein** database homologous sequences are found to the query sequence, these can be downloaded and opened with the 3D view.

Click **Next**.

This window, see figure 11.4, allows you to choose parameters to tune your BLAST search, to meet your requirements.

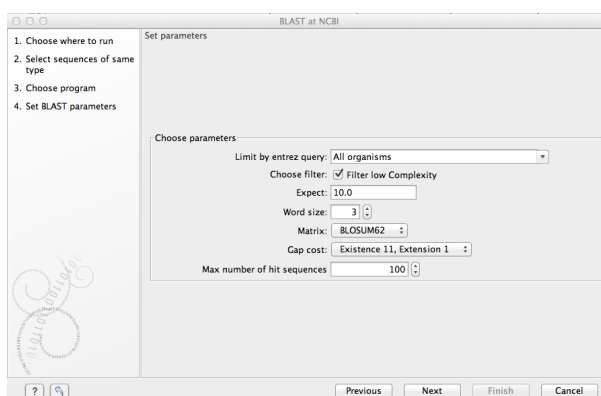

Figure 11.4: Parameters that can be set before submitting a BLAST search.

When choosing blastx or tblastx to conduct a search, you get the option of selecting a translation table for the genetic code. The standard genetic code is set as default. This setting is particularly useful when working with organisms or organelles that have a genetic code different from the standard genetic code.

The following description of BLAST search parameters is based on information from <http://www.ncbi.nlm.nih.gov/BLAST/blastcgihelp.shtml>.

- **Limit by Entrez query.** BLAST searches can be limited to the results of an Entrez query against the database chosen. This can be used to limit searches to subsets of entries in the BLAST databases. Any terms can be entered that would normally be allowed in an Entrez search session. More information about Entrez queries can be found at http://www.ncbi.nlm.nih.gov/books/NBK3837/#EntrezHelp.Entrez_Searching_Options. The syntax described there is the same as would be accepted in the CLC interface. Some commonly used Entrez queries are pre-entered and can be chosen in the drop down menu.
- **Choose filter.** You can choose to apply **Low-complexity**. Mask off segments of the query sequence that have low compositional complexity. Filtering can eliminate statistically

significant, but biologically uninteresting reports from the BLAST output (e.g. hits against common acidic-, basic- or proline-rich regions), leaving the more biologically interesting regions of the query sequence available for specific matching against database sequences.

- **Expect.** The threshold for reporting matches against database sequences: the default value is 10, meaning that under the circumstances of this search, 10 matches are expected to be found merely by chance according to the stochastic model of Karlin and Altschul (1990). Details of how E-values are calculated can be found at the NCBI: <http://www.ncbi.nlm.nih.gov/BLAST/tutorial/Altschul-1.html> If the E-value ascribed to a match is greater than the EXPECT threshold, the match will not be reported. Lower EXPECT thresholds are more stringent, leading to fewer chance matches being reported. Increasing the threshold results in more matches being reported, but many may just matching by chance, not due to any biological similarity. Values of E less than one can be entered as decimals, or in scientific notation. For example, 0.001, 1e-3 and 10e-4 would be equivalent and acceptable values.
- **Word Size.** BLAST is a heuristic that works by finding word-matches between the query and database sequences. You may think of this process as finding "hot-spots" that BLAST can then use to initiate extensions that might lead to full-blown alignments. For nucleotide-nucleotide searches (i.e. "BLASTn") an exact match of the entire word is required before an extension is initiated, so that you normally regulate the sensitivity and speed of the search by increasing or decreasing the wordsize. For other BLAST searches non-exact word matches are taken into account based upon the similarity between words. The amount of similarity can be varied so that you normally uses just the wordsizes 2 and 3 for these searches.
- **Match/mismatch** A key element in evaluating the quality of a pairwise sequence alignment is the "substitution matrix", which assigns a score for aligning any possible pair of residues. The matrix used in a BLAST search can be changed depending on the type of sequences you are searching with (see the BLAST Frequently Asked Questions). Only applicable for protein sequences or translated DNA sequences.
- **Gap Cost.** The pull down menu shows the Gap Costs (Penalty to open Gap and penalty to extend Gap). Increasing the Gap Costs and Lambda ratio will result in alignments which decrease the number of Gaps introduced.
- **Max number of hit sequences.** The maximum number of database sequences, where BLAST found matches to your query sequence, to be included in the BLAST report.

The parameters you choose will affect how long BLAST takes to run. A search of a small database, requesting only hits that meet stringent criteria will generally be quite quick. Searching large databases, or allowing for very remote matches, will of course take longer.

Click **Next** if you wish to adjust how to handle the results (see section 8.2). If not, click **Finish**.

11.1.2 BLAST a partial sequence against NCBI

You can search a database using only a part of a sequence directly from the sequence view:

select the sequence region to send to BLAST | right-click the selection | BLAST Selection Against NCBI 

This will go directly to the dialog shown in figure 11.3 and the rest of the options are the same as when performing a BLAST search with a full sequence.

11.1.3 BLAST against local data

Running BLAST searches on your local machine can have several advantages over running the searches remotely at the NCBI:

- It can be faster.
- It does not rely on having a stable internet connection.
- It does not depend on the availability of the NCBI BLAST servers.
- You can use longer query sequences.
- You use your own data sets to search against.

On a technical level, the *CLC Genomics Workbench* uses the NCBI's blast+ software (see <ftp://ftp.ncbi.nlm.nih.gov/blast/executables/blast+/LATEST/>). Thus, the results of using a particular data set to search the same database, with the same search parameters, would give the same results, whether run locally or at the NCBI.

There are a number of options for what you can search against:

- You can create a database based on data already imported into your Workbench (see section 11.3.3)
- You can add pre-formatted databases (see section 11.3.1)
- You can use sequence data from the **Navigation Area** directly, without creating a database first.

To conduct a local BLAST search, go to:

Toolbox | BLAST  | **BLAST** 

This opens the dialog seen in figure 11.5:

Select one or more sequences of the same type (DNA or protein) and click **Next**.

This opens the dialog seen in figure 11.6:

At the top, you can choose between different BLAST programs.

BLAST programs for DNA query sequences:

- **blastn: DNA sequence against a DNA database.** Searches for DNA sequences with homologous regions to your nucleotide query sequence.
- **blastx: Translated DNA sequence against a Protein database.** Automatic translation of your DNA query sequence in six frames; these translated sequences are then used to search a protein database.

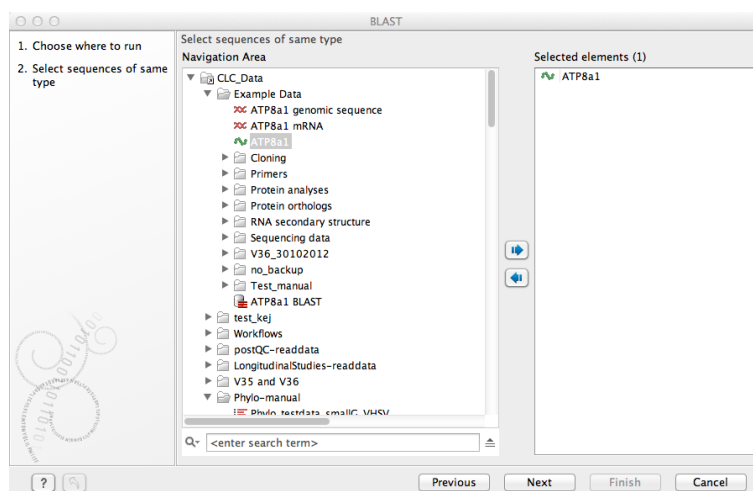

Figure 11.5: Choose one or more sequences to conduct a BLAST search.

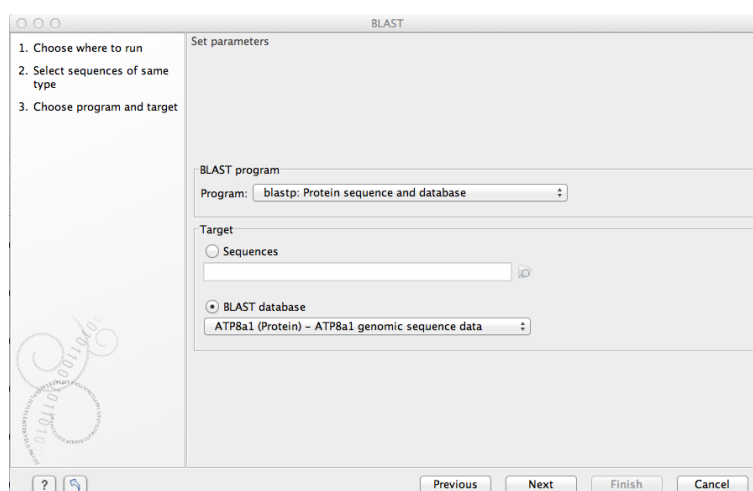

Figure 11.6: Choose a BLAST program and a target database.

- **tblastx: Translated DNA sequence against a Translated DNA database.** Automatic translation of your DNA query sequence and the DNA database, in six frames. The resulting peptide query sequences are used to search the resulting peptide database. Note that this type of search is computationally intensive.

BLAST programs for protein query sequences:

- **blastp: Protein sequence against Protein database.** Used to look for peptide sequences with homologous regions to your peptide query sequence.
- **tblastn: Protein sequence against Translated DNA database.** Peptide query sequences are searched against an automatically translated, in six frames, DNA database.

In cases where you have selected blastx or tblastx to conduct a search, you will get the option of selecting a translation table for the genetic code. The standard genetic code is set as default. This setting is particularly useful when working with organisms or organelles that have a genetic code that differs from the standard genetic code.

If you search against the **Protein Data Bank** database and homologous sequences are found to the query sequence, these can be downloaded and opened with the **3D Molecule Viewer** (see section 12.1.3).

Click **Next**.

This dialog allows you to adjust the parameters to meet the requirements of your BLAST search (figure 11.7).

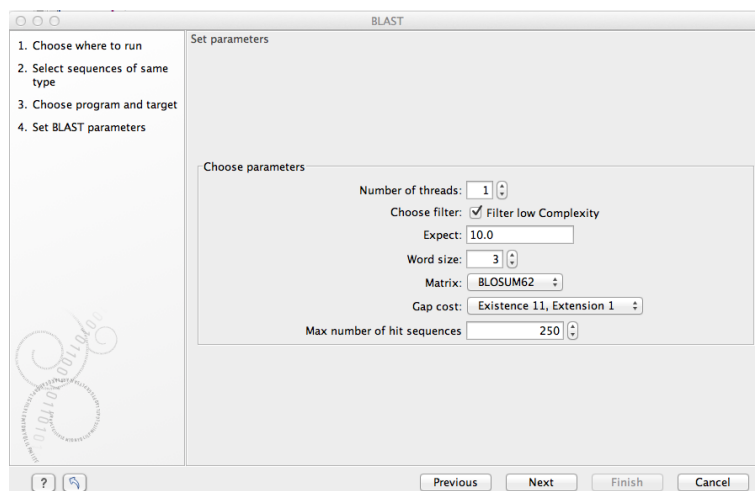



Figure 11.7: Parameters that can be set before submitting a local BLAST search.

- **Number of threads.** You can specify the number of threads, which should be used if your Workbench is installed on a multi-threaded system.
- **Choose filter.** You can choose to apply **Low-complexity**. Mask off segments of the query sequence that have low compositional complexity. Filtering can eliminate statistically significant, but biologically uninteresting reports from the BLAST output (e.g. hits against common acidic-, basic- or proline-rich regions), leaving the more biologically interesting regions of the query sequence available for specific matching against database sequences.
- **Expect.** The threshold for reporting matches against database sequences: the default value is 10, meaning that under the circumstances of this search, 10 matches are expected to be found merely by chance according to the stochastic model of Karlin and Altschul (1990). Details of how E-values are calculated can be found at the NCBI: <http://www.ncbi.nlm.nih.gov/BLAST/tutorial/Altschul-1.html> If the E-value ascribed to a match is greater than the EXPECT threshold, the match will not be reported. Lower EXPECT thresholds are more stringent, leading to fewer chance matches being reported. Increasing the threshold results in more matches being reported, but many may just matching by chance, not due to any biological similarity. Values of E less than one can be entered as decimals, or in scientific notation. For example, 0.001, 1e-3 and 10e-4 would be equivalent and acceptable values.
- **Word Size.** BLAST is a heuristic that works by finding word-matches between the query and database sequences. You may think of this process as finding "hot-spots" that BLAST can then use to initiate extensions that might lead to full-blown alignments. For nucleotide-nucleotide searches (i.e. "BLASTn") an exact match of the entire word is required before an extension is initiated, so that you normally regulate the sensitivity and speed of the

search by increasing or decreasing the wordsize. For other BLAST searches non-exact word matches are taken into account based upon the similarity between words. The amount of similarity can be varied so that you normally uses just the wordsizes 2 and 3 for these searches.

- **Match/mismatch** A key element in evaluating the quality of a pairwise sequence alignment is the "substitution matrix", which assigns a score for aligning any possible pair of residues. The matrix used in a BLAST search can be changed depending on the type of sequences you are searching with (see the BLAST Frequently Asked Questions). Only applicable for protein sequences or translated DNA sequences.
- **Gap Cost.** The pull down menu shows the Gap Costs (Penalty to open Gap and penalty to extend Gap). Increasing the Gap Costs and Lambda ratio will result in alignments which decrease the number of Gaps introduced.
- **Max number of hit sequences.** The maximum number of database sequences, where BLAST found matches to your query sequence, to be included in the BLAST report.

You then specify the target database to use:

- **Sequences.** When you choose this option, you can use sequence data from the **Navigation Area** as database by clicking the **Browse and select** icon (). A temporary BLAST database will be created from these sequences and used for the BLAST search. It is deleted afterwards. If you want to be able to click in the BLAST result to retrieve the hit sequences from the BLAST database at a later point, you should *not* use this option; create a BLAST database first, see section 11.3.3.
- **BLAST Database.** Select a database already available in one of your designated BLAST database folders. Read more in section 11.4.

When a database or a set of sequences has been selected, click **Next**.

This opens the dialog seen in figure 11.8:

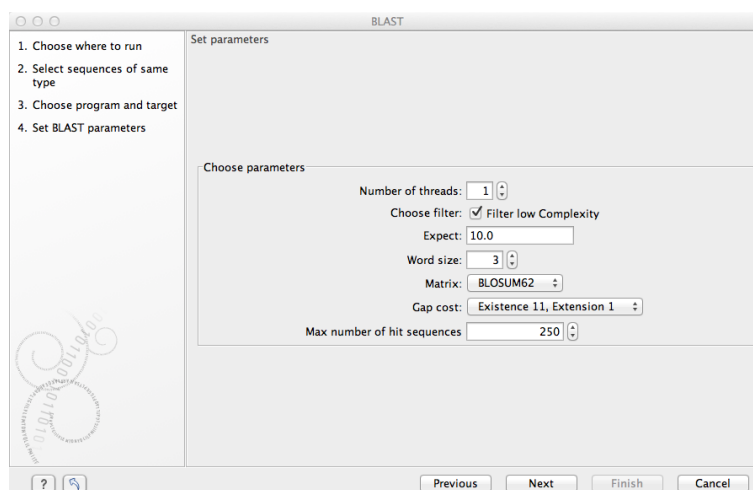

Figure 11.8: Examples of parameters that can be set before submitting a BLAST search.

See section 11.1.1 for information about these limitations.

11.1.4 BLAST a partial sequence against a local database

You can search a database using only a part of a sequence directly from the sequence view:

select the region that you wish to BLAST | right-click the selection | BLAST Selection Against Local Database (🔍)

This will go directly to the dialog shown in figure 11.6 and the rest of the options are the same as when performing a BLAST search with a full sequence.

11.2 Output from BLAST searches

The output of a BLAST search is similar whether you have chosen to run your search locally or at the NCBI.

If a **single query** sequence was used, then the results will show the hits and High-Scoring Segment Pairs (HSPs) found in that database with that single sequence. If **more than one query** sequence was used, the default view of the results is a summary table, where the description of the top match found for each query sequence and the number of matches found is reported. The summary table is described in detail in section 11.2.2.

11.2.1 Graphical overview for each query sequence

Double clicking on a given row of a tabular blast table opens a graphical overview of the blast results for a particular query sequence, as shown in figure figure 11.9. In cases where only one sequence was entered into a BLAST search, such a graphical overview is the default output.

Figure 11.9 shows an example of a BLAST result for an individual query sequence in the *CLC Genomics Workbench*.

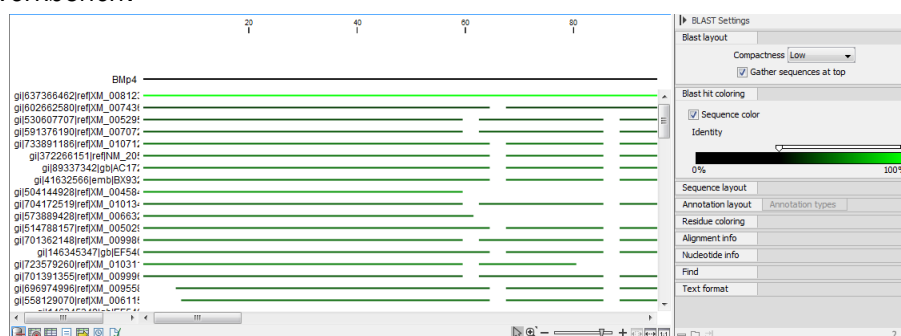

Figure 11.9: Default display of the output of a BLAST search for one query sequence. At the top is there a graphical representation of BLAST hits with tooltips showing additional information on individual hits.

Detailed descriptions of the overview BLAST table and the graphical BLAST results view are described below.

11.2.2 Overview BLAST table

In the overview BLAST table for a multi-sequence blast search, as shown in figure 11.10, there is one row for each query sequence. Each row represents the BLAST result for this query sequence.

The screenshot shows a web-based interface for BLAST results. At the top, it says 'Rows: 2' and has a 'Filter' button. Below is a table with the following data:

Query	Number of hits	Lowest E-value	Accession (E-value)
ATP8a1 genomic sequence		624	0.00 ATP8a1_genomic_sequence
ATP8a1 mRNA		50	0.00 ATP8a1_genomic_sequence

At the bottom of the table, there are three buttons: 'Open BLAST Output', 'Extract Consensus', and 'Open Query Sequence'.

Figure 11.10: An overview BLAST table summarizing the results for a number of query sequences.

Double-clicking a row will open the BLAST result for this query sequence, allowing more detailed investigation of the result. You can also select one or more rows and click the **Open BLAST Output** button at the bottom of the view. Consensus sequence can be extracted by clicking the **Extract Consensus** button at the bottom. Clicking the **Open Query Sequence** will open a sequence list with the selected query sequences. This can be useful in work flows where BLAST is used as a filtering mechanism where you can filter the table to include e.g. sequences that have a certain top hit and then extract those.

In the overview table, the following information is shown:

- Query: Since this table displays information about several query sequences, the first column is the name of the query sequence.
- Number of HSPs: The number of High-scoring Segment Pairs (HSPs) for this query sequence.
- For the following list, the value of the best HSP is displayed together with accession number and description of this HSP, with respect to E-value, identity or positive value, hit length or bit score.
 - Lowest E-value
 - Accession (E-value)
 - Description (E-value)
 - Greatest identity %
 - Accession (identity %)
 - Description (identity %)
 - Greatest positive %
 - Accession (positive %)
 - Description (positive %)
 - Greatest HSPs length
 - Accession (HSP length)
 - Description (HSP length)
 - Greatest bit score
 - Accession (bit score)
 - Description (bit score)

If you wish to save some of the BLAST results as individual elements in the **Navigation Area**, open them and click **Save As** in the **File** menu.

11.2.3 BLAST graphics

The **BLAST editor** shows the sequences hits which were found in the BLAST search. The hit sequences are represented by colored horizontal lines, and when hovering the mouse pointer over a BLAST hit sequence, a tooltip appears, listing the characteristics of the sequence. As default, the query sequence is fitted to the window width, but it is possible to zoom in the windows and see the actual sequence alignments returned from the BLAST server.

There are several settings available in the **BLAST Settings** side panel.

- **Blast layout.** You can control the level of **Compactness** for displaying sequences:
 - **Not compact.** Full detail and spaces between the sequences.
 - **Low.** The normal settings where the residues are visible (when zoomed in) but with no extra spaces between.
 - **Medium.** The sequences are represented as lines and the residues are not visible. There is some space between the sequences.
 - **Compact.** Even less space between the sequences.

You can also choose to **Gather sequences at top**. Enabling this option affects the view that is shown when scrolling horizontally along a BLAST result. If selected, the sequence hits which did not contribute to the visible part of the BLAST graphics will be omitted whereas the found BLAST hits will automatically be placed right below the query sequence.

- **BLAST hit coloring.** You can choose whether to color hit sequences and adjust the coloring scale for visualisation of identity level.

The remaining View preferences for BLAST Graphics are the same as those of alignments. See section [10.1](#).

Some of the information available in the tooltips when hovering over a particular hit sequence is:

- **Name of sequence.** Here is shown some additional information of the sequence which was found. This line corresponds to the description line in GenBank (if the search was conducted on the nr database).
- **Score.** This shows the bit score of the local alignment generated through the BLAST search.
- **Expect.** Also known as the E-value. A low value indicates a homologous sequence. Higher E-values indicate that BLAST found a less homologous sequence.
- **Identities.** This number shows the number of identical residues or nucleotides in the obtained alignment.
- **Gaps.** This number shows whether the alignment has gaps or not.
- **Strand.** This is only valid for nucleotide sequences and show the direction of the aligned strands. Minus indicate a complementary strand.

The numbers of the query and subject sequences refer to the sequence positions in the submitted and found sequences. If the subject sequence has number 59 in front of the sequence, this

means that 58 residues are found upstream of this position, but these are not included in the alignment.

By right clicking the sequence name in the Graphical BLAST output it is possible to download the full hits sequence from NCBI with accompanying annotations and information. It is also possible to just open the actual hit sequence in a new view.

11.2.4 BLAST HSP table

In addition to the graphical display of a BLAST result, it is possible to view the BLAST results in a tabular view. In the tabular view, one can get a quick and fast overview of the results. Here you can also select multiple sequences and download or open all of these in one single step. Moreover, there is a link from each sequence to the sequence at NCBI. These possibilities are either available through a right-click with the mouse or by using the buttons below the table.

The **BLAST table** view can be shown in the following way:

Click the **Show BLAST HSP Table** button () at the bottom of the view

Figure 11.11 is an example of a BLAST HSP Table.

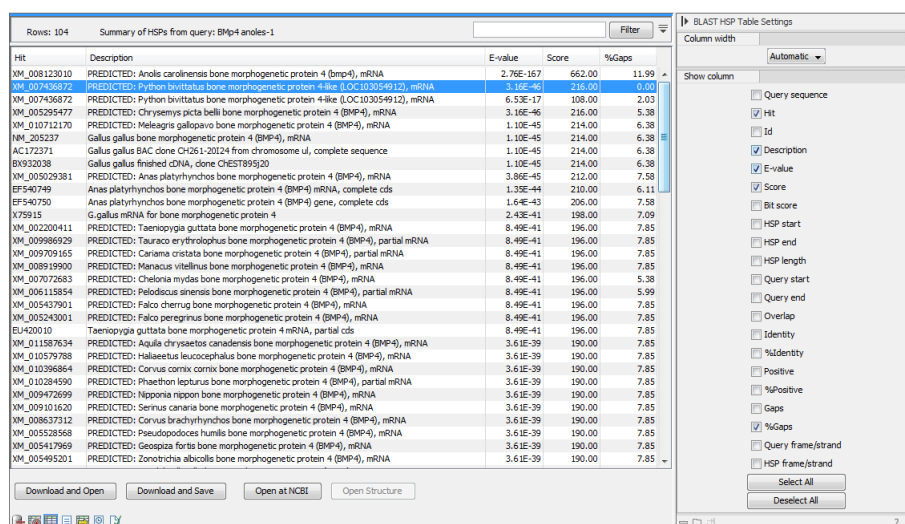

Hit	Description	E-value	Score	%Gaps
XM_008123010	PREDICTED: Anolis carolinensis bone morphogenetic protein 4 (Bmp4), mRNA	2.76E-167	662.00	11.99
XM_007436872	PREDICTED: Python bivittatus bone morphogenetic protein 4 like (LOC103054912), mRNA	3.16E-46	216.00	0.00
XM_007436872	PREDICTED: Python bivittatus bone morphogenetic protein 4 like (LOC103054912), mRNA	6.53E-17	108.00	2.03
XM_005295777	PREDICTED: Chrysemys picta bellii bone morphogenetic protein 4 (BMP4), mRNA	3.10E-46	216.00	5.38
XM_010712170	PREDICTED: Meleagris gallopavo bone morphogenetic protein 4 (BMP4), mRNA	1.10E-45	214.00	6.38
NM_205237	Gallus gallus bone morphogenetic protein 4 (BMP4), mRNA	1.10E-45	214.00	6.38
AC172371	Gallus gallus BAC clone Ch1261-20124 from chromosome U, complete sequence	1.10E-45	214.00	6.38
BM932038	Gallus gallus finished cDNA, clone CHEST89520	1.10E-45	214.00	6.38
XM_005029381	PREDICTED: Anas platyrhynchos bone morphogenetic protein 4 (BMP4), mRNA	3.60E-45	212.00	7.58
EF540789	Anas platyrhynchos bone morphogenetic protein 4 (BMP4) mRNA, complete cds	1.33E-44	210.00	6.11
EF540790	Anas platyrhynchos bone morphogenetic protein 4 (BMP4) gene, complete cds	1.64E-43	206.00	7.58
X75915	G.gallus mRNA for bone morphogenetic protein 4	2.43E-41	198.00	7.09
XM_002200411	PREDICTED: Taeniopygia guttata bone morphogenetic protein 4 (BMP4), mRNA	8.49E-41	196.00	7.85
XM_00986929	PREDICTED: Taurus erythraeops bone morphogenetic protein 4 (BMP4), partial mRNA	8.49E-41	196.00	7.85
XM_009709165	PREDICTED: Cariana cristata bone morphogenetic protein 4 (BMP4), partial mRNA	8.49E-41	196.00	7.85
XM_008919900	PREDICTED: Manacus vitellinus bone morphogenetic protein 4 (BMP4), mRNA	8.49E-41	196.00	7.85
XM_007072683	PREDICTED: Chelonia mydas bone morphogenetic protein 4 (BMP4), mRNA	8.49E-41	196.00	5.38
XM_006115854	PREDICTED: Pelodiscus amurens bone morphogenetic protein 4 (BMP4), partial mRNA	8.49E-41	196.00	5.99
XM_005437901	PREDICTED: Falco cherrug bone morphogenetic protein 4 (BMP4), mRNA	8.49E-41	196.00	7.85
XM_005243001	PREDICTED: Falco peregrinus bone morphogenetic protein 4 (BMP4), mRNA	8.49E-41	196.00	7.85
EU420010	Taeniopygia guttata bone morphogenetic protein 4 mRNA, partial cds	8.49E-41	196.00	7.85
XM_011587634	PREDICTED: Aquila chrysaetos canadensis bone morphogenetic protein 4 (BMP4), mRNA	3.61E-39	190.00	7.85
XM_010579788	PREDICTED: Haliaeetus leucoccephalus bone morphogenetic protein 4 (BMP4), mRNA	3.61E-39	190.00	7.85
XM_010368464	PREDICTED: Corvus corax cornix bone morphogenetic protein 4 (BMP4), mRNA	3.61E-39	190.00	7.85
XM_010284590	PREDICTED: Phaeothorax lepturus bone morphogenetic protein 4 (BMP4), partial mRNA	3.61E-39	190.00	7.85
XM_009472699	PREDICTED: Nipponia nippon bone morphogenetic protein 4 (BMP4), mRNA	3.61E-39	190.00	7.85
XM_009101620	PREDICTED: Serinus canaria bone morphogenetic protein 4 (BMP4), mRNA	3.61E-39	190.00	7.85
XM_008537312	PREDICTED: Corvus brachyrhynchos bone morphogenetic protein 4 (BMP4), mRNA	3.61E-39	190.00	7.85
XM_005328568	PREDICTED: Pseudopodiceps humilis bone morphogenetic protein 4 (BMP4), mRNA	3.61E-39	190.00	7.85
XM_005417969	PREDICTED: Geopelia fortis bone morphogenetic protein 4 (BMP4), mRNA	3.61E-39	190.00	7.85
XM_005495201	PREDICTED: Zonotrichia albicollis bone morphogenetic protein 4 (BMP4), mRNA	3.61E-39	190.00	7.85

Figure 11.11: *BLAST HSP Table*. The HSPs can be sorted by the different columns, simply by clicking the column heading.

The BLAST HSP Table includes the following information:

- **Query sequence.** The sequence which was used for the search.
- **HSP.** The Name of the sequences found in the BLAST search.
- **Id.** GenBank ID.
- **Description.** Text from NCBI describing the sequence.
- **E-value.** Measure of quality of the match. Higher E-values indicate that BLAST found a less homologous sequence.
- **Score.** This shows the score of the local alignment generated through the BLAST search.

- **Bit score.** This shows the bit score of the local alignment generated through the BLAST search. Bit scores are normalized, which means that the bit scores from different alignments can be compared, even if different scoring matrices have been used.
- **HSP start.** Shows the start position in the HSP sequence.
- **HSP end.** Shows the end position in the HSP sequence.
- **HSP length.** The length of the HSP.
- **Query start.** Shows the start position in the query sequence.
- **Query end.** Shows the end position in the query sequence.
- **Overlap.** Display a percentage value for the overlap of the query sequence and HSP sequence. Only the length of the local alignment is taken into account and not the full length query sequence.
- **Identity.** Shows the number of identical residues in the query and HSP sequence.
- **%Identity.** Shows the percentage of identical residues in the query and HSP sequence.
- **Positive.** Shows the number of similar but not necessarily identical residues in the query and HSP sequence.
- **%Positive.** Shows the percentage of similar but not necessarily identical residues in the query and HSP sequence.
- **Gaps.** Shows the number of gaps in the query and HSP sequence.
- **%Gaps.** Shows the percentage of gaps in the query and HSP sequence.
- **Query Frame/Strand.** Shows the frame or strand of the query sequence.
- **HSP Frame/Strand.** Shows the frame or strand of the HSP sequence.

In the **BLAST table** view you can handle the HSP sequences. Select one or more sequences from the table, and apply one of the following functions.

- **Download and Open.** Download the full sequence from NCBI and opens it. If multiple sequences are selected, they will all open (if the same sequence is listed several times, only one copy of the sequence is downloaded and opened).
- **Download and Save.** Download the full sequence from NCBI and save it. When you click the button, there will be a save dialog letting you specify a folder to save the sequences. If multiple sequences are selected, they will all open (if the same sequence is listed several times, only one copy of the sequence is downloaded and opened).
- **Open at NCBI.** Opens the corresponding sequence(s) at GenBank at NCBI. Here is stored additional information regarding the selected sequence(s). The default Internet browser is used for this purpose.
- **Open structure.** If the HSP sequence contain structure information, the sequence is opened in a text view or a 3D view (3D view in *CLC Main Workbench* or *CLC Genomics Workbench*).

The HSPs can be sorted by the different columns, simply by clicking the column heading. In cases where individual rows have been selected in the table, the selected rows will still be selected after sorting the data.

You can do a text-based search in the information in the BLAST table by using the filter at the upper right part of the view. In this way you can search for e.g. species or other information which is typically included in the "Description" field.

The table is integrated with the graphical view described in section 11.2.3 so that selecting a HSP in the table will make a selection on the corresponding sequence in the graphical view.

11.2.5 BLAST hit table

The **BLAST Hit table** view can be shown in the following way:

Click the Show BLAST Hit Table button () at the bottom of the view

Figure 11.12 is an example of a BLAST Hit Table.

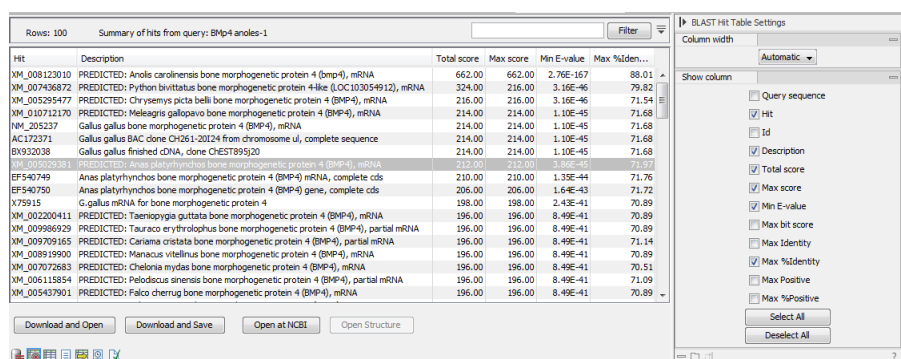

Hit	Description	Total score	Max score	Min E-value	Max %Iden...
NM_008123010	PREDICTED: Anolis carolinensis bone morphogenetic protein 4 (BMP4), mRNA	662.00	662.00	2.76E-167	88.01
NM_007936872	PREDICTED: Python bivittatus bone morphogenetic protein 4-like (LOC103954912), mRNA	324.00	216.00	3.16E-46	79.82
NM_005295477	PREDICTED: Chrysemys picta bellii bone morphogenetic protein 4 (BMP4), mRNA	216.00	216.00	3.16E-46	71.54
NM_010712170	PREDICTED: Meleagris gallopavo bone morphogenetic protein 4 (BMP4), mRNA	214.00	214.00	1.10E-45	71.68
NM_205237	Gallus gallus bone morphogenetic protein 4 (BMP4), mRNA	214.00	214.00	1.10E-45	71.68
AC_123271	Gallus gallus BAC clone CH261-20124 from chromosome u1, complete sequence	214.00	214.00	1.10E-45	71.68
U93238	Gallus gallus finished cDNA, clone CEST9520	214.00	214.00	1.10E-45	71.68
NM_002929381	PREDICTED: Scops polyborus bone morphogenetic protein 4 (BMP4), mRNA	212.00	212.00	3.83E-45	71.52
EF540749	Anas platyrhynchos bone morphogenetic protein 4 (BMP4) mRNA, complete cds	210.00	210.00	1.33E-44	71.76
EF540750	Anas platyrhynchos bone morphogenetic protein 4 (BMP4) gene, complete cds	206.00	206.00	1.64E-43	71.72
X79915	G. gallus mRNA for bone morphogenetic protein 4	198.00	198.00	2.43E-41	70.89
NM_002200411	PREDICTED: Taeniopygia guttata bone morphogenetic protein 4 (BMP4), mRNA	196.00	196.00	8.49E-41	70.89
NM_00986929	PREDICTED: Tauraco erythrolophus bone morphogenetic protein 4 (BMP4), partial mRNA	196.00	196.00	8.49E-41	70.89
NM_009709165	PREDICTED: Cariacus cristata bone morphogenetic protein 4 (BMP4), partial mRNA	196.00	196.00	8.49E-41	71.14
NM_008919900	PREDICTED: Manacus vitellinus bone morphogenetic protein 4 (BMP4), mRNA	196.00	196.00	8.49E-41	70.89
NM_00702863	PREDICTED: Chelonia mydas bone morphogenetic protein 4 (BMP4), mRNA	196.00	196.00	8.49E-41	70.51
NM_006118854	PREDICTED: Pelodiscus sinensis bone morphogenetic protein 4 (BMP4), partial mRNA	196.00	196.00	8.49E-41	71.09
NM_005437901	PREDICTED: Falco cherrug bone morphogenetic protein 4 (BMP4), mRNA	196.00	196.00	8.49E-41	70.89

Figure 11.12: BLAST Hit Table. The hits can be sorted by the different columns, simply by clicking the column heading.

The BLAST Hit Table includes the following information:

- **Query sequence.** The sequence which was used for the search.
- **Hit.** The Name of the sequences found in the BLAST search.
- **Id.** GenBank ID.
- **Description.** Text from NCBI describing the sequence.
- **Total Score.** Total score for all HSPs.
- **Max Score.** Maximum score of all HSPs.
- **Min E-value.** Minimum e-value of all HSPs.
- **Max Bit score.** Maximum Bit score of all HSPs.
- **Max Identity.** Shows the maximum number of identical residues in the query and Hit sequence.

- **Max %Identity.** Shows the percentage of maximum identical residues in the query and Hit sequence.
- **Max Positive.** Shows the maximum number of similar but not necessarily identical residues in the query and Hit sequence.
- **Max %Positive.** Shows the percentage of maximum similar but not necessarily identical residues in the query and Hit sequence.

11.2.6 Extracting a consensus sequence from a BLAST result

It is possible to batch extract a consensus sequence from a BLAST result. This is described in more detail in section 24.8.

11.3 Local BLAST databases

BLAST databases on your local system can be made available for searches via your *CLC Genomics Workbench*, (section 11.3.1). To make adding databases even easier, you can download pre-formatted BLAST databases from the NCBI from within your *CLC Genomics Workbench*, (section 11.3.2). You can also easily create your own local blast databases from sequences within your *CLC Genomics Workbench*, (section 11.3.3).

11.3.1 Make pre-formatted BLAST databases available

To use databases that have been downloaded or created outside the Workbench, you can either:

- Put the database files in one of the locations defined in the BLAST database manager (see section 11.4). All the files that comprise a given BLAST database must be included. This may be as few as three files, but can be more (figure 11.13).
- Add the location where your BLAST databases are stored using the BLAST database manager (see section 11.4) (figure 11.17).

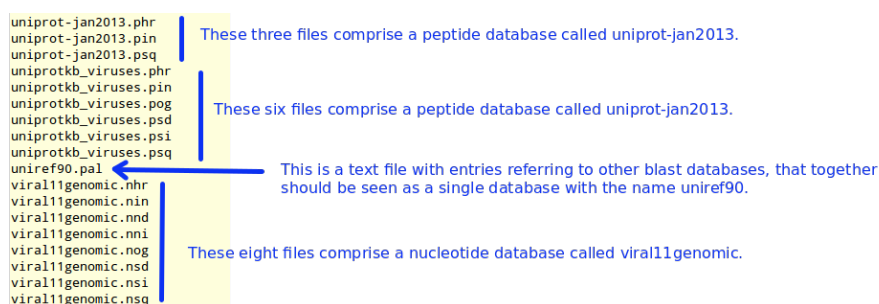

Figure 11.13: BLAST databases are made up of several files. The exact number varies and depends on the tool used to build the databases as well as how large the database is. Large databases will be split into the number of volumes and there will be several files per volume. If you have made your BLAST database, or downloaded BLAST database files, outside the Workbench, you will need to ensure that all the files associated with that BLAST database are available in a CLC Blast database location.

11.3.2 Download NCBI pre-formatted BLAST databases

Many popular pre-formatted databases are available for download from the NCBI. You can download any of the databases available from the list at <ftp://ftp.ncbi.nlm.nih.gov/blast/db/> from within your *CLC Genomics Workbench*.

You must be connected to the internet to use this tool.

To download a database, go to:

Toolbox | BLAST (📁) | Download BLAST Databases (🌐)

A window like the one in figure 11.14 pops up showing you the list of databases available for download.

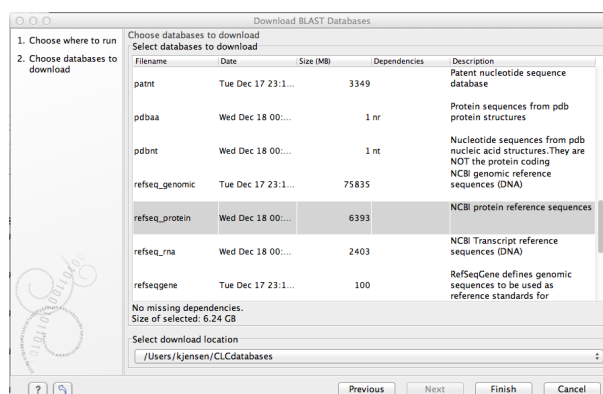

Figure 11.14: Choose from pre-formatted BLAST databases at the NCBI available for download.

In this window, you can see the names of the databases, the date they were made available for download on the NCBI site, the size of the files associated with that database, and a brief description of each database. You can also see whether the database has any dependencies. This aspect is described below.

You can also specify which of your database locations you would like to store the files in. Please see the **Manage BLAST Databases** section for more on this (section 11.4).

There are two very important things to note if you wish to take advantage of this tool.

- Many of the databases listed are very large. Please make sure you have space for them. If you are working on a shared system, we recommend you discuss your plans with your system administrator and fellow users.
- Some of the databases listed are dependent on others. This will be listed in the **Dependencies** column of the **Download BLAST Databases** window. This means that while the database you are interested in may seem very small, it may require that you also download a very big database on which it depends.

An example of the second item above is *Swissprot*. To download a database from the NCBI that would allow you to search just Swissprot entries, you need to download the whole *nr* database in addition to the entry for Swissprot.

11.3.3 Create local BLAST databases

In the *CLC Genomics Workbench* you can create a local database that you can use for local BLAST searches. You can specify a location on your computer to save the BLAST database files to. The Workbench will list the BLAST databases found in these locations when you set up a local BLAST search (see section 11.1.3).

DNA, RNA, and protein sequences located in the **Navigation Area** can be used to create BLAST databases from. Any given BLAST database can only include one molecule type. If you wish to use a pre-formatted BLAST database instead, see section 11.3.1.

To create a BLAST database, go to:

Toolbox | BLAST (📄) | Create BLAST Database (🛠️)

This opens the dialog seen in figure 11.15.

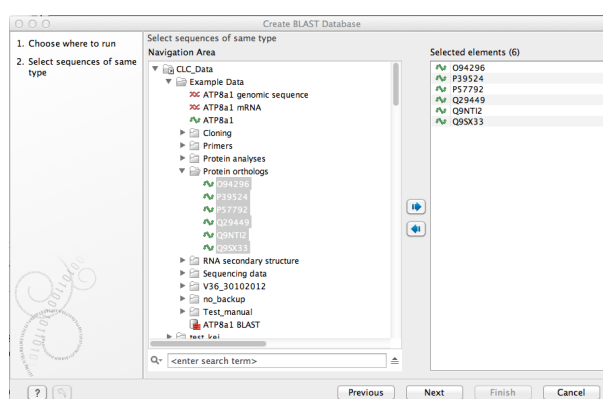

Figure 11.15: Add sequences for the BLAST database.

Select sequences or sequence lists you wish to include in your database and click **Next**.

In the next dialog, shown in figure 11.16, you provide the following information:

- **Name.** The name of the BLAST database. This name will be used when running BLAST searches and also as the base file name for the BLAST database files.
- **Description.** You can add more details to describe the contents of the database.
- **Location.** You can select the location to save the BLAST database files to. You can add or change the locations in this list using the **Manage BLAST Databases** tool, see section 11.4.

Click **Finish** to create the BLAST database. Once the process is complete, the new database will be available in the **Manage BLAST Databases** dialog, see section 11.4, and when running local BLAST (see section 11.1.3).

11.4 Manage BLAST databases

The BLAST databases available as targets for running local BLAST searches (see section 11.1.3) can be managed through the Manage BLAST Databases dialog (see figure 11.17):

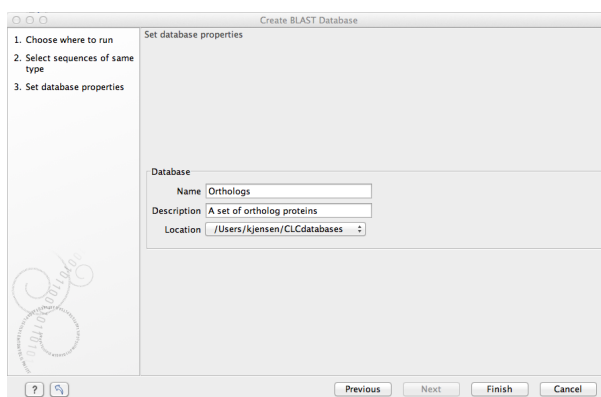

Figure 11.16: Providing a name and description for the database, and the location to save the files to.

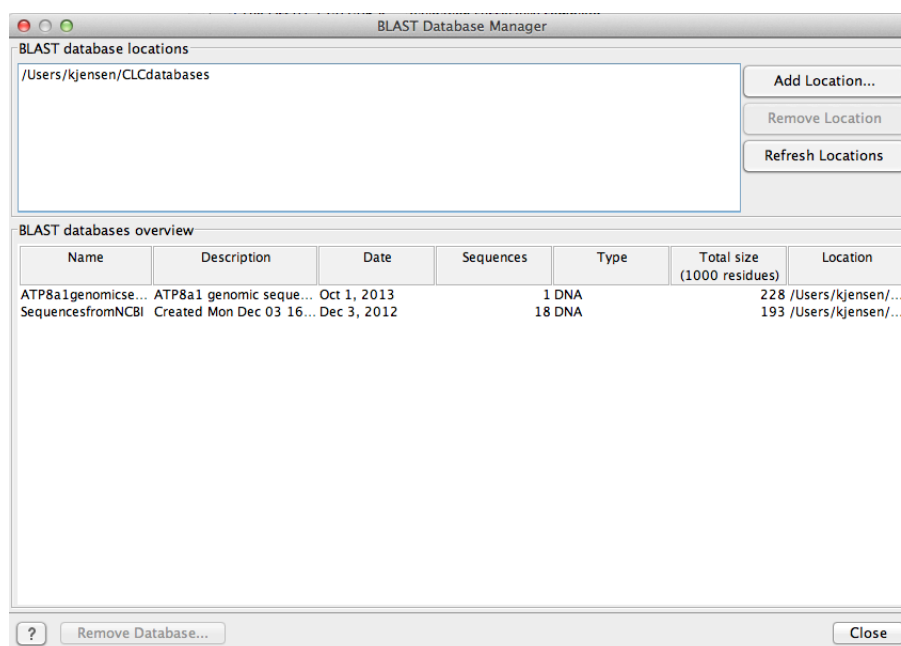

Figure 11.17: Overview of available BLAST databases.

Toolbox | BLAST (📁) | Manage BLAST Databases (🗑️)

At the top of the dialog, there is a list of the **BLAST database locations**. These locations are folders where the Workbench will look for valid BLAST databases. These can either be created from within the Workbench using the **Create BLAST Database tool**, see section 11.3.3, or they can be pre-formatted BLAST databases.

The list of locations can be modified using the **Add Location** and **Remove Location** buttons. Once the Workbench has scanned the locations, it will keep a cache of the databases (in order to improve performance). If you have added new databases that are not listed, you can press **Refresh Locations** to clear the cache and search the database locations again.

Note:The BLAST database location and all folders in its path should **not** have any spaces in their names on Linux or Mac systems.

By default a BLAST database location will be added under your home area in a folder called CLCdatabases. This folder is scanned recursively, through all subfolders, to look for valid

databases. All other folder locations are scanned only at the top level.

Below the list of locations, all the BLAST databases are listed with the following information:

- **Name.** The name of the BLAST database.
- **Description.** Detailed description of the contents of the database.
- **Date.** The date the database was created.
- **Sequences.** The number of sequences in the database.
- **Type.** The type can be either nucleotide (DNA) or protein.
- **Total size (1000 residues).** The number of residues in the database, either bases or amino acid.
- **Location.** The location of the database.

Below the list of BLAST databases, there is a button to **Remove Database**. This option will delete the database files belonging to the database selected.

11.5 Bioinformatics explained: BLAST

BLAST (Basic Local Alignment Search Tool) has become the *de facto* standard in search and alignment tools [Altschul et al., 1990]. The BLAST algorithm is still actively being developed and is one of the most cited papers ever written in this field of biology. Many researchers use BLAST as an initial screening of their sequence data from the laboratory and to get an idea of what they are working on. BLAST is far from being basic as the name indicates; it is a highly advanced algorithm which has become very popular due to availability, speed, and accuracy. In short, a BLAST search identifies homologous sequences by searching one or more databases usually hosted by NCBI (<http://www.ncbi.nlm.nih.gov/>), on the query sequence of interest [McGinnis and Madden, 2004].

BLAST is an open source program and anyone can download and change the program code. This has also given rise to a number of BLAST derivatives; WU-BLAST is probably the most commonly used [Altschul and Gish, 1996].

BLAST is highly scalable and comes in a number of different computer platform configurations which makes usage on both small desktop computers and large computer clusters possible.

11.5.1 Examples of BLAST usage

BLAST can be used for a lot of different purposes. A few of them are mentioned below.

- **Looking for species.** If you are sequencing DNA from unknown species, BLAST may help identify the correct species or homologous species.
- **Looking for domains.** If you BLAST a protein sequence (or a translated nucleotide sequence) BLAST will look for known domains in the query sequence.

- **Looking at phylogeny.** You can use the BLAST web pages to generate a phylogenetic tree of the BLAST result.
- **Mapping DNA to a known chromosome.** If you are sequencing a gene from a known species but have no idea of the chromosome location, BLAST can help you. BLAST will show you the position of the query sequence in relation to the hit sequences.
- **Annotations.** BLAST can also be used to map annotations from one organism to another or look for common genes in two related species.

11.5.2 Searching for homology

Most research projects involving sequencing of either DNA or protein have a requirement for obtaining biological information of the newly sequenced and maybe unknown sequence. If the researchers have no prior information of the sequence and biological content, valuable information can often be obtained using BLAST. The BLAST algorithm will search for homologous sequences in predefined and annotated databases of the users choice.

In an easy and fast way the researcher can gain knowledge of gene or protein function and find evolutionary relations between the newly sequenced DNA and well established data.

After the BLAST search the user will receive a report specifying found homologous sequences and their local alignments to the query sequence.

11.5.3 How does BLAST work?

BLAST identifies homologous sequences using a heuristic method which initially finds short matches between two sequences; thus, the method does not take the entire sequence space into account. After initial match, BLAST attempts to start local alignments from these initial matches. This also means that BLAST does not guarantee the optimal alignment, thus some sequence hits may be missed. In order to find optimal alignments, the Smith-Waterman algorithm should be used (see below). In the following, the BLAST algorithm is described in more detail.

Seeding

When finding a match between a query sequence and a hit sequence, the starting point is the *words* that the two sequences have in common. A word is simply defined as a number of letters. For blastp the default word size is 3 $W=3$. If a query sequence has a QWRTG, the searched words are QWR, WRT, RTG. See figure 11.18 for an illustration of words in a protein sequence.



Figure 11.18: Generation of exact BLAST words with a word size of $W=3$.

During the initial BLAST seeding, the algorithm finds all common words between the query

sequence and the hit sequence(s). Only regions with a word hit will be used to build on an alignment.

BLAST will start out by making words for the entire query sequence (see figure 11.18). For each word in the query sequence, a compilation of neighborhood words, which exceed the threshold of T , is also generated.

A neighborhood word is a word obtaining a score of at least T when comparing, using a selected scoring matrix (see figure 11.19). The default scoring matrix for blastp is BLOSUM62 (for explanation of scoring matrices, see www.clcbio.com/be). The compilation of exact words and neighborhood words is then used to match against the database sequences.

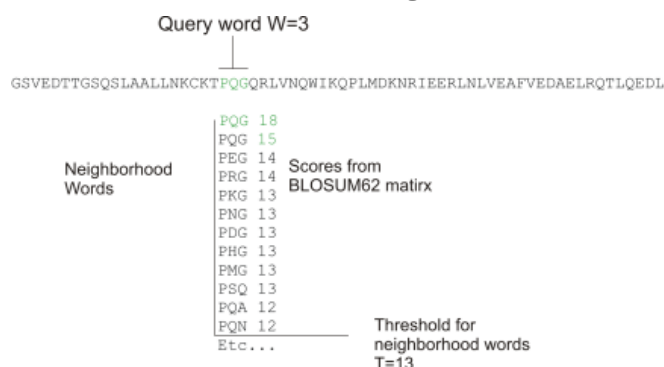

Figure 11.19: Neighborhood BLAST words based on the BLOSUM62 matrix. Only words where the threshold T exceeds 13 are included in the initial seeding.

After initial finding of words (seeding), the BLAST algorithm will extend the (only 3 residues long) alignment in both directions (see figure 11.20). Each time the alignment is extended, an alignment score is increases/decreased. When the alignment score drops below a predefined threshold, the extension of the alignment stops. This ensures that the alignment is not extended to regions where only very poor alignment between the query and hit sequence is possible. If the obtained alignment receives a score above a certain threshold, it will be included in the final BLAST result.

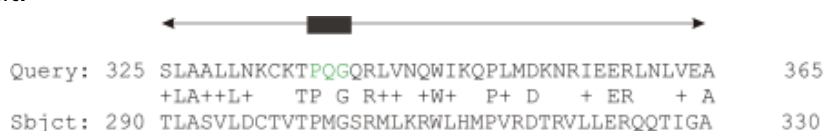

Figure 11.20: Blast aligning in both directions. The initial word match is marked green.

By tweaking the word size W and the neighborhood word threshold T , it is possible to limit the search space. E.g. by increasing T , the number of neighboring words will drop and thus limit the search space as shown in figure 11.21.

This will increase the speed of BLAST significantly but may result in loss of sensitivity. Increasing the word size W will also increase the speed but again with a loss of sensitivity.

11.5.4 Which BLAST program should I use?

Depending on the nature of the sequence it is possible to use different BLAST programs for the database search. There are five versions of the BLAST program, blastn, blastp, blastx, tblastn, tblastx:

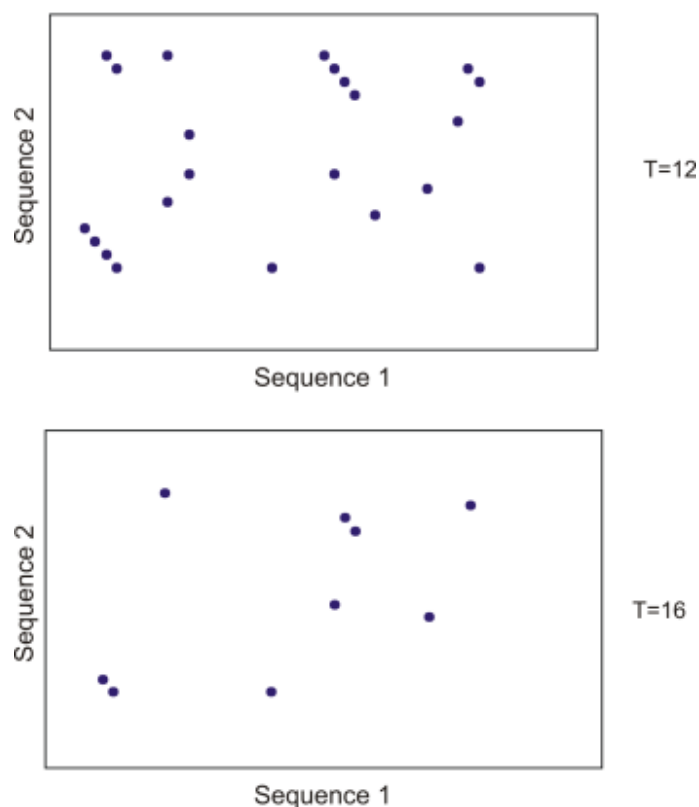

Figure 11.21: Each dot represents a word match. Increasing the threshold of T limits the search space significantly.

Option	Query Type	DB Type	Comparison	Note
blastn	Nucleotide	Nucleotide	Nucleotide-Nucleotide	
blastp	Protein	Protein	Protein-Protein	
tblastn	Protein	Nucleotide	Protein-Protein	The database is translated into protein
blastx	Nucleotide	Protein	Protein-Protein	The queries are translated into protein
tblastx	Nucleotide	Nucleotide	Protein-Protein	The queries and database are translated into protein

The most commonly used method is to BLAST a nucleotide sequence against a nucleotide database (blastn) or a protein sequence against a protein database (blastp). But often another BLAST program will produce more interesting hits. E.g. if a nucleotide sequence is translated before the search, it is more likely to find better and more accurate hits than just a blastn search. One of the reasons for this is that protein sequences are evolutionarily more conserved than nucleotide sequences. Another good reason for translating the query sequence before the search is that you get protein hits which are likely to be annotated. Thus you can directly see the protein function of the sequenced gene.

11.5.5 Which BLAST options should I change?

The NCBI BLAST web pages and the BLAST command line tool offer a number of different options which can be changed in order to obtain the best possible result. Changing these parameters

can have a great impact on the search result. It is not the scope of this document to comment on all of the options available but merely the options which can be changed with a direct impact on the search result.

The E-value

The *expect value* (E-value) can be changed in order to limit the number of hits to the most significant ones. The lower the E-value, the better the hit. The E-value is dependent on the length of the query sequence and the size of the database. For example, an alignment obtaining an E-value of 0.05 means that there is a 5 in 100 chance of occurring by chance alone.

E-values are very dependent on the query sequence length and the database size. Short identical sequence may have a high E-value and may be regarded as "false positive" hits. This is often seen if one searches for short primer regions, small domain regions etc. The default threshold for the E-value on the BLAST web page is 10. Increasing this value will most likely generate more hits. Below are some rules of thumb which can be used as a guide but should be considered with common sense.

- **E-value < 10e-100** Identical sequences. You will get long alignments across the entire query and hit sequence.
- **10e-100 < E-value < 10e-50** Almost identical sequences. A long stretch of the query protein is matched to the database.
- **10e-50 < E-value < 10e-10** Closely related sequences, could be a domain match or similar.
- **10e-10 < E-value < 1** Could be a true homologue but it is a gray area.
- **E-value > 1** Proteins are most likely not related
- **E-value > 10** Hits are most likely junk unless the query sequence is very short.

Gap costs

For blastp it is possible to specify gap cost for the chosen substitution matrix. There is only a limited number of options for these parameters. The *open gap cost* is the price of introducing gaps in the alignment, and *extension gap cost* is the price of every extension past the initial opening gap. Increasing the gap costs will result in alignments with fewer gaps.

Filters

It is possible to set different filter options before running the BLAST search. Low-complexity regions have a very simple composition compared to the rest of the sequence and may result in problems during the BLAST search [Wootton and Federhen, 1993]. A low complexity region of a protein can for example look like this 'fftflllsss', which in this case is a region as part of a signal peptide. In the output of the BLAST search, low-complexity regions will be marked in lowercase gray characters (default setting). The low complexity region cannot be thought of as a significant match; thus, disabling the low complexity filter is likely to generate more hits to sequences which are not truly related.

Word size

Change of the word size has a great impact on the seeded sequence space as described above. But one can change the word size to find sequence matches which would otherwise not be found using the default parameters. For instance the word size can be decreased when searching for primers or short nucleotides. For `blastn` a suitable setting would be to decrease the default word size of 11 to 7, increase the E-value significantly (1000) and turn off the complexity filtering.

For `blastp` a similar approach can be used. Decrease the word size to 2, increase the E-value and use a more stringent substitution matrix, e.g. a PAM30 matrix.

Fortunately, the optimal search options for finding short, nearly exact matches can already be found on the BLAST web pages <http://www.ncbi.nlm.nih.gov/BLAST/>.

Substitution matrix

For protein BLAST searches, a default substitution matrix is provided. If you are looking at distantly related proteins, you should either choose a high-numbered PAM matrix or a low-numbered BLOSUM matrix. See *Bioinformatics Explained* on scoring matrices on <http://www.clcbio.com/be/>. The default scoring matrix for `blastp` is BLOSUM62.

11.5.6 Explanation of the BLAST output

The BLAST output comes in different flavors. On the NCBI web page the default output is html, and the following description will use the html output as example. Ordinary text and xml output for easy computational parsing is also available.

The default layout of the NCBI BLAST result is a graphical representation of the hits found, a table of sequence identifiers of the hits together with scoring information, and alignments of the query sequence and the hits.

The graphical output (shown in figure 11.22) gives a quick overview of the query sequence and the resulting hit sequences. The hits are colored according to the obtained alignment scores.

The table view (shown in figure 11.23) provides more detailed information on each hit and furthermore acts as a hyperlink to the corresponding sequence in GenBank.

In the alignment view one can manually inspect the individual alignments generated by the BLAST algorithm. This is particularly useful for detailed inspection of the sequence hit found (subject) and the corresponding alignment. In the alignment view, all scores are described for each alignment, and the start and stop positions for the query and hit sequence are listed. The strand and orientation for query sequence and hits are also found here.

In most cases, the table view of the results will be easier to interpret than tens of sequence alignments.

11.5.7 I want to BLAST against my own sequence database, is this possible?

It is possible to download the entire BLAST program package and use it on your own computer, institution computer cluster or similar. This is preferred if you want to search in proprietary sequences or sequences unavailable in the public databases stored at NCBI. The downloadable BLAST package can either be installed as a web-based tool or as a command line tool. It is

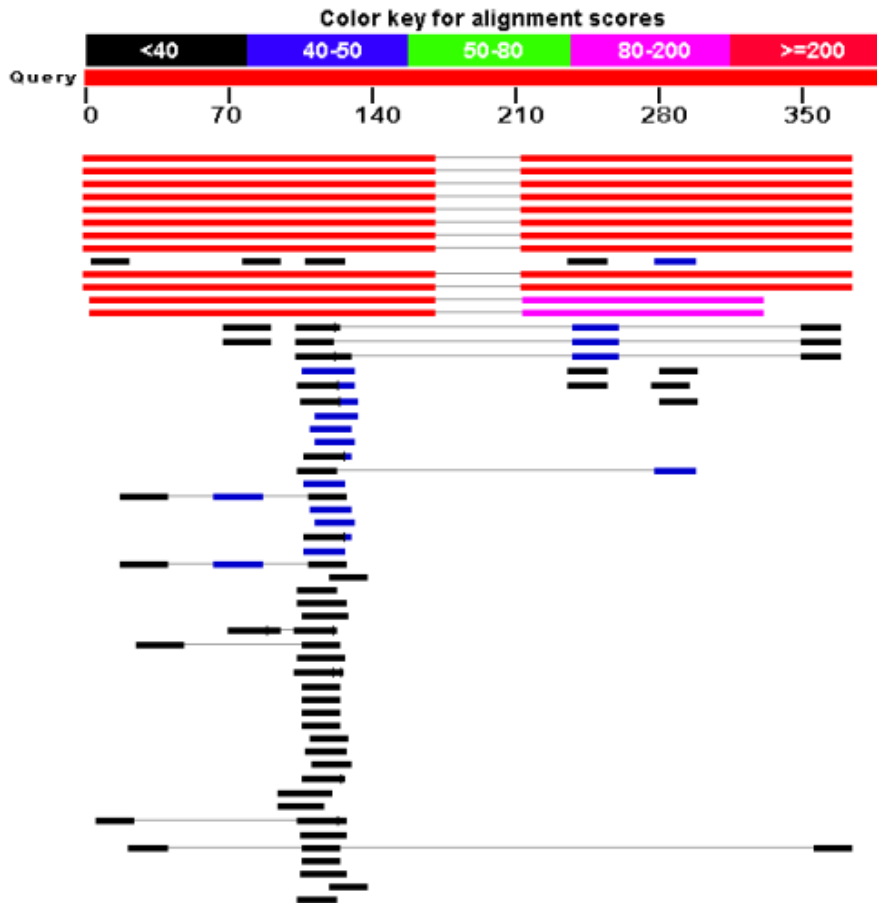

Figure 11.22: BLAST graphical view. A simple graphical overview of the hits found aligned to the query sequence. The alignments are color coded ranging from black to red as indicated in the color label at the top.

Sequences producing significant alignments:
(ID16X header to 40th column)

Accession	Description	Max score	Total score	Query coverage	E value	Max ident	Links
NM_171888.1	Homo sapiens tumor-induced factor (TAUF family homeobox) (TF2F)	222	563	85%	1e-90	100%	U L G M
NM_171890.1	Homo sapiens TGFβ-induced factor (TAUF family homeobox) (TGIF)	229	563	85%	1e-90	100%	U L G M
NM_171892.1	Homo sapiens TGFβ-induced factor (TAUF family homeobox) (TGIF)	222	563	85%	1e-90	100%	U L G M
NM_171894.1	Homo sapiens TGFβ-induced factor (TAUF family homeobox) (TGIF)	222	563	85%	1e-90	100%	U L G M
NM_171896.1	Homo sapiens TGFβ-induced factor (TAUF family homeobox) (TGIF)	222	563	85%	1e-90	100%	U L G M
NM_171898.1	Homo sapiens TGFβ-induced factor (TAUF family homeobox) (TGIF)	229	563	85%	1e-90	100%	U L G M
NM_171900.1	Homo sapiens TGFβ-induced factor (TAUF family homeobox) (TGIF)	229	563	85%	1e-90	100%	U L G M
NM_003244.2	Homo sapiens TGFβ-induced factor (TAUF family homeobox) (TGIF)	229	563	85%	1e-90	100%	U L G M
NM_003246.2	Homo sapiens chromodomain 1 (THO21), mRNA	20.2	20.2	4%	7.2	100%	U L G M
NM_171962.2	Homo sapiens chromosome 8 open reading frame 37 (COR37)	20.2	20.2	4%	7.2	100%	U L G M
Genomic sequences (tblastn)							
NC_018852.13	Homo sapiens chromosome 18 genomic contig, reference assembly	222	602	85%	1e-90	100%	
NW_820920.1	Homo sapiens chromosome 18 genomic contig, alternate assembly	222	602	85%	1e-90	100%	
NC_011189.19	Homo sapiens chromosome 19 genomic contig, reference assembly	282	375	73%	3e-67	94%	
NW_923217.1	Homo sapiens chromosome 19 genomic contig, alternate assembly	282	375	73%	3e-67	94%	

Figure 11.23: BLAST table view. A table view with one row per hit, showing the accession number and description field from the sequence file together with BLAST output scores.

available for a wide range of different operating systems.

The BLAST package can be downloaded free of charge from the following location <http://www.ncbi.nlm.nih.gov/BLAST/download.shtml>

Pre-formatted databases are available from a dedicated BLAST ftp site <ftp://ftp.ncbi.nlm.nih.gov/blast/db/>. Moreover, it is possible to download programs/scripts from the same site enabling automatic download of changed BLAST databases. Thus it is possible to schedule a nightly update of changed databases and have the updated BLAST database stored locally or on a shared network drive at all times. Most BLAST databases on the NCBI site are updated on

```

> [ref|NM_173209.1] UEGM Homo sapiens TGFB-induced factor (TALE family homeobox) (TGIF),
transcript variant 5, mRNA
Length=1382

Sort alignments for this subject sequence by:
E value  Score  Percent identity
Query start position  Subject start position

Score = 339 bits (171), Expect = 1e-90
Identities = 171/171 (100%), Gaps = 0/171 (0%)
Strand=Plus/Plus

Query 1  ATTTGCACATGGGATTGCTAAACAGCTTCCTGTTACTGAGATGTCCTCAATGGAATACA 60
      |
      |
      |
Sbjct 993 ATTTGCACATGGGATTGCTAAACAGCTTCCTGTTACTGAGATGTCCTCAATGGAATACA 1052

Query 61  GTCATCCCAAGAACTATAAACTTAAAGCTACTGTAGAAACAAAGGGTTTTCTTTTTTAAA 120
      |
      |
      |
Sbjct 1053 GTCATCCCAAGAACTATAAACTTAAAGCTACTGTAGAAACAAAGGGTTTTCTTTTTTAAA 1112

Query 121 TGTTCCTTGGTAGAATTATTCATAATGTGAGATGGITCCCAATATCATGTGA 171
      |
      |
      |
Sbjct 1113 TGTTCCTTGGTAGAATTATTCATAATGTGAGATGGITCCCAATATCATGTGA 1163

Score = 224 bits (113), Expect = 6e-56
Identities = 161/161 (100%), Gaps = 0/161 (0%)
Strand=Plus/Plus

Query 213  GACTGTGCAATACCTTAGAGAACCTATAGCATCTTCTCATTCCCATGTGGAAACAGGATGCC 272
      |
      |
      |
Sbjct 1205  GACTGTGCAATACCTTAGAGAACCTATAGCATCTTCTCATTCCCATGTGGAAACAGGATGCC 1264

Query 273  CACATACGTCTAATTATAAAATTTTCCAccccccccCAAAACAAGTATGAATCTAGTTGG 332
      |
      |
      |
Sbjct 1265  CACATACGTCTAATTATAAAATTTTCCATTTTTTTTCAAAACAAGTATGAATCTAGTTGG 1324

Query 333  TTGATGCCccccccccCATGACATAATAAGTATTTTCTTT 373
      |
      |
      |
Sbjct 1325  TTGATGCCTTTTTTTTTTCATGACATAATAAGTATTTTCTTT 1365

```

Figure 11.24: Alignment view of BLAST results. Individual alignments are represented together with BLAST scores and more.

a daily basis to include all recent sequence submissions to GenBank.

A few commercial software packages are available for searching your own data. The advantage of using a commercial program is obvious when BLAST is integrated with the existing tools of these programs. Furthermore, they let you perform BLAST searches and retain annotations on the query sequence (see figure 11.25). It is also much easier to batch download a selection of hit sequences for further inspection.

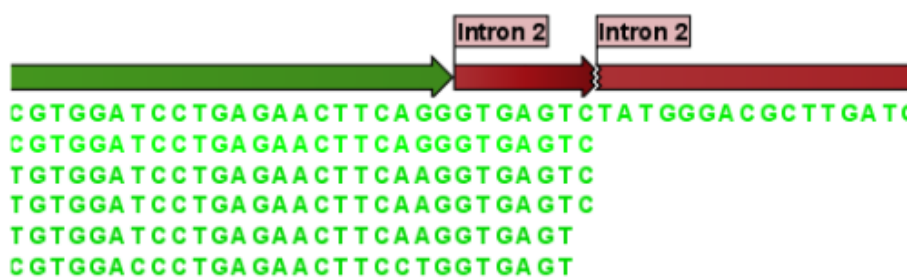

Figure 11.25: Snippet of alignment view of BLAST results from CLC Main Workbench. Individual alignments are represented directly in a graphical view. The top sequence is the query sequence and is shown with a selection of annotations.

11.5.8 What you cannot get out of BLAST

Don't expect BLAST to produce the best available alignment. BLAST is a heuristic method which does not guarantee the best results, and therefore you cannot rely on BLAST if you wish to find

all the hits in the database.

Instead, use the Smith-Waterman algorithm for obtaining the best possible local alignments [Smith and Waterman, 1981].

BLAST only makes local alignments. This means that a great but short hit in another sequence may not at all be related to the query sequence even though the sequences align well in a small region. It may be a domain or similar.

It is always a good idea to be cautious of the material in the database. For instance, the sequences may be wrongly annotated; hypothetical proteins are often simple translations of a found ORF on a sequenced nucleotide sequence and may not represent a true protein.

Don't expect to see the best result using the default settings. As described above, the settings should be adjusted according to the what kind of query sequence is used, and what kind of results you want. It is a good idea to perform the same BLAST search with different settings to get an idea of how they work. There is not a final answer on how to adjust the settings for your particular sequence.

11.5.9 Other useful resources

The BLAST web page hosted at NCBI

<http://www.ncbi.nlm.nih.gov/BLAST>

Download pages for the BLAST programs

<http://www.ncbi.nlm.nih.gov/BLAST/download.shtml>

Download pages for pre-formatted BLAST databases

<ftp://ftp.ncbi.nlm.nih.gov/blast/db/>

O'Reilly book on BLAST

<http://www.oreilly.com/catalog/blast/>

Explanation of scoring/substitution matrices and more

<http://www.clcbio.com/be/>

Chapter 12

3D Molecule Viewer

Contents

12.1 Importing molecule structure files	284
12.1.1 From the Protein Data Bank	285
12.1.2 From your own file system	285
12.1.3 BLAST search against the PDB database	286
12.1.4 Import issues	287
12.2 Viewing molecular structures in 3D	288
12.2.1 Moving and rotating	288
12.2.2 Troubleshooting 3D graphics errors	289
12.2.3 Updating old structure files	290
12.3 Customizing the visualization	290
12.3.1 Visualization styles and colors	291
12.3.2 Project settings	297
12.4 Snapshots of the molecule visualization	299
12.5 Tools for linking sequence and structure	299
12.5.1 Show sequence associated with molecule	300
12.5.2 Link sequence or sequence alignment to structure	300
12.5.3 Transfer annotations between sequence and structure	301
12.6 Protein structure alignment	303
12.6.1 The Align Protein Structure dialog box	303
12.6.2 Example: alignment of calmodulin	304
12.6.3 The Align Protein Structure algorithm	305

Proteins are amino acid polymers that are involved in all aspects of cellular function. The structure of a protein is defined by its particular amino acid sequence, with the amino acid sequence being referred to as the primary protein structure. The amino acids fold up in local structural elements; helices and sheets, also called the secondary structure of the protein. These structural elements are then packed into globular folds, known as the tertiary structure or the three dimensional structure.

In order to understand protein function it is often valuable to see the three dimensional structure of the protein. This is possible when the structure of the protein has been resolved and published.

Structure files are usually deposited in the Protein Data Bank (PDB) <http://www.rcsb.org/>, where the publicly available protein structure files can be searched and downloaded. The vast majority of the protein structures have been determined by X-ray crystallography (88%) while the rest of the structures predominantly have been obtained by Nuclear Magnetic Resonance techniques.

In addition to protein structures, the PDB entries also contain structural information about molecules that interact with the protein, such as nucleic acids, ligands, cofactors, and water. There are also entries, which contain nucleic acids and no protein structure. The **3D Molecule Viewer** in the *CLC Genomics Workbench* is an integrated viewer of such structure files.

The **3D Molecule Viewer** offers a range of tools for inspection and visualization of molecular structures:

- Automatic sorting of molecules into categories: Proteins, Nucleic acids, Ligands, Cofactors, Water molecules
- Hide/unhide individual molecules from the view
- Four different atom-based molecule visualizations
- Backbone visualization for proteins and nucleic acids
- Molecular surface visualization
- Selection of different color schemes for each molecule visualization
- Customized visualization for user selected atoms
- Alignment of protein structures
- Browse amino acids and nucleic acids from sequence editors started from within the 3D Molecule Viewer
- Link a sequence or alignment to a protein structure
- Transfer annotations between the linked sequence and the structure

12.1 Importing molecule structure files

The supported file format for three dimensional protein structures in the **3D Molecule Viewer**, is the Protein Data Bank (PDB) format, which upon import is converted to a CLC Molecule Project. PDB files can be imported to a Molecule Project in three different ways:

- **From the Protein Data Bank** (12.1.1)
- **From your own file system** (12.1.2)
- **Using BLAST search against the PDB database** (12.1.3)

12.1.1 From the Protein Data Bank

Molecule structures can be imported in the workbench from the Protein Data Bank using the "Download" function:

Toolbar | Download (📄) | Search for PDB structures at NCBI (🔍)

Type the molecule name or accession number into the search field and click on the "Start search" button (as shown in figure 12.1). The search hits will appear in the table below the search field.

Select the molecule structure of interest and click on the button labeled "Download and Open" (see figure 12.1) or double click on the relevant row in the table to open the protein structure.

Pressing the "Download and Save" button will save the molecule structure at a user defined destination in the **Navigation Area**.

The button "Open at NCBI" links directly to the structure summary page at NCBI. Clicking this button will open individual NCBI pages describing each of the selected molecule structures.

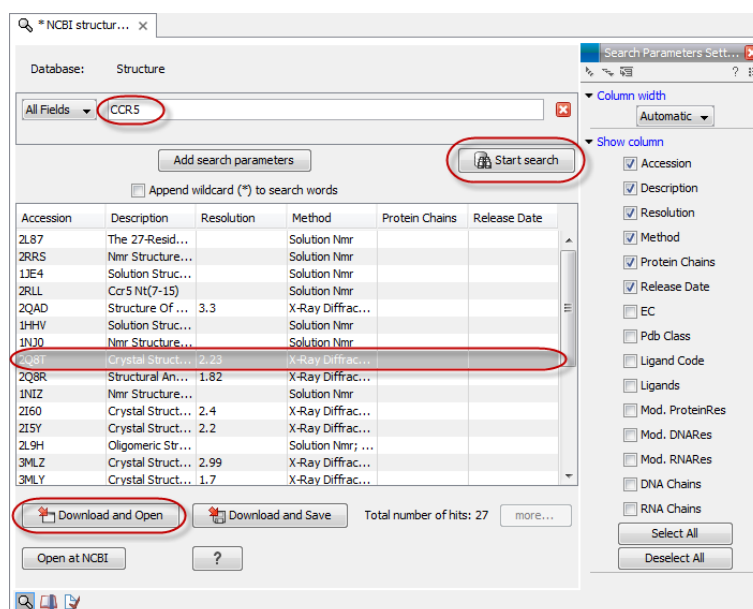

Figure 12.1: Download protein structure from the Protein Data Bank. It is possible to open a structure file directly from the output of the search by clicking the "Download and Open" button or by double clicking directly on the relevant row.

12.1.2 From your own file system

A PDB file can also be imported from your own file system using the standard import function:

Toolbar | Import (📄) | Standard Import (📄)

In the Import dialog, select the structure(s) of interest from a data location and tick "Automatic import" (figure 12.2). Specify where to save the imported PDB file and click **Finish**.

Double clicking on the imported file in the **Navigation Area** will open the structure as a **Molecule Project** in the **View Area** of the *CLC Genomics Workbench*. Another option is to drag the PDB file from the **Navigation Area** to the **View Area**. This will automatically open the protein structure as a **Molecule Project**.

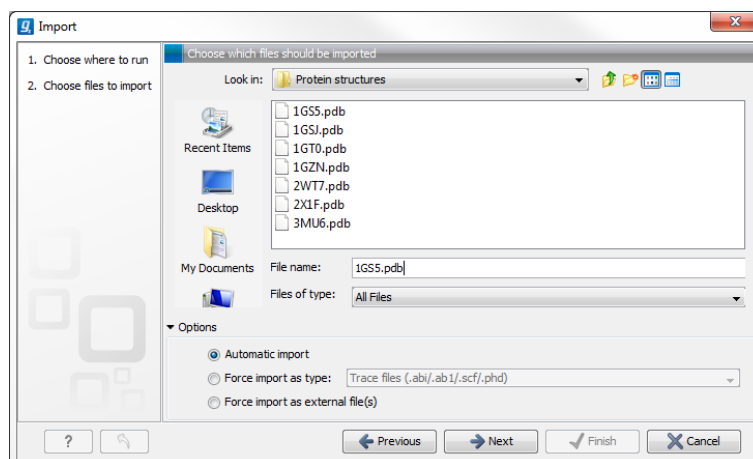

Figure 12.2: A PDB file can be imported using the "Standard Import" function.

12.1.3 BLAST search against the PDB database

It is also possible to make a BLAST search against the PDB database, by going to:

Toolbox | BLAST (📄) | **BLAST at NCBI** (🌐)

After selecting where to run the analysis, specify which input sequences to use for the BLAST search in the "BLAST at NCBI" dialog, within the box named "Select sequences of same type". More than one sequence can be selected at the same time, as long as the sequences are of the same type (figure 12.3).

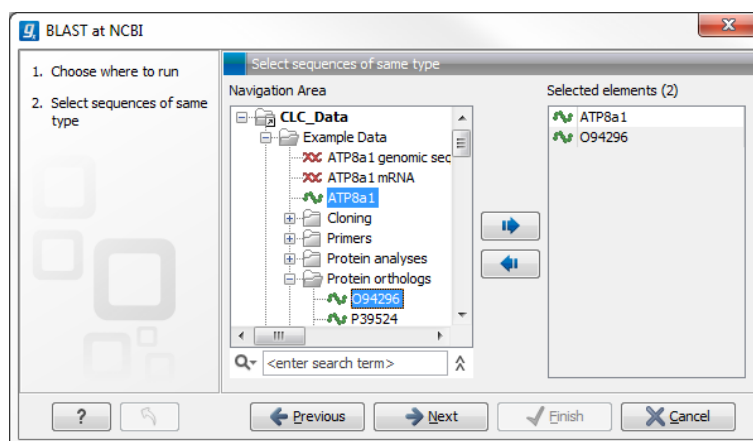

Figure 12.3: Select the input sequence of interest. In this example a protein sequence for ATPase class I type 8A member 1 and an ATPase ortholog from *S. pombe* have been selected.

Click **Next** and choose program and database (figure 12.4). When a protein sequence has been used as input, select "Program: blastp: Protein sequence and database" and "Database: Protein Data Bank proteins (pdb)".

It is also possible to use mRNA and genomic sequences as input. In such cases the program "blastx: Translated DNA sequence and protein database" should be used.

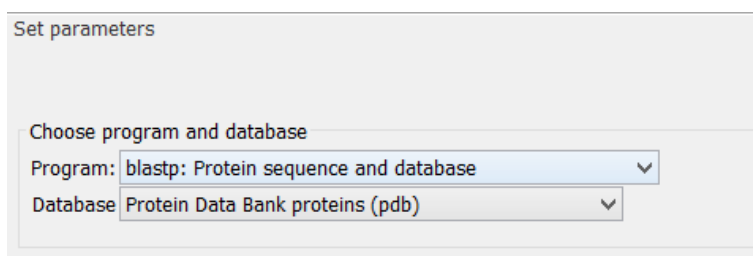

Figure 12.4: Select database and program.

Please refer to section 11.1.1 for further description of the individual parameters in the wizard steps.

When you click on the button labeled **Finish**, a BLAST output is generated that shows local sequence alignments between your input sequence and a list of matching proteins with known structures available.

Note! The BLAST at NCBI search can take up to several minutes, especially when mRNA and genomic sequences are used as input.

Switch to the "BLAST Table" editor view to select the desired entry (figure 12.5). If you have performed a multi BLAST, to get access to the "BLAST Table" view, you must first double click on each row to open the entries individually.

In this view four different options are available:

- **Download and Open** The sequence that has been selected in the table is downloaded and opened in the **View Area**.
- **Download and Save** The sequence that has been selected in the table is downloaded and saved in the **Navigation Area**.
- **Open at NCBI** The protein sequence that has been selected in the table is opened at NCBI.
- **Open Structure** Opens the selected structure in a **Molecule Project** in the **View Area**.

12.1.4 Import issues

When opening an imported molecule file for the first time, a notification is briefly shown in the lower left corner of the **Molecule Project** editor, with information of the number of issues encountered during import of the file. The issues are categorized and listed in a table view in the Issues view. The Issues list can be opened by selecting **Show | Issues** from the menu appearing when right-clicking in an empty space in the 3D view (figure 12.6).

Alternatively, the issues can be accessed from the lower left corner of the view, where buttons are shown for each available view. If you hold down the Ctrl key (Cmd on Mac) while clicking on the Issues icon (🔍), the list will be shown in a split view together with the 3D view. The issues list is linked with the molecules in the 3D view, such that selecting an entry in the list will select the implicated atoms in the view, and zoom to put them into the center of the 3D view.

The screenshot displays the BLAST interface. The top window shows a sequence alignment for query ATP8a1 against several database sequences. The alignment is color-coded by identity, with a scale from 40% to 100% shown in the 'BLAST Settings' panel. The bottom window shows a table of hits with columns for Hit, Description, E-value, Score, and %Gaps. The row for '2DQS_A' is selected, and four buttons ('Download and Open', 'Download and Save', 'Open at NCBI', 'Open Structure') are visible below the table. The 'BLAST Table Settings' panel on the right shows various options for displaying the table.

Hit	Description	E-value	Score	%Gaps
3TLM_A	Chain A, Crystal Structure Of Endoplasmic Reticulum Ca2+-ATPase (Serca) From Bovine Musc...	1.20E-8	143.00	20.00
1KJU_A	Chain A, Ca2+-ATPase In The E2 State >g 25200158 pdb 1IWO A Chain A, Crystal Structure ...	3.03E-8	139.00	23.00
2DQS_A	Chain A, Crystal Structure Of The Calcium Pump With Ampcp In The Absence Of Calcium >g 3...	3.03E-8	139.00	23.00
3W5B_A	Chain A, Crystal Structure Of The Recombinant Serca 1a (calcium Pump Of Fast Twitch Skeletal ...	3.03E-8	139.00	23.00
3IXZ_A	Chain A, Pig Gastric H+K+-ATPase Complexed With Aluminium Fluoride >g 320089708 pdb 2ZK...	2.21E-7	132.00	16.00
3IXZ_A	Chain A, Pig Gastric H+K+-ATPase Complexed With Aluminium Fluoride >g 320089708 pdb 2ZK...	0.17	82.00	6.00
3BA6_A	Chain A, Structure Of The Ca2+ Phosphoenzyme Intermediate Of The Serca Ca2+-ATPase	2.46E-7	132.00	23.00
3B8E_A	Chain A, Crystal Structure Of The Sodium-Potassium Pump >g 163311039 pdb 3B8E C Chain C...	2.31E-4	106.00	6.00
3B8E_A	Chain A, Crystal Structure Of The Sodium-Potassium Pump >g 163311039 pdb 3B8E C Chain C...	0.15	82.00	10.00
3N23_A	Chain A, Crystal Structure Of The High Affinity Complex Between Ouabain And The E2p Form O...	2.38E-4	106.00	6.00
3N23_A	Chain A, Crystal Structure Of The High Affinity Complex Between Ouabain And The E2p Form O...	0.17	82.00	10.00
2ZXE_A	Chain A, Crystal Structure Of The Sodium - Potassium Pump In The E2.2k+Pi State >g 257471...	1.61E-3	99.00	14.00
2ZXE_A	Chain A, Crystal Structure Of The Sodium - Potassium Pump In The E2.2k+Pi State >g 257471...	3.76E-3	96.00	6.00
2HC8_A	Chain A, Structure Of The A. Fulgidus Copa A-Domain >g 238537685 pdb 2VOY F Chain F, Cr...	0.01	85.00	8.00
3109_A	Chain A, High Resolution Helical Reconstruction Of The Bacterial P-Type ATPase Copper Transp...	0.02	90.00	8.00
3109_A	Chain A, High Resolution Helical Reconstruction Of The Bacterial P-Type ATPase Copper Transp...	3.06	71.00	4.00
3109_A	Chain A, High Resolution Helical Reconstruction Of The Bacterial P-Type ATPase Copper Transp...	0.02	90.00	8.00
3109_A	Chain A, High Resolution Helical Reconstruction Of The Bacterial P-Type ATPase Copper Transp...	3.44	71.00	4.00
3RFU_A	Chain A, Crystal Structure Of A Copper-Transporting Pib-Type ATPase >g 340708460 pdb 3RF...	0.06	86.00	16.00
1MHS_A	Chain A, Model Of Neurospora Crassa Proton ATPase >g 24159071 pdb 1MHS B Chain B, Mod...	0.39	79.00	29.00
2W0M_A	Chain A, Crystal Structure Of Sso2452 From Sulfolobus Solfataricus P2	0.46	76.00	3.00
3P96_A	Chain A, Crystal Structure Of Phosphoserine Phosphatase Serb From Mycobacterium Avium, Na...	0.51	77.00	6.00
2RAR_A	Chain A, X-Ray Crystallographic Structures Show Conservation Of A Trigonal-Bipyramidal Inter...	0.56	76.00	7.00
3M1Y_A	Chain A, Crystal Structure Of A Phosphoserine Phosphatase (Serb) From Helicobacter Pylori >g ...	0.76	74.00	0.00

Figure 12.5: Top: The output from "BLAST at NCBI". Bottom: The "BLAST table". One of the protein sequences has been selected. This activates the four buttons under the table. Note that the table and the BLAST Graphics are linked, this means that when a sequence is selected in the table, the same sequence will be highlighted in the BLAST Graphics view.

12.2 Viewing molecular structures in 3D

An example of a 3D structure that has been opened as a **Molecule Project** is shown in figure 12.7.

12.2.1 Moving and rotating

The molecules can be rotated by holding down the left mouse button while moving the mouse. The right mouse button can be used to move the view.

Zooming can be done with the scroll-wheel or by holding down both left and right buttons while moving the mouse up and down.

All molecules in the **Molecule Project** are listed in categories in the **Project Tree**. The individual molecules or whole categories can be hidden from the view by un-checking the boxes next to them.

It is possible to bring a particular molecule or a category of molecules into focus by selecting the molecule or category of interest in the **Project Tree** view and double-click on the molecule or category of interest. Another option is to use the zoom-to-fit button (↔) at the bottom of the **Project Tree** view.

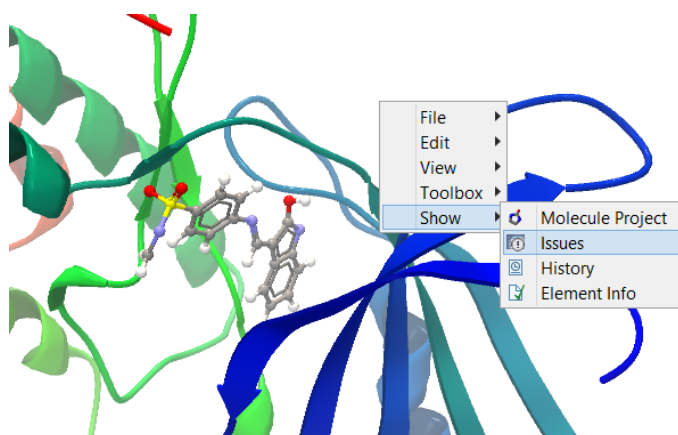

Figure 12.6: At the bottom of the Molecule Project it is possible to switch to the "Show Issues" view by clicking on the "table-with-exclamation-mark" icon.

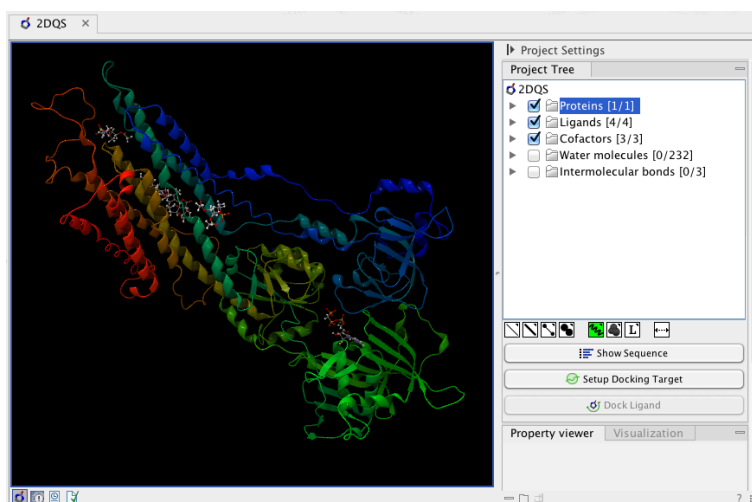

Figure 12.7: 3D view of a calcium ATPase. All molecules in the PDB file are shown in the Molecule Project. The Project Tree in the right side of the window lists the involved molecules.

12.2.2 Troubleshooting 3D graphics errors

The 3D viewer uses OpenGL graphics hardware acceleration in order to provide the best possible experience. If you experience any graphics problems with the 3D view, please make sure that the drivers for your graphics card are up-to-date.

If the problems persist after upgrading the graphics card drivers, it is possible to change to a rendering mode, which is compatible with a wider range of graphic cards. To change the graphics mode go to Edit in the menu bar, select "Preferences", Click on "View", scroll down to the bottom and find "Molecule Project 3D Editor" and uncheck the box "Use modern OpenGL rendering".

Finally, it should be noted that certain types of visualization are more demanding than others. In particular, using multiple molecular surfaces may result in slower drawing, and even result in the graphics card running out of available memory. Consider creating a single combined surface (by using a selection) instead of creating surfaces for each single object. For molecules with a large number of atoms, changing to wireframe rendering and hiding hydrogen atoms can also greatly improve drawing speed.

12.2.3 Updating old structure files

A completely redesign of the 3D Molecule Viewer was released in August 2013. It is therefore necessary to update older structure files. To update existing structure files, double click on the name in the **Navigation Area**. This will bring up the dialog shown in figure 12.8, which via the "Download from PDB..." button gives access to downloading the specific structure in PDB format.

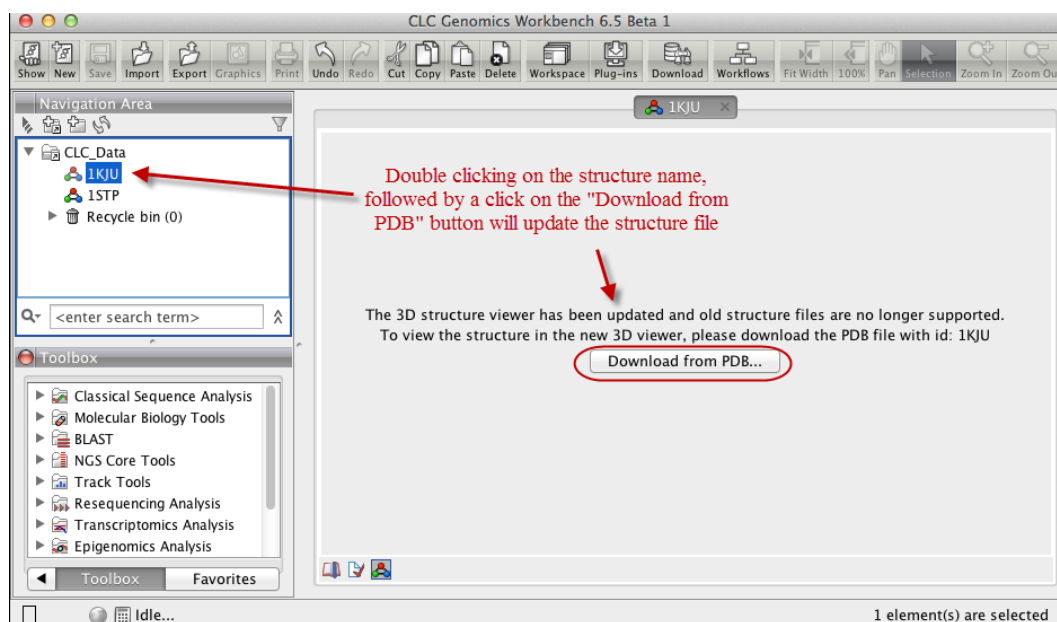

Figure 12.8: Old structure files are not supported by the new 3D Molecule Viewer and must be updated.

12.3 Customizing the visualization

The molecular visualization of all molecules in the Molecule Project can be customized using different visualization styles. The styles can be applied to one molecule at a time, or to a whole category (or a mixture), by selecting the name of either the molecule or the category. Holding down the Ctrl (Cmd on Mac) or shift key while clicking the entry names in the **Project Tree** will select multiple molecules/categories.

The six leftmost quick-style buttons below the **Project Tree** view give access to the molecule visualization styles, while context menus on the buttons (accessible via right-click or left-click-hold) give access to the color schemes available for the visualization styles. Visualization styles and color schemes are also available from context menus directly on the selected entries in the **Project Tree**. Other quick-style buttons are available for displaying hydrogen bonds between Project Tree entries, for displaying labels in the 3D view and for creating custom atom groups. They are all described in detail below.

Note! Whenever you wish to change the visualization styles by right-clicking the entries in the **Project Tree**, please be aware that you must first click on the entry of interest, and ensure it is highlighted in blue, before right-clicking.

12.3.1 Visualization styles and colors

Wireframe, Stick, Ball and stick, Space-filling/CPK

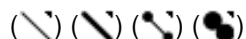

Four different ways of visualizing molecules by showing all atoms are provided: Wireframe, Stick, Ball and stick, and Space-filling/CPK.

The visualizations are mutually exclusive meaning that only one style can be applied at a time for each selected molecule or atom group.

Six color schemes are available and can be accessed via right-clicking on the quick-style buttons:

- Color by Element. Classic CPK coloring based on atom type (e.g. oxygen red, carbon gray, hydrogen white, nitrogen blue, sulfur yellow).
- Color by Temperature. For PDB files, this is based on the b-factors. For structure models created with tools in a CLC workbench, this is based on an estimate of the local model quality. The color scale goes from blue (0) over white (50) to red (100). The b-factors as well as the local model quality estimate are measures of uncertainty or disorder in the atom position; the higher the number, the higher the uncertainty.
- Color Carbons by Entry. Each entry (molecule or atom group) is assigned its own specific color. Only carbon atoms are colored by the specific color, other atoms are colored by element.
- Color by Entry. Each entry (molecule or atom group) is assigned its own specific color.
- Custom Color. The user selects a molecule color from a palette.
- Custom Carbon Color. The user selects a molecule color from a palette. Only carbon atoms are colored by the specific color, other atoms are colored by element.

Backbone



For the molecules in the Proteins and Nucleic Acids categories, the backbone structure can be visualized in a schematic rendering, highlighting the secondary structure elements for proteins and matching base pairs for nucleic acids. The backbone visualization can be combined with any of the atom-level visualizations.

Five color schemes are available for backbone structures:

- Color by Residue Position. Rainbow color scale going from blue over green to yellow and red, following the residue number.
- Color by Type. For proteins, beta sheets are blue, helices red and loops/coil gray. For nucleic acids backbone ribbons are white while the individual nucleotides are indicated in green (T/U), red (A), yellow (G), and blue (C).
- Color by Backbone Temperature. For PDB files, this is based on the b-factors for the $C\alpha$ atoms (the central carbon atom in each amino acid). For structure models created with

tools in the workbench, this is based on an estimate of the local model quality. The color scale goes from blue (0) over white (50) to red (100). The b-factors as well as the local model quality estimate are measures of uncertainty or disorder in the atom position; the higher the number, the higher the uncertainty.

- Color by Entry. Each chain/molecule is assigned its own specific color.
- Custom Color. The user selects a molecule color from a palette.

Surfaces



Molecular surfaces can be visualized.

Five color schemes are available for surfaces:

- Color by Charge. Charged amino acids close to the surface will show as red (negative) or blue (positive) areas on the surface, with a color gradient that depends on the distance of the charged atom to the surface.
- Color by Element. Smoothed out coloring based on the classic CPK coloring of the heteroatoms close to the surface.
- Color by Temperature. Smoothed out coloring based on the temperature values assigned to atoms close to the surface (See the "Wireframe, Stick, Ball and stick, Space-filling/CPK" section above).
- Color by Entry. Each surface is assigned its own specific color.
- Custom Color. The user selects a surface color from a palette.

A surface spanning multiple molecules can be visualized by creating a custom atom group that includes all atoms from the molecules (see section [12.3.1](#))

It is possible to adjust the opacity of a surface by adjusting the transparency slider at the bottom of the menu.

Notice that visual artifacts may appear when rotating a transparent surface. These artifacts disappear as soon as the mouse is released.

Labels



Labels can be added to the molecules in the view by selecting an entry in the Project Tree and clicking the label button at the bottom of the Project Tree view. The color of the labels can be adjusted from the context menu by right clicking on the selected entry (which must be highlighted in blue first) or on the label button in the bottom of the Project Tree view (see figure [12.10](#)).

- For proteins and nucleic acids, each residue is labeled with the PDB name and number.
- For ligands, each atom is labeled with the atom name as given in the input.

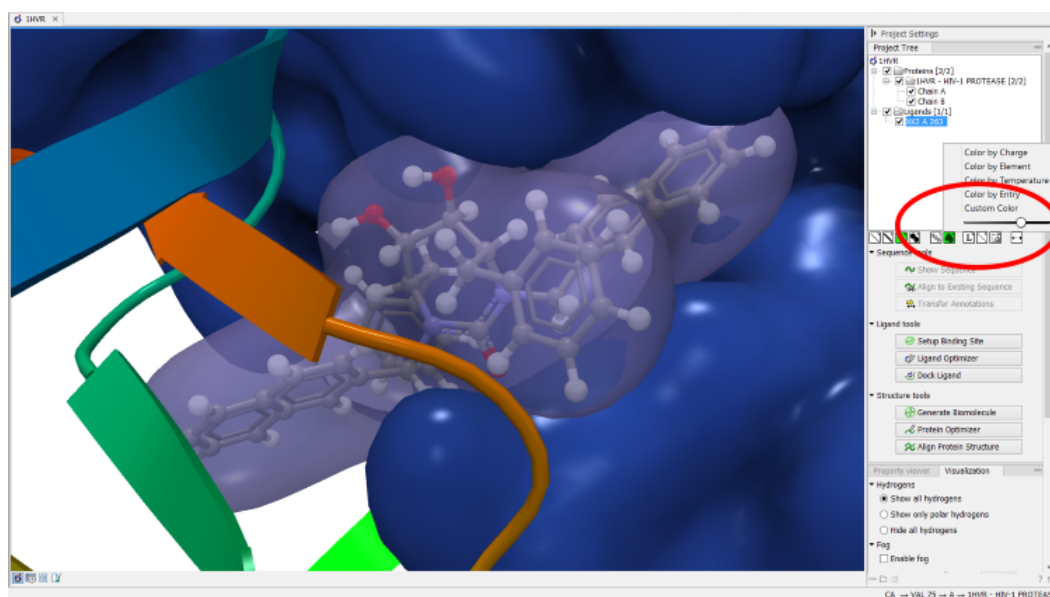

Figure 12.9: Transparent surfaces

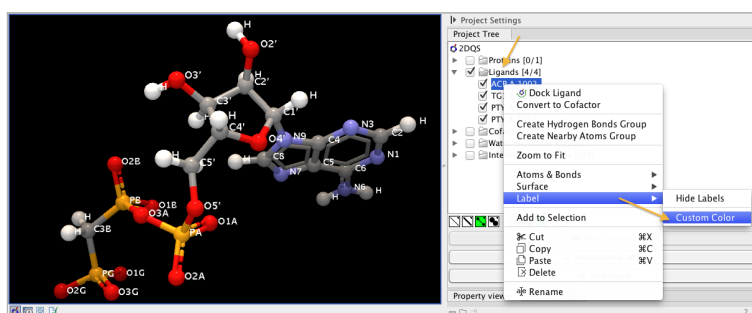

Figure 12.10: The color of the labels can be adjusted in two different ways. Either directly using the label button by right clicking the button, or by right clicking on the molecule or category of interest in the Project Tree.

- For cofactors and water, one label is added with the name of the molecule.
- For atom groups including protein atoms, each protein residue is labeled with the PDB name and number.
- For atom groups not including protein atoms, each atom is labeled with the atom name as given in the input.

Labels can be removed again by clicking on the label button.

Hydrogen bonds



The Show Hydrogen Bond visualization style may be applied to molecules and atom group entries in the project tree. If this style is enabled for a project tree entry, hydrogen bonds will be shown to all other currently visible objects. The hydrogen bonds are updated dynamically: if a molecule is toggled off, the hydrogen bonds to it will not be shown.

It is possible to customize the color of the hydrogen bonds using the context menu.

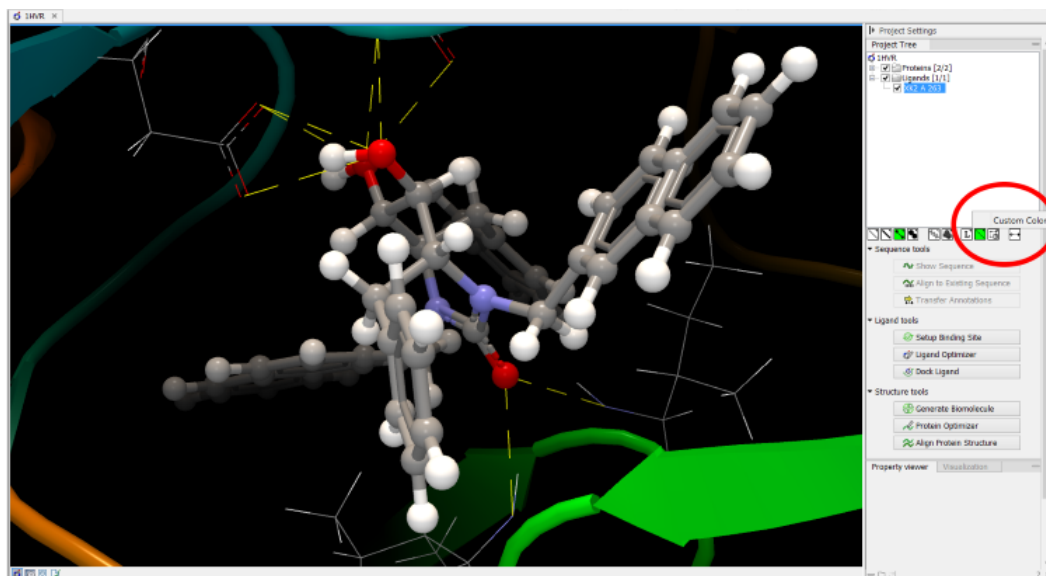

Figure 12.11: The hydrogen bond visualization setting, with custom bond color

Create atom group



Often it is convenient to use a unique visualization style or color to highlight a particular set of atoms, or to visualize only a subset of atoms from a molecule. This can be achieved by creating an atom group. Atom groups can be created based on atoms selected in the 3D view or entries selected in the Project Tree. When an atom group has been created, it appears as an entry in the Project Tree in the category "Atom groups". The atoms can then be hidden or shown, and the visualization changed, just as for the molecule entries in the Project Tree.

Note that an atom group entry can be renamed. Select the atom group in the Project Tree and invoke the right-click context menu. Here, the Rename option is found.

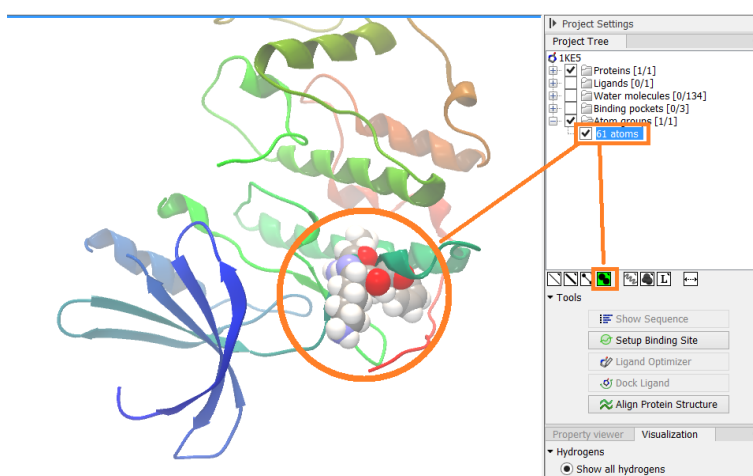

Figure 12.12: An atom group that has been highlighted by adding a unique visualization style.

Create atom group based on atoms selected in 3D view

When atoms are selected in the 3D view, brown spheres indicate which atoms are included in the selection. The selection will appear as the entry "Current" in the Selections category in the

Project Tree.

Once a selection has been made, press the "Create Atom Group" button and a context menu will show different options for creating a new atom group based on the selection:

- **Selected Atoms.** Creates an atom group containing exactly the selected atoms (those indicated by brown spheres). If an entire molecule or residue is selected, this option is not displayed.
- **Selected Residue(s)/Molecules.** Creates an atom group that includes all atoms in the selected residues (for entries in the protein and nucleic acid categories) and molecules (for the other categories).
- **Nearby Atoms.** Creates an atom group that contains residues (for the protein and nucleic acid categories) and molecules (for the other categories) within 5 Å of the selected atoms. Only atoms from currently visible Project Tree entries are considered.
- **Hydrogen Bonded Atoms.** Creates an atom group that contains residues (for the protein and nucleic acid categories) and molecules (for the other categories) that have hydrogen bonds to the selected atoms. Only atoms from currently visible Project Tree entries are considered.

There are several ways to select atoms in the 3D view:

- **Double click to select.** Click on an atom to select it. When you double click on an atom that belongs to a residue in a protein or in a nucleic acid chain, the entire residue will be selected. For small molecules, the entire molecule will be selected.
- **Adding atoms to a selection.** Holding down Ctrl while picking atoms, will pile up the atoms in the selection. All atoms in a molecule or category from the Project Tree, can be added to the "Current" selection by choosing "Add to Current Selection" in the context menu. Similarly, entire molecules can be removed from the current selection via the context menu.
- **Spherical selection.** Hold down the shift-key, click on an atom and drag the mouse away from the atom. Then a sphere centered on the atom will appear, and all atoms inside the sphere, visualized with one of the all-atom representations will be selected. The status bar (lower right corner) will show the radius of the sphere.
- **Show Sequence.** Another option is to select protein or nucleic acid entries in the Project Tree, and click the "Show Sequence" button found below the Project Tree (section 12.5.1). A split-view will appear with a sequence editor for each of the sequence data types (Protein, DNA, RNA) (figure 12.13). If you then select residues in the sequence view, the backbone atoms of the selected residues will show up as the "Current" selection in the 3D view and the Project Tree view. Notice that the link between the 3D view and the sequence editor is lost if either window is closed, or if the sequence is modified.
- **Align to Existing Sequence.** If a single protein chain is selected in the Project Tree, the "Align to Existing Sequence" button can be clicked (section 12.5.2). This links the protein sequence with a sequence or sequence alignment found in the Navigation Area. A split-view appears with a sequence alignment where the sequence of the selected protein chain is linked to the 3D structure, and atoms can be selected in the 3D view, just as for the "Show Sequence" option.

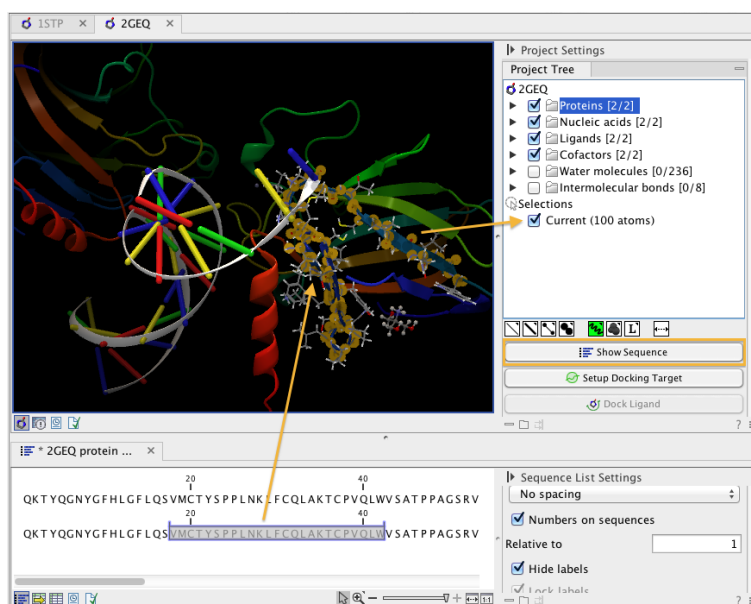

Figure 12.13: The protein sequence in the split view is linked with the protein structure. This means that when a part of the protein sequence is selected, the same region in the protein structure will be selected.

Create atom group based on entries selected in the Project Tree

Select one or more entries in the Project Tree, and press the "Create Atom Group" button, then a context menu will show different options for creating a new atom group based on the selected entries:

- **Nearby Atoms.** Creates an atom group that contains residues (for the protein and nucleic acid categories) and molecules (for the other categories) within 5 Å of the selected entries. Only atoms from currently visible Project Tree entries are considered. This option is also available on binding pocket entries (binding pockets can only be created in *CLC Drug Discovery Workbench*).
- **Hydrogen Bonded Atoms.** Creates an atom group that contains residues (for the protein and nucleic acid categories) and molecules (for the other categories) that have hydrogen bonds to the selected entries. Only atoms from currently visible Project Tree entries are considered.

If a Binding Site Setup is present in the Project Tree (A Binding Site Setup can only be created using *CLC Drug Discovery Workbench*), and entries from the Ligands or Docking results categories are selected, two extra options are available under the header **Create Atom Group (Binding Site)**. For these options, atom groups are created considering all molecules included in the Binding Site Setup, and thus not taking into account which Project Tree entries are currently visible.

Zoom to fit

(←→)

The "Zoom to fit" button can be used to automatically move a region of interest into the center of the screen. This can be done by selecting a molecule or category of interest in the Project Tree

view followed by a click on the "Zoom to fit" button (↔) at the bottom of the Project Tree view (figure 12.14). Double-clicking an entry in the Project Tree will have the same effect.

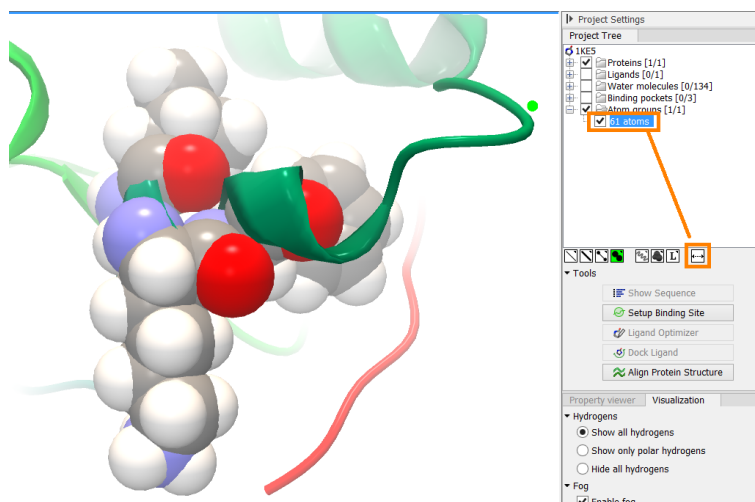

Figure 12.14: The "Fit to screen" button can be used to bring a particular molecule or category of molecules in focus.

12.3.2 Project settings

A number of general settings can be adjusted from the **Side Panel**. Personal settings as well as molecule visualizations can be saved by clicking in the lower right corner of the **Side Panel** (☰). This is described in detail in section 4.6.

Project Tree Tools

Just below the Project Tree, the following tools are available

- **Show Sequence** Select molecules which have sequences associated (Protein, DNA, RNA) in the Project Tree, and click this button. Then, a split-view will appear with a sequence editor for each of the sequence data types (Protein, DNA, RNA). This is described in section 12.5.1.
- **Align to Existing Sequence** Select a protein chain in the Project Tree, and click this button. Then protein sequences and sequence alignments found in the Navigation Area, can be linked with the protein structure. This is described in section 12.5.2.
- **Transfer Annotations** Select a protein chain in the Project Tree, that has been linked with a sequence using either the "Show Sequence" or "Align to Existing Sequence" options. Then it is possible to transfer annotations between the structure and the linked sequence. This is described in section 12.5.3.
- **Align Protein Structure** This will invoke the dialog for aligning protein structures based on global alignment of whole chains or local alignment of e.g. binding sites defined by atom groups. This is described in section 12.6.

Property viewer

The Property viewer, found in the Side Panel, lists detailed information about the atoms that the mouse hovers over. For all atoms the following information is listed:

- **Molecule** The name of the molecule the atom is part of.
- **Residue** For proteins and nucleic acids, the name and number of the residue the atom belongs to is listed, and the chain name is displayed in parentheses.
- **Name** The particular atom name, if given in input, with the element type (Carbon, Nitrogen, Oxygen...) displayed in parentheses.
- **Hybridization** The atom hybridization assigned to the atom.
- **Charge** The atomic charge as given in the input file. If charges are not given in the input file, some charged chemical groups are automatically recognized and a charge assigned.

For atoms in molecules imported from a PDB file, extra information is given:

- **Temperature** Here is listed the b-factor assigned to the atom in the PDB file. The b-factor is a measure of uncertainty or disorder in the atom position; the higher the number, the higher the disorder.
- **Occupancy** For each atom in a PDB file, the occupancy is given. It is typically 1, but if atoms are modeled in the PDB file, with no foundation in the raw data, the occupancy is 0. If a residue or molecule has been resolved in multiple positions, the occupancy is between 0 and 1.

For atoms in protein models created by tools in the workbench, the following extra information is given:

- **Temperature** For structure models, the temperature value is an estimate of local structure uncertainty. The three aspects contributing to the assigned atom temperature is also listed, and described in section [25.16.2](#). The temperature value is a measure of uncertainty or disorder in the atom position; the higher the number, the higher the disorder.
- **Occupancy** For modeled structures and atoms, the occupancy is set to zero.

If an atom is selected, the Property view will be frozen with the details of the selected atom shown. If then a second atom is selected (by holding down Ctrl while clicking), the distance between the two selected atoms is shown. If a third atom is selected, the angle for the second atom selected is shown. If a fourth atom is selected, the dihedral angle measured as the angle between the planes formed by the three first and three last selected atoms is given.

If a molecule is selected in the Project Tree, the Property view shows information about this molecule. Two measures are always shown:

- **Atoms** Number of atoms in the molecule.
- **Weight** The weight of the molecule in Daltons.

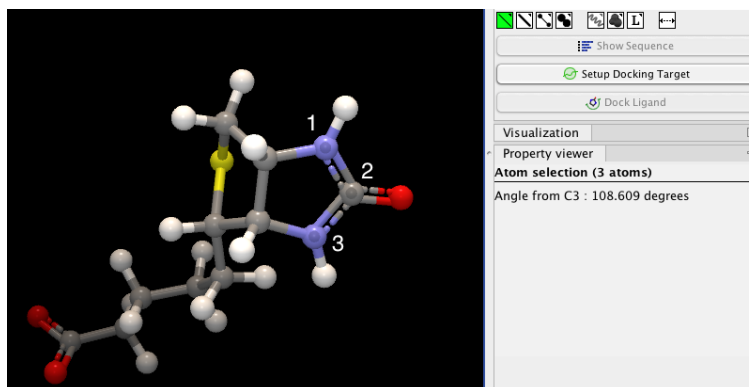



Figure 12.15: Selecting two, three, or four atoms will display the distance, angle, or dihedral angle, respectively.

Visualization settings

Under "Visualization" five options exist:

- **Hydrogens** Hydrogen atoms can be shown (Show all hydrogens), hidden (Hide all hydrogens) or partially shown (Show only polar hydrogens).
- **Fog** "Fog" is added to give a sense of depth in the view. The strength of the fog can be adjusted or it can be disabled.
- **Clipping plane** This option makes it possible to add an imaginary plane at a specified distance along the camera's line of sight. Only objects behind this plane will be drawn. It is possible to clip only surfaces, or to clip surfaces together with proteins and nucleic acids. Small molecules, like ligands and water molecules, are never clipped.
- **3D projection** The view is opened up towards the viewer, with a "Perspective" 3D projection. The field of view of the perspective can be adjusted, or the perspective can be disabled by selecting an orthographic 3D projection.
- **Coloring** The background color can be selected from a color palette by clicking on the colored box.

12.4 Snapshots of the molecule visualization

To save the current view as a picture, right-click in the **View Area** and select "File" and "Export Graphics". Another way to save an image is by pressing the "Graphics" button in the Workbench toolbar () . Next, select the location where you wish to save the image, select file format (PNG, JPEG, or TIFF), and provide a name, if you wish to use another name than the default name.

You can also save the current view directly on data with a custom name, so that it can later be applied (see section 4.6).

12.5 Tools for linking sequence and structure

The *CLC Genomics Workbench* has functionality that allows you to link a protein sequence to a protein structure. Selections made on the sequence will show up on the structure. This allows

you to explore a protein sequence in a 3D structure context. Furthermore, sequence annotations can be transferred to annotations on the structure and annotations on the structure can be transferred to annotations on the sequence (see section 12.5.3).

12.5.1 Show sequence associated with molecule

From the Side Panel, sequences associated with the molecules in the Molecule Project can be opened as separate objects by selecting protein or nucleic acid entries in the Project Tree and clicking the button labeled "Show Sequence" (figure 12.16). This will generate a Sequence or Sequence List for each selected sequence type (protein, DNA, RNA). The sequences can be used to select atoms in the Molecular Project as described in section 12.3.1. The sequences can also be used as input for sequence analysis tools or be saved as independent objects. You can later re-link to the sequence using "Align to Existing Sequence" (see section 12.5.2).

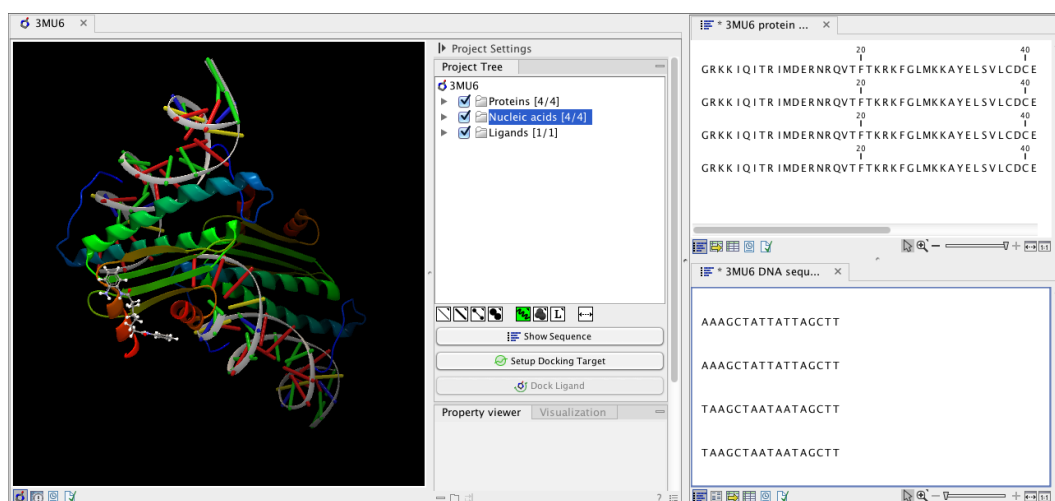

Figure 12.16: Protein chain sequences and DNA sequences are shown in separate views.

12.5.2 Link sequence or sequence alignment to structure

The "Align to Existing Sequence" button can be used to map and link existing sequences or sequence alignments to a protein structure chain in a Molecule Project (3D view). It can also be used to reconnect a protein structure chain to a sequence or sequence alignment previously created by Show Sequence (section 12.5.1) or Align to Existing Sequence.

Select a single protein chain in the project tree (see figure 12.17). Pressing "Align to Existing Sequence" then opens a Navigation Area browser, where it is possible to select one or more Sequence, Sequence Lists, or Alignments, to link with the selected protein chain.

If the sequences or alignments already contain a sequence identical to the protein chain selected in the Molecule Project (i.e. same name and amino acid sequence), this sequence is linked to the protein structure. If no identical sequence is present, a sequence is extracted from the protein structure (as for Show Sequence - section 12.5.1), and a sequence alignment is created between this sequence and the sequences or alignments selected from the Navigation Area. The new sequence alignment is created (see section 19.1) with the following settings:

- Gap open cost: 10.0

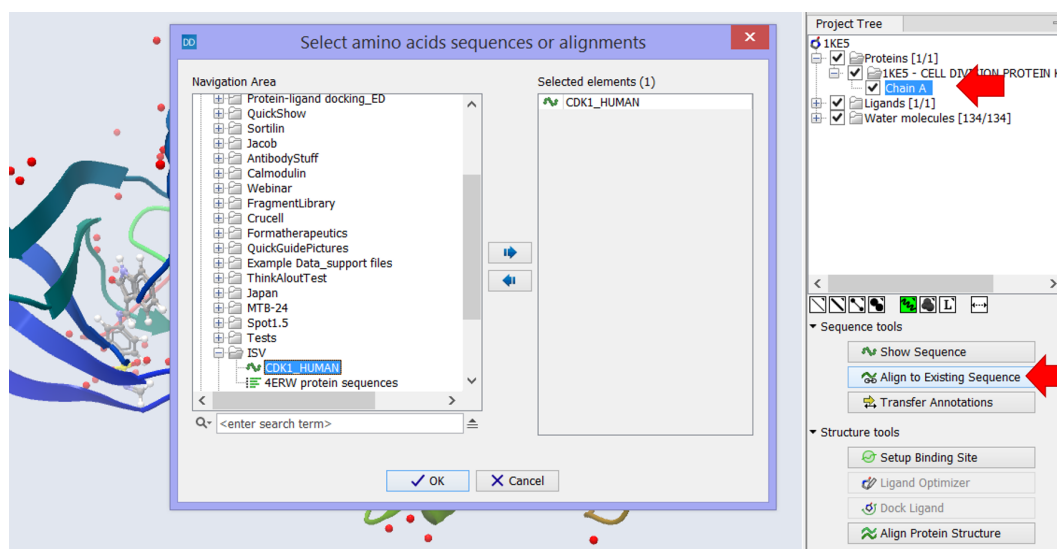

Figure 12.17: Select a single protein chain in the Project Tree and invoke "Align to Existing Sequence".

- Gap Extension cost: 1.0
- End gap cost: free
- Existing alignments are not redone

When the link is established, selections on the linked sequence in the sequence editor will create atom selections in the 3D view, and it is possible to transfer annotations between the linked sequence and the 3D protein chain (see section 12.5.3). Notice, that the link will be broken if either the sequence or the 3D protein chain is modified.

Two tips if the link is to a sequence in an alignment:

1. Read about how to change the layout of sequence alignments in section 19.2
2. It is only annotations present on the sequence linked to the 3D view that can be transferred to atom groups on the structure. To transfer sequence annotations from other sequences in the alignment, first copy the annotations to the sequence in the alignment that is linked to the structure (see figure 12.20 and section 19.3.4).

12.5.3 Transfer annotations between sequence and structure

The Transfer Annotations dialog makes it possible to create new atom groups (annotations on structure) based on protein sequence annotations and vice versa.

You can read more about sequence annotations in section 10.3 and more about atom groups in section 12.3.1.

Before it is possible to transfer annotations, a link between a protein sequence editor and a Molecule Project (a 3D view) must be established. This is done either by opening a sequence associated with a protein chain in the 3D view using the 'Show Sequence' button (see section 12.5.1) or by mapping to an existing sequence or sequence alignment using the 'Align to Existing Sequence' button (see section 12.5.2).

Invoke the Transfer Annotations dialog by selecting a linked protein chain in the Project Tree and press 'Transfer Annotations' (see figure 12.18).

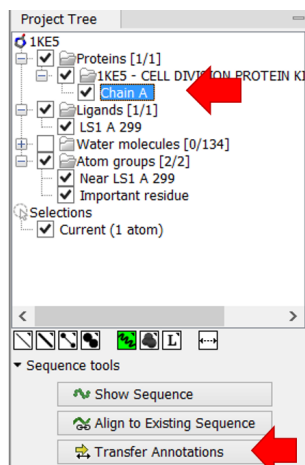

Figure 12.18: Select a single protein chain in the Project Tree and invoke "Transfer Annotations".

The dialog contains two tables (see figure 12.19). The left table shows all atom groups in the Molecule Project, with at least one atom on the selected protein chain. The right table shows all annotations present on the linked sequence. While the Transfer Annotations dialog is open, it is not possible to make changes to neither the sequence nor the Molecule Project, however, changes to the visualization styles are allowed.

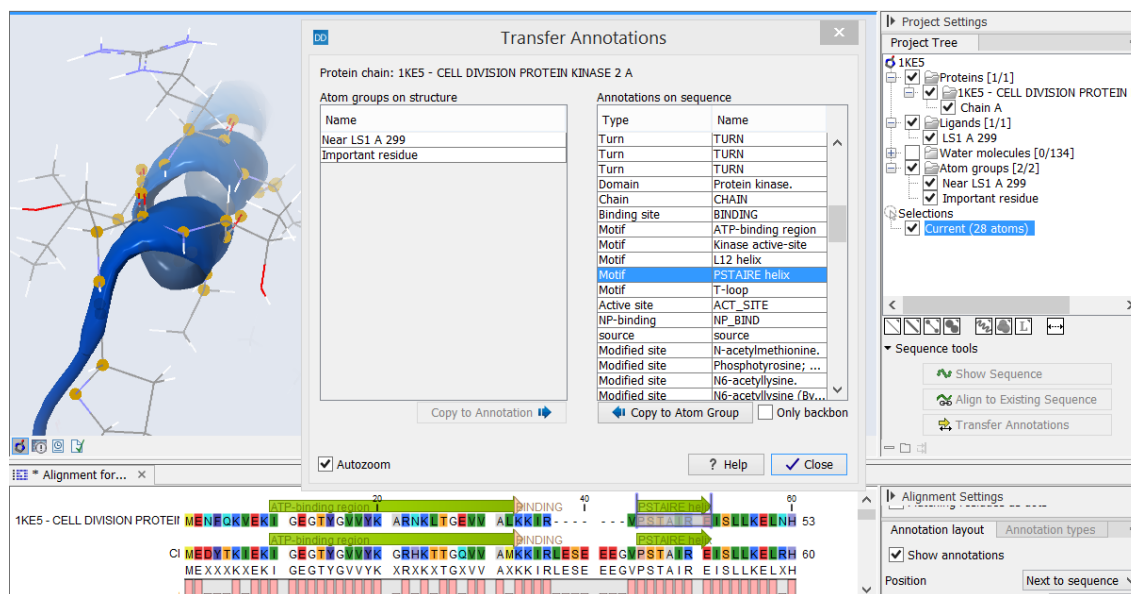

Figure 12.19: The Transfer Annotations dialog allow you to select annotations listed in the two tables, and copy them from structure to sequence or vice versa.

How to undo annotation transfers

In order to undo operations made using the Transfer Annotations dialog, the dialog must first be closed. To undo atom groups added to the structure, activate the 3D view by clicking in it and press Undo in the Toolbar. To undo annotations added to the sequence, activate the sequence view by clicking in it and press Undo in the Toolbar.

Transfer sequence annotations from aligned sequences

It is only annotations present on the sequence linked to the 3D view that can be transferred to atom groups on the structure. If you wish to transfer annotations that are found on other sequences in a linked sequence alignment, you need first to copy the sequence annotations to the actual sequence linked to the 3D view (the sequence with the same name as the protein structure). This is done by invoking the context menu on the sequence annotation you wish to copy (see figure 12.20 and section 19.3.4).

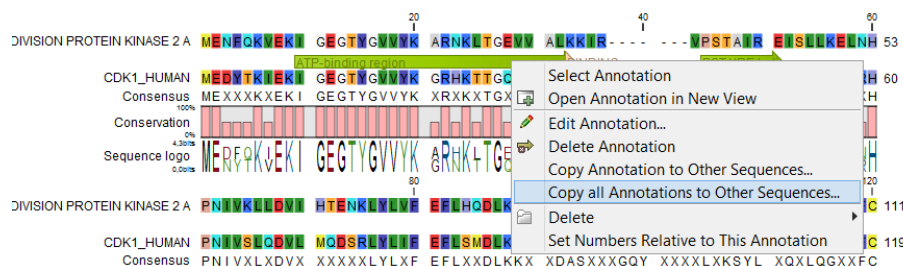



Figure 12.20: Copy annotations from sequences in the alignment to the sequence linked to the 3D view.

12.6 Protein structure alignment

The Align Protein Structure tool allows you to compare a protein or binding pocket in a **Molecule Project** with proteins from other **Molecule Projects**. The tool is invoked using the  Align Protein Structure action from the **Molecule Project Side Panel**. This action will open an interactive dialog box (figure 12.21). By default, when the dialog box is closed with an "OK", a new **Molecule Project** will be opened containing all the input protein structures laid on top of one another. All molecules coming from the same input Molecule Project will have the same color in the initial visualization.

12.6.1 The Align Protein Structure dialog box

The dialog box contains three fields:

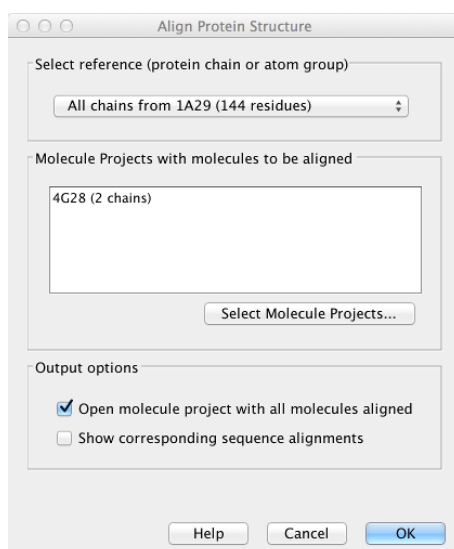

Figure 12.21: The Align Protein Structure dialog box.

- **Select reference (protein chain or atom group)** This drop-down menu shows all the protein chains and residue-containing atom groups in the current **Molecule Project**. If an atom group is selected, the structural alignment will be optimized in that area. The 'All chains from *Molecule Project* option will create a global alignment to all protein chains in the project, fitting e.g. a dimer to a dimer.
- **Molecule Projects with molecules to be aligned** One or more **Molecule Projects** containing protein chains may be selected.
- **Output options** The default output is a single **Molecule Project** containing all the input projects rotated onto the coordinate system of the reference. Several alignment statistics, including the RMSD, TM-score, and sequence identity, are added to the **History** of the output **Molecule Project**. Additionally, a sequence alignments of the aligned structures may be output, with the sequences linked to the 3D structure view.

12.6.2 Example: alignment of calmodulin

Calmodulin is a calcium binding protein. It is composed of two similar domains, each of which binds two calcium atoms. The protein is especially flexible, which can make structure alignment challenging. Here we will compare the calcium binding loops of two calmodulin crystal structures – PDB codes 1A29 and 4G28.

Initial global alignment The 1A29 project is opened and the Align Protein Structure dialog is filled out as in figure 12.21. Selecting "All chains from 1A29" tells the aligner to make the best possible global alignment, favoring no particular region. The output of the alignment is shown in figure 12.22. The blue chain is from 1A29, the brown chain is the corresponding calmodulin chain from 4G28 (a calmodulin-binding chain from the 4G28 file has been hidden from the view). Because calmodulin is so flexible, it is not possible to align both of its domains (enclosed in black boxes) at the same time. A good global alignment would require the brown protein to be translated in one direction to match the N-terminal domain, and in the other direction to match the C-terminal domain (see black arrows).

Focusing the alignment on the N-terminal domain To align only the N-terminal domain, we return to the 1A29 project and select the **Show Sequence** action from beneath the **Project Tree**. We highlight the first 62 residues, then convert them into an atom group by right-clicking on the "Current" selection in the **Project Tree** and choosing "Create Group from Selection" (figure 12.23). Using the new atom group as the reference in the alignment dialog leads to the alignment shown in figure 12.24. In addition to the original input proteins, the output now includes two Atom Groups, which contain the atoms on which the alignment was focused. The **History** of the output **Molecule Project** shows that the alignment has 0.9 Å RMSD over the 62 residues.

Aligning a binding site Two bound calcium atoms, one from each calmodulin structure, are shown in the black box of figure 12.24. We now wish to make an alignment that is as good as possible about these atoms so as to compare the binding modes. We return to the 1A29 project, right-click the calcium atom from the cofactors list in the **Project Tree** and select "Create Nearby Atoms Group". Using the new atom group as the reference in the alignment dialog leads to the alignment shown in figure 12.25.

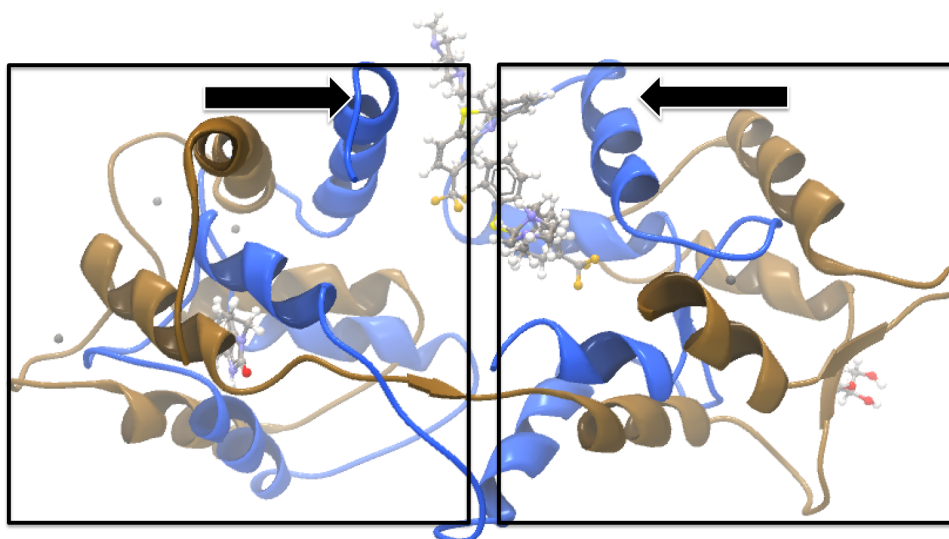

Figure 12.22: Global alignment of two calmodulin structures (blue and brown). The two domains of calmodulin (shown within black boxes) can undergo large changes in relative orientation. In this case, the different orientation of the domains in the blue and brown structures makes a good global alignment impossible: the movement required to align the brown structure onto the blue is shown by arrows – as the arrows point in opposite directions, improving the alignment of one domain comes at the cost of worsening the alignment of the other.

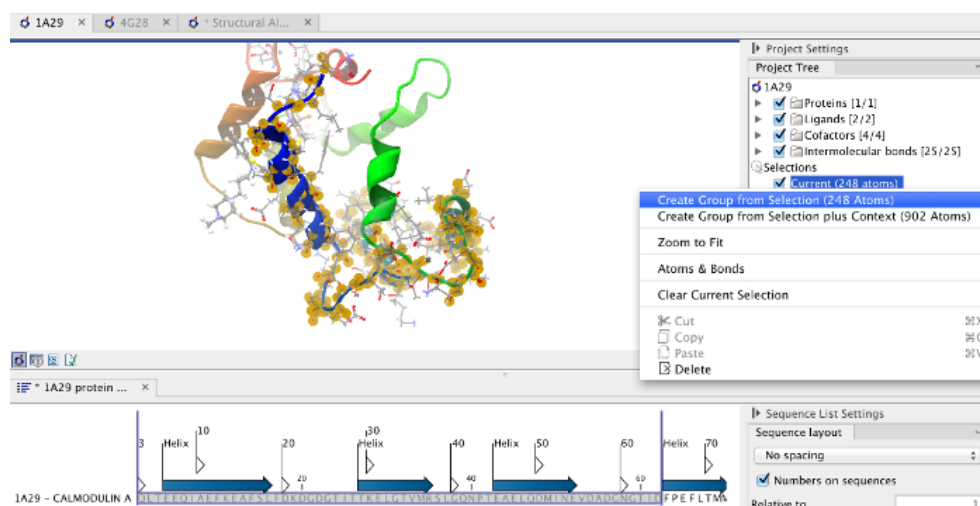

Figure 12.23: Creation of an atom group containing the N-terminal domain of calmodulin.

12.6.3 The Align Protein Structure algorithm

Any approach to structure alignment must make a trade-off between alignment length and alignment accuracy. For example, is it better to align 200 amino acids at an RMSD of 3.0 Å or 150 amino acids at an RMSD of 2.5 Å? The Align Protein Structure algorithm determines the answer to this question by taking the alignment with the higher TM-score. For an alignment focused on a protein of length L , this is:

$$\text{TM-score} = \frac{1}{L} \sum_i \frac{1}{1 + \frac{d_i}{d(L)}^2}$$

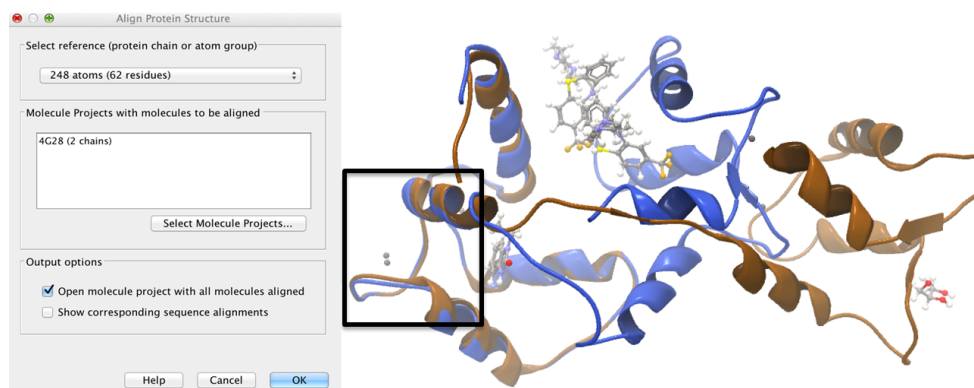

Figure 12.24: Alignment of the same two calmodulin proteins as in figure 12.22, but this time with a focus on the N-terminal domain. The blue and brown structures are now well-superimposed in the N-terminal region. The black box encloses two calcium atoms that are bound to the structures.

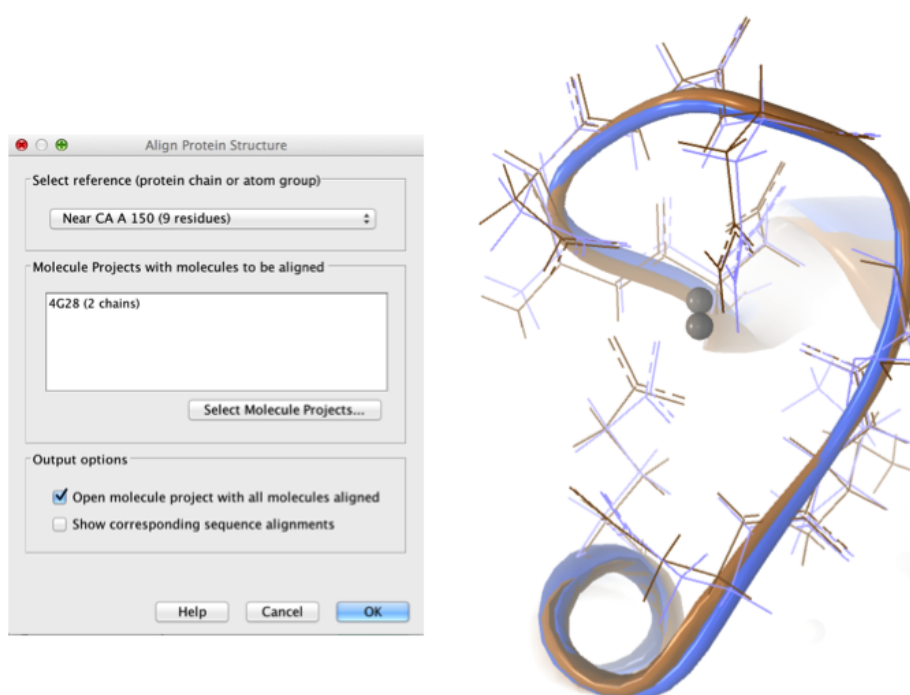

Figure 12.25: Alignment of the same two calmodulin domains as in figure 12.22, but this time with a focus on the calcium atom within the black box of figure 12.24. The calcium atoms are less than 1 Å apart – compatible with thermal motion encoded in the atoms' temperature factors.

where i runs over the aligned pairs of residues, d_i is the distance between the i^{th} such pair, and $d(L)$ is a normalization term that approximates the average distance between two randomly chosen points in a globular protein of length L [Zhang and Skolnick, 2004]. A perfect alignment has a TM-score of 1.0, and two proteins with a TM-score >0.5 are often said to show structural homology [Xu and Zhang, 2010].

The Align Protein Structure Algorithm attempts to find the *structure alignment* with the highest TM-score. This problem reduces to finding a *sequence alignment* that pairs residues in a way that results in a high TM-score. Several sequence alignments are tried including an alignment with the BLOSUM62 matrix, an alignment of secondary structure elements, and iterative refinements

of these alignments.

The Align Protein Structure Algorithm is also capable of aligning entire protein complexes. To do this, it must determine the correct pairing of each chain in one complex with a chain in the other. This set of chain pairings is determined by the following procedure:

1. Make structure alignments between every chain in one complex and every chain in the other. Discard pairs of chains that have a TM-score of < 0.4
2. Find all pairs of structure alignments that are consistent with each other i.e. are achieved by approximately the same rotation
3. Use a heuristic to combine consistent pairs of structure alignments into a single alignment

The heuristic used in the last step is similar to that of MM-align [Mukherjee and Zhang, 2009], whereas the first two steps lead to both a considerable speed up and increased accuracy. The alignment of two 30S ribosome subunits, each with 20 protein chains, can be achieved in less than a minute (PDB codes 2QBD and 1FJG).

Chapter 13

General sequence analyses

Contents

13.1 Extract Annotations	308
13.2 Extract sequences	310
13.3 Shuffle sequence	312
13.4 Dot plots	314
13.4.1 Create dot plots	314
13.4.2 View dot plots	316
13.4.3 Bioinformatics explained: Dot plots	316
13.4.4 Bioinformatics explained: Scoring matrices	319
13.5 Local complexity plot	323
13.6 Sequence statistics	324
13.6.1 Bioinformatics explained: Protein statistics	328
13.7 Join sequences	331
13.8 Pattern discovery	332
13.8.1 Pattern discovery search parameters	333
13.8.2 Pattern search output	333
13.9 Motif Search	334
13.9.1 Dynamic motifs	334
13.9.2 Motif search from the Toolbox	335
13.9.3 Java regular expressions	338
13.10 Create motif list	339

CLC Genomics Workbench offers different kinds of sequence analyses that apply to both protein and DNA. The analyses are described in this chapter.

13.1 Extract Annotations

The **Extract annotations** tool makes it very easy to extract parts of a sequence (or several sequences) based on its annotations. In just a few steps, it becomes possible to:

- extract all tRNA genes from a genome.

- automatically add flanking regions to the annotated sequences.
- search for specific words in all available annotations.
- extract nucleotide sequences of differentially expressed genes or transcripts when using RNA-seq statistical comparisons as input.

The output is a sequence list that contains sequences carrying the annotation specified (including the flanking regions, if this option was selected).

To extract annotations from a sequence, go to:

Toolbox | Classical Sequence Analysis (📁) | **General Sequence Analysis** (📁) | **Extract Annotations** (👉)

This opens the dialog shown in figure 13.1 where you can select one or more annotated sequences, or annotation tracks, or variant tracks, or statistical comparisons. Click **Next**.

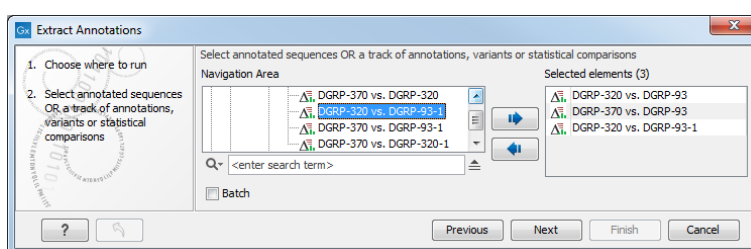

Figure 13.1: Select one or more annotated sequences, annotations, variant tracks or (in this figure) statistical comparisons.

If you selected tracks as input, the next step will ask for a reference sequence track to use for extracting the annotations, or which annotations to use if an annotated sequence was selected as input (figure 13.2).

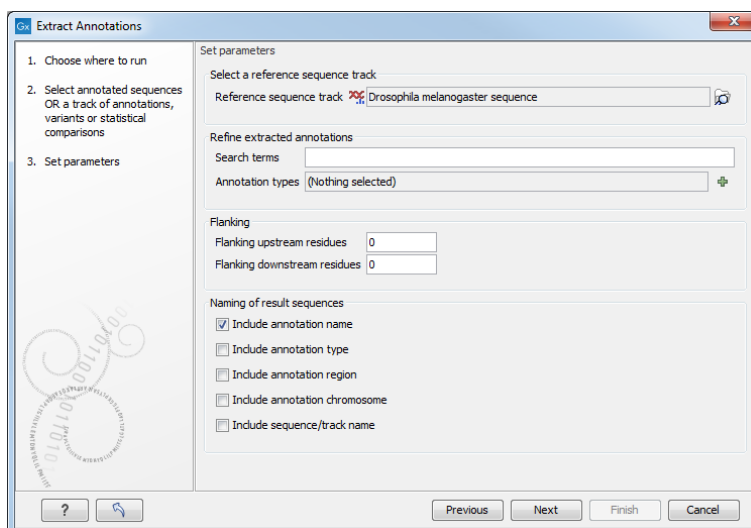

Figure 13.2: Adjusting parameters for extract annotations.

- **Search terms.** All annotations and attached information for each annotation will be searched for the entered term. It can be used to make general searches for search terms such as "Gene" or "Exon", or it can be used to make more specific searches. For example,

if you have a gene annotation called "MLH1" and another called "MLH3", you can extract both annotations by entering "MLH" in the search term field. If you wish to enter more specific search terms, separate them with commas: "MLH1, Human" will find annotations including both "MLH1" and "Human".

- **Annotation types** If only certain types of annotations should be extracted, this can be specified here.

The sequence of interest can be extracted with flanking sequences:

- **Flanking upstream residues.** The output will include this number of extra residues at the 5' end of the annotation.
- **Flanking downstream residues.** The output will include this number of extra residues at the 3' end of the annotation.

The sequences that are created can be named after the annotation name, type etc:



- **Include annotation name.** This will use the name of the annotation in the name of the extracted sequence.
- **Include annotation type.** This corresponds to the type chosen above and will put this information in the name of the resulting sequences. This is useful information if you have chosen to extract "All" types of annotations.
- **Include annotation region.** The region covered by the annotation on the original sequence (i.e. not including flanking regions) will be included in the name.
- **Include sequence/track name.** If you have selected more than one sequence as input, this option enables you to discern the origin of the resulting sequences in the list by putting the name of the original sequence into the name of the resulting sequences.

Click **Next** if you wish to adjust how to handle the results (see section 8.2). If not, click **Finish**.

13.2 Extract sequences

This tool allows the extraction of sequences from other types of data in the Workbench, such as sequence lists or alignments. The data types you can extract sequences from are:

- Alignments ()
- BLAST result ()
- BLAST overview tables ()
- sequence lists ()
- Contigs and read mappings ()
- Read mapping tables ()

- Read mapping tracks 
- RNA-Seq mapping results 

Note! When the Extract Sequences tool is run via the Workbench toolbox on an entire file of one of the above types, **all** sequences are extracted from the data used as input. If only a **subset** of the sequences is desired, for example, the reads from just a small area of a mapping, or the sequences for only a few blast results, then a data set containing just this subsection or subset should be created and the Extract Sequences tool should be run on that.

For extracting a subset of a mapping, please see section 17.7.6 that describes the function "Extract from Selection" that also can be selected from the right click menu (see figure 13.3).

For extracting a subset of a sequence list, you can highlight the sequences of interest in the table view of the sequence list, right click on the selection and launch the Extract Sequences tool.

The Extract Sequences tool can be launched via the Toolbox menu, by going to:

**Toolbox | Classical Sequence Analysis  | General Sequence Analysis  |
Extract Sequences **

Alternatively, on all the data types listed above except sequence lists, the option to run this tool appears by right clicking in the relevant area; a row in a table or in the read area of mapping data. An example is shown in figure 13.3.

Please note that for mappings, only the read sequences are extracted. Reference and consensus sequences are not extracted using this tool. Similarly, when extracting sequences from BLAST results, the sequence hits are extracted, not the original query sequence or a consensus sequence.

"Note also, that paired reads will be extracted in accordance with the read group settings, which is specified during the original import of the reads. If the orientation has since been changed (e.g. using the Element Info tab for the sequence list) the read group information will be modified and reads will be extracted as specified by the modified read group. The default read group orientation is forward-reverse."

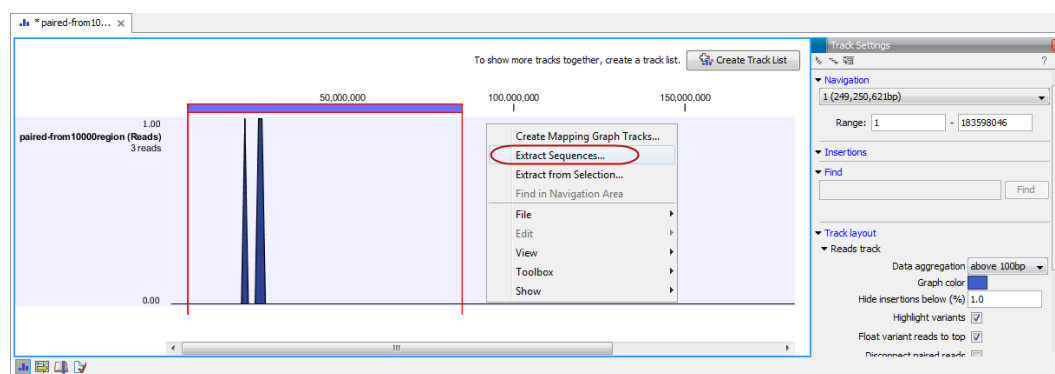

Figure 13.3: Right click somewhere in the reads track area and select "Extract Sequences".

The dialog allows you to select the **Destination**. Here you can choose whether the extracted sequences should be extracted as single sequences or placed in a new sequence list. For most data types, it will make most sense to choose to extract the sequences into a sequence list. The exception to this is when working with a sequence list, where choosing to extract to a sequence

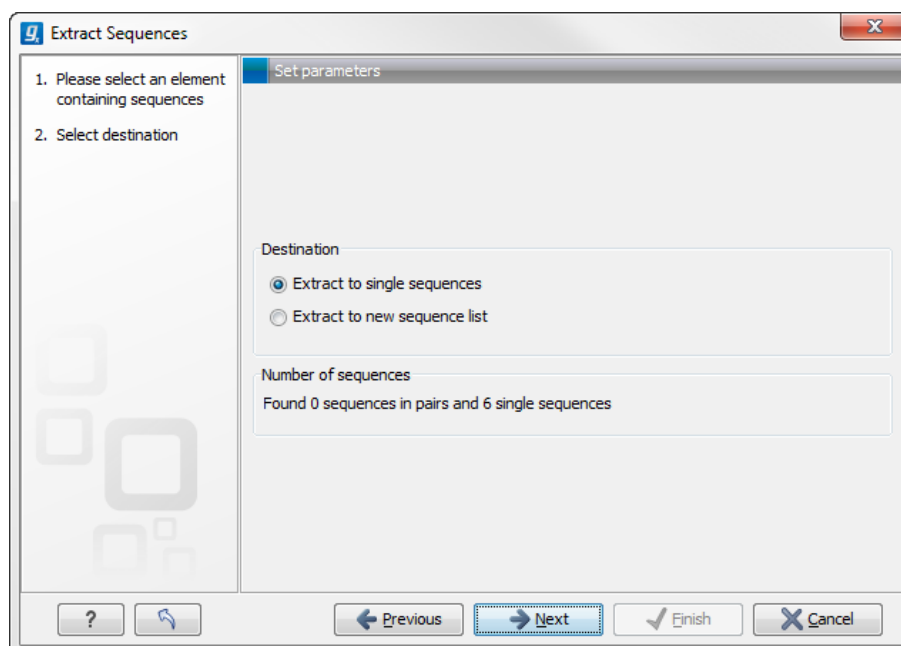

Figure 13.4: Choosing whether the extracted sequences should be placed in a new list or as single sequences.

list would create a copy of the same sequence list. In this case, the other option would generally be chosen. This would then result in the generation of individual sequence objects for each sequence in the sequence list.

Below these options, in the dialog, you can see the number of sequences that will be extracted.

13.3 Shuffle sequence

In some cases, it is beneficial to shuffle a sequence. This is an option in the **Toolbox** menu under **General Sequence Analyses**. It is normally used for statistical analyses, e.g. when comparing an alignment score with the distribution of scores of shuffled sequences.

Shuffling a sequence removes all annotations that relate to the residues. To launch the tool, go to:

Toolbox | **Classical Sequence Analysis** (📁) | **General Sequence Analysis** (📁) | **Shuffle Sequence** (🔍)

This opens the dialog displayed in figure 13.5:

If a sequence was selected before choosing the Toolbox action, this sequence is now listed in the **Selected Elements** window of the dialog. Use the arrows to add or remove sequences or sequence lists, from the selected elements.

Click **Next** to determine how the shuffling should be performed.

In this step, shown in figure 13.6:

For nucleotides, the following parameters can be set:

- **Mononucleotide shuffling.** Shuffle method generating a sequence of the exact same

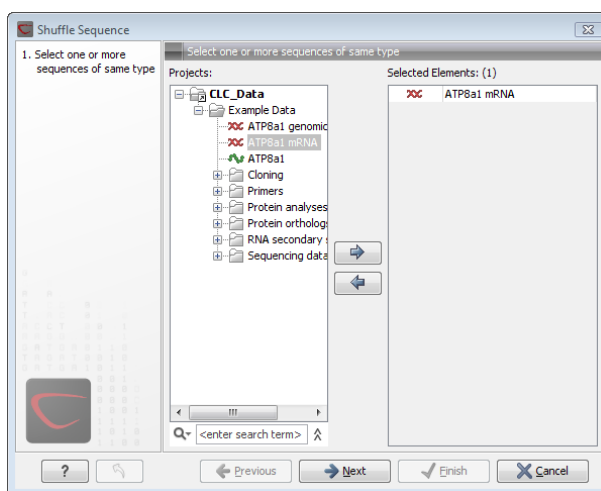

Figure 13.5: Choosing sequence for shuffling.

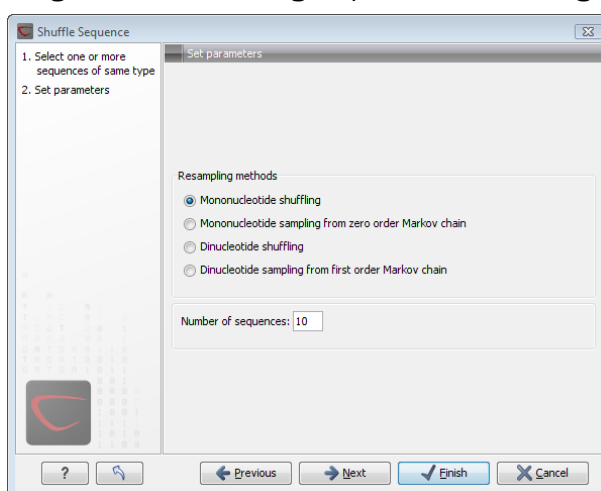

Figure 13.6: Parameters for shuffling.

mononucleotide frequency

- **Dinucleotide shuffling.** Shuffle method generating a sequence of the exact same dinucleotide frequency
- **Mononucleotide sampling from zero order Markov chain.** Resampling method generating a sequence of the same expected mononucleotide frequency.
- **Dinucleotide sampling from first order Markov chain.** Resampling method generating a sequence of the same expected dinucleotide frequency.

For proteins, the following parameters can be set:

- **Single amino acid shuffling.** Shuffle method generating a sequence of the exact same amino acid frequency.
- **Single amino acid sampling from zero order Markov chain.** Resampling method generating a sequence of the same expected single amino acid frequency.
- **Dipeptide shuffling.** Shuffle method generating a sequence of the exact same dipeptide frequency.

- **Dipeptide sampling from first order Markov chain.** Resampling method generating a sequence of the same expected dipeptide frequency.

For further details of these algorithms, see [Clote et al., 2005]. In addition to the shuffle method, you can specify the number of randomized sequences to output.

Click **Next** if you wish to adjust how to handle the results (see section 8.2). If not, click **Finish**.

This will open a new view in the **View Area** displaying the shuffled sequence. The new sequence is not saved automatically. To save the sequence, drag it into the **Navigation Area** or press ctrl + S (⌘ + S on Mac) to activate a save dialog.

13.4 Dot plots

Dot plots provide a powerful visual comparison of two sequences. Dot plots can also be used to compare regions of similarity within a sequence. This chapter first describes how to create and second how to

This section describes how to adjust the view of the plot.

13.4.1 Create dot plots

A dot plot is a simple, yet intuitive way of comparing two sequences, either DNA or protein, and is probably the oldest way of comparing two sequences [Maizel and Lenk, 1981]. A dot plot is a 2 dimensional matrix where each axis of the plot represents one sequence. By sliding a fixed size window over the sequences and making a sequence match by a dot in the matrix, a diagonal line will emerge if two identical (or very homologous) sequences are plotted against each other. Dot plots can also be used to visually inspect sequences for direct or inverted repeats or regions with low sequence complexity. Various smoothing algorithms can be applied to the dot plot calculation to avoid noisy background of the plot. Moreover, various substitution matrices can be applied in order to take the evolutionary distance of the two sequences into account.

To create a dot plot, go to:

Toolbox | **Classical Sequence Analysis** (🗂️) | **General Sequence Analysis** (🗂️)|
Create Dot Plot (📄)

This opens the dialog shown in figure 13.7.

If a sequence was selected before choosing the **Toolbox** action, this sequence is now listed in the **Selected Elements** window of the dialog. Use the arrows to add or remove elements from the selected elements. Click **Next** to adjust dot plot parameters. Clicking **Next** opens the dialog shown in figure 13.8.

Note! Calculating dot plots takes up a considerable amount of memory in the computer. Therefore, you will see a warning message if the sum of the number of nucleotides/amino acids in the sequences is higher than 8000. If you insist on calculating a dot plot with more residues the Workbench may shut down, but still allowing you to save your work first. However, this depends on your computer's memory configuration.

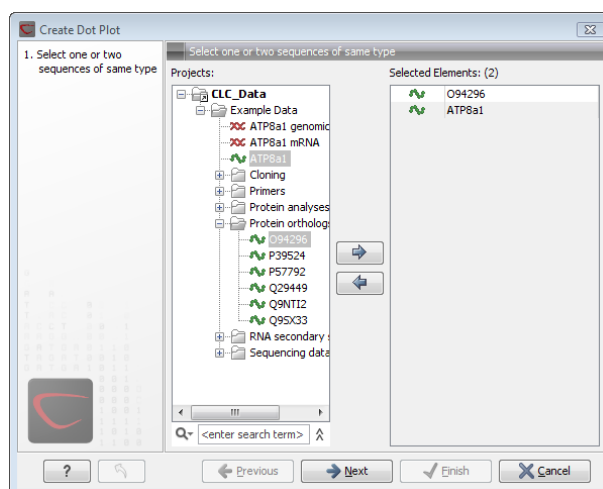

Figure 13.7: Selecting sequences for the dot plot.

Adjust dot plot parameters

There are two parameters for calculating the dot plot:

- **Distance correction (only valid for protein sequences)** In order to treat evolutionary transitions of amino acids, a distance correction measure can be used when calculating the dot plot. These distance correction matrices (substitution matrices) take into account the likeliness of one amino acid changing to another.
- **Window size** A residue by residue comparison (window size = 1) would undoubtedly result in a very noisy background due to a lot of similarities between the two sequences of interest. For DNA sequences the background noise will be even more dominant as a match between only four nucleotide is very likely to happen. Moreover, a residue by residue comparison (window size = 1) can be very time consuming and computationally demanding. Increasing the window size will make the dot plot more 'smooth'.

Click **Next** if you wish to adjust how to handle the results (see section 8.2). If not, click **Finish**.

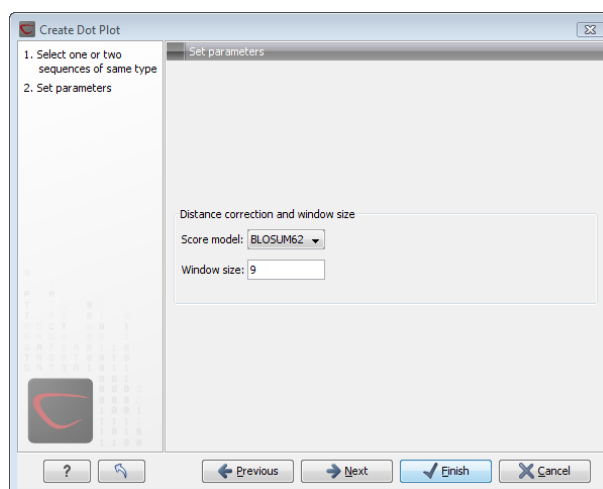

Figure 13.8: Setting the dot plot parameters.

13.4.2 View dot plots

A view of a dot plot can be seen in figure 13.9. You can select **Zoom in** (🔍) in the Toolbar and click the dot plot to zoom in to see the details of particular areas.

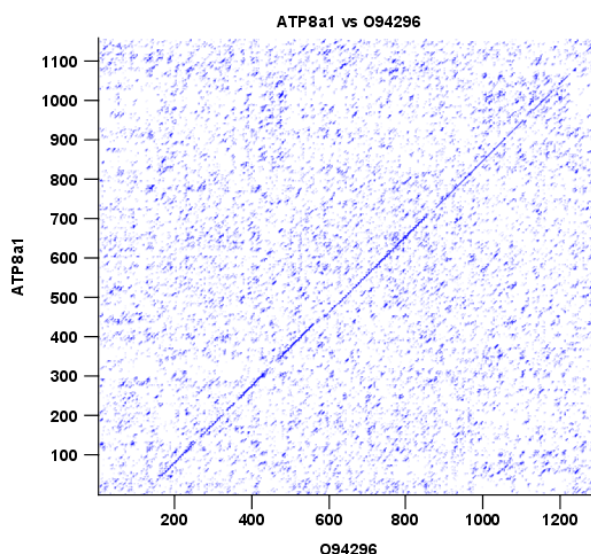

Figure 13.9: A view is opened showing the dot plot.

The **Side Panel** to the right let you specify the dot plot preferences. The gradient color box can be adjusted to get the appropriate result by dragging the small pointers at the top of the box. Moving the slider from the right to the left lowers the thresholds which can be directly seen in the dot plot, where more diagonal lines will emerge. You can also choose another color gradient by clicking on the gradient box and choose from the list.

Adjusting the sliders above the gradient box is also practical, when producing an output for printing. (Too much background color might not be desirable). By crossing one slider over the other (the two sliders change side) the colors are inverted, allowing for a white background. (If you choose a color gradient, which includes white). See figure 13.9.

13.4.3 Bioinformatics explained: Dot plots

Realization of dot plots

Dot plots are two-dimensional plots where the x-axis and y-axis each represents a sequence and the plot itself shows a comparison of these two sequences by a calculated score for each position of the sequence. If a window of fixed size on one sequence (one axis) match to the other sequence a dot is drawn at the plot. Dot plots are one of the oldest methods for comparing two sequences [Maizel and Lenk, 1981].

The scores that are drawn on the plot are affected by several issues.

- Scoring matrix for distance correction.
Scoring matrices (BLOSUM and PAM) contain substitution scores for every combination of two amino acids. Thus, these matrices can only be used for dot plots of protein sequences.
- Window size

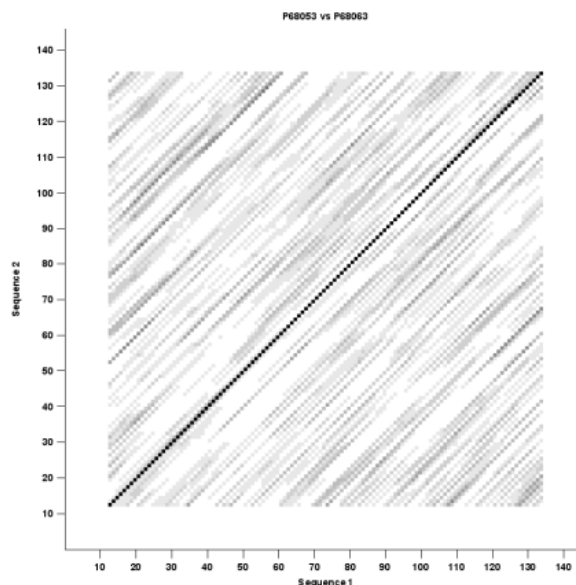

Figure 13.10: Dot plot with inverted colors, practical for printing.

The single residue comparison (bit by bit comparison (window size = 1)) in dot plots will undoubtedly result in a noisy background of the plot. You can imagine that there are many successes in the comparison if you only have four possible residues like in nucleotide sequences. Therefore you can set a window size which is smoothing the dot plot. Instead of comparing single residues it compares subsequences of length set as window size. The score is now calculated with respect to aligning the subsequences.

- Threshold

The dot plot shows the calculated scores with colored threshold. Hence you can better recognize the most important similarities.

Examples and interpretations of dot plots

Contrary to simple sequence alignments dot plots can be a very useful tool for spotting various evolutionary events which may have happened to the sequences of interest.

Below is shown some examples of dot plots where sequence insertions, low complexity regions, inverted repeats etc. can be identified visually.

Similar sequences

The most simple example of a dot plot is obtained by plotting two homologous sequences of interest. If very similar or identical sequences are plotted against each other a diagonal line will occur.

The dot plot in figure 13.11 shows two related sequences of the Influenza A virus nucleoproteins infecting ducks and chickens. Accession numbers from the two sequences are: DQ232610 and DQ023146. Both sequences can be retrieved directly from <http://www.ncbi.nlm.nih.gov/gquery/gquery.fcgi>.

Repeated regions

Sequence repeats can also be identified using dot plots. A repeat region will typically show up as

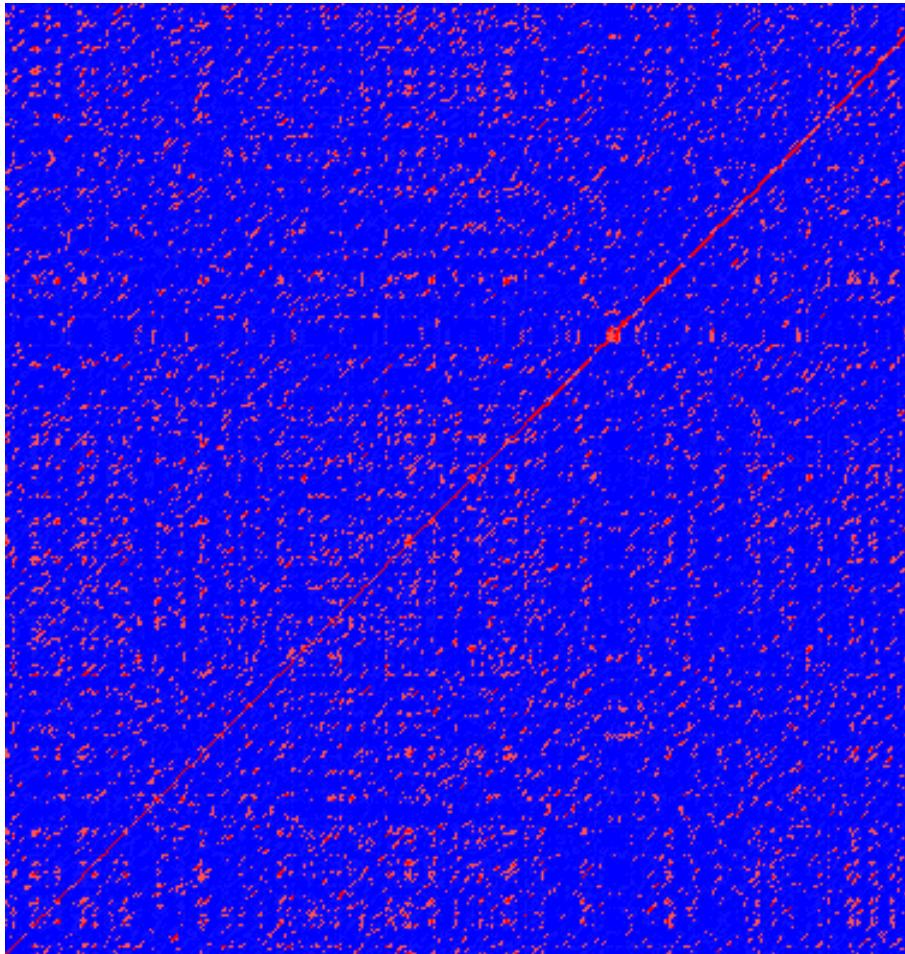

Figure 13.11: Dot plot of DQ232610 vs. DQ023146 (Influenza A virus nucleoproteins) showing and overall similarity

lines parallel to the diagonal line.

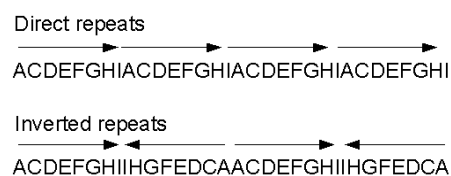

Figure 13.12: Direct and inverted repeats shown on an amino acid sequence generated for demonstration purposes.

If the dot plot shows more than one diagonal in the same region of a sequence, the regions depending to the other sequence are repeated. In figure 13.13 you can see a sequence with repeats.

Frame shifts

Frame shifts in a nucleotide sequence can occur due to insertions, deletions or mutations. Such frame shifts can be visualized in a dot plot as seen in figure 13.14. In this figure, three frame shifts for the sequence on the y-axis are found.

1. Deletion of nucleotides

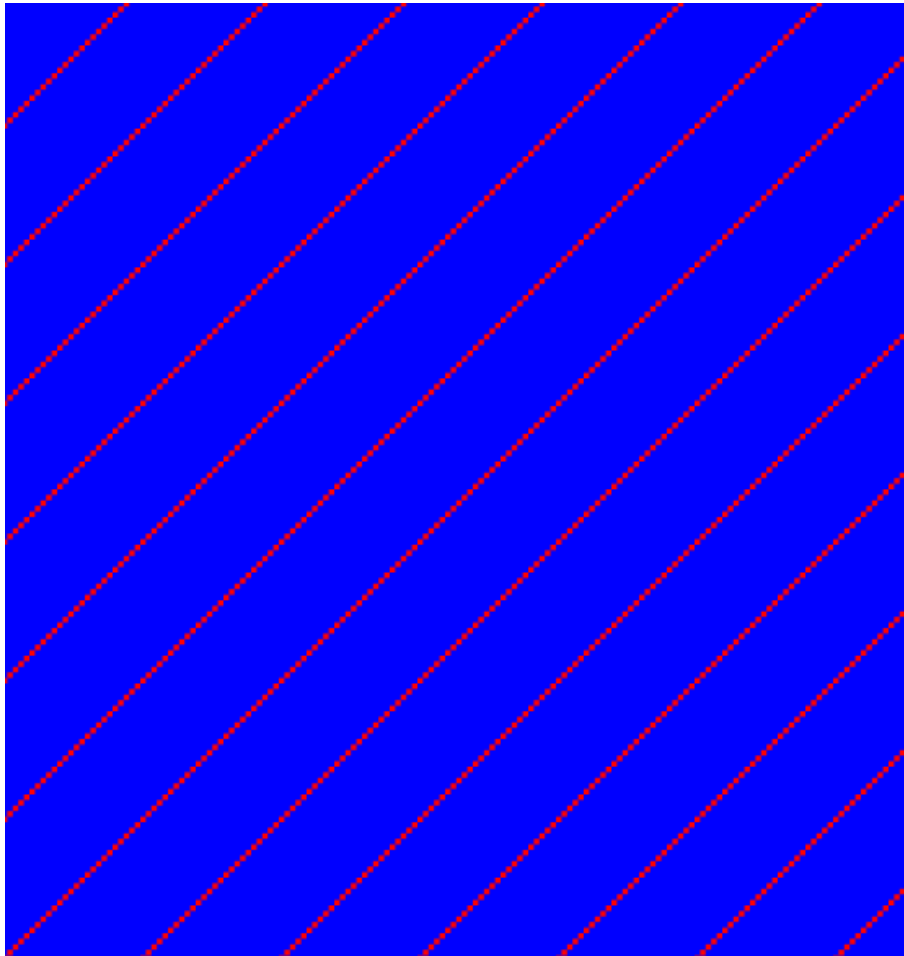

Figure 13.13: The dot plot of a sequence showing repeated elements. See also figure 13.12.

2. Insertion of nucleotides
3. Mutation (out of frame)

Sequence inversions

In dot plots you can see an inversion of sequence as contrary diagonal to the diagonal showing similarity. In figure 13.15 you can see a dot plot (window length is 3) with an inversion.

Low-complexity regions

Low-complexity regions in sequences can be found as regions around the diagonal all obtaining a high score. Low complexity regions are calculated from the redundancy of amino acids within a limited region [Wootton and Federhen, 1993]. These are most often seen as short regions of only a few different amino acids. In the middle of figure 13.16 is a square shows the low-complexity region of this sequence.

13.4.4 Bioinformatics explained: Scoring matrices

Biological sequences have evolved throughout time and evolution has shown that not all changes to a biological sequence is equally likely to happen. Certain amino acid substitutions (change of one amino acid to another) happen often, whereas other substitutions are very rare. For instance,

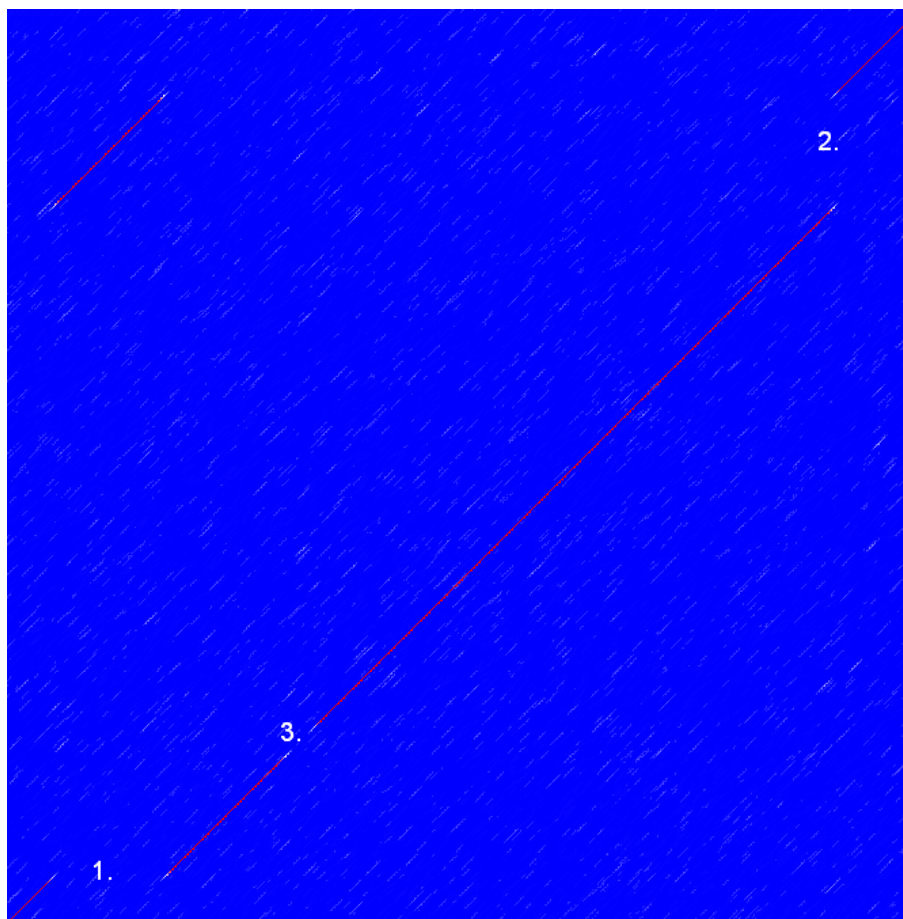

Figure 13.14: This dot plot show various frame shifts in the sequence. See text for details.

tryptophan (W) which is a relatively rare amino acid, will only – on very rare occasions – mutate into a leucine (L).

Based on evolution of proteins it became apparent that these changes or substitutions of amino acids can be modeled by a scoring matrix also referred to as a substitution matrix. See an example of a scoring matrix in table 13.1. This matrix lists the substitution scores of every single amino acid. A score for an aligned amino acid pair is found at the intersection of the corresponding column and row. For example, the substitution score from an arginine (R) to a lysine (K) is 2. The diagonal show scores for amino acids which have not changed. Most substitutions changes have a negative score. Only rounded numbers are found in this matrix.

The two most used matrices are the BLOSUM [Henikoff and Henikoff, 1992] and PAM [Dayhoff and Schwartz, 1978].

Different scoring matrices

PAM

The first PAM matrix (Point Accepted Mutation) was published in 1978 by Dayhoff et al. The PAM matrix was build through a global alignment of related sequences all having sequence similarity above 85% [Dayhoff and Schwartz, 1978]. A PAM matrix shows the probability that any given amino acid will mutate into another in a given time interval. As an example, PAM1 gives that one amino acid out of a 100 will mutate in a given time interval. In the other end of the scale, a

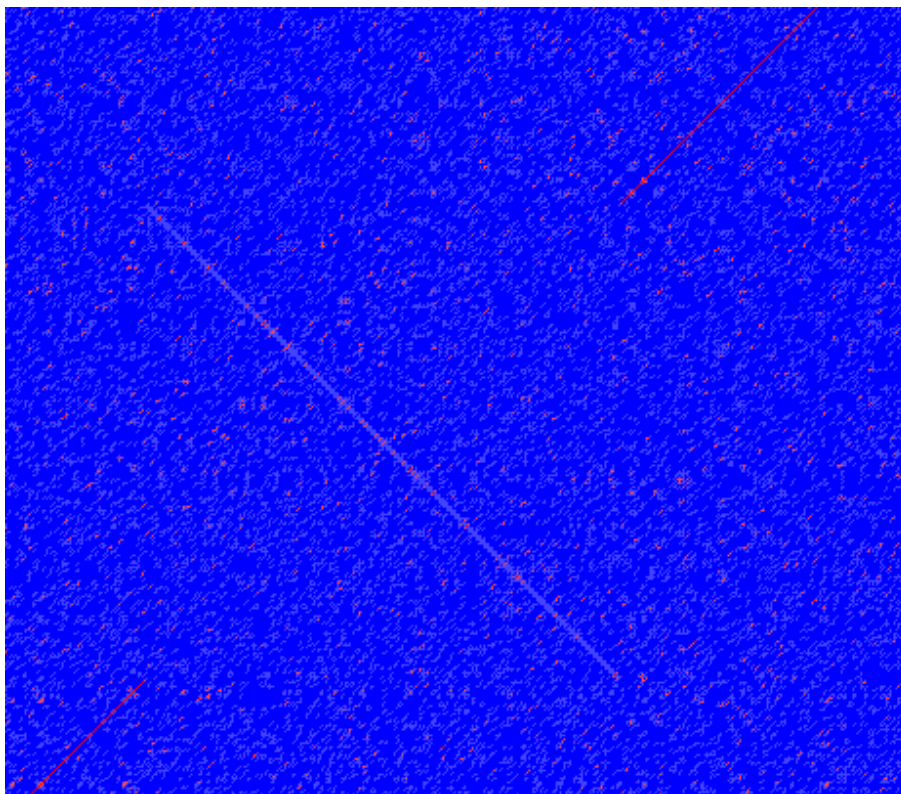

Figure 13.15: The dot plot showing an inversion in a sequence. See also figure 13.12.

PAM256 matrix, gives the probability of 256 mutations in a 100 amino acids (see figure 13.17).

There are some limitation to the PAM matrices which makes the BLOSUM matrices somewhat more attractive. The dataset on which the initial PAM matrices were build is very old by now, and the PAM matrices assume that all amino acids mutate at the same rate - this is not a correct assumption.

BLOSUM

In 1992, 14 years after the PAM matrices were published, the BLOSUM matrices (BLOcks SUbstitution Matrix) were developed and published [Henikoff and Henikoff, 1992].

Henikoff et al. wanted to model more divergent proteins, thus they used locally aligned sequences where none of the aligned sequences share less than 62% identity. This resulted in a scoring matrix $\frac{1}{2}$ called BLOSUM62. In contrast to the PAM matrices the BLOSUM matrices are calculated from alignments without gaps emerging from the BLOCKS database <http://blocks.fhcrc.org/>.

Sean Eddy recently wrote a paper reviewing the BLOSUM62 substitution matrix and how to calculate the scores [Eddy, 2004].

Use of scoring matrices

Deciding which scoring matrix you should use in order of obtain the best alignment results is a difficult task. If you have no prior knowledge on the sequence the BLOSUM62 is probably the best choice. This matrix has become the *de facto* standard for scoring matrices and is also used as the default matrix in BLAST searches. The selection of a "wrong" scoring matrix will most

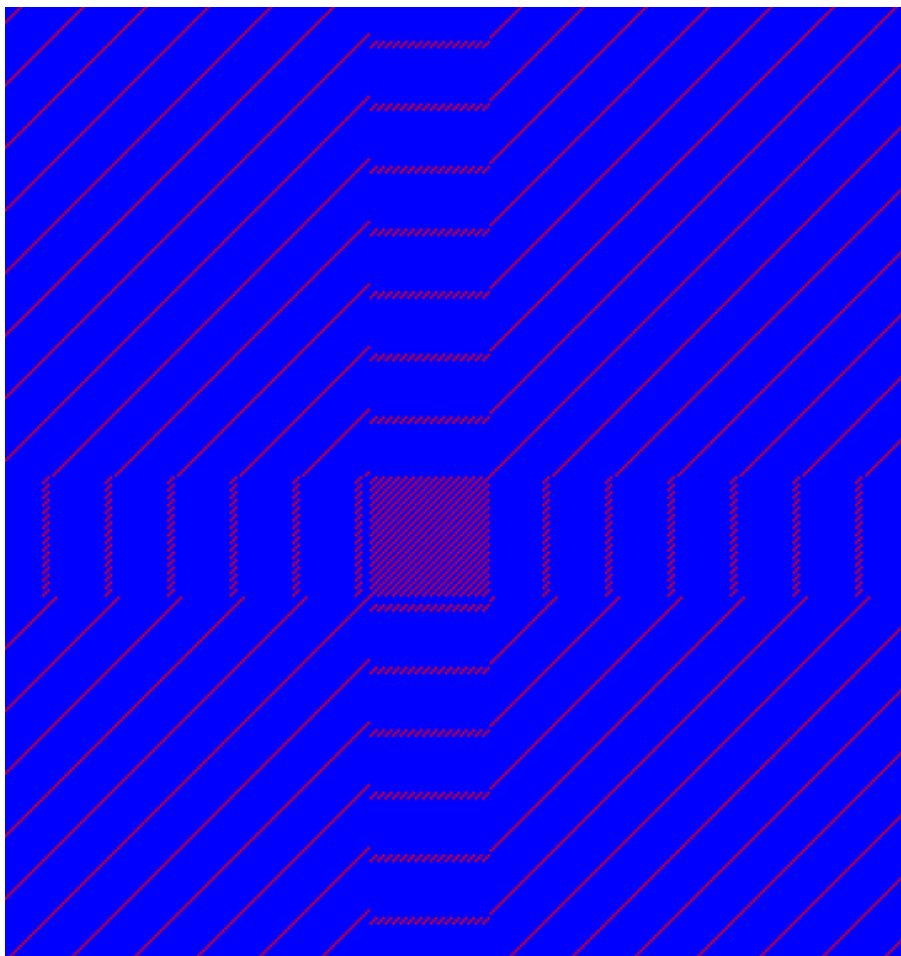

Figure 13.16: The dot plot showing a low-complexity region in the sequence. The sequence is artificial and low complexity regions do not always show as a square.

probable strongly influence on the outcome of the analysis. In general a few rules apply to the selection of scoring matrices.

- For closely related sequences choose BLOSUM matrices created for highly similar alignments, like BLOSUM80. You can also select low PAM matrices such as PAM1.
- For distant related sequences, select low BLOSUM matrices (for example BLOSUM45) or high PAM matrices such as PAM250.

The BLOSUM matrices with low numbers correspond to PAM matrices with high numbers. (See figure 13.17) for correlations between the PAM and BLOSUM matrices. To summarize, if you want to find distant related proteins to a sequence of interest using BLAST, you could benefit of using BLOSUM45 or similar matrices.

Other useful resources

BLOKS database

<http://blocks.fhcrc.org/>

NCBI help site

http://blast.ncbi.nlm.nih.gov/Blast.cgi?CMD=Web&PAGE_TYPE=BlastDocs

	A	R	N	D	C	Q	E	G	H	I	L	K	M	F	P	S	T	W	Y	V
A	4	-1	-2	-2	0	-1	-1	0	-2	-1	-1	-1	-1	-2	-1	1	0	-3	-2	0
R	-1	5	0	-2	-3	1	0	-2	0	-3	-2	2	-1	-3	-2	-1	-1	-3	-2	-3
N	-2	0	6	1	-3	0	0	0	1	-3	-3	0	-2	-3	-2	1	0	-4	-2	-3
D	-2	-2	1	6	-3	0	2	-1	-1	-3	-4	-1	-3	-3	-1	0	-1	-4	-3	-3
C	0	-3	-3	-3	9	-3	-4	-3	-3	-1	-1	-3	-1	-2	-3	-1	-1	-2	-2	-1
Q	-1	1	0	0	-3	5	2	-2	0	-3	-2	1	0	-3	-1	0	-1	-2	-1	-2
E	-1	0	0	2	-4	2	5	-2	0	-3	-3	1	-2	-3	-1	0	-1	-3	-2	-2
G	0	-2	0	-1	-3	-2	-2	6	-2	-4	-4	-2	-3	-3	-2	0	-2	-2	-3	-3
H	-2	0	1	-1	-3	0	0	-2	8	-3	-3	-1	-2	-1	-2	-1	-2	-2	2	-3
I	-1	-3	-3	-3	-1	-3	-3	-4	-3	4	2	-3	1	0	-3	-2	-1	-3	-1	3
L	-1	-2	-3	-4	-1	-2	-3	-4	-3	2	4	-2	2	0	-3	-2	-1	-2	-1	1
K	-1	2	0	-1	-3	1	1	-2	-1	-3	-2	5	-1	-3	-1	0	-1	-3	-2	-2
M	-1	-1	-2	-3	-1	0	-2	-3	-2	1	2	-1	5	0	-2	-1	-1	-1	-1	1
F	-2	-3	-3	-3	-2	-3	-3	-3	-1	0	0	-3	0	6	-4	-2	-2	1	3	-1
P	-1	-2	-2	-1	-3	-1	-1	-2	-2	-3	-3	-1	-2	-4	7	-1	-1	-4	-3	-2
S	1	-1	1	0	-1	0	0	0	-1	-2	-2	0	-1	-2	-1	4	1	-3	-2	-2
T	0	-1	0	-1	-1	-1	-1	-2	-2	-1	-1	-1	-1	-2	-1	1	5	-2	-2	0
W	-3	-3	-4	-4	-2	-2	-3	-2	-2	-3	-2	-3	-1	1	-4	-3	-2	11	2	-3
Y	-2	-2	-2	-3	-2	-1	-2	-3	2	-1	-1	-2	-1	3	-3	-2	-2	2	7	-1
V	0	-3	-3	-3	-1	-2	-2	-3	-3	3	1	-2	1	-1	-2	-2	0	-3	-1	4

Table 13.1: **The BLOSUM62 matrix.** A tabular view of the BLOSUM62 matrix containing all possible substitution scores [Henikoff and Henikoff, 1992].

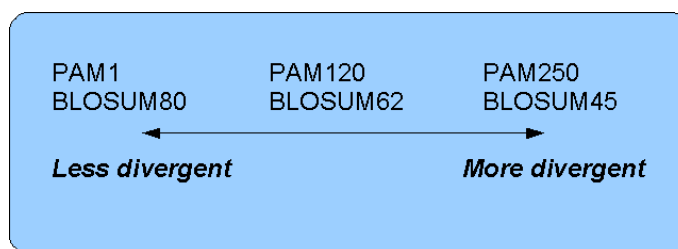

Figure 13.17: Relationship between scoring matrices. The BLOSUM62 has become a de facto standard scoring matrix for a wide range of alignment programs. It is the default matrix in BLAST.

13.5 Local complexity plot

In *CLC Genomics Workbench* it is possible to calculate local complexity for both DNA and protein sequences. The local complexity is a measure of the diversity in the composition of amino acids within a given range (window) of the sequence. The K2 algorithm is used for calculating local complexity [Wootton and Federhen, 1993]. To conduct a complexity calculation do the following:

Toolbox | Classical Sequence Analysis (📁) | **General Sequence Analysis** (📁) | **Create Complexity Plot** (📊)

This opens a dialog. In **Step 1** you can use the arrows to change, remove and add DNA and protein sequences in the **Selected Elements** window.

When the relevant sequences are selected, clicking **Next** takes you to **Step 2**. This step allows you to adjust the window size from which the complexity plot is calculated. Default is set to 11 amino acids and the number should always be odd. The higher the number, the less volatile the graph.

Figure 13.18 shows an example of a local complexity plot.

Click **Next** if you wish to adjust how to handle the results (see section 8.2). If not, click **Finish**.

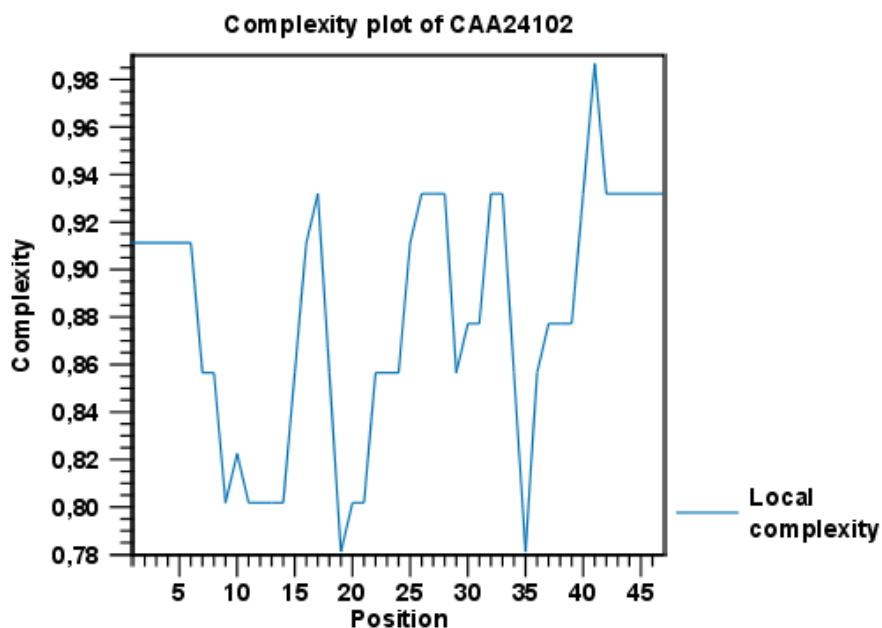

Figure 13.18: An example of a local complexity plot.

The values of the complexity plot approaches 1.0 as the distribution of amino acids become more complex.

See section B in the appendix for information about the graph view.

13.6 Sequence statistics

CLC Genomics Workbench can produce an output with many relevant statistics for protein sequences. Some of the statistics are also relevant to produce for DNA sequences. Therefore, this section deals with both types of statistics. The required steps for producing the statistics are the same.

To create a statistic for the sequence, do the following:

Toolbox | **Classical Sequence Analysis** (📁) | **General Sequence Analysis** (📁) | **Create Sequence Statistics** (📄)

This opens a dialog where you can alter your choice of sequences. If you had already selected sequences in the Navigation Area, these will be shown in the **Selected Elements** window. However you can remove these, or add others, by using the arrows to move sequences in or out of the **Selected Elements** window. You can also add sequence lists.

Note! You cannot create statistics for DNA and protein sequences at the same time; they must be run separately.

When the sequences are selected, click **Next**.

This opens the dialog displayed in figure 13.19.

The dialog offers to adjust the following parameters:

- **Individual statistics layout.** If more sequences were selected in **Step 1**, this function

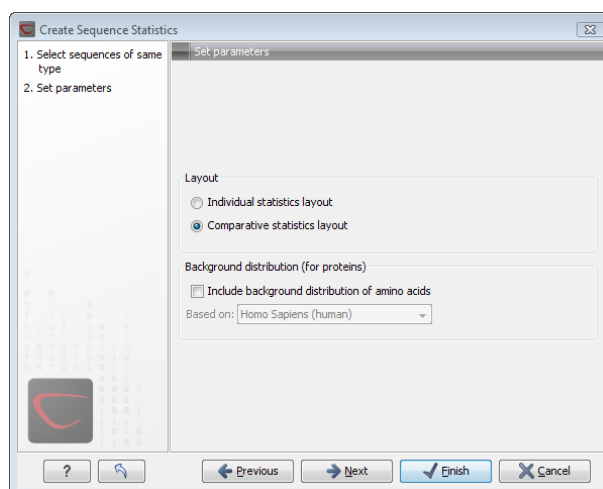

Figure 13.19: Setting parameters for the sequence statistics.

generates separate statistics for each sequence.

- **Comparative statistics layout.** If more sequences were selected in **Step 1**, this function generates statistics with comparisons between the sequences.

You can also choose to include Background distribution of amino acids. If this box is ticked, an extra column with amino acid distribution of the chosen species, is included in the table output. (The distributions are calculated from UniProt www.uniprot.org version 6.0, dated September 13 2005.)

Click **Next** if you wish to adjust how to handle the results (see section 8.2). If not, click **Finish**. An example of protein sequence statistics is shown in figure 13.20.

1 Protein statistics

1.1 Sequence information

Sequence type	Protein
Length	147
Organism	Mus musculus
Name	CAA32220
Description	haemoglobin beta-h0 chain [Mus musculus]
Modification Date	18-APR-2005
Weight	16,412 kDa

1.2 Half-life

N-terminal aa	Half-life mammals	Half-life yeast	Half-life E.Coli
---------------	-------------------	-----------------	------------------

Figure 13.20: Example of protein sequence statistics.

Nucleotide sequence statistics are generated using the same dialog as used for protein sequence statistics. However, the output of Nucleotide sequence statistics is less extensive than that of the protein sequence statistics.

Note! The headings of the tables change depending on whether you calculate 'individual' or 'comparative' sequence statistics.

The output of comparative protein sequence statistics include:

- Sequence information:

- Sequence type
 - Length
 - Organism
 - Name
 - Description
 - Modification Date
 - Weight. This is calculated like this: $sum_{unitsinsequence}(weight(unit)) - links * weight(H_2O)$ where `links` is the sequence length minus one and `units` are amino acids. The atomic composition is defined the same way.
 - Isoelectric point
 - Aliphatic index
- Half-life
 - Extinction coefficient
 - Counts of Atoms
 - Frequency of Atoms
 - Count of hydrophobic and hydrophilic residues
 - Frequencies of hydrophobic and hydrophilic residues
 - Count of charged residues
 - Frequencies of charged residues
 - Amino acid distribution
 - Histogram of amino acid distribution
 - Annotation table
 - Counts of di-peptides
 - Frequency of di-peptides
- Sequence Information:
 - Sequence type
 - Length
 - Organism
 - Name
 - Description
 - Modification Date
 - Weight
 - Isoelectric point
 - Aliphatic index

- Amino acid distribution
- Annotation table

The output of nucleotide sequence statistics include:

- General statistics:
 - Sequence type
 - Length
 - Organism
 - Name
 - Description
 - Modification Date
 - Weight. This is calculated like this: $sum_{unitsinsequence}(weight(unit)) - links * weight(H_2O)$ where `links` is the sequence length minus one for linear sequences and sequence length for circular molecules. The `units` are monophosphates. Both the weight for single- and double stranded molecules are included. The atomic composition is defined the same way.
- Atomic composition
- Nucleotide distribution table
- Nucleotide distribution histogram
- Annotation table
- Counts of di-nucleotides
- Frequency of di-nucleotides
- General statistics:
 - Sequence type
 - Length
 - Organism
 - Name
 - Description
 - Modification Date
 - Weight (calculated as single-stranded DNA)
- Nucleotide distribution table
- Annotation table

If nucleotide sequences are used as input, and these are annotated with CDS, a section on Codon statistics for Coding Regions is included.

A short description of the different areas of the statistical output is given in section [13.6.1](#).

13.6.1 Bioinformatics explained: Protein statistics

Every protein holds specific and individual features which are unique to that particular protein. Features such as isoelectric point or amino acid composition can reveal important information of a novel protein. Many of the features described below are calculated in a simple way.

Molecular weight

The molecular weight is the mass of a protein or molecule. The molecular weight is simply calculated as the sum of the atomic mass of all the atoms in the molecule.

The weight of a protein is usually represented in Daltons (Da).

A calculation of the molecular weight of a protein does not usually include additional posttranslational modifications. For native and unknown proteins it tends to be difficult to assess whether posttranslational modifications such as glycosylations are present on the protein, making a calculation based solely on the amino acid sequence inaccurate. The molecular weight can be determined very accurately by mass-spectrometry in a laboratory.

Isoelectric point

The isoelectric point (pI) of a protein is the pH where the proteins has no net charge. The pI is calculated from the pKa values for 20 different amino acids. At a pH below the pI, the protein carries a positive charge, whereas if the pH is above pI the proteins carry a negative charge. In other words, pI is high for basic proteins and low for acidic proteins. This information can be used in the laboratory when running electrophoretic gels. Here the proteins can be separated, based on their isoelectric point.

Aliphatic index

The aliphatic index of a protein is a measure of the relative volume occupied by aliphatic side chain of the following amino acids: alanine, valine, leucine and isoleucine. An increase in the aliphatic index increases the thermostability of globular proteins. The index is calculated by the following formula.

$$\text{Aliphatic index} = X(\text{Ala}) + a * X(\text{Val}) + b * X(\text{Leu}) + b * (X)\text{Ile}$$

$X(\text{Ala})$, $X(\text{Val})$, $X(\text{Ile})$ and $X(\text{Leu})$ are the amino acid compositional fractions. The constants a and b are the relative volume of valine (a=2.9) and leucine/isoleucine (b=3.9) side chains compared to the side chain of alanine [Ikai, 1980].

Estimated half-life

The half life of a protein is the time it takes for the protein pool of that particular protein to be reduced to the half. The half life of proteins is highly dependent on the presence of the N-terminal amino acid, thus overall protein stability [Bachmair et al., 1986, Gonda et al., 1989, Tobias et al., 1991]. The importance of the N-terminal residues is generally known as the 'N-end rule'. The N-end rule and consequently the N-terminal amino acid, simply determines the half-life of proteins. The estimated half-life of proteins have been investigated in mammals, yeast and *E. coli* (see Table 13.2). If leucine is found N-terminally in mammalian proteins the estimated half-life is 5.5 hours.

Amino acid	Mammalian	Yeast	E. coli
Ala (A)	4.4 hour	>20 hours	>10 hours
Cys (C)	1.2 hours	>20 hours	>10 hours
Asp (D)	1.1 hours	3 min	>10 hours
Glu (E)	1 hour	30 min	>10 hours
Phe (F)	1.1 hours	3 min	2 min
Gly (G)	30 hours	>20 hours	>10 hours
His (H)	3.5 hours	10 min	>10 hours
Ile (I)	20 hours	30 min	>10 hours
Lys (K)	1.3 hours	3 min	2 min
Leu (L)	5.5 hours	3 min	2 min
Met (M)	30 hours	>20 hours	>10 hours
Asn (N)	1.4 hours	3 min	>10 hours
Pro (P)	>20 hours	>20 hours	?
Gln (Q)	0.8 hour	10 min	>10 hours
Arg (R)	1 hour	2 min	2 min
Ser (S)	1.9 hours	>20 hours	>10 hours
Thr (T)	7.2 hours	>20 hours	>10 hours
Val (V)	100 hours	>20 hours	>10 hours
Trp (W)	2.8 hours	3 min	2 min
Tyr (Y)	2.8 hours	10 min	2 min

Table 13.2: **Estimated half life.** Half life of proteins where the N-terminal residue is listed in the first column and the half-life in the subsequent columns for mammals, yeast and *E. coli*.

Extinction coefficient

This measure indicates how much light is absorbed by a protein at a particular wavelength. The extinction coefficient is measured by UV spectrophotometry, but can also be calculated. The amino acid composition is important when calculating the extinction coefficient. The extinction coefficient is calculated from the absorbance of cysteine, tyrosine and tryptophan using the following equation:

$$Ext(Protein) = count(Cysteine) * Ext(Cysteine) + count(Tyr) * Ext(Tyr) + count(Trp) * Ext(Trp)$$

where Ext is the extinction coefficient of amino acid in question. At 280nm the extinction coefficients are: Cys=120, Tyr=1280 and Trp=5690.

This equation is only valid under the following conditions:

- pH 6.5
- 6.0 M guanidium hydrochloride
- 0.02 M phosphate buffer

The extinction coefficient values of the three important amino acids at different wavelengths are found in [Gill and von Hippel, 1989].

Knowing the extinction coefficient, the absorbance (optical density) can be calculated using the following formula:

$$\text{Absorbance}(\text{Protein}) = \frac{\text{Ext}(\text{Protein})}{\text{Molecular weight}}$$

Two values are reported. The first value is computed assuming that all cysteine residues appear as half cystines, meaning they form di-sulfide bridges to other cysteines. The second number assumes that no di-sulfide bonds are formed.

Atomic composition

Amino acids are indeed very simple compounds. All 20 amino acids consist of combinations of only five different atoms. The atoms which can be found in these simple structures are: Carbon, Nitrogen, Hydrogen, Sulfur, Oxygen. The atomic composition of a protein can for example be used to calculate the precise molecular weight of the entire protein.

Total number of negatively charged residues (Asp+Glu)

At neutral pH, the fraction of negatively charged residues provides information about the location of the protein. Intracellular proteins tend to have a higher fraction of negatively charged residues than extracellular proteins.

Total number of positively charged residues (Arg+Lys)

At neutral pH, nuclear proteins have a high relative percentage of positively charged amino acids. Nuclear proteins often bind to the negatively charged DNA, which may regulate gene expression or help to fold the DNA. Nuclear proteins often have a low percentage of aromatic residues [Andrade et al., 1998].

Amino acid distribution

Amino acids are the basic components of proteins. The amino acid distribution in a protein is simply the percentage of the different amino acids represented in a particular protein of interest. Amino acid composition is generally conserved through family-classes in different organisms which can be useful when studying a particular protein or enzymes across species borders. Another interesting observation is that amino acid composition variate slightly between proteins from different subcellular localizations. This fact has been used in several computational methods, used for prediction of subcellular localization.

Annotation table

This table provides an overview of all the different annotations associated with the sequence and their incidence.

Dipeptide distribution

This measure is simply a count, or frequency, of all the observed adjacent pairs of amino acids (dipeptides) found in the protein. It is only possible to report neighboring amino acids. Knowledge on dipeptide composition have previously been used for prediction of subcellular localization.

13.7 Join sequences

CLC Genomics Workbench can join several nucleotide or protein sequences into one sequence. This feature can for example be used to construct "supergenes" for phylogenetic inference by joining several disjoint genes into one. Note, that when sequences are joined, all their annotations are carried over to the new spliced sequence.

Two (or more) sequences can be joined by:

Toolbox | General Sequence Analyses | Join sequences (🌿)

This opens the dialog shown in figure 13.21.

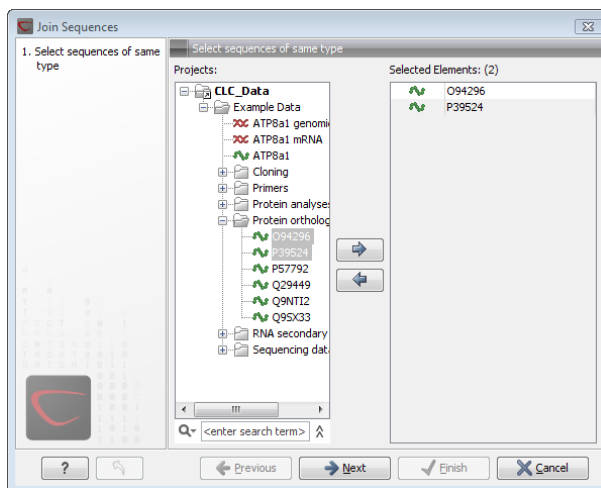

Figure 13.21: Selecting two sequences to be joined.

If you have selected some sequences before choosing the Toolbox action, they are now listed in the **Selected Elements** window of the dialog. Use the arrows to add or remove sequences from the selected elements. Click **Next** opens the dialog shown in figure 13.22.

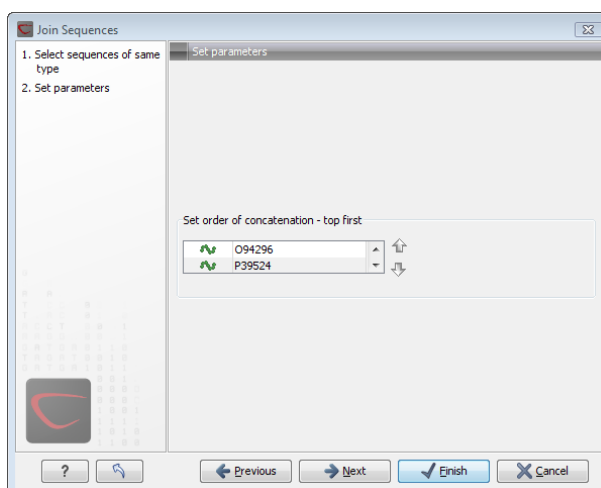

Figure 13.22: Setting the order in which sequences are joined.

In step 2 you can change the order in which the sequences will be joined. Select a sequence and use the arrows to move the selected sequence up or down.

Click **Next** if you wish to adjust how to handle the results (see section 8.2). If not, click **Finish**.

The result is shown in figure 13.23.

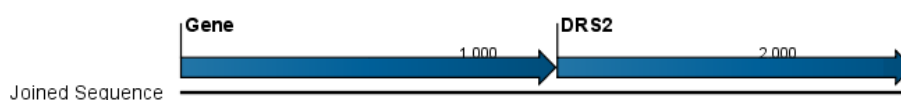

Figure 13.23: The result of joining sequences is a new sequence containing the annotations of the joined sequences (they each had a HBB annotation).

13.8 Pattern discovery

With *CLC Genomics Workbench* you can perform pattern discovery on both DNA and protein sequences. Advanced hidden Markov models can help to identify unknown sequence patterns across single or even multiple sequences.

In order to search for unknown patterns:

Toolbox | Classical Sequence Analysis (📁) | General Sequence Analysis (📁) | Pattern Discovery (🔍)

If a sequence was selected before choosing the Toolbox action, the sequence is now listed in the **Selected Elements** window of the dialog. Use the arrows to add or remove sequences or sequence lists from the selected elements.

You can perform the analysis on several DNA or several protein sequences at a time. If the analysis is performed on several sequences at a time the method will search for patterns which is common between all the sequences. Annotations will be added to all the sequences and a view is opened for each sequence.

Click **Next** to adjust parameters (see figure 13.24).

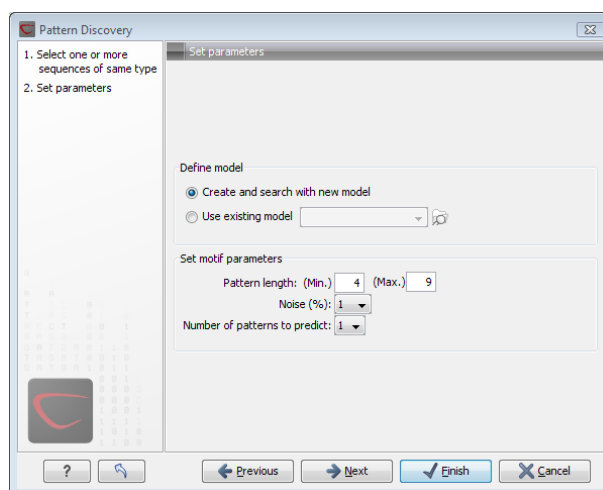

Figure 13.24: Setting parameters for the pattern discovery. See text for details.

In order to search unknown sequences with an already existing model:

Select to use an already existing model which is seen in figure 13.24. Models are represented with the following icon in the **Navigation Area** (📁).

13.8.1 Pattern discovery search parameters

Various parameters can be set prior to the pattern discovery. The parameters are listed below and a screenshot of the parameter settings can be seen in figure 13.24.

- **Create and search with new model.** This will create a new HMM model based on the selected sequences. The found model will be opened after the run and presented in a table view. It can be saved and used later if desired.
- **Use existing model.** It is possible to use already created models to search for the same pattern in new sequences.
- **Minimum pattern length.** Here, the minimum length of patterns to search for, can be specified.
- **Maximum pattern length.** Here, the maximum length of patterns to search for, can be specified.
- **Noise (%).** Specify noise-level of the model. This parameter has influence on the level of degeneracy of patterns in the sequence(s). The noise parameter can be 1,2,5 or 10 percent.
- **Number of different kinds of patterns to predict.** Number of iterations the algorithm goes through. After the first iteration, we force predicted pattern-positions in the first run to be member of the background: In that way, the algorithm finds new patterns in the second iteration. Patterns marked 'Pattern1' have the highest confidence. The maximal iterations to go through is 3.
- **Include background distribution.** For protein sequences it is possible to include information on the background distribution of amino acids from a range of organisms.

Click **Next** if you wish to adjust how to handle the results (see section 8.2). If not, click **Finish**. This will open a view showing the patterns found as annotations on the original sequence (see figure 13.25). If you have selected several sequences, a corresponding number of views will be opened.



```
      Pattern1      Pattern1
      ┌──────────┐  ┌──────────┐
      │          │  │          │
      │          │  │          │
      │          │  │          │
      │          │  │          │
      │          │  │          │
      └──────────┘  └──────────┘
3VCNKNQTA EDLAWSYGFP ECARFLTMIK CMQTARSSGE
```

Figure 13.25: Sequence view displaying two discovered patterns.

13.8.2 Pattern search output

If the analysis is performed on several sequences at a time the method will search for patterns in the sequences and open a new view for each of the sequences, in which a pattern was discovered. Each novel pattern will be represented as an annotation of the type **Region**. More information on each found pattern is available through the tool-tip, including detailed information on the position of the pattern and quality scores.

It is also possible to get a tabular view of all found patterns in one combined table. Then each found pattern will be represented with various information on obtained scores, quality of the pattern and position in the sequence.

A table view of emission values of the actual used HMM model is presented in a table view. This model can be saved and used to search for a similar pattern in new or unknown sequences.

13.9 Motif Search

CLC Genomics Workbench offers advanced and versatile options to search for known motifs represented either by a simple sequence or a more advanced regular expression. These advanced search capabilities are available for use in both DNA and protein sequences.

There are two ways to access this functionality:

- When viewing sequences, it is possible to have motifs calculated and shown on the sequence in a similar way as restriction sites (see section 18.3.1). This approach is called *Dynamic motifs* and is an easy way to spot known sequence motifs when working with sequences for cloning etc.
- A more refined and systematic search for motifs can be performed through the **Toolbox**. This will generate a table and optionally add annotations to the sequences.

The two approaches are described below.

13.9.1 Dynamic motifs

In the **Side Panel** of sequence views, there is a group called **Motifs** (see figure 13.26).

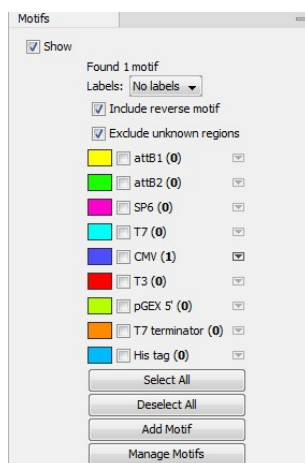

Figure 13.26: Dynamic motifs in the Side Panel.

The Workbench will look for the listed motifs in the sequence that is open and by clicking the check box next to the motif it will be shown in the view as illustrated in figure 13.27.

This case shows the CMV promoter primer sequence which is one of the pre-defined motifs in *CLC Genomics Workbench*. The motif is per default shown as a faded arrow with no text. The direction of the arrow indicates the strand of the motif.

```

      380          400          420
    CCCATTGACGTCAATGGGAGTTTGTGTTTGGCACCAAATCAACGGGACTTTCC
      440          460
    AAAATGTCGTAACAACTCCGCCCCATTGACGCAAAATGGGCGGTAGGCGTGTAC
      480          500          520
    GGTGGGAGGTCTATATAAGCAGAGCTCGTTTAGTGAACCGTCAAGATCGCCTGG
  
```

Figure 13.27: Showing dynamic motifs on the sequence.

Placing the mouse cursor on the arrow will display additional information about the motif as illustrated in figure 13.28.

```

>CCCCATTGACGCAAAATGGGCGGTAGGCGTGTACGGTGGGAGG
  
```

/motif=CGCAAATGGGCGGTAGGCGTG, list index: 5 (CMV);
 /type=Simple
 /description=CMV promoter primer

Figure 13.28: Showing dynamic motifs on the sequence.

To add **Labels** to the motif, select the **Flag** or **Stacked** option. They will put the name of the motif as a flag above the sequence. The stacked option will stack the labels when there is more than one motif so that all labels are shown.

Below the labels option there are two options for controlling the way the sequence should be searched for motifs:

- **Include reverse motifs.** This will also find motifs on the negative strand (only available for nucleotide sequences)
- **Exclude matches in N-regions for simple motifs.** The motif search handles ambiguous characters in the way that two residues are different if they do not have any residues in common. For example: For nucleotides, *N* matches any character and *R* matches *A,G*. For proteins, *X* matches any character and *Z* matches *E,Q*. Genome sequence often have large regions with unknown sequence. These regions are very often padded with *N*'s. Ticking this checkbox will not display hits found in *N*-regions and if a one residue in a motif matches to an *N*, it will be treated as a mismatch.

The list of motifs shown in figure 13.26 is a pre-defined list that is included with the *CLC Genomics Workbench*. You can define your own set of motifs to use instead. In order to do this, you can either click on the **Add Motif** button in the side panel (see figure 13.26) and directly define and add motifs of choice as illustrated in figure 13.32. Alternatively, you can create and save a **Motif list** (📄) (see section 13.10). Subsequently, in the sequence view click the **Manage Motifs** button in the side panel which will bring up the dialog shown in figure 13.29.

At the top, select a motif list by clicking the **Browse** (📁) button. When the motif list is selected, its motifs are listed in the panel in the left-hand side of the dialog. The right-hand side panel contains the motifs that will be listed in the **Side Panel** when you click **Finish**.

13.9.2 Motif search from the Toolbox

The dynamic motifs described in section 13.9.1 provide a quick way of routinely scanning a sequence for commonly used motifs, but in some cases a more systematic approach is needed.

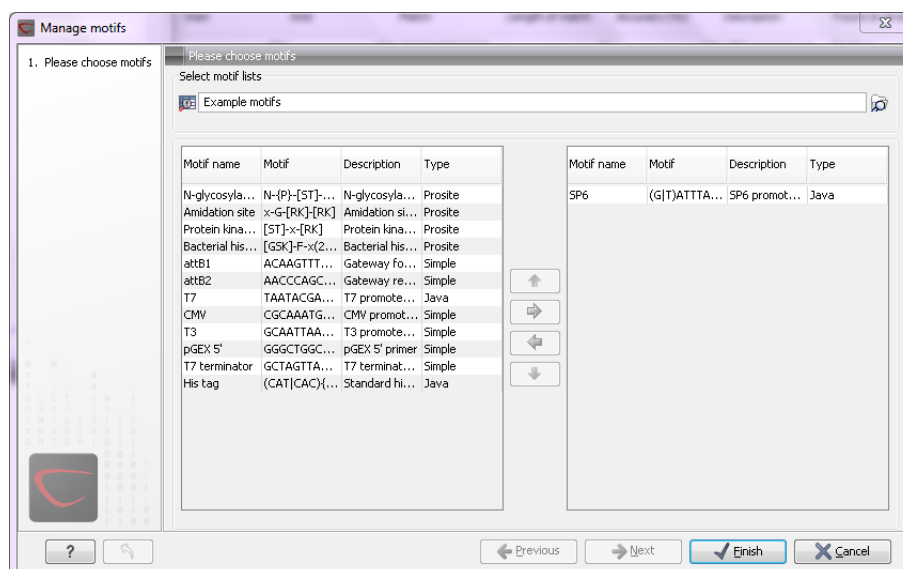

Figure 13.29: Managing the motifs to be shown.

The motif search in the **Toolbox** provides an option to search for motifs with a user-specified similarity to the target sequence, and furthermore the motifs found can be displayed in an overview table. This is particularly useful when searching for motifs on many sequences.

To start the Toolbox motif search, go to:

Toolbox | **Classical Sequence Analysis** (🗂️) | **General Sequence Analysis** (🗂️) | **Motif Search** (🔍)

A dialog window will be launched. Use the arrows to add or remove sequences or sequence lists between the Navigation Area and the selected elements.

You can perform the analysis on several DNA or several protein sequences at a time. In this case, the method will search for patterns in the sequences and create an overview table of the motifs found in all sequences.

Click **Next** to adjust parameters (see figure 13.30).

The options for the motif search are:

- **Motif types.** Choose what kind of motif to be used:
 - Simple motif. Choosing this option means that you enter a simple motif, e.g. ATGATGNATG.
 - Java regular expression. See section 13.9.3.
 - Prosite regular expression. For proteins, you can enter different protein patterns from the PROSITE database (protein patterns using regular expressions and describing specific amino acid sequences). The PROSITE database contains a great number of patterns and have been used to identify related proteins (see <http://www.expasy.org/cgi-bin/prosite-list.pl>).
 - Use motif list. Clicking the small button (🗂️) will allow you to select a saved motif list (see section 13.10).
- **Motif.** If you choose to search with a simple motif, you should enter a literal string as your

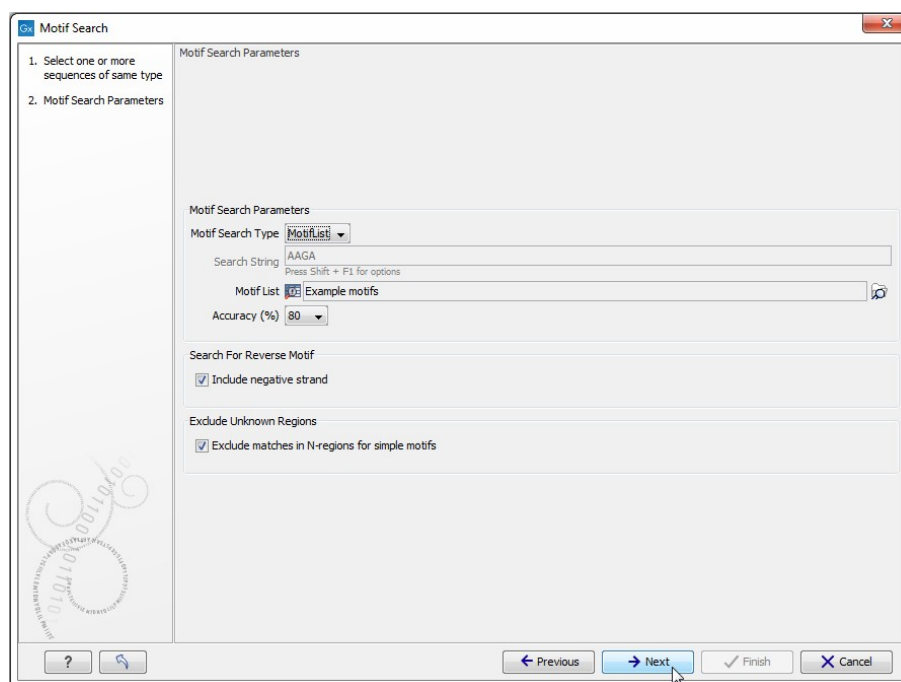

Figure 13.30: Setting parameters for the motif search.

motif. Ambiguous amino acids and nucleotides are allowed. Example; ATGATGNNATG. If your motif type is Java regular expression, you should enter a regular expression according to the syntax rules described in section 13.9.3. Press **Shift + F1** key for options. For proteins, you can search with a Prosite regular expression and you should enter a protein pattern from the PROSITE database.

- **Accuracy.** If you search with a simple motif, you can adjust the accuracy of the motif to the match on the sequence. If you type in a simple motif and let the accuracy be 80%, the motif search algorithm runs through the input sequence and finds all subsequences of the same length as the simple motif such that the fraction of identity between the subsequence and the simple motif is at least 80%. A motif match is added to the sequence as an annotation with the exact fraction of identity between the subsequence and the simple motif. If you use a list of motifs, the accuracy applies only to the simple motifs in the list.
- **Search for reverse motif.** This enables searching on the negative strand on nucleotide sequences.
- **Exclude unknown regions.** Genome sequence often have large regions with unknown sequence. These regions are very often padded with N's. Ticking this checkbox will not display hits found in N-regions. Motif search handles ambiguous characters in the way that two residues are different if they do not have any residues in common. For example: For nucleotides, *N* matches any character and *R* matches A,G. For proteins, *X* matches any character and *Z* matches E,Q.

Click **Next** to adjust how to handle the results and then click **Finish**. There are two types of results that can be produced:

- **Add annotations.** This will add an annotation to the sequence when a motif is found (an example is shown in figure 13.31).

- **Create table.** This will create an overview table of all the motifs found for all the input sequences.

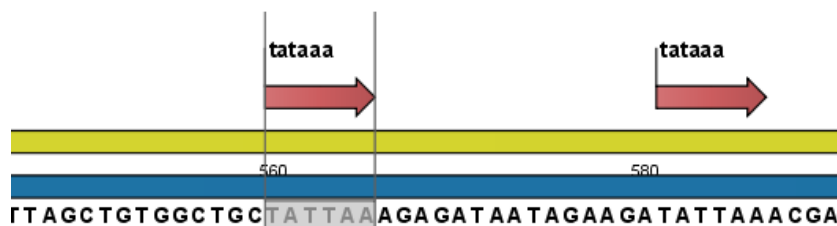

Figure 13.31: Sequence view displaying the pattern found. The search string was 'tataaa'.

13.9.3 Java regular expressions

A regular expressions is a string that describes or matches a set of strings, according to certain syntax rules. They are usually used to give a concise description of a set, without having to list all elements. The simplest form of a regular expression is a literal string. The syntax used for the regular expressions is the Java regular expression syntax (see <http://java.sun.com/docs/books/tutorial/essential/regex/index.html>). Below is listed some of the most important syntax rules which are also shown in the help pop-up when you press Shift + F1:

`[A-Z]` will match the characters A through Z (Range). You can also put single characters between the brackets: The expression `[AGT]` matches the characters A, G or T.

`[A-D[M-P]]` will match the characters A through D and M through P (Union). You can also put single characters between the brackets: The expression `[AG[M-P]]` matches the characters A, G and M through P.

`[A-M&&[H-P]]` will match the characters between A and M lying between H and P (Intersection). You can also put single characters between the brackets. The expression `[A-M&&[HGTDA]]` matches the characters A through M which is H, G, T, D or A.

`[^A-M]` will match any character except those between A and M (Excluding). You can also put single characters between the brackets: The expression `[^AG]` matches any character except A and G.

`[A-Z&&[^M-P]]` will match any character A through Z except those between M and P (Subtraction). You can also put single characters between the brackets: The expression `[A-P&&[^CG]]` matches any character between A and P except C and G.

The symbol `.` matches any character.

`X{n}` will match a repetition of an element indicated by following that element with a numerical value or a numerical range between the curly brackets. For example, `ACG{2}` matches the string `ACGG` and `(ACG){2}` matches `ACGACG`.

`X{n,m}` will match a certain number of repetitions of an element indicated by following that element with two numerical values between the curly brackets. The first number is a lower limit on the number of repetitions and the second number is an upper limit on the number of repetitions. For example, `ACT{1,3}` matches `ACT`, `ACTT` and `ACTTT`.

$X\{n,\}$ represents a repetition of an element at least n times. For example, $(AC)\{2,\}$ matches all strings $ACAC$, $ACACAC$, $ACACACAC$,...

The symbol \wedge restricts the search to the beginning of your sequence. For example, if you search through a sequence with the regular expression $\wedge AC$, the algorithm will find a match if AC occurs in the beginning of the sequence.

The symbol $\$$ restricts the search to the end of your sequence. For example, if you search through a sequence with the regular expression $GT\$$, the algorithm will find a match if GT occurs in the end of the sequence.

Examples

The expression $[ACG][\wedge AC]G\{2\}$ matches all strings of length 4, where the first character is A,C or G and the second is any character except A,C and the third and fourth character is G . The expression $G.[\wedge A]\$$ matches all strings of length 3 in the end of your sequence, where the first character is C , the second any character and the third any character except A .

13.10 Create motif list

CLC Genomics Workbench offers advanced and versatile options to create lists of sequence patterns or known motifs, represented either by a literal string or a regular expression.

A motif list can be created using:

Toolbox | **Classical Sequence Analysis** (📁) | **General Sequence Analysis** (📁) | **Create Motif List** (📄)

Click on the **Add** (+) button at the bottom of the view. This will open a dialog shown in figure 13.32.

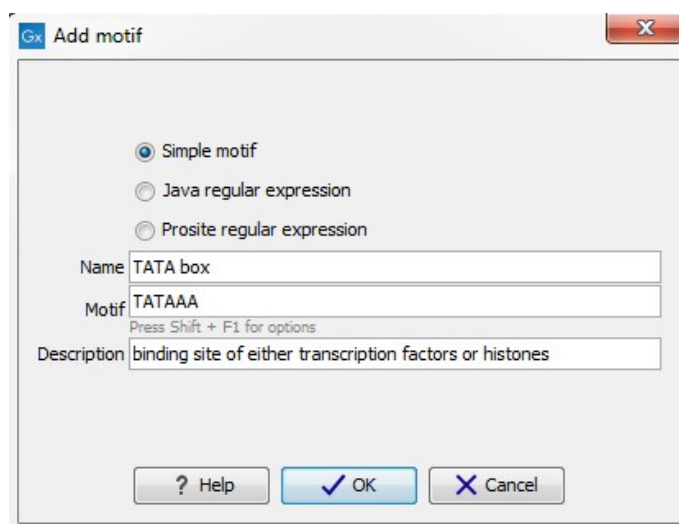



Figure 13.32: Entering a new motif in the list.

In this dialog, you can enter the following information:

- **Name.** The name of the motif. In the result of a motif search, this name will appear as the name of the annotation and in the result table.

- **Motif.** The actual motif. See section 13.9.2 for more information about the syntax of motifs.
- **Description.** You can enter a description of the motif. In the result of a motif search, the description will appear in the result table and will be added as a note to the annotation on the sequence (visible in the **Annotation table** ) or by placing the mouse cursor on the annotation).
- **Type.** You can enter three different types of motifs: Simple motifs, java regular expressions or PROSITE regular expression. Read more in section 13.9.2.

The motif list can contain a mix of different types of motifs. This is practical because some motifs can be described with the simple syntax, whereas others need the more advanced regular expression syntax.

Instead of manually adding motifs, you can **Import From Fasta File** . This will show a dialog where you can select a fasta file on your computer and use this to create motifs. This will automatically take the name, description and sequence information from the fasta file, and put it into the motif list. The motif type will be "simple".

Besides adding new motifs, you can also edit and delete existing motifs in the list. To edit a motif, either double-click the motif in the list, or select and click the **Edit**  button at the bottom of the view.

To delete a motif, select it and press the Delete key on the keyboard. Alternatively, click **Delete**  in the **Tool bar**.

Save the motif list in the **Navigation Area**, and you will be able to use for Motif Search  (see section 13.9).

Chapter 14

Nucleotide analyses

Contents

14.1 Convert DNA to RNA	341
14.2 Convert RNA to DNA	342
14.3 Reverse complements of sequences	343
14.4 Reverse sequence	343
14.5 Translation of DNA or RNA to protein	344
14.5.1 Translate part of a nucleotide sequence	346
14.6 Find open reading frames	346
14.6.1 Open reading frame parameters	347

CLC Genomics Workbench offers different kinds of sequence analyses, which only apply to DNA and RNA.

14.1 Convert DNA to RNA

CLC Genomics Workbench lets you convert a DNA sequence into RNA, substituting the T residues (Thymine) for U residues (Urasil):

Toolbox | Classical Sequence Analysis  | **Nucleotide Analysis**  | **Convert DNA to RNA** 

This opens the dialog displayed in figure 14.1:

If a sequence was selected before choosing the Toolbox action, this sequence is now listed in the **Selected Elements** window of the dialog. Use the arrows to add or remove sequences or sequence lists from the selected elements.

Click **Next** if you wish to adjust how to handle the results (see section 8.2). If not, click **Finish**.

Note! You can select multiple DNA sequences and sequence lists at a time. If the sequence list contains RNA sequences as well, they will not be converted.

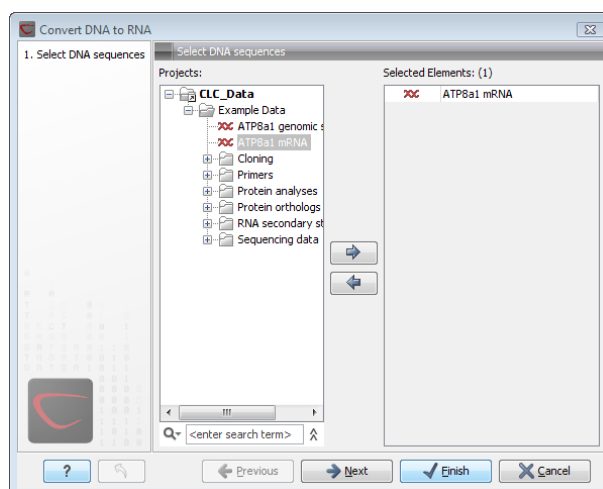

Figure 14.1: Translating DNA to RNA.

14.2 Convert RNA to DNA

CLC Genomics Workbench lets you convert an RNA sequence into DNA, substituting the U residues (Urasil) for T residues (Thymine):

Toolbox | **Classical Sequence Analysis** (📁) | **Nucleotide Analysis** (📁) | **Convert RNA to DNA** (🔗)

This opens the dialog displayed in figure 14.2:

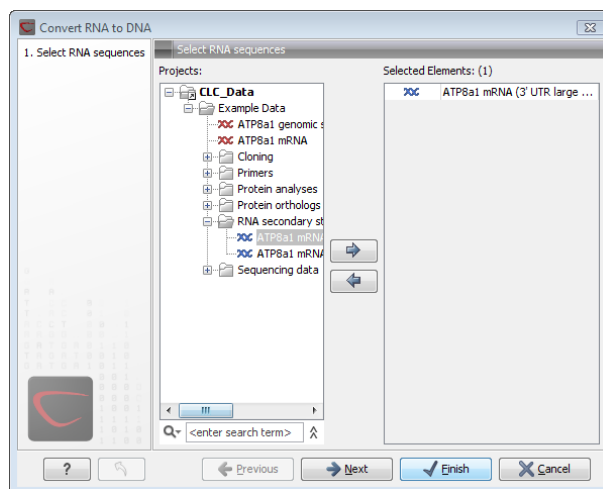

Figure 14.2: Translating RNA to DNA.

If a sequence was selected before choosing the Toolbox action, this sequence is now listed in the **Selected Elements** window of the dialog. Use the arrows to add or remove sequences or sequence lists from the selected elements.

Click **Next** if you wish to adjust how to handle the results (see section 8.2). If not, click **Finish**.

This will open a new view in the **View Area** displaying the new DNA sequence. The new sequence is not saved automatically. To save the sequence, drag it into the **Navigation Area** or press Ctrl + S (⌘ + S on Mac) to activate a save dialog.

Note! You can select multiple RNA sequences and sequence lists at a time. If the sequence list

contains DNA sequences as well, they will not be converted.

14.3 Reverse complements of sequences

CLC Genomics Workbench is able to create the reverse complement of a nucleotide sequence. By doing that, a new sequence is created which also has all the annotations reversed since they now occupy the opposite strand of their previous location.

To quickly obtain the reverse complement of a sequence or part of a sequence, you may select a region on the negative strand and open it in a new view:

right-click a selection on the negative strand | Open selection in New View (📄)

By doing that, the sequence will be reversed. This is only possible when the double stranded view option is enabled. It is possible to copy the selection and paste it in a word processing program or an e-mail. To obtain a reverse complement of an entire sequence:

Toolbox | Classical Sequence Analysis (📄) | **Nucleotide Analysis** (📄) | **Reverse Complement Sequence** (🔍)

This opens the dialog displayed in figure 14.3:

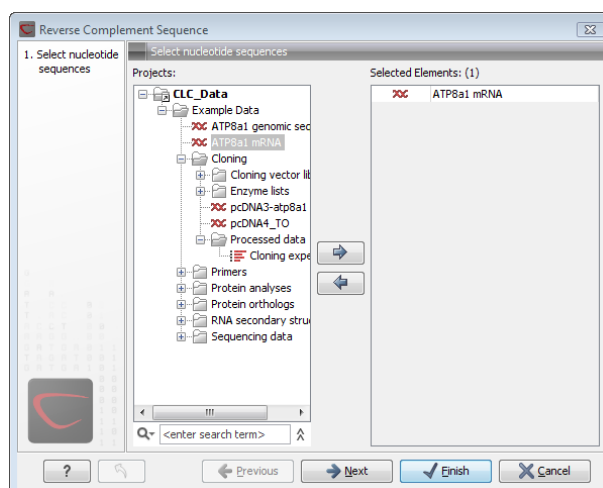

Figure 14.3: Creating a reverse complement sequence.

If a sequence was selected before choosing the Toolbox action, the sequence is now listed in the **Selected Elements** window of the dialog. Use the arrows to add or remove sequences or sequence lists from the selected elements.

Click **Next** if you wish to adjust how to handle the results (see section 8.2). If not, click **Finish**.

This will open a new view in the **View Area** displaying the reverse complement of the selected sequence. The new sequence is not saved automatically. To save the sequence, drag it into the **Navigation Area** or press Ctrl + S (⌘ + S on Mac) to activate a save dialog.

14.4 Reverse sequence

CLC Genomics Workbench is able to create the reverse of a nucleotide sequence.

Note! This is not the same as a reverse complement. If you wish to create the reverse complement, please refer to section 14.3.

To run the tool, go to:

Toolbox | Classical Sequence Analysis (📁) | Nucleotide Analysis (📁) | Reverse Sequence (🔍)

This opens the dialog displayed in figure 14.4:

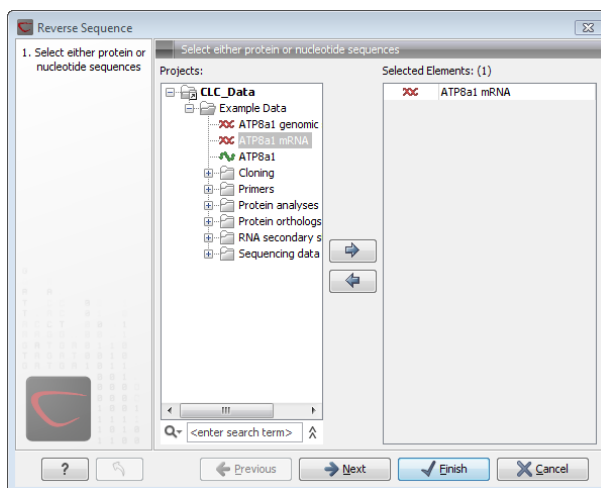

Figure 14.4: Reversing a sequence.

If a sequence was selected before choosing the Toolbox action, the sequence is now listed in the **Selected Elements** window of the dialog. Use the arrows to add or remove sequences or sequence lists from the selected elements.

Click **Next** if you wish to adjust how to handle the results (see section 8.2). If not, click **Finish**.

Note! This is not the same as a reverse complement. If you wish to create the reverse complement, please refer to section 14.3.

14.5 Translation of DNA or RNA to protein

In *CLC Genomics Workbench* you can translate a nucleotide sequence into a protein sequence using the **Toolbox** tools. Usually, you use the +1 reading frame which means that the translation starts from the first nucleotide. Stop codons result in an asterisk being inserted in the protein sequence at the corresponding position. It is possible to translate in any combination of the six reading frames in one analysis. To translate, go to:

Toolbox | Classical Sequence Analysis (📁) | Nucleotide Analysis (📁) | Translate to Protein (🔍)

This opens the dialog displayed in figure 14.5:

If a sequence was selected before choosing the Toolbox action, the sequence is now listed in the **Selected Elements** window of the dialog. Use the arrows to add or remove sequences or sequence lists from the selected elements.

Clicking **Next** generates the dialog seen in figure 14.6:

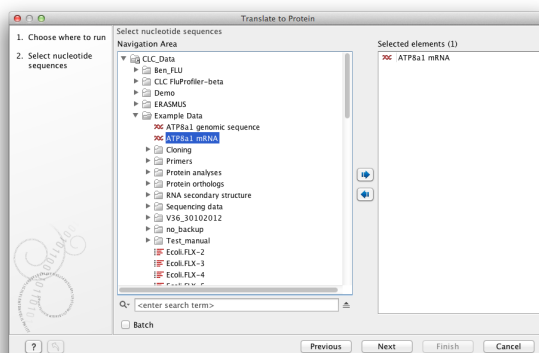

Figure 14.5: Choosing sequences for translation.

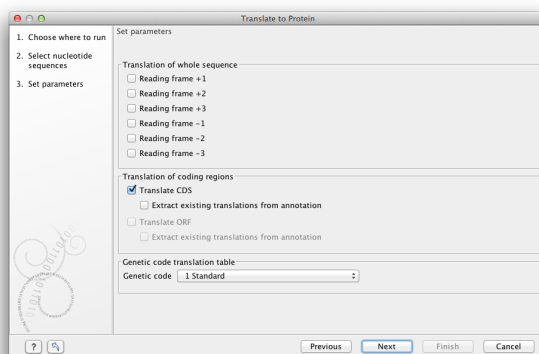

Figure 14.6: Choosing translation of CDS's using standard translation table.

Here you have the following options:

Reading frames If you wish to translate the whole sequence, you must specify the reading frame for the translation. If you select e.g. two reading frames, two protein sequences are generated.

Translate CDS You can choose to translate regions marked by and CDS or ORF annotation. This will generate a protein sequence for each CDS or ORF annotation on the sequence. The "Extract existing translations from annotation" allows to list the amino acid CDS sequence shown in the tool tip annotation (e.g. interstate from NCBI download) and does therefore not represent a translation of the actual nt sequence.

Genetic code translation table Lets you specify the genetic code for the translation. The translation tables are occasionally updated from NCBI. The tables are not available in this printable version of the user manual. Instead, the tables are included in the **Help**-menu in the **Menu Bar** (in the appendix).

Click **Next** if you wish to adjust how to handle the results (see section 8.2). If not, click **Finish**. The newly created protein is shown, but is not saved automatically.

To save a protein sequence, drag it into the **Navigation Area** or press Ctrl + S (⌘ + S on Mac) to activate a save dialog.

The name for a coding region translation consists of the name of the input sequence followed by the annotation type and finally the annotation name.

14.5.1 Translate part of a nucleotide sequence

If you want to make separate translations of *all* the coding regions of a nucleotide sequence, you can check the option: "Translate CDS and ORF" in the translation dialog (see figure 14.6).

If you want to translate a *specific* coding region, which is annotated on the sequence, use the following procedure:

Open the nucleotide sequence | right-click the ORF or CDS annotation | Translate CDS/ORF (👉) | choose a translation table | OK

If the annotation contains information about the translation, this information will be used, and you do not have to specify a translation table.

The CDS and ORF annotations are colored yellow as default.

14.6 Find open reading frames

The *CLC Genomics Workbench* **Find Open Reading Frames** function can be used to find all open reading frames (ORF) in a sequence, or, by choosing particular start codons to use, it can be used as a rudimentary gene finder. ORFs identified will be shown as annotations on the sequence. You have the option of choosing a translation table, the start codons to use, minimum ORF length as well as a few other parameters. These choices are explained in this section.

To find open reading frames:

Toolbox | Classical Sequence Analysis (👉) | Nucleotide Analysis (👉) | Find Open Reading Frames (👉)

This opens the dialog displayed in figure 14.7:

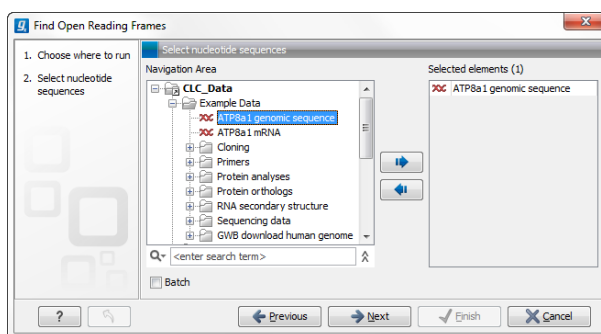

Figure 14.7: Create Reading Frame dialog.

If a sequence was selected before choosing the Toolbox action, the sequence is now listed in the **Selected Elements** window of the dialog. Use the arrows to add or remove sequences or sequence lists from the selected elements.

The **Find Open Reading Frames** tool simply looks for start and stop codons and reports any open reading frames that satisfy the parameters. If you want to adjust the parameters for finding open reading frames click **Next**.

14.6.1 Open reading frame parameters

This opens the dialog displayed in figure 14.8:

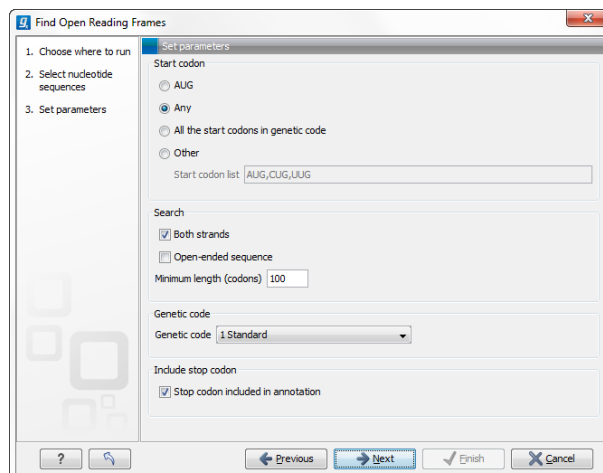

Figure 14.8: Create Reading Frame dialog.

The adjustable parameters for the search are:

- **Start codon:**
 - **AUG.** Most commonly used start codon.
 - **Any.** Find all open reading frames of specified length. Any combination of three bases that is not a stop-codon is interpreted as a start codon, and translated according to the specified genetic code.
 - **All start codons in genetic code.**
 - **Other.** Here you can specify a number of start codons separated by commas.
- **Both strands.** Finds reading frames on both strands.
- **Open-ended Sequence.** Allows the ORF to start or end outside the sequence. If the sequence studied is a part of a larger sequence, it may be advantageous to allow the ORF to start or end outside the sequence.
- **Genetic code translation table.**
- **Include stop codon in result** The ORFs will be shown as annotations which can include the stop codon if this option is checked. The translation tables are occasionally updated from NCBI. The tables are not available in this printable version of the user manual. Instead, the tables are included in the **Help**-menu in the **Menu Bar** (in the appendix).
- **Minimum Length.** Specifies the minimum length for the ORFs to be found. The length is specified as number of codons.

Using open reading frames for gene finding is a fairly simple approach which is likely to predict genes which are not real. Setting a relatively high minimum length of the ORFs will reduce the number of false positive predictions, but at the same time short genes may be missed (see figure 14.9).

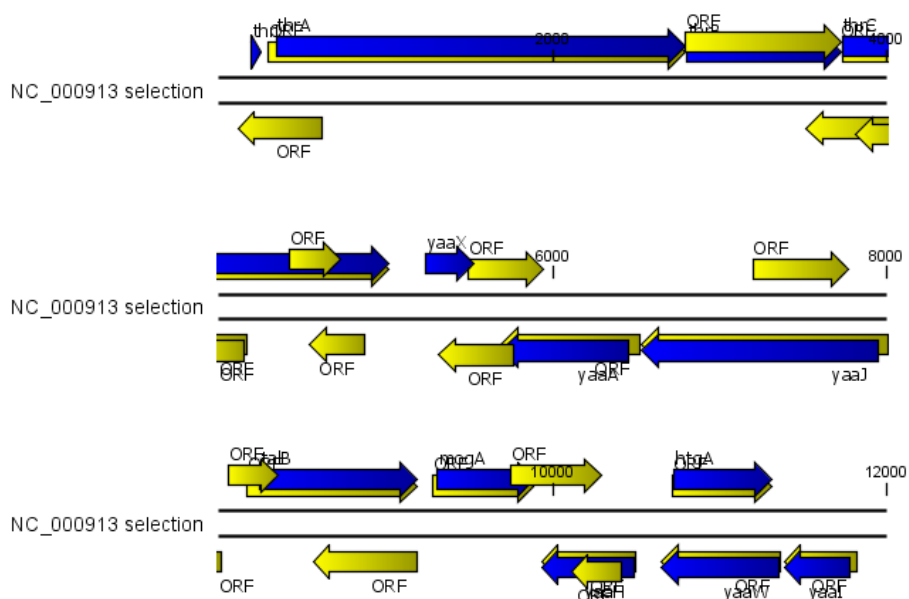

Figure 14.9: The first 12,000 positions of the *E. coli* sequence NC_000913 downloaded from GenBank. The blue (dark) annotations are the genes while the yellow (brighter) annotations are the ORFs with a length of at least 100 amino acids. On the positive strand around position 11,000, a gene starts before the ORF. This is due to the use of the standard genetic code rather than the bacterial code. This particular gene starts with CTG, which is a start codon in bacteria. Two short genes are entirely missing, while a handful of open reading frames do not correspond to any of the annotated genes.

Click **Next** if you wish to adjust how to handle the results (see section 8.2). If not, click **Finish**.

Finding open reading frames is often a good first step in annotating sequences such as cloning vectors or bacterial genomes. For eukaryotic genes, ORF determination may not always be very helpful since the intron/exon structure is not part of the algorithm.

Chapter 15

Protein analyses

Contents

15.1 Signal peptide prediction	350
15.2 Protein charge	350
15.2.1 Modifying the layout	351
15.3 Transmembrane helix prediction	351
15.4 Antigenicity	351
15.4.1 Plot of antigenicity	352
15.4.2 Antigenicity graphs along sequence	352
15.5 Hydrophobicity	353
15.5.1 Hydrophobicity plot	353
15.5.2 Hydrophobicity graphs along sequence	353
15.5.3 Bioinformatics explained: Protein hydrophobicity	355
15.6 Pfam domain search	357
15.6.1 Download of Pfam database	358
15.6.2 Running Pfam Domain Search	358
15.7 Secondary structure prediction	360
15.8 Protein report	361
15.8.1 Protein report output	363
15.9 Reverse translation from protein into DNA	363
15.9.1 Reverse translation parameters	364
15.9.2 Bioinformatics explained: Reverse translation	365
15.10 Proteolytic cleavage detection	367
15.10.1 Proteolytic cleavage parameters	367
15.10.2 Bioinformatics explained: Proteolytic cleavage	369

CLC Genomics Workbench offers a number of analyses of proteins as described in this chapter.

15.1 Signal peptide prediction

For prediction of signal peptides, you need to download the SignalP plugin. The plugin will install the following tool:

Toolbox | Classical Sequence Analysis (📁) | Protein Analysis (📁) | Signal Peptide Prediction (🌿)

For more information, please read the plugin manual at http://resources.qiagenbioinformatics.com/manuals/signalP/current/SignalP_User_Manual.pdf

15.2 Protein charge

In *CLC Genomics Workbench* you can create a graph in the electric charge of a protein as a function of pH. This is particularly useful for finding the net charge of the protein at a given pH. This knowledge can be used e.g. in relation to isoelectric focusing on the first dimension of 2D-gel electrophoresis. The isoelectric point (pI) is found where the net charge of the protein is zero. The calculation of the protein charge does not include knowledge about any potential post-translational modifications the protein may have.

The pKa values reported in the literature may differ slightly, thus resulting in different looking graphs of the protein charge plot compared to other programs.

In order to calculate the protein charge:

Toolbox | Classical Sequence Analysis (📁) | Protein Analysis (📁) | Create Protein Charge Plot (📊)

This opens the dialog displayed in figure 15.1:

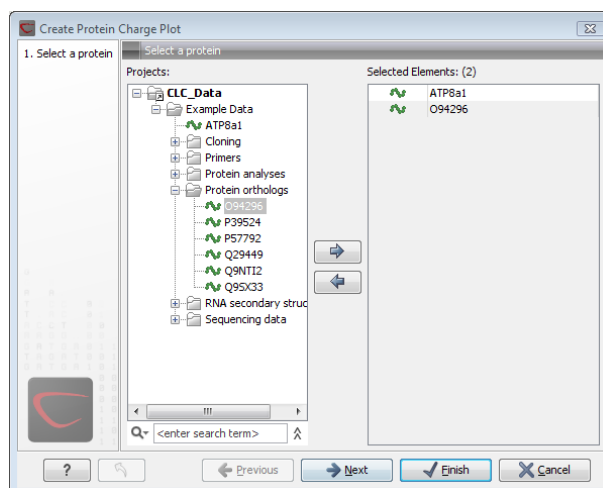

Figure 15.1: Choosing protein sequences to calculate protein charge.

If a sequence was selected before choosing the Toolbox action, the sequence is now listed in the **Selected Elements** window of the dialog. Use the arrows to add or remove sequences or sequence lists from the selected elements.

You can perform the analysis on several protein sequences at a time. This will result in one output graph showing protein charge graphs for the individual proteins.

Click **Next** if you wish to adjust how to handle the results (see section 8.2). If not, click **Finish**.

15.2.1 Modifying the layout

Figure 15.2 shows the electrical charges for three proteins. In the **Side Panel** to the right, you can modify the layout of the graph.

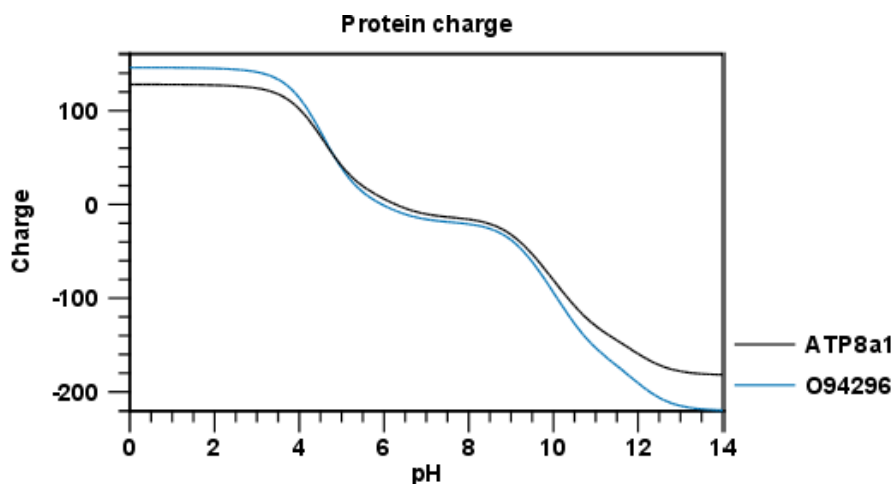

Figure 15.2: View of the protein charge.

See section B in the appendix for information about the graph view.

15.3 Transmembrane helix prediction

In order to use the transmembrane helix prediction, you need to download the plugin. The plugin will install the following tool:

Toolbox | Classical Sequence Analysis (📄) | Protein Analysis (📄) | Transmembrane Helix Prediction (📄)

For more information, please read the plugin manual at http://resources.qiagenbioinformatics.com/manuals/tmhmm/140/Tmhmm_User_Manual.pdf

15.4 Antigenicity

CLC Genomics Workbench can help to identify antigenic regions in protein sequences in different ways, using different algorithms. The algorithms provided in the Workbench, merely plot an index of antigenicity over the sequence.

Two different methods are available.

[Welling et al., 1985] Welling et al. used information on the relative occurrence of amino acids in antigenic regions to make a scale which is useful for prediction of antigenic regions. This method is better than the Hopp-Woods scale of hydrophobicity which is also used to identify antigenic regions.

A semi-empirical method for prediction of antigenic regions has been developed [Kolaskar and Tongaonkar, 1990]. This method also includes information of surface accessibility and flexibility

and at the time of publication the method was able to predict antigenic determinants with an accuracy of 75%.

Note! Similar results from the two methods can not always be expected as the two methods are based on different training sets.

15.4.1 Plot of antigenicity

Displaying the antigenicity for a protein sequence in a plot is done in the following way:

Toolbox | Classical Sequence Analysis (📁) | Protein Analysis (📁) | Create Antigenicity Plot (📊)

This opens a dialog. The first step allows you to add or remove sequences. If you had already selected sequences in the Navigation Area before running the Toolbox action, these are shown in the **Selected Elements**. Clicking **Next** takes you through to **Step 2**, which is displayed in figure 15.3.

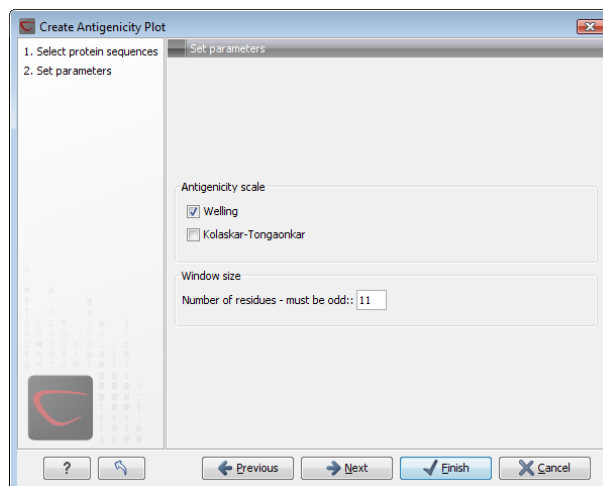

Figure 15.3: Step two in the Antigenicity Plot allows you to choose different antigenicity scales and the window size.

The **Window size** is the width of the window where, the antigenicity is calculated. The wider the window, the less volatile the graph. You can choose from a number of antigenicity scales. Click **Next** if you wish to adjust how to handle the results (see section 8.2). If not, click **Finish**. The result can be seen in figure 15.4.

See section B in the appendix for information about the graph view.

The level of antigenicity is calculated on the basis of the different scales. The different scales add different values to each type of amino acid. The antigenicity score is then calculated as the sum of the values in a 'window', which is a particular range of the sequence. The window length can be set from 5 to 25 residues. The wider the window, the less fluctuations in the antigenicity scores.

15.4.2 Antigenicity graphs along sequence

Antigenicity graphs along the sequence can be displayed using the **Side Panel**. The functionality

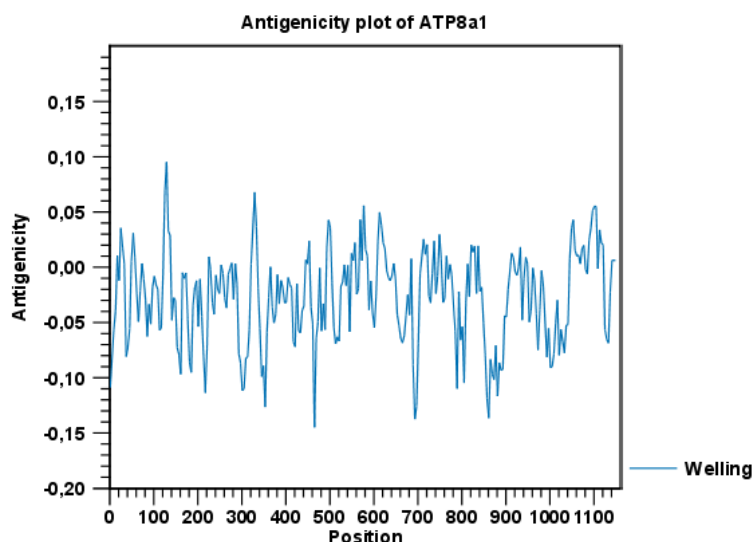

Figure 15.4: The result of the antigenicity plot calculation and the associated Side Panel.

is similar to hydrophobicity (see section 15.5.2).

15.5 Hydrophobicity

CLC Genomics Workbench can calculate the hydrophobicity of protein sequences in different ways, using different algorithms. (See section 15.5.3). Furthermore, hydrophobicity of sequences can be displayed as hydrophobicity plots and as graphs along sequences. In addition, CLC Genomics Workbench can calculate hydrophobicity for several sequences at the same time, and for alignments.

15.5.1 Hydrophobicity plot

Displaying the hydrophobicity for a protein sequence in a plot is done in the following way:

Toolbox | **Classical Sequence Analysis** (📁) | **Protein Analysis** (📁) | **Create Hydrophobicity Plot** (📊)

This opens a dialog. The first step allows you to add or remove sequences. If you had already selected a sequence in the Navigation Area, this will be shown in the **Selected Elements**. Clicking **Next** takes you through to **Step 2**, which is displayed in figure 15.5.

The **Window size** is the width of the window where the hydrophobicity is calculated. The wider the window, the less volatile the graph. You can choose from a number of hydrophobicity scales which are further explained in section 15.5.3. Click **Next** if you wish to adjust how to handle the results (see section 8.2). If not, click **Finish**. The result can be seen in figure 15.6.

See section B in the appendix for information about the graph view.

15.5.2 Hydrophobicity graphs along sequence

Hydrophobicity graphs along sequence can be displayed easily by activating the calculations from the **Side Panel** for a sequence.

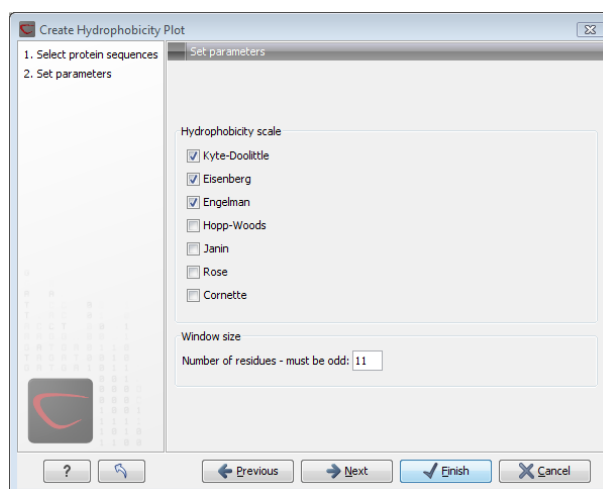

Figure 15.5: Step two in the Hydrophobicity Plot allows you to choose hydrophobicity scale and the window size.

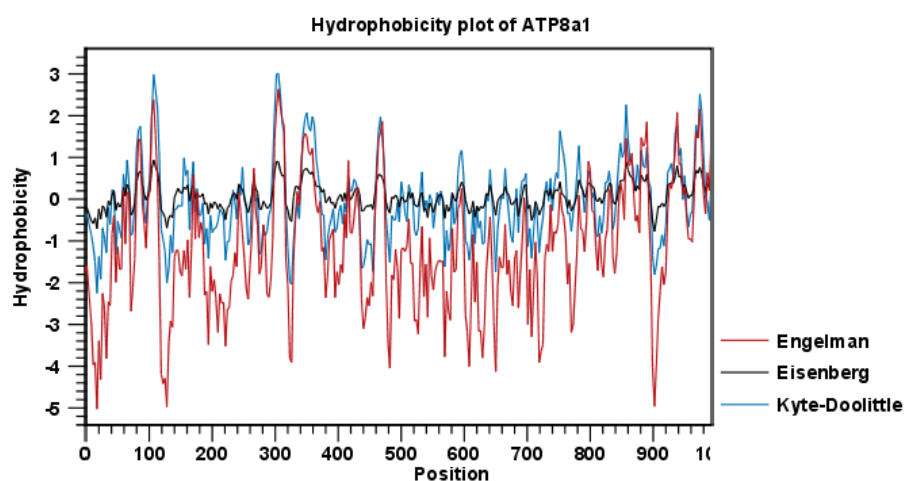

Figure 15.6: The result of the hydrophobicity plot calculation and the associated Side Panel.

right-click protein sequence in Navigation Area | Show | Sequence | open Protein info in Side Panel

or **double-click protein sequence in Navigation Area | Show | Sequence | open Protein info in Side Panel**

These actions result in the view displayed in figure 15.7.

The level of hydrophobicity is calculated on the basis of the different scales. The different scales add different values to each type of amino acid. The hydrophobicity score is then calculated as the sum of the values in a 'window', which is a particular range of the sequence. The window length can be set from 5 to 25 residues. The wider the window, the less fluctuations in the hydrophobicity scores. (For more about the theory behind hydrophobicity, see 15.5.3).

In the following we will focus on the different ways that *CLC Genomics Workbench* offers to display the hydrophobicity scores. We use Kyte-Doolittle to explain the display of the scores, but the different options are the same for all the scales. Initially there are three options for displaying the hydrophobicity scores. You can choose one, two or all three options by selecting the boxes. (See figure 15.8).



Figure 15.7: The different available scales in Protein info in **CLC Genomics Workbench**.



Figure 15.8: The different ways of displaying the hydrophobicity scores, using the Kyte-Doolittle scale.

Coloring the letters and their background. When choosing coloring of letters or coloring of their background, the color red is used to indicate high scores of hydrophobicity. A 'color-slider' allows you to amplify the scores, thereby emphasizing areas with high (or low, blue) levels of hydrophobicity. The color settings mentioned are default settings. By clicking the color bar just below the color slider you get the option of changing color settings.

Graphs along sequences. When selecting graphs, you choose to display the hydrophobicity scores underneath the sequence. This can be done either by a line-plot or bar-plot, or by coloring. The latter option offers you the same possibilities of amplifying the scores as applies for coloring of letters. The different ways to display the scores when choosing 'graphs' are displayed in figure 15.8. Notice that you can choose the height of the graphs underneath the sequence.

15.5.3 Bioinformatics explained: Protein hydrophobicity

Calculation of hydrophobicity is important to the identification of various protein features. This can be membrane spanning regions, antigenic sites, exposed loops or buried residues. Usually, these calculations are shown as a plot along the protein sequence, making it easy to identify the location of potential protein features.

The hydrophobicity is calculated by sliding a fixed size window (of an odd number) over the protein sequence. At the central position of the window, the average hydrophobicity of the entire window is plotted (see figure 15.9).

Hydrophobicity scales

Several hydrophobicity scales have been published for various uses. Many of the commonly used hydrophobicity scales are described below.

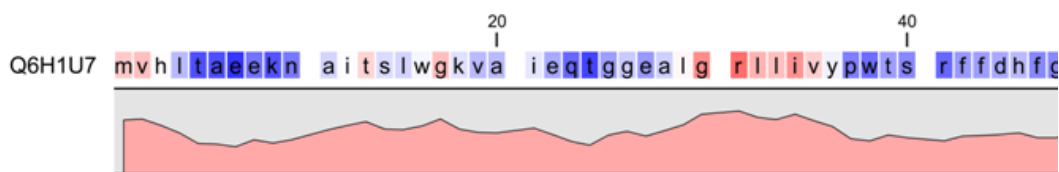

Figure 15.9: Plot of hydrophobicity along the amino acid sequence. Hydrophobic regions on the sequence have higher numbers according to the graph below the sequence, furthermore hydrophobic regions are colored on the sequence. Red indicates regions with high hydrophobicity and blue indicates regions with low hydrophobicity.

Kyte-Doolittle scale. The Kyte-Doolittle scale is widely used for detecting hydrophobic regions in proteins. Regions with a positive value are hydrophobic. This scale can be used for identifying both surface-exposed regions as well as transmembrane regions, depending on the window size used. Short window sizes of 5-7 generally work well for predicting putative surface-exposed regions. Large window sizes of 19-21 are well suited for finding transmembrane domains if the values calculated are above 1.6 [Kyte and Doolittle, 1982]. These values should be used as a rule of thumb and deviations from the rule may occur.

Engelman scale. The Engelman hydrophobicity scale, also known as the GES-scale, is another scale which can be used for prediction of protein hydrophobicity [Engelman et al., 1986]. As the Kyte-Doolittle scale, this scale is useful for predicting transmembrane regions in proteins.

Eisenberg scale. The Eisenberg scale is a normalized consensus hydrophobicity scale which shares many features with the other hydrophobicity scales [Eisenberg et al., 1984].

Hopp-Woods scale. Hopp and Woods developed their hydrophobicity scale for identification of potentially antigenic sites in proteins. This scale is basically a hydrophilic index where apolar residues have been assigned negative values. Antigenic sites are likely to be predicted when using a window size of 7 [Hopp and Woods, 1983].

Cornette scale. Cornette et al. computed an optimal hydrophobicity scale based on 28 published scales [Cornette et al., 1987]. This optimized scale is also suitable for prediction of alpha-helices in proteins.

Rose scale. The hydrophobicity scale by Rose et al. is correlated to the average area of buried amino acids in globular proteins [Rose et al., 1985]. This results in a scale which is not showing the helices of a protein, but rather the surface accessibility.

Janin scale. This scale also provides information about the accessible and buried amino acid residues of globular proteins [Janin, 1979].

Welling scale. Welling et al. used information on the relative occurrence of amino acids in antigenic regions to make a scale which is useful for prediction of antigenic regions. This method is better than the Hopp-Woods scale of hydrophobicity which is also used to identify antigenic regions.

Kolaskar-Tongaonkar. A semi-empirical method for prediction of antigenic regions has been developed [Kolaskar and Tongaonkar, 1990]. This method also includes information of surface accessibility and flexibility and at the time of publication the method was able to predict antigenic determinants with an accuracy of 75%.

aa	aa	Kyte-Doolittle	Hopp-Woods	Cornette	Eisenberg	Rose	Janin	Engelman (GES)
A	Alanine	1.80	-0.50	0.20	0.62	0.74	0.30	1.60
C	Cysteine	2.50	-1.00	4.10	0.29	0.91	0.90	2.00
D	Aspartic acid	-3.50	3.00	-3.10	-0.90	0.62	-0.60	-9.20
E	Glutamic acid	-3.50	3.00	-1.80	-0.74	0.62	-0.70	-8.20
F	Phenylalanine	2.80	-2.50	4.40	1.19	0.88	0.50	3.70
G	Glycine	-0.40	0.00	0.00	0.48	0.72	0.30	1.00
H	Histidine	-3.20	-0.50	0.50	-0.40	0.78	-0.10	-3.00
I	Isoleucine	4.50	-1.80	4.80	1.38	0.88	0.70	3.10
K	Lysine	-3.90	3.00	-3.10	-1.50	0.52	-1.80	-8.80
L	Leucine	3.80	-1.80	5.70	1.06	0.85	0.50	2.80
M	Methionine	1.90	-1.30	4.20	0.64	0.85	0.40	3.40
N	Asparagine	-3.50	0.20	-0.50	-0.78	0.63	-0.50	-4.80
P	Proline	-1.60	0.00	-2.20	0.12	0.64	-0.30	-0.20
Q	Glutamine	-3.50	0.20	-2.80	-0.85	0.62	-0.70	-4.10
R	Arginine	-4.50	3.00	1.40	-2.53	0.64	-1.40	-12.3
S	Serine	-0.80	0.30	-0.50	-0.18	0.66	-0.10	0.60
T	Threonine	-0.70	-0.40	-1.90	-0.05	0.70	-0.20	1.20
V	Valine	4.20	-1.50	4.70	1.08	0.86	0.60	2.60
W	Tryptophan	-0.90	-3.40	1.00	0.81	0.85	0.30	1.90
Y	Tyrosine	-1.30	-2.30	3.20	0.26	0.76	-0.40	-0.70

Table 15.1: *Hydrophobicity scales. This table shows seven different hydrophobicity scales which are generally used for prediction of e.g. transmembrane regions and antigenicity.*

Surface Probability. Display of surface probability based on the algorithm by [Emini et al., 1985]. This algorithm has been used to identify antigenic determinants on the surface of proteins.

Chain Flexibility. Display of backbone chain flexibility based on the algorithm by [Karplus and Schulz, 1985]. It is known that chain flexibility is an indication of a putative antigenic determinant.

Many more scales have been published throughout the last three decades. Even though more advanced methods have been developed for prediction of membrane spanning regions, the simple and very fast calculations are still highly used.

Other useful resources

AAindex: Amino acid index database

<http://www.genome.ad.jp/dbget/aaindex.html>

15.6 Pfam domain search

With *CLC Genomics Workbench* you can perform a search for domains in protein sequences using the Pfam database. The Pfam database [Bateman et al., 2004] at <http://pfam.sanger.ac.uk/> was initially developed to aid the annotation of the *C. elegans* genome. The database is a large collection of multiple sequence alignments that cover 14831 protein domains and protein families as of March 2014. The database contains profile hidden Markov models (HMMs) for individual domain alignments, which can be used to quickly identify domains in protein sequences.

Many proteins have a unique combination of domains, which can be responsible for e.g. the catalytic activities of enzymes. Annotating sequences based on pairwise alignment methods by simply transferring annotation from a known protein to the unknown partner does not take domain organization into account [Galperin and Koonin, 1998]. For example, a protein may be

annotated incorrectly as an enzyme if the pairwise alignment only finds a regulatory domain.

Using the **Pfam Domain Search** tool in *CLC Genomics Workbench*, you can search for domains in sequence data which otherwise do not carry any annotation information. The domain search is performed using the `hmmsearch` tool from the HMMER3 package version 3.1b1 (<http://hmmer.janelia.org/>). The Pfam search tool annotates protein sequences with all domains in the Pfam database that have a significant match. It is possible to lower the significance cutoff thresholds in the `hmmsearch` algorithm, which will reduce the number of domain annotations. Individual domain annotations can be removed manually as described in section 10.3.4.

15.6.1 Download of Pfam database

To be able to run the **Pfam Domain Search** tool you must first download the Pfam database. The Pfam database can be downloaded using:

Toolbox | Classical Sequence Analysis (📁) | Protein Analysis (📁) | Download Pfam Database (→)

Specify where you would like to save the downloaded Pfam database. The output of the **Download Pfam Database** tool is a database object, which can be selected as a parameter for the Pfam Domain Search tool. It doesn't really make sense to try to open the database object directly from the **Navigation Area** as all you can see directly is the element history (which version of the Workbench that has been used and the name of the downloaded files) and the element info, which in this case only provides information about the database name.

15.6.2 Running Pfam Domain Search

When you have downloaded the Pfam database you are ready to perform a Pfam domain search. To do this start the Pfam search tool:

Toolbox | Classical Sequence Analysis (📁) | Protein Analysis (📁) | Pfam Domain Search (→)

If a sequence was selected before choosing the Toolbox action, this sequence is now listed in the **Selected Elements** window of the dialog. Use the arrows to add or remove sequences or sequence lists from the selected elements.

You can perform the analysis on several protein sequences at a time. This will add annotations to all the sequences. Click **Next** to adjust parameters (see figure 15.10).

- **Database.** Choose which database to use when searching for Pfam domains. For information on how to download a Pfam database see section 15.6.1
- Significance cutoff
 - **Use profile's gathering cutoffs.** Use cutoffs specifically assigned to each family by the curator instead of manually assigning the **Significance cutoff**.
 - **Significance cutoff.** The E-value (expectation value) describes the number of hits one would expect to see by chance when searching a database of a particular size. Essentially, a hit with a low E-value is more significant compared to a hit with a high E-value. By lowering the significance threshold the domain search will become more

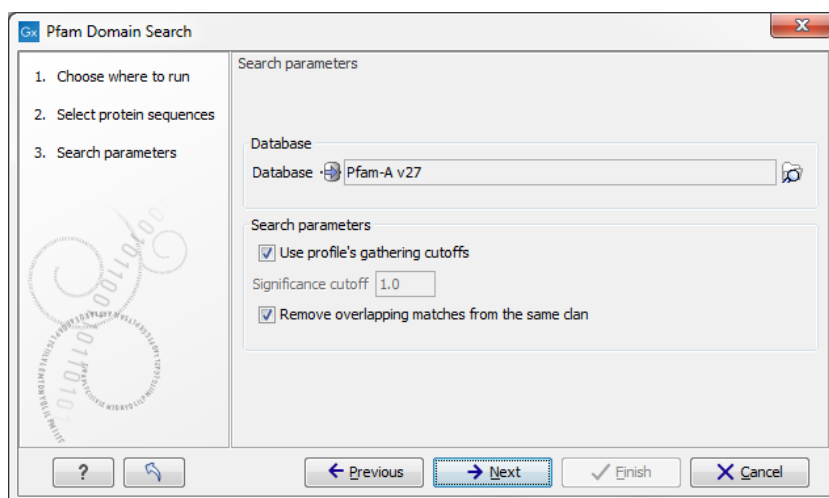

Figure 15.10: Setting parameters for Pfam Domain Search.

specific and less sensitive, i.e. fewer hits will be reported but the reported hits will be more significant on average.

- **Remove overlapping matches from the same clan.** Perform post-processing of the results where overlaps between hits are resolved by keeping the hit with the smallest e-value.

Click **Next** to adjust the output of the tool. The Pfam search tool can produce two types of output. It can add annotations on the input sequences that show the domains found (see figure 15.11) and it can output a table with all the domains found.

Click **Next** if you wish to adjust how to handle the results (see section 8.2). If not, click **Finish**.

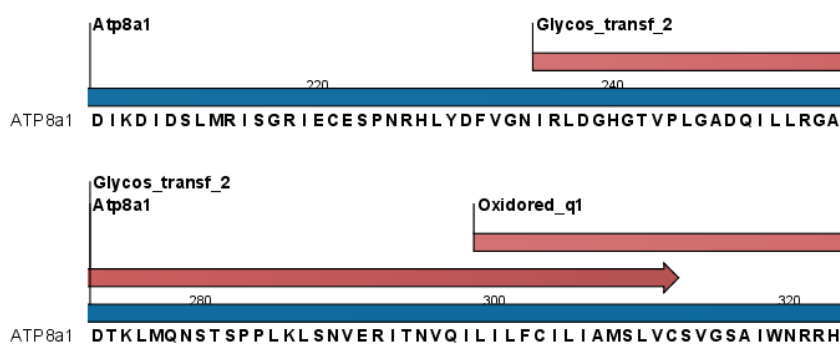

Figure 15.11: Annotations (in red) that were added by the Pfam search tool.

Domain annotations added by the Pfam search tool have the type **Region**. If the annotations are not visible they have to be enabled in the side panel. Detailed information for each domain annotation, such as the bit score which is the basis for the prediction of domains, is available through the annotation tool tip.

A more detailed description of the scores provided in the annotation tool tips can be found here: <http://pfam.sanger.ac.uk/help#tabview=tab5>.

15.7 Secondary structure prediction

An important issue when trying to understand protein function is to know the actual structure of the protein. Many questions that are raised by molecular biologists are directly targeted at protein structure. The alpha-helix forms a coiled rod like structure whereas a beta-sheet show an extended sheet-like structure. Some proteins are almost devoid of alpha-helices such as chymotrypsin (PDB_ID: 1AB9) whereas others like myoglobin (PDB_ID: 101M) have a very high content of alpha-helices.

With *CLC Genomics Workbench* one can predict the secondary structure of proteins very fast. Predicted elements are alpha-helix, beta-sheet (same as beta-strand) and other regions.

Based on extracted protein sequences from the protein databank (<http://www.rcsb.org/pdb/>) a hidden Markov model (HMM) was trained and evaluated for performance. Machine learning methods have shown superior when it comes to prediction of secondary structure of proteins [Rost, 2001]. By far the most common structures are Alpha-helices and beta-sheets which can be predicted, and predicted structures are automatically added to the query as annotation which later can be edited.

In order to predict the secondary structure of proteins:

Toolbox | Classical Sequence Analysis (📁) | Protein Analysis (📁) | Predict secondary structure (🔍)

This opens the dialog displayed in figure 15.12:

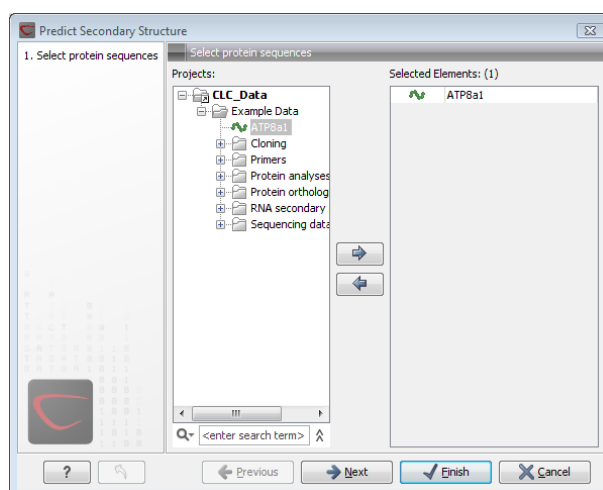

Figure 15.12: Choosing one or more protein sequences for secondary structure prediction.

If a sequence was selected before choosing the Toolbox action, this sequence is now listed in the **Selected Elements** window of the dialog. Use the arrows to add or remove sequences or sequence lists from the selected elements.

You can perform the analysis on several protein sequences at a time. This will add annotations to all the sequences and open a view for each sequence.

Click **Next** if you wish to adjust how to handle the results (see section 8.2). If not, click **Finish**.

After running the prediction as described above, the protein sequence will show predicted alpha-helices and beta-sheets as annotations on the original sequence (see figure 15.13).

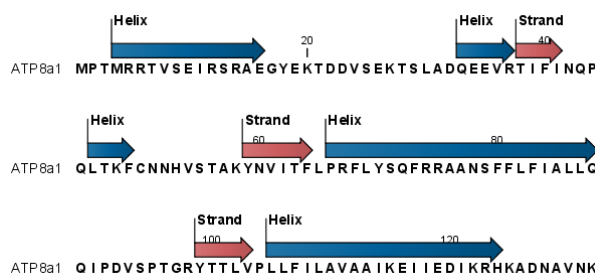

Figure 15.13: Alpha-helices and beta-strands shown as annotations on the sequence.

Each annotation will carry a tooltip note saying that the corresponding annotation is predicted with *CLC Genomics Workbench*. Additional notes can be added through the **Edit Annotation** (👉) right-click mouse menu. See section 10.3.2.

Undesired alpha-helices or beta-sheets can be removed through the **Delete Annotation** (🗑️) right-click mouse menu. See section 10.3.4.

15.8 Protein report

CLC Genomics Workbench is able to produce protein reports, that allow you to easily generate different kinds of information regarding a protein.

Actually a protein report is a collection of some of the protein analyses which are described elsewhere in this manual.

To create a protein report do the following:

Toolbox | **Classical Sequence Analysis** (📁) | **Protein Analysis** (📁) | **Create Protein Report** (📄)

This opens dialog **Step 1**, where you can choose which proteins to create a report for. If you had already selected a sequence in the Navigation Area before running the Toolbox action, this will be shown in the **Selected Elements**. However, you can use the arrows to change this. When the correct one is chosen, click **Next**.

In dialog **Step 2** you can choose which analyses you want to include in the report. The following list shows which analyses are available and explains where to find more details.

- **Sequence statistics.** See section 13.6 for more about this topic.
- **Plot of charge as function of pH.** See section 15.2 for more about this topic.
- **Plot of hydrophobicity.** See section 15.5 for more about this topic.
- **Plot of local complexity.** See section 13.5 for more about this topic.
- **Dot plot against self.** See section 13.4 for more about this topic.
- **Secondary structure prediction.** See section 15.7 for more about this topic.
- **Pfam domain search.** See section 15.6 for more about this topic.
- **Local BLAST.** See section 11.1.3 for more about this topic.

- **NCBI BLAST.** See section [11.1.1](#) for more about this topic.

When you have selected the relevant analyses, click **Next. Step 3 to Step 7** (if you select all the analyses in **Step 2**) are adjustments of parameters for the different analyses. The parameters are mentioned briefly in relation to the following steps, and you can turn to the relevant chapters or sections (mentioned above) to learn more about the significance of the parameters.

In **Step 3** you can adjust parameters for sequence statistics:

- **Individual Statistics Layout. Comparative** is disabled because reports are generated for one protein at a time.
- **Include Background Distribution of Amino Acids.** Includes distributions from different organisms. Background distributions are calculated from UniProt www.uniprot.org version 6.0, dated September 13 2005.

In **Step 4** you can adjust parameters for hydrophobicity plots:

- **Window size.** Width of window on sequence (odd number).
- **Hydrophobicity scales.** Lets you choose between different scales.

In **Step 5** you can adjust a parameter for complexity plots:

- **Window size.** Width of window on sequence (must be odd).

In **Step 6** you can adjust parameters for dot plots:

- **Score model.** Different scoring matrices.
- **Window size.** Width of window on sequence.

In **Step 7** you can adjust parameters for Pfam domain search:

- **Database and search type.** Lets you choose different databases and specify the search for full domains or fragments. See section [15.6.2](#) for more info about this topic.
- **Significance cutoff.** Lets you set your E-value. See section [15.6.2](#) for more info about this topic.

In **Step 8** you can adjust parameters for BLAST search:

- **Program.** Lets you choose between different BLAST programs.
- **Database.** Lets you limit your search to a particular database.

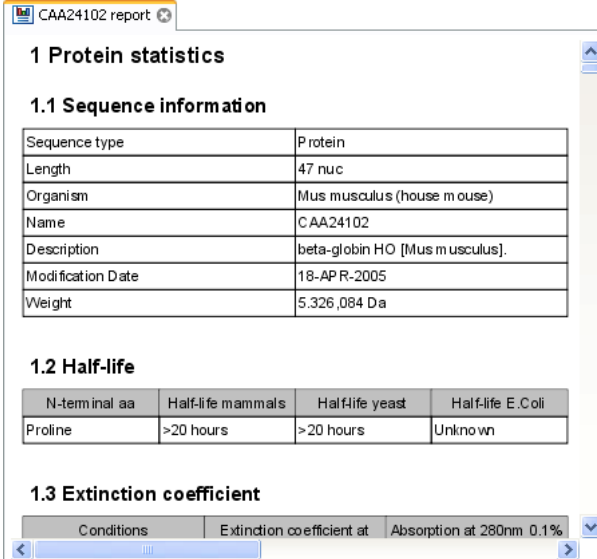

1 Protein statistics

1.1 Sequence information

Sequence type	Protein
Length	47 nuc
Organism	Mus musculus (house mouse)
Name	CAA24102
Description	beta-globin HO [Mus musculus]
Modification Date	18-APR-2005
Weight	5.326,084 Da

1.2 Half-life

N-terminal aa	Half-life mammals	Half-life yeast	Half-life E.Coli
Proline	>20 hours	>20 hours	Unknown

1.3 Extinction coefficient

Conditions	Extinction coefficient at	Absorption at 280nm 0.1%

Figure 15.14: A protein report. There is a Table of Contents in the Side Panel that makes it easy to browse the report.

15.8.1 Protein report output

An example of Protein report can be seen in figure 15.14.

By double clicking a graph in the output, this graph is shown in a different view (*CLC Genomics Workbench* generates another tab). The report output and the new graph views can be saved by dragging the tab into the **Navigation Area**.

The content of the tables in the report can be copy/pasted out of the program and e.g. into Microsoft Excel. To do so:

Select content of table | Right-click the selection | Copy

You can also **Export** (📄) the report in Excel format.

15.9 Reverse translation from protein into DNA

A protein sequence can be back-translated into DNA using *CLC Genomics Workbench*. Due to degeneracy of the genetic code every amino acid could translate into several different codons (only 20 amino acids but 64 different codons). Thus, the program offers a number of choices for determining which codons should be used. These choices are explained in this section. For background information see section 15.9.2.

In order to make a reverse translation:

Toolbox | **Classical Sequence Analysis** (📄) | **Protein Analysis** (📄) | **Reverse Translate** (📄)

This opens the dialog displayed in figure 15.15:

If a sequence was selected before choosing the Toolbox action, the sequence is now listed in the **Selected Elements** window of the dialog. Use the arrows to add or remove sequences or sequence lists from the selected elements. You can translate several protein sequences at a time.

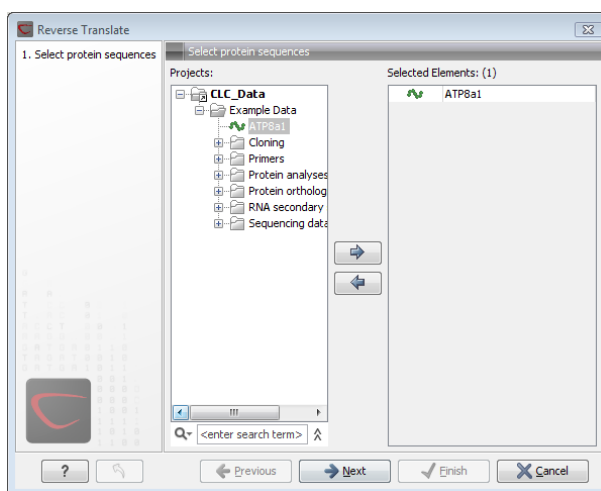

Figure 15.15: Choosing a protein sequence for reverse translation.

Click **Next** to adjust the parameters for the translation.

15.9.1 Reverse translation parameters

Figure 15.16 shows the choices for making the translation.

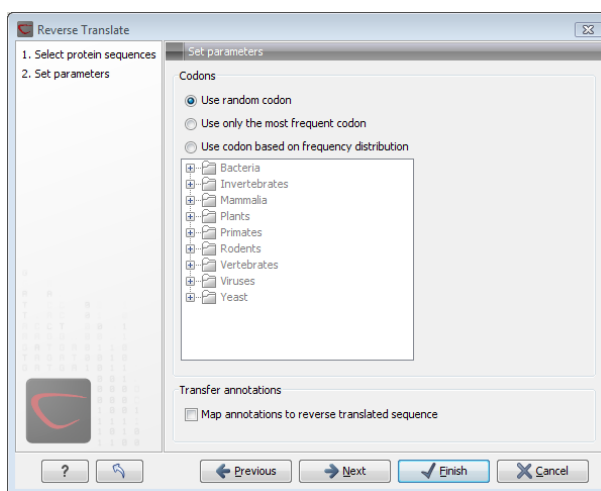

Figure 15.16: Choosing parameters for the reverse translation.

- **Use random codon.** This will randomly back-translate an amino acid to a codon assuming the genetic code to be 1, but without using the codon frequency tables. Every time you perform the analysis you will get a different result.
- **Use only the most frequent codon.** On the basis of the selected translation table, this parameter/option will assign the codon that occurs most often. When choosing this option, the results of performing several reverse translations will always be the same, contrary to the other two options.
- **Use codon based on frequency distribution.** This option is a mix of the other two options. The selected translation table is used to attach weights to each codon based on its frequency. The codons are assigned randomly with a probability given by the weights. A

more frequent codon has a higher probability of being selected. Every time you perform the analysis, you will get a different result. This option yields a result that is closer to the translation behavior of the organism (assuming you choose an appropriate codon frequency table).

- **Map annotations to reverse translated sequence.** If this checkbox is checked, then all annotations on the protein sequence will be mapped to the resulting DNA sequence. In the tooltip on the transferred annotations, there is a note saying that the annotation derives from the original sequence.

The **Codon Frequency Table** is used to determine the frequencies of the codons. Select a frequency table from the list that fits the organism you are working with. A translation table of an organism is created on the basis of counting all the codons in the coding sequences. Every codon in a **Codon Frequency Table** has its own count, frequency (per thousand) and fraction which are calculated in accordance with the occurrences of the codon in the organism. The tables provided were made using Codon Usage database <http://www.kazusa.or.jp/codon/> that was built on The NCBI-GenBank Flat File Release 160.0 [June 15 2007]. You can customize the list of codon frequency tables for your installation, see Appendix L.

Click **Next** if you wish to adjust how to handle the results (see section 8.2). If not, click **Finish**. The newly created nucleotide sequence is shown, and if the analysis was performed on several protein sequences, there will be a corresponding number of views of nucleotide sequences. The new sequence is not saved automatically. To save the sequence, drag it into the **Navigation Area** or press Ctrl + S (⌘ + S on Mac) to show the save dialog.

15.9.2 Bioinformatics explained: Reverse translation

In all living cells containing hereditary material such as DNA, a transcription to mRNA and subsequent a translation to proteins occur. This is of course simplified but is in general what is happening in order to have a steady production of proteins needed for the survival of the cell. In bioinformatics analysis of proteins it is sometimes useful to know the ancestral DNA sequence in order to find the genomic localization of the gene. Thus, the translation of proteins back to DNA/RNA is of particular interest, and is called reverse translation or back-translation.

The Genetic Code

In 1968 the Nobel Prize in Medicine was awarded to Robert W. Holley, Har Gobind Khorana and Marshall W. Nirenberg for their interpretation of the Genetic Code (<http://nobelprize.org/medicine/laureates/1968/>). The Genetic Code represents translations of all 64 different codons into 20 different amino acids. Therefore it is no problem to translate a DNA/RNA sequence into a specific protein. But due to the degeneracy of the genetic code, several codons may code for only one specific amino acid. This can be seen in the table below. After the discovery of the genetic code it has been concluded that different organism (and organelles) have genetic codes which are different from the "standard genetic code". Moreover, the amino acid alphabet is no longer limited to 20 amino acids. The 21st amino acid, selenocysteine, is encoded by an 'UGA' codon which is normally a stop codon. The discrimination of a selenocysteine over a stop codon is carried out by the translation machinery. Selenocysteines are very rare amino acids.

The table below shows the Standard Genetic Code which is the default translation table.

TTT F Phe	TCT S Ser	TAT Y Tyr	TGT C Cys
TTC F Phe	TCC S Ser	TAC Y Tyr	TGC C Cys
TTA L Leu	TCA S Ser	TAA * Ter	TGA * Ter
TTG L Leu i	TCG S Ser	TAG * Ter	TGG W Trp
CTT L Leu	CCT P Pro	CAT H His	CGT R Arg
CTC L Leu	CCC P Pro	CAC H His	CGC R Arg
CTA L Leu	CCA P Pro	CAA Q Gln	CGA R Arg
CTG L Leu i	CCG P Pro	CAG Q Gln	CGG R Arg
ATT I Ile	ACT T Thr	AAT N Asn	AGT S Ser
ATC I Ile	ACC T Thr	AAC N Asn	AGC S Ser
ATA I Ile	ACA T Thr	AAA K Lys	AGA R Arg
ATG M Met i	ACG T Thr	AAG K Lys	AGG R Arg
GTT V Val	GCT A Ala	GAT D Asp	GGT G Gly
GTC V Val	GCC A Ala	GAC D Asp	GGC G Gly
GTA V Val	GCA A Ala	GAA E Glu	GGA G Gly
GTG V Val	GCG A Ala	GAG E Glu	GGG G Gly

Solving the ambiguities of reverse translation

A particular protein follows from the translation of a DNA sequence whereas the reverse translation need not have a specific solution according to the Genetic Code. The Genetic Code is degenerate which means that a particular amino acid can be translated into more than one codon. Hence there are ambiguities of the reverse translation.

In order to solve these ambiguities of reverse translation you can define how to prioritize the codon selection, e.g:

- Choose a codon randomly.
- Select the most frequent codon in a given organism.
- Randomize a codon, but with respect to its frequency in the organism.

As an example we want to translate an alanine to the corresponding codon. Four different codons can be used for this reverse translation; GCU, GCC, GCA or GCG. By picking either one by random choice we will get an alanine.

The most frequent codon, coding for an alanine in *E. coli* is GCG, encoding 33.7% of all alanines. Then comes GCC (25.5%), GCA (20.3%) and finally GCU (15.3%). The data are retrieved from the Codon usage database, see below. Always picking the most frequent codon does not necessarily give the best answer.

By selecting codons from a distribution of calculated codon frequencies, the DNA sequence obtained after the reverse translation, holds the correct (or nearly correct) codon distribution. It should be kept in mind that the obtained DNA sequence is not necessarily identical to the original one encoding the protein in the first place, due to the degeneracy of the genetic code.

In order to obtain the best possible result of the reverse translation, one should use the codon frequency table from the correct organism or a closely related species. The codon usage of the

mitochondrial chromosome are often different from the native chromosome(s), thus mitochondrial codon frequency tables should only be used when working specifically with mitochondria.

Other useful resources

The Genetic Code at NCBI:

<http://www.ncbi.nlm.nih.gov/Taxonomy/Utils/wprintgc.cgi?mode=c>

Codon usage database:

<http://www.kazusa.or.jp/codon/>

Wikipedia on the genetic code

http://en.wikipedia.org/wiki/Genetic_code

15.10 Proteolytic cleavage detection

CLC Genomics Workbench offers to analyze protein sequences with respect to cleavage by a selection of proteolytic enzymes. This section explains how to adjust the detection parameters and offers basic information on proteolytic cleavage in general.

15.10.1 Proteolytic cleavage parameters

Given a protein sequence, *CLC Genomics Workbench* detects proteolytic cleavage sites in accordance with detection parameters and shows the detected sites as annotations on the sequence and in textual format in a table below the sequence view.

Detection of proteolytic cleavage sites is initiated by:

Toolbox | Classical Sequence Analysis (📁) | Protein Analysis (📁) | Proteolytic Cleavage, (✂️)

This opens the dialog shown in figure 15.17:

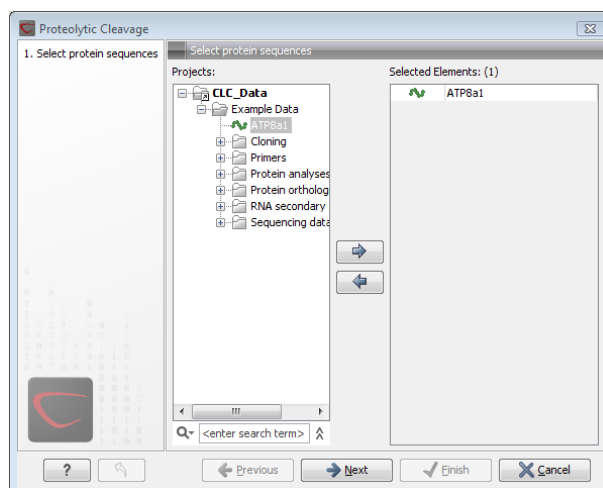

Figure 15.17: Choosing sequence CAA32220 for proteolytic cleavage.

CLC Genomics Workbench allows you to detect proteolytic cleavages for several sequences at a time. Correct the list of sequences by selecting a sequence and clicking the arrows pointing left and right. Then click **Next** to go to **Step 2**.

In **Step 2** you can select proteolytic cleavage enzymes. The list of available enzymes will be expanded continuously. Presently, the list contains the enzymes shown in figure 15.18. The full list of enzymes and their cleavage patterns can be seen in Appendix, section D.

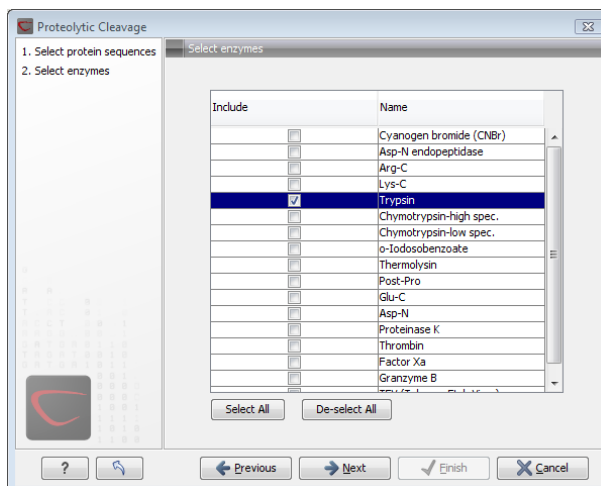

Figure 15.18: Setting parameters for proteolytic cleavage detection.

Select the enzymes you want to use for detection. When the relevant enzymes are chosen, click **Next**.

In **Step 3** you can set parameters for the detection. This limits the number of detected cleavages. Figure 15.19 shows an example of how parameters can be set.

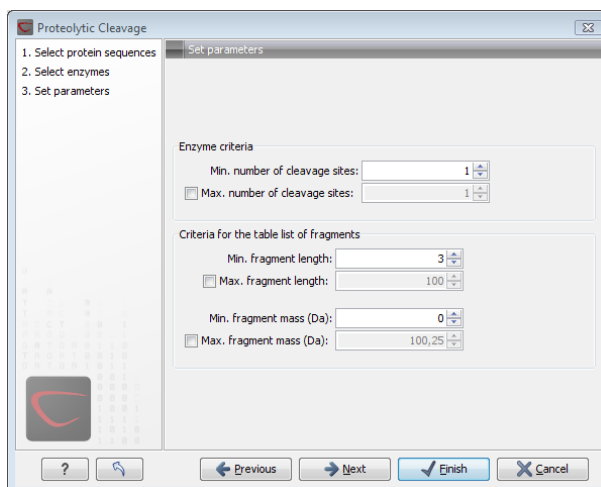

Figure 15.19: Setting parameters for proteolytic cleavage detection.

- **Min. and max. number of cleavage sites.** Certain proteolytic enzymes cleave at many positions in the amino acid sequence. For instance proteinase K cleaves at nine different amino acids, regardless of the surrounding residues. Thus, it can be very useful to limit the number of actual cleavage sites before running the analysis.
- **Min. and max. fragment length** Likewise, it is possible to limit the output to only display sequence fragments between a chosen length. Both a lower and upper limit can be chosen.

- **Min. and max. fragment mass** The molecular weight is not necessarily directly correlated to the fragment length as amino acids have different molecular masses. For that reason it is also possible to limit the search for proteolytic cleavage sites to mass-range.

Example!: If you have one protein sequence but you only want to show which enzymes cut between two and four times. Then you should select "The enzymes has more cleavage sites than 2" and select "The enzyme has less cleavage sites than 4". In the next step you should simply select all enzymes. This will result in a view where only enzymes which cut 2,3 or 4 times are presented.

Click **Next** if you wish to adjust how to handle the results (see section 8.2). If not, click **Finish**.

The result of the detection is displayed in figure 15.20.

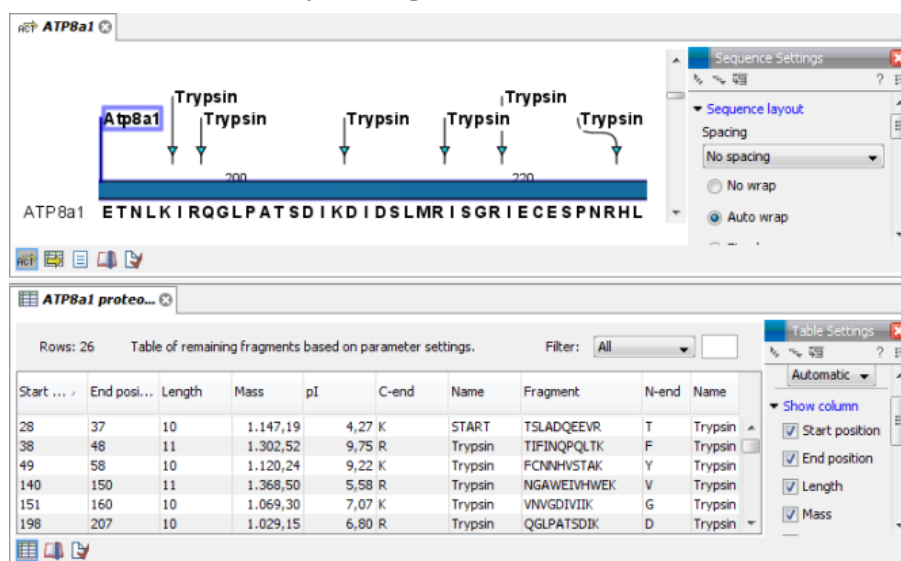

Figure 15.20: The result of the proteolytic cleavage detection.

Depending on the settings in the program, the output of the proteolytic cleavage site detection will display two views on the screen. The top view shows the actual protein sequence with the predicted cleavage sites indicated by small arrows. If no labels are found on the arrows they can be enabled by setting the labels in the "annotation layout" in the preference panel. The bottom view shows a text output of the detection, listing the individual fragments and information on these.

15.10.2 Bioinformatics explained: Proteolytic cleavage

Proteolytic cleavage is basically the process of breaking the peptide bonds between amino acids in proteins. This process is carried out by enzymes called peptidases, proteases or proteolytic cleavage enzymes.

Proteins often undergo proteolytic processing by specific proteolytic enzymes (proteases/peptidases) before final maturation of the protein. Proteins can also be cleaved as a result of intracellular processing of, for example, misfolded proteins. Another example of proteolytic processing of proteins is secretory proteins or proteins targeted to organelles, which have their signal peptide removed by specific signal peptidases before release to the extracellular environment or specific organelle.

Below a few processes are listed where proteolytic enzymes act on a protein substrate.

- N-terminal methionine residues are often removed after translation.
- Signal peptides or targeting sequences are removed during translocation through a membrane.
- Viral proteins that were translated from a monocistronic mRNA are cleaved.
- Proteins or peptides can be cleaved and used as nutrients.
- Precursor proteins are often processed to yield the mature protein.

Proteolytic cleavage of proteins has shown its importance in laboratory experiments where it is often useful to work with specific peptide fragments instead of entire proteins.

Proteases also have commercial applications. As an example proteases can be used as detergents for cleavage of proteinaceous stains in clothing.

The general nomenclature of cleavage site positions of the substrate were formulated by Schechter and Berger, 1967-68 [Schechter and Berger, 1967], [Schechter and Berger, 1968]. They designate the cleavage site between P1-P1', incrementing the numbering in the N-terminal direction of the cleaved peptide bond (P2, P3, P4, etc..). On the carboxyl side of the cleavage site the numbering is incremented in the same way (P1', P2', P3' etc.). This is visualized in figure 15.21.

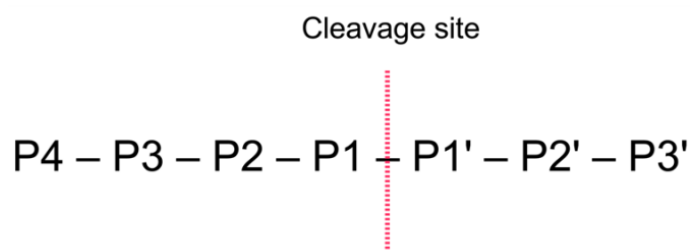

Figure 15.21: *Nomenclature of the peptide substrate. The substrate is cleaved between position P1-P1'.*

Proteases often have a specific recognition site where the peptide bond is cleaved. As an example trypsin only cleaves at lysine or arginine residues, but it does not matter (with a few exceptions) which amino acid is located at position P1'(carboxyterminal of the cleavage site). Another example is trombin which cleaves if an arginine is found in position P1, but not if a D or E is found in position P1' at the same time. (See figure 15.22).

Bioinformatics approaches are used to identify potential peptidase cleavage sites. Fragments can be found by scanning the amino acid sequence for patterns which match the corresponding cleavage site for the protease. When identifying cleaved fragments it is relatively important to know the calculated molecular weight and the isoelectric point.

Other useful resources

The Peptidase Database: <http://merops.sanger.ac.uk/>

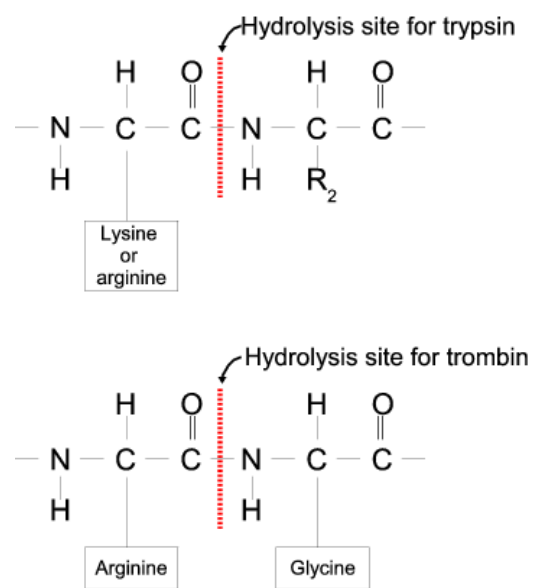

Figure 15.22: Hydrolysis of the peptide bond between two amino acids. Trypsin cleaves unspecifically at lysine or arginine residues whereas trombin cleaves at arginines if aspartate or glutamate is absent.

Chapter 16

Primers

Contents

16.1 Primer design - an introduction	373
16.1.1 General concept	373
16.1.2 Scoring primers	375
16.2 Setting parameters for primers and probes	375
16.2.1 Primer Parameters	376
16.3 Graphical display of primer information	378
16.3.1 Compact information mode	378
16.3.2 Detailed information mode	379
16.4 Output from primer design	380
16.4.1 Saving primers	380
16.4.2 Saving PCR fragments	380
16.4.3 Adding primer binding annotation	380
16.5 Standard PCR	381
16.5.1 User input	381
16.5.2 Standard PCR output table	383
16.6 Nested PCR	384
16.6.1 Nested PCR output table	386
16.7 TaqMan	386
16.7.1 TaqMan output table	388
16.8 Sequencing primers	388
16.8.1 Sequencing primers output table	388
16.9 Alignment-based primer and probe design	388
16.9.1 Specific options for alignment-based primer and probe design	389
16.9.2 Alignment based design of PCR primers	390
16.9.3 Alignment-based TaqMan probe design	392
16.10 Analyze primer properties	394
16.11 Find binding sites and create fragments	395
16.11.1 Binding parameters	396
16.11.2 Results - binding sites and fragments	397
16.12 Order primers	399

CLC Genomics Workbench offers graphically and algorithmically advanced design of primers and probes for various purposes. This chapter begins with a brief introduction to the general concepts of the primer designing process. Then follows instructions on how to adjust parameters for primers, how to inspect and interpret primer properties graphically and how to interpret, save and analyze the output of the primer design analysis. After a description of the different reaction types for which primers can be designed, the chapter closes with sections on how to match primers with other sequences and how to create a primer order.

16.1 Primer design - an introduction

Primer design can be accessed in two ways:

Toolbox | Molecular Biology Tools (🔧) | Primers and Probes (📄) | Design Primers (🔍) | OK

or **right-click sequence in Navigation Area | Show | Primer (🔍)**

In the primer view (see figure 16.1), the basic options for viewing the template sequence are the same as for the standard sequence view. See section 10.1 for an explanation of these options.

Note! This means that annotations such as e.g. known SNPs or exons, can be displayed on the template sequence to guide the choice of primer regions. Also, traces in sequencing reads can be shown along with the structure to guide e.g. the re-sequencing of poorly resolved regions.

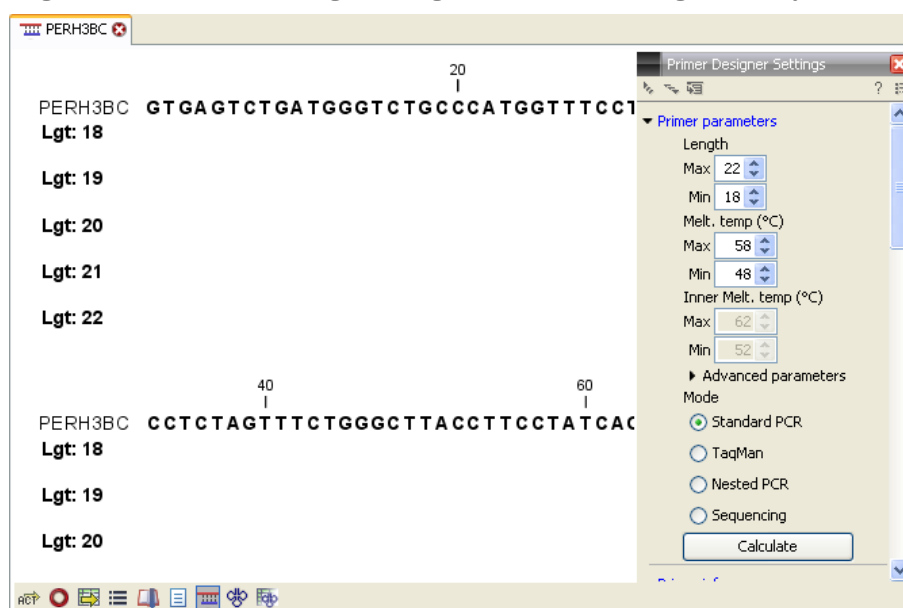

Figure 16.1: The initial view of the sequence used for primer design.

16.1.1 General concept

The concept of the primer view is that the user first chooses the desired reaction type for the session in the Primer Parameters preference group, e.g. *Standard PCR*. Reflecting the choice of reaction type, it is now possible to select one or more regions on the sequence and to use the right-click mouse menu to designate these as primer or probe regions (see figure 16.2).

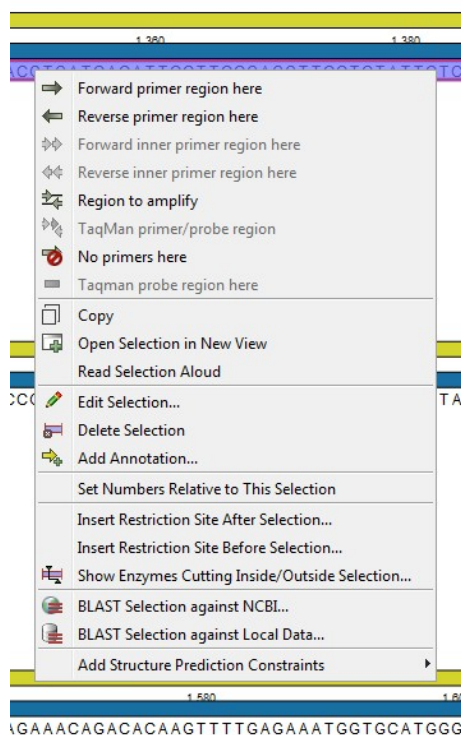

Figure 16.2: Right-click menu allowing you to specify regions for the primer design

When a region is chosen, graphical information about the properties of all possible primers in this region will appear in lines beneath it. By default, information is showed using a compact mode but the user can change to a more detailed mode in the Primer information preference group.

The number of information lines reflects the chosen length interval for primers and probes. In the compact information mode one line is shown for every possible primer-length and each of these lines contain information regarding all possible primers of the given length. At each potential primer starting position, a circular information point is shown which indicates whether the primer fulfills the requirements set in the primer parameters preference group. A green circle indicates a primer which fulfills all criteria and a red circle indicates a primer which fails to meet one or more of the set criteria. For more detailed information, place the mouse cursor over the circle representing the primer of interest. A tool-tip will then appear on screen, displaying detailed information about the primer in relation to the set criteria. To locate the primer on the sequence, simply left-click the circle using the mouse.

The various primer parameters can now be varied to explore their effect and the view area will dynamically update to reflect this allowing for a high degree of interactivity in the primer design process.

After having explored the potential primers the user may have found a satisfactory primer and choose to export this directly from the view area using a mouse right-click on the primers information point. This does not allow for any design information to enter concerning the properties of primer/probe pairs or sets e.g. primer pair annealing and T_m difference between primers. If the latter is desired the user can use the **Calculate** button at the bottom of the Primer parameter preference group. This will activate a dialog, the contents of which depends on the chosen mode. Here, the user can set primer-pair specific setting such as allowed or desired T_m

difference and view the single-primer parameters which were chosen in the Primer parameters preference group.

Upon pressing finish, an algorithm will generate all possible primer sets and rank these based on their characteristics and the chosen parameters. A list will appear displaying the 100 most high scoring sets and information pertaining to these. The search result can be saved to the navigator. From the result table, suggested primers or primer/probe sets can be explored since clicking an entry in the table will highlight the associated primers and probes on the sequence. It is also possible to save individual primers or sets from the table through the mouse right-click menu. For a given primer pair, the amplified PCR fragment can also be opened or saved using the mouse right-click menu.

16.1.2 Scoring primers

CLC Genomics Workbench employs a proprietary algorithm to rank primer and probe solutions. The algorithm considers both the parameters pertaining to single oligos, such as e.g. the secondary structure score and parameters pertaining to oligo-pairs such as e.g. the oligo pair-annealing score. The ideal score for a solution is 100 and solutions are thus ranked in descending order. Each parameter is assigned an ideal value and a tolerance. Consider for example oligo self-annealing, here the ideal value of the annealing score is 0 and the tolerance corresponds to the maximum value specified in the side panel. The contribution to the final score is determined by how much the parameter deviates from the ideal value and is scaled by the specified tolerance. Hence, a large deviation from the ideal and a small tolerance will give a large deduction in the final score and a small deviation from the ideal and a high tolerance will give a small deduction in the final score.

16.2 Setting parameters for primers and probes

The primer-specific view options and settings are found in the **Primer parameters** preference group in the **Side Panel** to the right of the view (see figure 16.3).

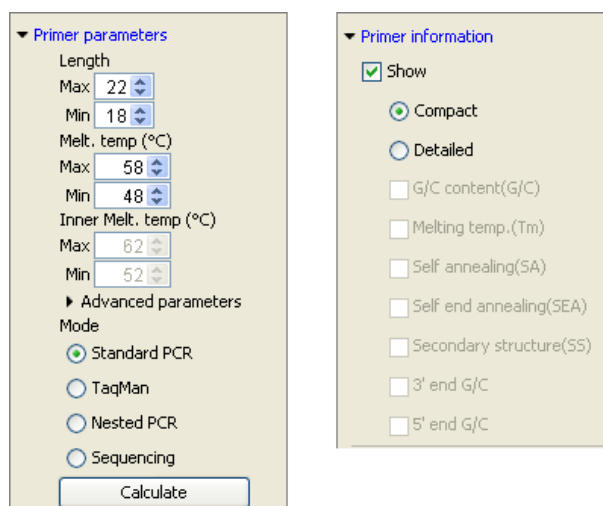

Figure 16.3: The two groups of primer parameters (in the program, the Primer information group is listed below the other group).

16.2.1 Primer Parameters

In this preference group a number of criteria can be set, which the selected primers must meet. All the criteria concern *single primers*, as primer pairs are not generated until the **Calculate** button is pressed. Parameters regarding primer and probe sets are described in detail for each reaction mode (see below).

- **Length.** Determines the length interval within which primers can be designed by setting a maximum and a minimum length. The upper and lower lengths allowed by the program are 50 and 10 nucleotides respectively.
- **Melting temperature.** Determines the temperature interval within which primers must lie. When the *Nested PCR* or *TaqMan* reaction type is chosen, the first pair of melting temperature interval settings relate to the outer primer pair i.e. not the probe. Melting temperatures are calculated by a nearest-neighbor model which considers stacking interactions between neighboring bases in the primer-template complex. The model uses state-of-the-art thermodynamic parameters [SantaLucia, 1998] and considers the important contribution from the dangling ends that are present when a short primer anneals to a template sequence [Bommarito et al., 2000]. A number of parameters can be adjusted concerning the reaction mixture and which influence melting temperatures (see below). Melting temperatures are corrected for the presence of monovalent cations using the model of [SantaLucia, 1998] and temperatures are further corrected for the presence of magnesium, deoxynucleotide triphosphates (dNTP) and dimethyl sulfoxide (DMSO) using the model of [von Ahsen et al., 2001].
- **Inner melting temperature.** This option is only activated when the *Nested PCR* or *TaqMan* mode is selected. In *Nested PCR* mode, it determines the allowed melting temperature interval for the inner/nested pair of primers, and in *TaqMan* mode it determines the allowed temperature interval for the TaqMan probe.
- **Advanced parameters.** A number of less commonly used options
 - **Buffer properties.** A number of parameters concerning the reaction mixture which influence melting temperatures.
 - * **Primer concentration.** Specifies the concentration of primers and probes in units of nanomoles (nM). Note that in the case of a mix of primers, the concentration here refers to the individual primer and not the combined primers concentration.
 - * **Salt concentration.** Specifies the concentration of monovalent cations ($[NA^+]$, $[K^+]$ and equivalents) in units of millimoles (mM)
 - * **Magnesium concentration.** Specifies the concentration of magnesium cations ($[Mg^{++}]$) in units of millimoles (mM)
 - * **dNTP concentration.** Specifies the combined concentration of all deoxynucleotide triphosphates in units of millimoles (mM)
 - * **DMSO concentration.** Specifies the concentration of dimethyl sulfoxide in units of volume percent ($vol.\%$)
 - **GC content.** Determines the interval of GC content (% C and G nucleotides in the primer) within which primers must lie by setting a maximum and a minimum GC content.

- **Self annealing.** Determines the maximum self annealing value of all primers and probes. This determines the amount of base-pairing allowed between two copies of the same molecule. The self annealing score is measured in number of hydrogen bonds between two copies of primer molecules, with A-T base pairs contributing 2 hydrogen bonds and G-C base pairs contributing 3 hydrogen bonds.
- **Self end annealing.** Determines the maximum self end annealing value of all primers and probes. This determines the number of consecutive base pairs allowed between the 3' end of one primer and another copy of that primer. This score is calculated in number of hydrogen bonds (the example below has a score of 4 - derived from 2 A-T base pairs each with 2 hydrogen bonds).

```
AATTCCCTACAATCCCCAAA
      | |
      AAACCCCTAACATCCCTTAA
```

- **Secondary structure.** Determines the maximum score of the optimal secondary DNA structure found for a primer or probe. Secondary structures are scored by the number of hydrogen bonds in the structure, and 2 extra hydrogen bonds are added for each stacking base-pair in the structure.
- **3' end G/C restrictions.** When this checkbox is selected it is possible to specify restrictions concerning the number of G and C molecules in the 3' end of primers and probes. A low G/C content of the primer/probe 3' end increases the specificity of the reaction. A high G/C content facilitates a tight binding of the oligo to the template but also increases the possibility of mispriming. Unfolding the preference groups yields the following options:
 - **End length.** The number of consecutive terminal nucleotides for which to consider the C/G content
 - **Max no. of G/C.** The maximum number of G and C nucleotides allowed within the specified length interval
 - **Min no. of G/C.** The minimum number of G and C nucleotides required within the specified length interval
- **5' end G/C restrictions.** When this checkbox is selected it is possible to specify restrictions concerning the number of G and C molecules in the 5' end of primers and probes. A high G/C content facilitates a tight binding of the oligo to the template but also increases the possibility of mis-priming. Unfolding the preference groups yields the same options as described above for the 3' end.
- **Mode.** Specifies the reaction type for which primers are designed:
 - **Standard PCR.** Used when the objective is to design primers, or primer pairs, for PCR amplification of a single DNA fragment.
 - **Nested PCR.** Used when the objective is to design two primer pairs for nested PCR amplification of a single DNA fragment.
 - **Sequencing.** Used when the objective is to design primers for DNA sequencing.
 - **TaqMan.** Used when the objective is to design a primer pair and a probe for TaqMan quantitative PCR.

Each mode is described further below.

- **Calculate.** Pushing this button will activate the algorithm for designing primers

16.3 Graphical display of primer information

The primer information settings are found in the **Primer information** preference group in the **Side Panel** to the right of the view (see figure 16.3).

There are two different ways to display the information relating to a single primer, the detailed and the compact view. Both are shown below the primer regions selected on the sequence.

16.3.1 Compact information mode

This mode offers a condensed overview of all the primers that are available in the selected region. When a region is chosen primer information will appear in lines beneath it (see figure 16.4).

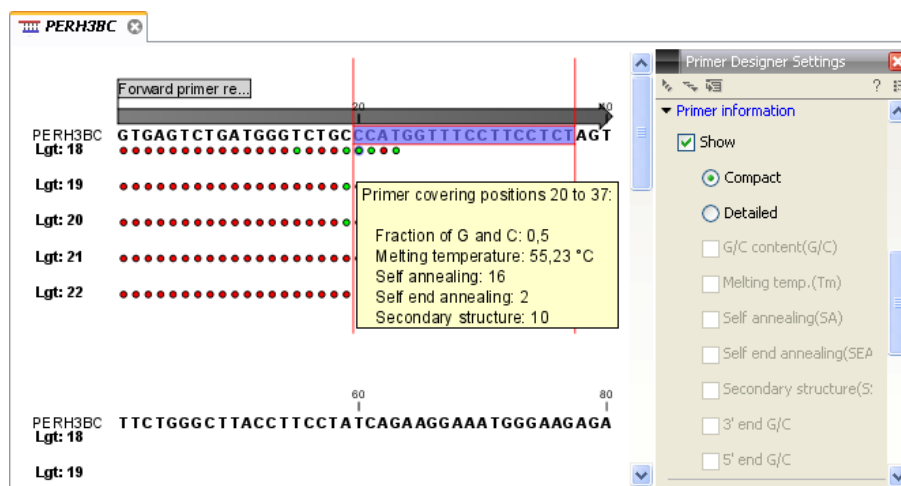

Figure 16.4: Compact information mode

The number of information lines reflects the chosen length interval for primers and probes. One line is shown for every possible primer-length, if the length interval is widened more lines will appear. At each potential primer starting position a circle is shown which indicates whether the primer fulfills the requirements set in the primer parameters preference group. A green primer indicates a primer which fulfills all criteria and a red primer indicates a primer which fails to meet one or more of the set criteria. For more detailed information, place the mouse cursor over the circle representing the primer of interest. A tool-tip will then appear on screen displaying detailed information about the primer in relation to the set criteria. To locate the primer on the sequence, simply left-click the circle using the mouse.

The various primer parameters can now be varied to explore their effect and the view area will dynamically update to reflect this. If e.g. the allowed melting temperature interval is widened more green circles will appear indicating that more primers now fulfill the set requirements and if e.g. a requirement for 3' G/C content is selected, red circles will appear at the starting points of the primers which fail to meet this requirement.

16.3.2 Detailed information mode

In this mode a very detailed account is given of the properties of all the available primers. When a region is chosen primer information will appear in groups of lines beneath it (see figure 16.5).

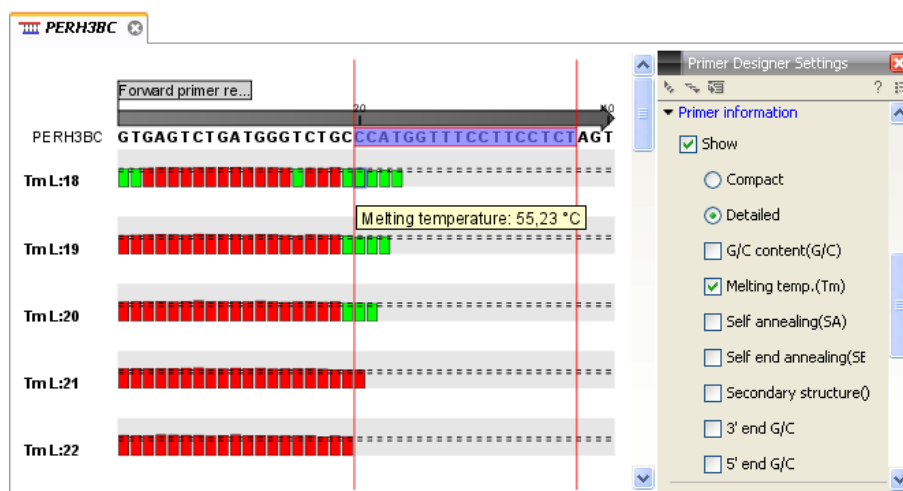

Figure 16.5: Detailed information mode

The number of information-line-groups reflects the chosen length interval for primers and probes. One group is shown for every possible primer length. Within each group, a line is shown for every primer property that is selected from the checkboxes in the primer information preference group. Primer properties are shown at each potential primer starting position and are of two types:

Properties with numerical values are represented by bar plots. A green bar represents the starting point of a primer that meets the set requirement and a red bar represents the starting point of a primer that fails to meet the set requirement:

- G/C content
- Melting temperature
- Self annealing score
- Self end annealing score
- Secondary structure score

Properties with Yes - No values. If a primer meets the set requirement a green circle will be shown at its starting position and if it fails to meet the requirement a red dot is shown at its starting position:

- C/G at 3' end
- C/G at 5' end

Common to both sorts of properties is that mouse clicking an information point (filled circle or bar) will cause the region covered by the associated primer to be selected on the sequence.

16.4 Output from primer design

The output generated by the primer design algorithm is a table of proposed primers or primer pairs with the accompanying information (see figure 16.6).

The screenshot shows a software window titled "pcDNA3-atp8a1...". The main area displays a table of "Standard primers for 'pcDNA3-atp8a1 primers'". The table has 7 columns: Score, Pair annealing align (Fwd,Rev), Fragment length..., Sequence Fwd, Melt. temp. Fwd, Sequence Rev, and Melt. temp. Rev. Three rows of primer pairs are visible. To the right, a "Primer Table Settings" panel allows customizing which columns are shown, with checkboxes for Score, Pair annealing (Fwd,Rev), Pair annealing align (Fwd,Rev), Pair end-annealing (Fwd,Rev), Fragment length (Fwd,Rev), Sequence Fwd, Region Fwd, Self annealing Fwd, and Self annealing alignment Fwd.

Score	Pair annealing align (Fwd,Rev)	Fragment length...	Sequence Fwd	Melt. temp. Fwd	Sequence Rev	Melt. temp. Rev
62,56	GGTGGGAGGCTCTATATAA AAGGAGATAAGACTCAAGG	598,00	GGTGGGAGGCTCTATATAA	48,572	GGAAGTGAAGTATAGAGGAA	49,094
57,873	GGTGGGAGGCTCTATATAA AAGGAGATAAGACTCAAGG	598,00	GGTGGGAGGCTCTATATAA	48,572	GGAAGTGAAGTATAGAGGAA	49,566
55,921	GGGTGGATAGCGGTTTGA AGAACTACTTGGTCCGAG	660,00	GGGTGGATAGCGGTTTGA	56,978	GAGGCTGGTTGATGAAGA	56,439

Figure 16.6: Proposed primers

In the preference panel of the table, it is possible to customize which columns are shown in the table. See the sections below on the different reaction types for a description of the available information.

The columns in the output table can be sorted by the present information. For example the user can choose to sort the available primers by their score (default) or by their self annealing score, simply by right-clicking the column header.

The output table interacts with the accompanying primer editor such that when a proposed combination of primers and probes is selected in the table the primers and probes in this solution are highlighted on the sequence.

16.4.1 Saving primers

Primer solutions in a table row can be saved by selecting the row and using the right-click mouse menu. This opens a dialog that allows the user to save the primers to the desired location. Primers and probes are saved as DNA sequences in the program. This means that all available DNA analyzes can be performed on the saved primers. Furthermore, the primers can be edited using the standard sequence view to introduce e.g. mutations and restriction sites.

16.4.2 Saving PCR fragments

The PCR fragment generated from the primer pair in a given table row can also be saved by selecting the row and using the right-click mouse menu. This opens a dialog that allows the user to save the fragment to the desired location. The fragment is saved as a DNA sequence and the position of the primers is added as annotation on the sequence. The fragment can then be used for further analysis and included in e.g. an in-silico cloning experiment using the cloning editor.

16.4.3 Adding primer binding annotation

You can add an annotation to the template sequence specifying the binding site of the primer: Right-click the primer in the table and select **Mark primer annotation on sequence**.

16.5 Standard PCR

This mode is used to design primers for a PCR amplification of a single DNA fragment.

16.5.1 User input

In this mode the user must define either a *Forward primer region*, a *Reverse primer region*, or both. These are defined by making a selection on the sequence and right-clicking the selection. It is also possible to define a *Region to amplify* in which case a forward- and a reverse primer region are automatically placed so as to ensure that the designated region will be included in the PCR fragment. If areas are known where primers must not bind (e.g. repeat rich areas), one or more *No primers here* regions can be defined.

If two regions are defined, it is required that at least a part of the *Forward primer region* is located upstream of the *Reverse primer region*.

After exploring the available primers (see section 16.3) and setting the desired parameter values in the Primer Parameters preference group, the **Calculate** button will activate the primer design algorithm.

When a single primer region is defined

If only a single region is defined, only *single primers* will be suggested by the algorithm.

After pressing the **Calculate** button a dialog will appear (see figure 16.7).

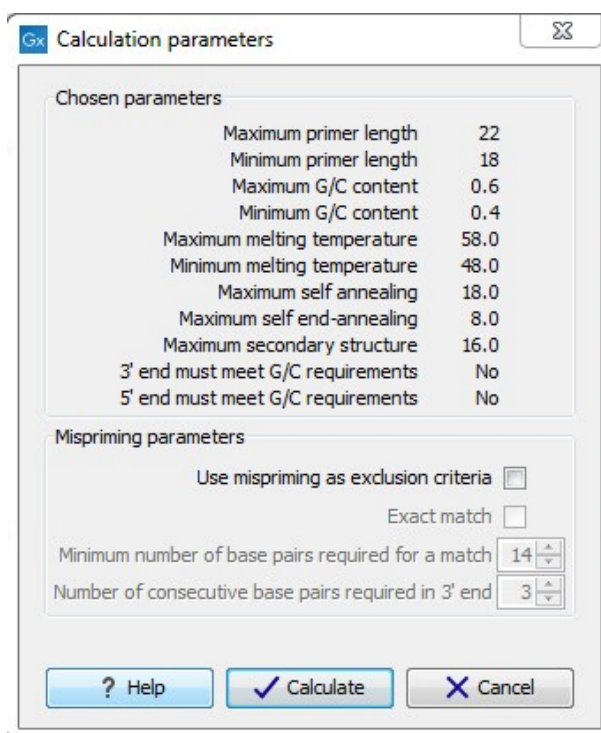

Figure 16.7: Calculation dialog for PCR primers when only a single primer region has been defined.

The top part of this dialog shows the parameter settings chosen in the Primer parameters preference group which will be used by the design algorithm.

Mispriming: The lower part contains a menu where the user can choose to include mispriming as an exclusion criteria in the design process. If this option is selected the algorithm will search for competing binding sites of the primer within the rest of the sequence, to see if the primer would match to multiple locations. If a competing site is found (according to the parameters set), the primer will be excluded.

The adjustable parameters for the search are:

- **Exact match.** Choose only to consider exact matches of the primer, i.e. all positions must base pair with the template for mispriming to occur.
- **Minimum number of base pairs required for a match.** How many nucleotides of the primer that must base pair to the sequence in order to cause mispriming.
- **Number of consecutive base pairs required in 3' end.** How many consecutive 3' end base pairs in the primer that MUST be present for mispriming to occur. This option is included since 3' terminal base pairs are known to be essential for priming to occur.

Note! Including a search for potential mispriming sites will prolong the search time substantially if long sequences are used as template and if the minimum number of base pairs required for a match is low. If the region to be amplified is part of a very long molecule and mispriming is a concern, consider extracting part of the sequence prior to designing primers.

When both forward and reverse regions are defined

If both a forward and a reverse region are defined, *primer pairs* will be suggested by the algorithm.

After pressing the **Calculate** button a dialog will appear (see figure 16.8).

Again, the top part of this dialog shows the parameter settings chosen in the Primer parameters preference group which will be used by the design algorithm. The lower part again contains a menu where the user can choose to include mispriming of both primers as a criteria in the design process (see section 16.5.1). The central part of the dialog contains parameters pertaining to primer pairs. Here three parameters can be set:

- Maximum percentage point difference in G/C content - if this is set at e.g. 5 points a pair of primers with 45% and 49% G/C nucleotides, respectively, will be allowed, whereas a pair of primers with 45% and 51% G/C nucleotides, respectively will not be included.
- Maximal difference in melting temperature of primers in a pair - the number of degrees Celsius that primers in a pair are all allowed to differ.
- Max hydrogen bonds between pairs - the maximum number of hydrogen bonds allowed between the forward and the reverse primer in a primer pair.
- Max hydrogen bonds between pair ends - the maximum number of hydrogen bonds allowed in the consecutive ends of the forward and the reverse primer in a primer pair.
- Maximum length of amplicon - determines the maximum length of the PCR fragment.

Chosen parameters	
Maximum primer length	22
Minimum primer length	18
Maximum G/C content	0.6
Minimum G/C content	0.4
Maximum melting temperature	58.0
Minimum melting temperature	48.0
Maximum self annealing	18.0
Maximum self end-annealing	8.0
Maximum secondary structure	16.0
3' end must meet G/C requirements	No
5' end must meet G/C requirements	No

Primer combination parameters	
Max percentage point difference in G/C content	35
Max difference in melting temperatures within a primer pair	5
Max hydrogen bonds between pairs	18
Max hydrogen bonds between pair ends	8
Maximum length of amplicon	4,000

Mispriming parameters	
Use mispriming as exclusion criteria	<input type="checkbox"/>
Exact match	<input type="checkbox"/>
Minimum number of base pairs required for a match	14
Number of consecutive base pairs required in 3' end	3

Figure 16.8: Calculation dialog for PCR primers when two primer regions have been defined.

16.5.2 Standard PCR output table

If only a single region is selected the following columns of information are available:

- Sequence - the primer's sequence.
- Score - measures how much the properties of the primer (or primer pair) deviates from the optimal solution in terms of the chosen parameters and tolerances. The higher the score, the better the solution. The scale is from 0 to 100.
- Region - the interval of the template sequence covered by the primer
- Self annealing - the maximum self annealing score of the primer in units of hydrogen bonds
- Self annealing alignment - a visualization of the highest maximum scoring self annealing alignment
- Self end annealing - the maximum score of consecutive end base-pairings allowed between the ends of two copies of the same molecule in units of hydrogen bonds
- GC content - the fraction of G and C nucleotides in the primer
- Melting temperature of the primer-template complex
- Secondary structure score - the score of the optimal secondary DNA structure found for the primer. Secondary structures are scored by adding the number of hydrogen bonds in the structure, and 2 extra hydrogen bonds are added for each stacking base-pair in the structure

- Secondary structure - a visualization of the optimal DNA structure found for the primer

If both a forward and a reverse region are selected a table of primer pairs is shown, where the above columns (excluding the score) are represented twice, once for the forward primer (designated by the letter F) and once for the reverse primer (designated by the letter R).

Before these, and following the score of the primer pair, are the following columns pertaining to primer pair-information available:

- Pair annealing - the number of hydrogen bonds found in the optimal alignment of the forward and the reverse primer in a primer pair
- Pair annealing alignment - a visualization of the optimal alignment of the forward and the reverse primer in a primer pair.
- Pair end annealing - the maximum score of consecutive end base-pairings found between the ends of the two primers in the primer pair, in units of hydrogen bonds
- Fragment length - the length (number of nucleotides) of the PCR fragment generated by the primer pair

16.6 Nested PCR

Nested PCR is a modification of Standard PCR, aimed at reducing product contamination due to the amplification of unintended primer binding sites (mispriming). If the intended fragment can not be amplified without interference from competing binding sites, the idea is to seek out a larger outer fragment which can be unambiguously amplified and which contains the smaller intended fragment. Having amplified the outer fragment to large numbers, the PCR amplification of the inner fragment can proceed and will yield amplification of this with minimal contamination.

Primer design for nested PCR thus involves designing two primer pairs, one for the outer fragment and one for the inner fragment.

In *Nested PCR* mode the user must thus define four regions a *Forward primer region* (the outer forward primer), a *Reverse primer region* (the outer reverse primer), a *Forward inner primer region*, and a *Reverse inner primer region*. These are defined by making a selection on the sequence and right-clicking the selection. If areas are known where primers must not bind (e.g. repeat rich areas), one or more *No primers here* regions can be defined.

It is required that the *Forward primer region*, is located upstream of the *Forward inner primer region*, that the *Forward inner primer region*, is located upstream of the *Reverse inner primer region*, and that the *Reverse inner primer region*, is located upstream of the *Reverse primer region*.

In *Nested PCR* mode the *Inner melting temperature* menu in the Primer parameters panel is activated, allowing the user to set a separate melting temperature interval for the inner and outer primer pairs.

After exploring the available primers (see section 16.3) and setting the desired parameter values in the Primer parameters preference group, the **Calculate** button will activate the primer design algorithm.

After pressing the **Calculate** button a dialog will appear (see figure 16.9).

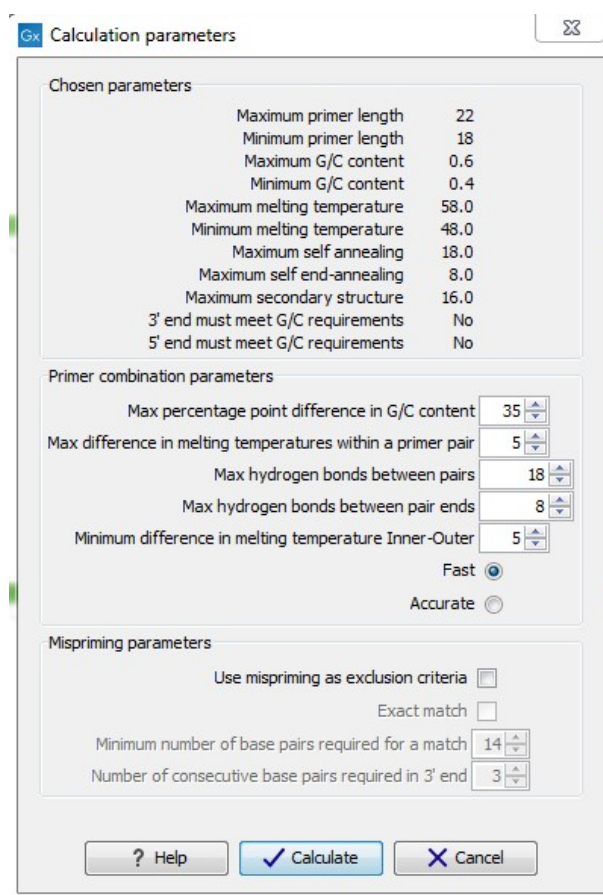

Figure 16.9: Calculation dialog

The top and bottom parts of this dialog are identical to the *Standard PCR* dialog for designing primer pairs described above.

The central part of the dialog contains parameters pertaining to primer pairs and the comparison between the outer and the inner pair. Here five options can be set:

- Maximum percentage point difference in G/C content (described above under *Standard PCR*) - this criteria is applied to both primer pairs independently.
- Maximal difference in melting temperature of primers in a pair - the number of degrees Celsius that primers in a pair are all allowed to differ. This criteria is applied to both primer pairs independently.
- Maximum pair annealing score - the maximum number of hydrogen bonds allowed between the forward and the reverse primer in a primer pair. This criteria is applied to all possible combinations of primers.
- Minimum difference in the melting temperature of primers in the inner and outer primer pair - all comparisons between the melting temperature of primers from the two pairs must be at least this different, otherwise the primer set is excluded. This option is applied to ensure that the inner and outer PCR reactions can be initiated at different annealing temperatures. Please note that to ensure flexibility there is no directionality indicated when setting parameters for melting temperature differences between inner and outer primer

pair, i.e. it is not specified whether the inner pair should have a lower or higher T_m . Instead this is determined by the allowed temperature intervals for inner and outer primers that are set in the primer parameters preference group in the side panel. If a higher T_m of inner primers is desired, choose a T_m interval for inner primers which has higher values than the interval for outer primers.

- Two radio buttons allowing the user to choose between a fast and an accurate algorithm for primer prediction.

16.6.1 Nested PCR output table

In nested PCR there are four primers in a solution, forward outer primer (FO), forward inner primer (FI), reverse inner primer (RI) and a reverse outer primer (RO).

The output table can show primer-pair combination parameters for all four combinations of primers and single primer parameters for all four primers in a solution (see section on Standard PCR for an explanation of the available primer-pair and single primer information).

The fragment length in this mode refers to the length of the PCR fragment generated by the inner primer pair, and this is also the PCR fragment which can be exported.

16.7 TaqMan

CLC Genomics Workbench allows the user to design primers and probes for TaqMan PCR applications.

TaqMan probes are oligonucleotides that contain a fluorescent reporter dye at the 5' end and a quenching dye at the 3' end. Fluorescent molecules become excited when they are irradiated and usually emit light. However, in a TaqMan probe the energy from the fluorescent dye is transferred to the quencher dye by fluorescence resonance energy transfer as long as the quencher and the dye are located in close proximity i.e. when the probe is intact. TaqMan probes are designed to anneal within a PCR product amplified by a standard PCR primer pair. If a TaqMan probe is bound to a product template, the replication of this will cause the Taq polymerase to encounter the probe. Upon doing so, the 5' exonuclease activity of the polymerase will cleave the probe. This cleavage separates the quencher and the dye, and as a result the reporter dye starts to emit fluorescence.

The TaqMan technology is used in Real-Time quantitative PCR. Since the accumulation of fluorescence mirrors the accumulation of PCR products it can be monitored in real-time and used to quantify the amount of template initially present in the buffer.

The technology is also used to detect genetic variation such as SNP's. By designing a TaqMan probe which will specifically bind to one of two or more genetic variants it is possible to detect genetic variants by the presence or absence of fluorescence in the reaction.

A specific requirement of TaqMan probes is that a G nucleotide can not be present at the 5' end since this will quench the fluorescence of the reporter dye. It is recommended that the melting temperature of the TaqMan probe is about 10 degrees celsius higher than that of the primer pair.

Primer design for TaqMan technology involves designing a primer pair and a TaqMan probe.

In *TaqMan* the user must thus define three regions: a *Forward primer region*, a *Reverse primer*

region, and a *TaqMan probe region*. The easiest way to do this is to designate a *TaqMan primer/probe region* spanning the sequence region where TaqMan amplification is desired. This will automatically add all three regions to the sequence. If more control is desired about the placing of primers and probes the *Forward primer region*, *Reverse primer region* and *TaqMan probe region* can all be defined manually. If areas are known where primers or probes must not bind (e.g. repeat rich areas), one or more *No primers here* regions can be defined. The regions are defined by making a selection on the sequence and right-clicking the selection.

It is required that at least a part of the *Forward primer region* is located upstream of the *TaqMan Probe region*, and that the *TaqMan Probe region*, is located upstream of a part of the *Reverse primer region*.

In *TaqMan* mode the *Inner melting temperature* menu in the primer parameters panel is activated allowing the user to set a separate melting temperature interval for the TaqMan probe.

After exploring the available primers (see section 16.3) and setting the desired parameter values in the Primer Parameters preference group, the **Calculate** button will activate the primer design algorithm.

After pressing the **Calculate** button a dialog will appear (see figure 16.10) which is similar to the *Nested PCR* dialog described above (see section 16.6).

Chosen parameters	
Maximum primer length	22
Minimum primer length	18
Maximum G/C content	0.6
Minimum G/C content	0.4
Maximum melting temperature	58.0
Minimum melting temperature	48.0
Maximum self annealing	18.0
Maximum self end-annealing	8.0
Maximum secondary structure	16.0
3' end must meet G/C requirements	No
5' end must meet G/C requirements	No

Primer combination parameters	
Max percentage point difference in G/C content	35
Max difference in melting temperatures within a primer pair	5
Max hydrogen bonds between pairs	18
Max hydrogen bonds between pair ends	8
Minimum difference in melting temperature Inner-Outer	5
Maximum length of amplicon	300

Mispriming parameters	
Use mispriming as exclusion criteria	<input type="checkbox"/>
Exact match	<input type="checkbox"/>
Minimum number of base pairs required for a match	12
Number of consecutive base pairs required in 3' end	3

? Help ✓ Calculate ✕ Cancel

Figure 16.10: Calculation dialog

In this dialog the options to set a minimum and a desired melting temperature difference between outer and inner refers to primer pair and probe respectively.

Furthermore, the central part of the dialog contains an additional parameter

- Maximum length of amplicon - determines the maximum length of the PCR fragment generated in the TaqMan analysis.

16.7.1 TaqMan output table

In TaqMan mode there are two primers and a probe in a given solution, forward primer (F), reverse primer (R) and a TaqMan probe (TP).

The output table can show primer/probe-pair combination parameters for all three combinations of primers and single primer parameters for both primers and the TaqMan probe (see section on Standard PCR for an explanation of the available primer-pair and single primer information).

The fragment length in this mode refers to the length of the PCR fragment generated by the primer pair, and this is also the PCR fragment which can be exported.

16.8 Sequencing primers

This mode is used to design primers for DNA sequencing.

In this mode the user can define a number of *Forward primer regions* and *Reverse primer regions* where a sequencing primer can start. These are defined by making a selection on the sequence and right-clicking the selection. If areas are known where primers must not bind (e.g. repeat rich areas), one or more *No primers here* regions can be defined.

No requirements are instated on the relative position of the regions defined.

After exploring the available primers (see section 16.3) and setting the desired parameter values in the Primer Parameters preference group, the **Calculate** button will activate the primer design algorithm.

After pressing the **Calculate** button a dialog will appear (see figure 16.11).

Since design of sequencing primers does not require the consideration of interactions between primer pairs, this dialog is identical to the dialog shown in *Standard PCR* mode when only a single primer region is chosen. See the section 16.5 for a description.

16.8.1 Sequencing primers output table

In this mode primers are predicted independently for each region, but the optimal solutions are all presented in one table. The solutions are numbered consecutively according to their position on the sequence such that the forward primer region closest to the 5' end of the molecule is designated F1, the next one F2 etc.

For each solution, the single primer information described under Standard PCR is available in the table.

16.9 Alignment-based primer and probe design

CLC Genomics Workbench allows the user to design PCR primers and TaqMan probes based on an alignment of multiple sequences.

The primer designer for alignments can be accessed in two ways:

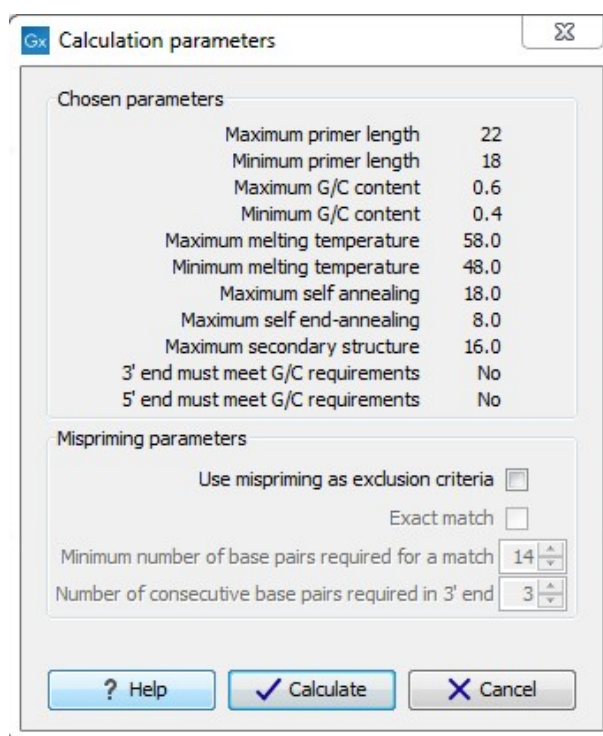

Figure 16.11: Calculation dialog for sequencing primers

Toolbox | Molecular Biology Tools (🔧) | Primers and Probes (📄) | Design Primers (🔍)

or **If the alignment is already open: | Click Primer Designer (🔍) in the lower left part of the view**

In the alignment primer view (see figure 16.12), the basic options for viewing the template alignment are the same as for the standard view of alignments.

See section 19 for an explanation of these options.

Note! This means that annotations such as e.g. known SNPs or exons, can be displayed on the template sequence to guide the choice of primer regions. Since the definition of groups of sequences is essential to the primer design, the selection boxes of the standard view are shown as default in the alignment primer view.

16.9.1 Specific options for alignment-based primer and probe design

Compared to the primer view of a single sequence the most notable difference is that the alignment primer view has no available graphical information. Furthermore, the selection boxes found to the left of the names in the alignment play an important role in specifying the oligo design process. This is elaborated below. The **Primer Parameters** group in the **Side Panel** has the same options for specifying primer requirements, but differs by the following (see figure 16.12):

- In the **Mode** submenu which specifies the reaction types the following options are found:
 - **Standard PCR.** Used when the objective is to design primers, or primer pairs, for PCR amplification of a single DNA fragment.



Figure 16.12: The initial view of an alignment used for primer design.

- **TaqMan.** Used when the objective is to design a primer pair and a probe set for TaqMan quantitative PCR.
- The **Primer solution** submenu is used to specify requirements for the match of a PCR primer against the template sequences. These options are described further below. It contains the following options:
 - **Perfect match.**
 - **Allow degeneracy.**
 - **Allow mismatches.**

The work flow when designing alignment based primers and probes is as follows:

- Use selection boxes to specify groups of included and excluded sequences. To select all the sequences in the alignment, right-click one of the selection boxes and choose **Mark All**.
- Mark either a single forward primer region, a single reverse primer region or both on the sequence (and perhaps also a TaqMan region). Selections must cover all sequences in the included group. You can also specify that there should be no primers in a region (No Primers Here) or that a whole region should be amplified (Region to Amplify).
- Adjust parameters regarding single primers in the preference panel.
- Click the **Calculate** button.

16.9.2 Alignment based design of PCR primers

In this mode, a single or a pair of PCR primers are designed. *CLC Genomics Workbench* allows the user to design primers which will specifically amplify a group of *included* sequences but **not** amplify the remainder of the sequences, the *excluded* sequences. The selection boxes are used to indicate the status of a sequence, if the box is checked the sequence belongs to the included

sequences, if not, it belongs to the excluded sequences. To design primers that are general for all primers in an alignment, simply add them all to the set of included sequences by checking all selection boxes. Specificity of priming is determined by criteria set by the user in the dialog box which is shown when the **Calculate** button is pressed (see below).

Different options can be chosen concerning the match of the primer to the template sequences in the included group:

- **Perfect match.** Specifies that the designed primers must have a perfect match to all relevant sequences in the alignment. When selected, primers will thus only be located in regions that are completely conserved within the sequences belonging to the included group.
- **Allow degeneracy.** Designs primers that may include ambiguity characters where heterogeneities occur in the included template sequences. The allowed fold of degeneracy is user defined and corresponds to the number of possible primer combinations formed by a degenerate primer. Thus, if a primer covers two 4-fold degenerate site and one 2-fold degenerate site the total fold of degeneracy is $4 * 4 * 2 = 32$ and the primer will, when supplied from the manufacturer, consist of a mixture of 32 different oligonucleotides. When scoring the available primers, degenerate primers are given a score which decreases with the fold of degeneracy.
- **Allow mismatches.** Designs primers which are allowed a specified number of mismatches to the included template sequences. The melting temperature algorithm employed includes the latest thermodynamic parameters for calculating T_m when single-base mismatches occur.

When in Standard PCR mode, clicking the **Calculate** button will prompt the dialog shown in figure 16.13.

The top part of this dialog shows the single-primer parameter settings chosen in the Primer parameters preference group which will be used by the design algorithm.

The central part of the dialog contains parameters pertaining to primer specificity (this is omitted if all sequences belong to the included group). Here, three parameters can be set:

- Minimum number of mismatches - the minimum number of mismatches that a primer must have against all sequences in the excluded group to ensure that it does not prime these.
- Minimum number of mismatches in 3' end - the minimum number of mismatches that a primer must have in its 3' end against all sequences in the excluded group to ensure that it does not prime these.
- Length of 3' end - the number of consecutive nucleotides to consider for mismatches in the 3' end of the primer.

The lower part of the dialog contains parameters pertaining to primer pairs (this is omitted when only designing a single primer). Here, three parameters can be set:

- Maximum percentage point difference in G/C content - if this is set at e.g. 5 points a pair of primers with 45% and 49% G/C nucleotides, respectively, will be allowed, whereas a pair of primers with 45% and 51% G/C nucleotides, respectively will not be included.

- Maximal difference in melting temperature of primers in a pair - the number of degrees Celsius that primers in a pair are all allowed to differ.
- Max hydrogen bonds between pairs - the maximum number of hydrogen bonds allowed between the forward and the reverse primer in a primer pair.
- Maximum length of amplicon - determines the maximum length of the PCR fragment.

The output of the design process is a table of single primers or primer pairs as described for primer design based on single sequences. These primers are specific to the included sequences in the alignment according to the criteria defined for specificity. The only novelty in the table, is that melting temperatures are displayed with both a maximum, a minimum and an average value to reflect that degenerate primers or primers with mismatches may have heterogeneous behavior on the different templates in the group of included sequences.

Chosen parameters	
Maximum primer length	22
Minimum primer length	18
Maximum G/C content	0.6
Minimum G/C content	0.4
Maximum melting temperature	58.0
Minimum melting temperature	48.0
Maximum self-annealing	18.0
Maximum self end-annealing	8.0
Maximum secondary structure	16.0
3' end must meet G/C requirements	No
5' end must meet G/C requirements	No

Exclusion parameters	
Minimum number of mismatches	1
Minimum number of mismatches in 3' end	0
Length of 3' end	1

Primer combination parameters	
Max percentage point difference in G/C content	35
Max difference in melting temperatures within a primer pair	5
Max hydrogen bonds between pairs	18
Max hydrogen bonds between pair ends	8
Maximum length of amplicon	4.000

Figure 16.13: Calculation dialog shown when designing alignment based PCR primers.

16.9.3 Alignment-based TaqMan probe design

CLC Genomics Workbench allows the user to design solutions for TaqMan quantitative PCR which consist of four oligos: a general primer pair which will amplify all sequences in the alignment, a specific TaqMan probe which will match the group of *included* sequences but **not** match the *excluded* sequences and a specific TaqMan probe which will match the group of *excluded* sequences but **not** match the *included* sequences. As above, the selection boxes are used to indicate the status of a sequence, if the box is checked the sequence belongs to the included sequences, if not, it belongs to the excluded sequences. We use the terms included and excluded here to be consistent with the section above although a probe solution is presented for both groups. In TaqMan mode, primers are not allowed degeneracy or mismatches to any template sequence in the alignment, variation is only allowed/required in the TaqMan probes.

Pushing the **Calculate** button will cause the dialog shown in figure 16.14 to appear.

The top part of this dialog is identical to the *Standard PCR* dialog for designing primer pairs described above.

The central part of the dialog contains parameters to define the specificity of TaqMan probes. Two parameters can be set:

- Minimum number of mismatches - the minimum total number of mismatches that must exist between a specific TaqMan probe and all sequences which belong to the group not recognized by the probe.
- Minimum number of mismatches in central part - the minimum number of mismatches in the central part of the oligo that must exist between a specific TaqMan probe and all sequences which belong to the group not recognized by the probe.

The lower part of the dialog contains parameters pertaining to primer pairs and the comparison between the outer oligos (primers) and the inner oligos (TaqMan probes). Here, five options can be set:

- Maximum percentage point difference in G/C content (described above under *Standard PCR*).
- Maximal difference in melting temperature of primers in a pair - the number of degrees Celsius that primers in the primer pair are all allowed to differ.
- Maximum pair annealing score - the maximum number of hydrogen bonds allowed between the forward and the reverse primer in an oligo pair. This criteria is applied to all possible combinations of primers and probes.
- Minimum difference in the melting temperature of primer (outer) and TaqMan probe (inner) oligos - all comparisons between the melting temperature of primers and probes must be at least this different, otherwise the solution set is excluded.
- Desired temperature difference in melting temperature between outer (primers) and inner (TaqMan) oligos - the scoring function discounts solution sets which deviate greatly from this value. Regarding this, and the minimum difference option mentioned above, please note that to ensure flexibility there is no directionality indicated when setting parameters for melting temperature differences between probes and primers, i.e. it is not specified whether the probes should have a lower or higher T_m . Instead this is determined by the allowed temperature intervals for inner and outer oligos that are set in the primer parameters preference group in the side panel. If a higher T_m of probes is required, choose a T_m interval for probes which has higher values than the interval for outer primers.

The output of the design process is a table of solution sets. Each solution set contains the following: a set of primers which are general to all sequences in the alignment, a TaqMan probe which is specific to the set of included sequences (sequences where selection boxes are checked) and a TaqMan probe which is specific to the set of excluded sequences (marked by *). Otherwise, the table is similar to that described above for TaqMan probe prediction on single sequences.

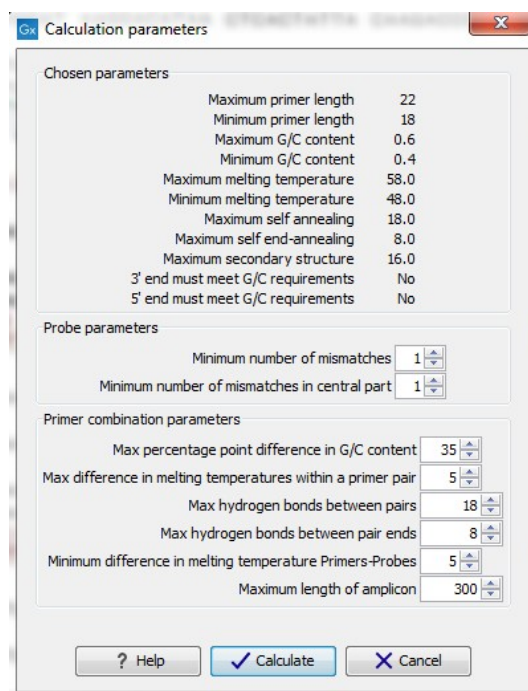

Figure 16.14: Calculation dialog shown when designing alignment based TaqMan probes.

16.10 Analyze primer properties

CLC Genomics Workbench can calculate and display the properties of predefined primers and probes:

Toolbox | Molecular Biology Tools (🔧) | Primers and Probes (📄) | Analyze Primer Properties (🔍)

If a sequence was selected before choosing the Toolbox action, this sequence is now listed in the **Selected Elements** window of the dialog. Use the arrows to add or remove a sequence from the selected elements. (Primers are represented as DNA sequences in the Navigation Area).

Clicking **Next** generates the dialog seen in figure 16.15:

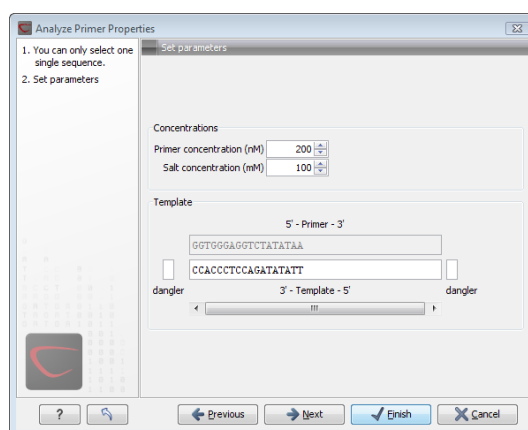

Figure 16.15: The parameters for analyzing primer properties.

In the *Concentrations* panel a number of parameters can be specified concerning the reaction mixture and which influence melting temperatures

- **Primer concentration.** Specifies the concentration of primers and probes in units of nanomoles (nM)
- **Salt concentration.** Specifies the concentration of monovalent cations ($[NA^+]$, $[K^+]$ and equivalents) in units of millimoles (mM)

In the *Template panel* the sequences of the chosen primer and the template sequence are shown. The template sequence is as default set to the reverse complement of the primer sequence i.e. as perfectly base-pairing. However, it is possible to edit the template to introduce mismatches which may affect the melting temperature. At each side of the template sequence a text field is shown. Here, the dangling ends of the template sequence can be specified. These may have an important affect on the melting temperature [Bommarito et al., 2000]

Click **Next** if you wish to adjust how to handle the results (see section 8.2). If not, click **Finish**. The result is shown in figure 16.16:

Sequence	Melt. temp.	Self annealing alignment	Secondary structure
GGTGGGAGGCTATATAA	50.49	<pre> GGTGGGAGGCTATATAA AATATATCTGGAGGGTGG </pre>	

Figure 16.16: Properties of a primer from the Example Data.

In the **Side Panel** you can specify the information to display about the primer. The information parameters of the primer properties table are explained in section 16.5.2.

16.11 Find binding sites and create fragments

In *CLC Genomics Workbench* you have the possibility of matching known primers against one or more DNA sequences or a list of DNA sequences. This can be applied to test whether a primer used in a previous experiment is applicable to amplify a homologous region in another species, or to test for potential mispriming. This functionality can also be used to extract the resulting PCR product when two primers are matched. This is particularly useful if your primers have extensions in the 5' end. Note that this tool is not meant to analyze rapidly high-throughput data. The maximum amount of sequences the tool will handle in a reasonable amount of time depends on your computer processing capabilities.

To search for primer binding sites:

Toolbox | Molecular Biology Tools (🔧) | Primers and Probes (📁) | Find Binding Sites and Create Fragments (🔍)

If a sequence was already selected in the Navigation Area, this sequence is now listed in the **Selected Elements** window of the dialog. Use the arrows to add or remove sequences or sequence lists from the selected elements.

Click **Next** when all the sequence have been added.

Note! You should not add the primer sequences at this step.

16.11.1 Binding parameters

This opens the dialog displayed in figure 16.17:

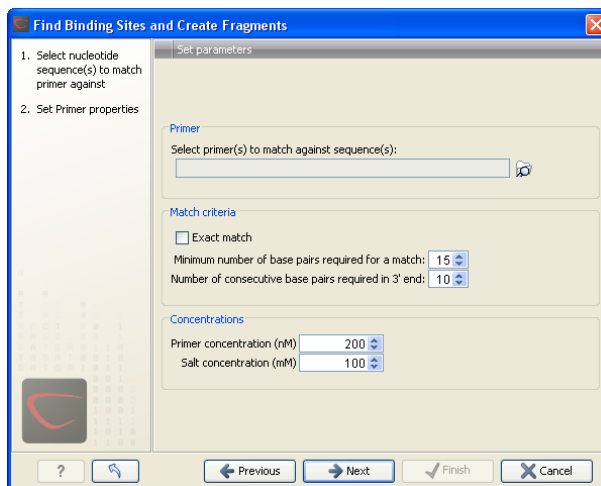

Figure 16.17: Search parameters for finding primer binding sites.

At the top, select one or more primers by clicking the browse (🔍) button. In *CLC Genomics Workbench*, primers are just DNA sequences like any other, but there is a filter on the length of the sequence. Only sequences up to 400 bp can be added.

The **Match criteria** for matching a primer to a sequence are:

- **Exact match.** Choose only to consider exact matches of the primer, i.e. all positions must base pair with the template.
- **Minimum number of base pairs required for a match.** How many nucleotides of the primer that must base pair to the sequence in order to cause priming/mispriming.
- **Number of consecutive base pairs required in 3' end.** How many consecutive 3' end base pairs in the primer that **MUST** be present for priming/mispriming to occur. This option is included since 3' terminal base pairs are known to be essential for priming to occur.

Note that the number of mismatches is reported in the output, so you will be able to filter on this afterwards (see below).

Below the match settings, you can adjust **Concentrations** concerning the reaction mixture. This is used when reporting melting temperatures for the primers.

- **Primer concentration.** Specifies the concentration of primers and probes in units of nanomoles (nM)
- **Salt concentration.** Specifies the concentration of monovalent cations ($[NA^+]$, $[K^+]$ and equivalents) in units of millimoles (mM)

16.11.2 Results - binding sites and fragments

Click **Next** to specify the output options as shown in figure 16.18:

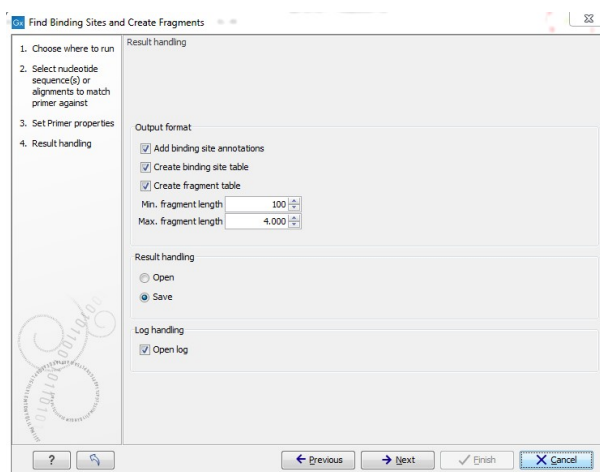

Figure 16.18: Output options include reporting of binding sites and fragments.

The output options are:

- **Add binding site annotations.** This will add annotations to the input sequences (see details below).
- **Create binding site table.** Creates a table of all binding sites. Described in details below.
- **Create fragment table.** Showing a table of all fragments that could result from using the primers. Note that you can set the minimum and maximum sizes of the fragments to be shown. The table is described in detail below.

Click **Next** if you wish to adjust how to handle the results (see section 8.2). If not, click **Finish**.

An example of a **binding site annotation** is shown in figure 16.19.

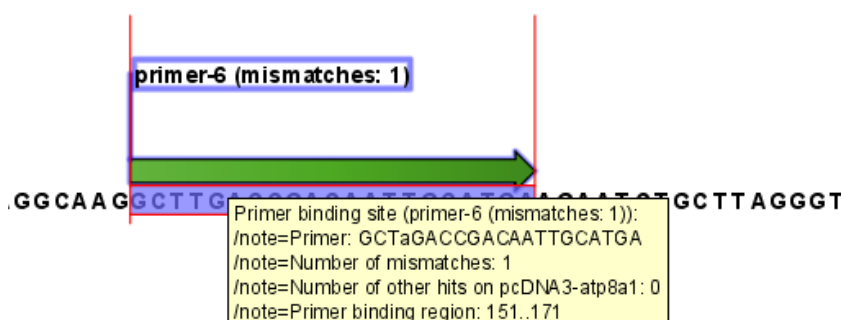

Figure 16.19: Annotation showing a primer match.

The annotation has the following information:

- **Sequence of the primer.** Positions with mismatches will be in lower-case (see the fourth position in figure 16.19 where the primer has an a and the template sequence has a T).
- **Number of mismatches.**

- **Number of other hits on the same sequence.** This number can be useful to check specificity of the primer.
- **Binding region.** This region ends with the 3' exact match and is simply the primer length upstream. This means that if you have 5' extensions to the primer, part of the binding region covers sequence that will actually not be annealed to the primer.

An example of the **primer binding site table** is shown in figure 16.20.

Primer name	Primer Sequence	Orientation	Region	Mismatches	Number of other hit...
Primer 1 - HindIII	aaGcttGGTGGGAGGTCTATATAA	fwd	787..810	5	0
Primer 5	ACGGTGGGAGGTCTATATAA	fwd	791..810	0	0
Primer 1	GTGGGAGGTCTATATAA	fwd	793..810	0	0
Primer 7	GGAAC TGAGAA TAGAGGA	rev	complement(1373..1390)	0	0
Primer 6	AGCAGGCAATAAAGAGAA	rev	complement(1412..1430)	0	0

Figure 16.20: A table showing all binding sites.

The information here is the same as in the primer annotation and furthermore you can see additional information about melting temperature etc. by selecting the options in the **Side Panel**. See a more detailed description of this information in section 16.5.2. You can use this table to browse the binding sites. If you make a split view of the table and the sequence (see section 2.1.7), you can browse through the binding positions by clicking in the table. This will cause the sequence view to jump to the position of the binding site.

An example of a **fragment table** is shown in figure 16.21.

Fwd. name	Rev. name	Fragment length	Region	Other fragments
Primer 1 - HindIII	Primer 7	604	787..1390	0
Primer 5	Primer 7	600	791..1390	0
Primer 1	Primer 7	598	793..1390	0
Primer 1 - HindIII	Primer 6	644	787..1430	0
Primer 5	Primer 6	640	791..1430	0
Primer 1	Primer 6	638	793..1430	0

Figure 16.21: A table showing all possible fragments of the specified size.

The table first lists the names of the forward and reverse primers, then the length of the fragment and the region. The last column tells if there are other possible fragments fulfilling the length

criteria on this sequence. This information can be used to check for competing products in the PCR. In the **Side Panel** you can show information about melting temperature for the primers as well as the difference between melting temperatures.

You can use this table to browse the fragment regions. If you make a split view of the table and the sequence (see section 2.1.7), you can browse through the fragment regions by clicking in the table. This will cause the sequence view to jump to the start position of the fragment.

There are some additional options in the fragment table. First, you can annotate the fragment on the original sequence. This is done by right-clicking (Ctrl-click on Mac) the fragment and choose **Annotate Fragment** as shown in figure 16.22.

Rows: 7		Fragments		Filter:	
Fwd	Rev	Fragment length	Region	Other f	
primer-3	primer-2	1488	1575..3062		
primer-6	primer-1	751	151..401		
primer-6	primer-5 - HindIII	65	151..1615		
primer-6	primer-5	51	151..1601		
primer-6- EcoRV	primer-1	269	133..401		
primer-6- EcoRV	primer-5 - HindIII	1483	133..1615		

Figure 16.22: Right-clicking a fragment allows you to annotate the region on the input sequence or open the fragment as a new sequence.

This will put a *PCR fragment* annotations on the input sequence covering the region specified in the table. As you can see from figure 16.22, you can also choose to **Open Fragment**. This will create a new sequence representing the PCR product that would be the result of using these two primers. Note that if you have extensions on the primers, they will be used to construct the new sequence.

If you are doing restriction cloning using primers with restriction site extensions, you can use this functionality to retrieve the PCR fragment for us in the cloning editor (see section 18.1).

16.12 Order primers

To facilitate the ordering of primers and probes, *CLC Genomics Workbench* offers an easy way of displaying and saving a textual representation of one or more primers:

Toolbox | Molecular Biology Tools  | **Primers and Probes**  | **Order Primers** 

This opens a dialog where you can choose additional primers. Clicking **OK** opens a textual representation of the primers (see figure 16.23). The first line states the number of primers being ordered and after this follows the names and nucleotide sequences of the primers in 5'-3' orientation. From the editor, the primer information can be copied and pasted to web forms or e-mails. The created object can also be saved and exported as a text file.

See figure 16.23

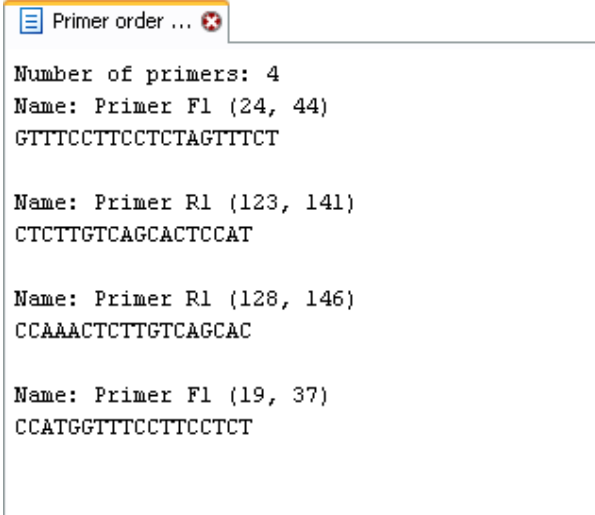

```
Primer order ...  
Number of primers: 4  
Name: Primer F1 (24, 44)  
GTTTCCTTCCTCTAGTTTCT  
  
Name: Primer R1 (123, 141)  
CTCTTGTCAGCACTCCAT  
  
Name: Primer R1 (128, 146)  
CCAAACTCTTGTCAGCAC  
  
Name: Primer F1 (19, 37)  
CCATGGTTTCCTTCCTCT
```

Figure 16.23: A primer order for 4 primers.

Chapter 17

Sequencing data analyses

Contents

17.1 Importing and viewing trace data	402
17.1.1 Scaling traces	402
17.1.2 Trace settings in the Side Panel	402
17.2 Trim sequences	403
17.2.1 Trimming using the Trim tool	404
17.2.2 Manual trimming	406
17.3 Assemble sequences	406
17.4 Assemble sequences to reference	408
17.5 Sort sequences by name	411
17.6 Add sequences to an existing contig	414
17.7 View and edit contigs and read mappings	415
17.7.1 View settings in the Side Panel	416
17.7.2 Editing a contig or read mapping	419
17.7.3 Sorting reads	419
17.7.4 Read conflicts	420
17.7.5 Using the mapping	420
17.7.6 Extract parts of a mapping	420
17.7.7 Variance table	422
17.8 Reassemble contig	424
17.9 Secondary peak calling	425

This chapter explains the features in *CLC Genomics Workbench* for handling data analysis of low-throughput conventional Sanger sequencing data. For analysis of high-throughput sequencing data, please refer to part [IV](#).

This chapter first explains how to trim sequence reads. Next follows a description of how to assemble reads into contigs both with and without a reference sequence. In the final section, the options for viewing and editing contigs are explained.

17.1 Importing and viewing trace data

A number of different binary trace data formats can be imported into the program, including *Standard Chromatogram Format (.SCF)*, *ABI sequencer data files (.ABI and .AB1)*, *PHRED output files (.PHD)* and *PHRAP output files (.ACE)* (see section 6.1).

After import, the sequence reads and their trace data are saved as DNA sequences. This means that all analyses that apply to DNA sequences can be performed on the sequence reads.

You can see additional information about the quality of the traces by holding the mouse cursor on the imported sequence. This will display a tool tip as shown in figure 17.1.

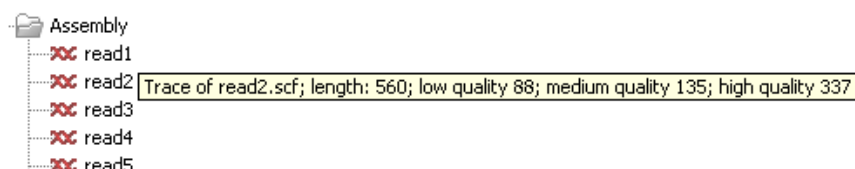

Figure 17.1: A tooltip displaying information about the quality of the chromatogram.

The qualities are based on the phred scoring system, with scores below 19 counted as low quality, scores between 20 and 39 counted as medium quality, and those 40 and above counted as high quality.

If the trace file does not contain information about quality, only the sequence length will be shown.

To view the trace data, open the sequence read in a standard sequence view (ACT).

17.1.1 Scaling traces

The traces can be scaled by dragging the trace vertically as shown in figure 17.2. The Workbench automatically adjust the height of the traces to be readable, but if the trace height varies a lot, this manual scaling is very useful.

The height of the area available for showing traces can be adjusted in the **Side Panel** as described in section 17.1.2.

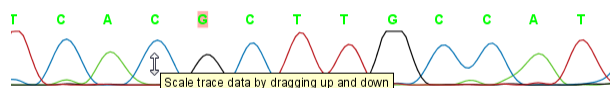

Figure 17.2: Grab the traces to scale.

17.1.2 Trace settings in the Side Panel

In the Nucleotide info preference group the display of trace data can be selected and unselected. When selected, the trace data information is shown as a plot beneath the sequence. The appearance of the plot can be adjusted using the following options (see figure 17.3):

- **Nucleotide trace.** For each of the four nucleotides the trace data can be selected and unselected.

- **Scale traces.** A slider which allows the user to scale the height of the trace area. Scaling the traces individually is described in section 17.1.1.



Figure 17.3: A sequence with trace data. The preferences for viewing the trace are shown in the Side Panel.

When working with stand alone mappings containing reads with trace data, you can view the traces by turning on the trace setting options as described here **and** choosing **Not compact** in the Read layout setting for the mapping. Please see section 24.2.6.

17.2 Trim sequences

Trimming as described in this section involves marking of low quality and/or vector sequence with a Trim annotation as shown in figure 17.4). Such annotated regions are then ignored when using downstream analysis tools located in the same section of the Workbench toolbox, for example Assembly (see section 17.3). The trimming described here annotates, but does not remove data, allowing you to explore the output of different trimming schemes easily.

Trimming as a separate task can be done manually or using a tool designed specifically for this task.

To remove existing trimming information from a sequence, simply remove its trim annotation (see section 10.3.2).

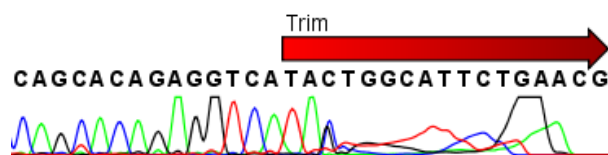

Figure 17.4: Trimming creates annotations on the regions that will be ignored in the assembly process.

Note! If you wish to remove regions that are trimmed, you should instead use the NGS trim tool (see section 22.1).

When exporting sequences in fasta format, there is an option to remove the parts of the sequence covered by trim annotations.

17.2.1 Trimming using the Trim tool

Sequence reads can be trimmed based on a number of different criteria. Using a trimming tool for this is particularly useful if:

- You have many sequences to trim.
- You wish to trim vector contamination from sequencing reads.
- You wish to ensure that consistency when trimming. That is, you wish to ensure the same criteria are used for all the sequences in a set.

To start up the Trim tool in the Workbench, go to the menu option:

Toolbox | Molecular Biology Tools (🔧) | Sequencing Data Analysis (📊) | Trim Sequences (✂️)

This opens a dialog where you can choose the sequences to trim, by using the arrows to move them between the Navigation Area and the 'Selected Elements' box.

When the sequences are selected, click **Next**.

This opens the dialog displayed in figure 17.5.

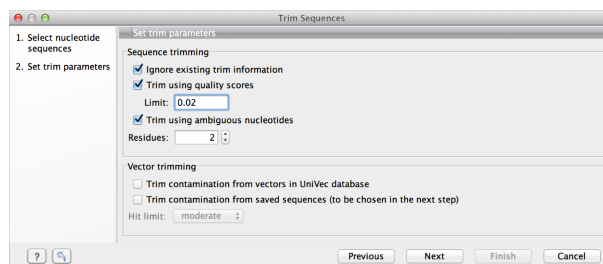

Figure 17.5: Setting parameters for trimming.

The following parameters can be adjusted in the dialog:

- **Ignore existing trim information.** If you have previously trimmed the sequences, you can check this to remove existing trimming annotation prior to analysis.
- **Trim using quality scores.** If the sequence files contain quality scores from a base-caller algorithm this information can be used for trimming sequence ends. The program uses the modified-Mott trimming algorithm for this purpose (Richard Mott, personal communication):
Quality scores in the Workbench are on a Phred scale, and formats using other scales will be converted during import. The Phred quality scores (Q), defined as: $Q = -10 \log_{10}(P)$, where P is the base-calling error probability, can then be used to calculate the error probabilities, which in turn can be used to set the limit for, which bases should be trimmed.
Hence, the first step in the trim process is to convert the quality score (Q) to an error probability: $p_{error} = 10^{-\frac{Q}{10}}$. (This now means that low values are high quality bases.)

Next, for every base a new value is calculated: $Limit - p_{error}$. This value will be negative for low quality bases, where the error probability is high.

For every base, the Workbench calculates the running sum of this value. If the sum drops below zero, it is set to zero. The part of the sequence not trimmed will be the region ending at the highest value of the running sum and starting at the last zero value before this highest score. Everything before and after this region will be trimmed. A read will be completely removed if the score never makes it above zero.

At <http://www.clcbio.com/files/usermanuals/trim.zip> you find an example sequence and an Excel sheet showing the calculations done for this particular sequence to illustrate the procedure described above.

- **Trim ambiguous nucleotides.** This option trims the sequence ends based on the presence of ambiguous nucleotides (typically N). Note that the automated sequencer generating the data must be set to output ambiguous nucleotides in order for this option to apply. The algorithm takes as input the *maximal number of ambiguous nucleotides allowed in the sequence after trimming*. If this maximum is set to e.g. 3, the algorithm finds the maximum length region containing 3 or fewer ambiguities and then trims away the ends not included in this region. The "Trim ambiguous nucleotides" option trims all types of ambiguous nucleotides (see Appendix H).
 - **Trim contamination from vectors in UniVec database.** If selected, the program will match the sequence reads against all vectors in the UniVec database and mark sequence ends with significant matches with a 'Trim' annotation (the database is included when you install the *CLC Genomics Workbench*). A list of all the vectors in the UniVec database can be found at <http://www.ncbi.nlm.nih.gov/VecScreen/replist.html>.
 - **Hit limit.** Specifies how strictly vector contamination is trimmed. Since vector contamination usually occurs at the beginning or end of a sequence, different criteria are applied for terminal and internal matches. A match is considered terminal if it is located within the first 25 bases at either sequence end. Three match categories are defined according to the expected frequency of an alignment with the same score occurring between random sequences. The *CLC Genomics Workbench* uses the same settings as VecScreen (<http://www.ncbi.nlm.nih.gov/VecScreen/VecScreen.html>):
 - * **Weak.** Expect 1 random match in 40 queries of length 350 kb
 - Terminal match with Score 16 to 18.
 - Internal match with Score 23 to 24.
 - * **Moderate.** Expect 1 random match in 1,000 queries of length 350 kb
 - Terminal match with Score 19 to 23.
 - Internal match with Score 25 to 29.
 - * **Strong.** Expect 1 random match in 1,000,000 queries of length 350 kb
 - Terminal match with Score ≥ 24 .
 - Internal match with Score ≥ 30 .
- Note that selecting e.g. **Weak** will also include matches in the **Moderate** and **Strong** categories.
- **Trim contamination from saved sequences.** This option lets you select your own vector sequences that you have imported into the Workbench. If you select this option, you will be able to select one or more sequences when you click **Next**.

Click **Next** if you wish to adjust how to handle the results (see section 8.2). If not, click **Finish**. This will start the trimming process. Views of each trimmed sequence will be shown, and you can inspect the result by looking at the "Trim" annotations (they are colored red as default). Note that the trim annotations are used to signal that this part of the sequence is to be ignored during further analyses, hence the trimmed sequences are not deleted. If there are no trim annotations, the sequence has not been trimmed.

17.2.2 Manual trimming

Sequence reads can be trimmed manually while inspecting their trace and quality data.

Trimming sequences manually involves adding an annotation of type Trim, with the special condition that this annotation can only be applied to the ends of a sequence:



double-click the sequence to trim in the Navigation Area | select the region you want to trim | right-click the selection | Trim sequence left/right to determine the direction of the trimming

This will add a trimming annotation to the end of the sequence in the selected direction. No sequence is being deleted here. Rather, the regions covered by trim annotations are noted by downstream analyses (in the same section of the Workbench Toolbox as the Trim tool) as regions to be ignored.

17.3 Assemble sequences

This section describes how to assemble a number of sequence reads into a contig without the use of a reference sequence (a known sequence that can be used for comparison with the other sequences, see section 17.4).

Note! You can assemble a maximum of 10000 sequences at a time.

To assemble more sequences, please use the **De Novo Assembly**  tool under **De Novo Sequencing**  in the **Toolbox** instead.

To perform the assembly: **Toolbox | Molecular Biology Tools**  | **Sequencing Data Analysis**  | **Assess Sequences** 

This will open a dialog where you can select sequences to assemble. If you already selected sequences in the Navigation Area, these will be shown in 'Selected Elements'. You can alter your choice of sequences to assemble, or add others, by using the arrows to move sequences between the Navigation Area and the 'Selected Elements' box. You can also add sequence lists.

When the sequences are selected, click **Next**. This will show the dialog in figure 17.6

This dialog gives you the following options for assembly:

- **Minimum aligned read length.** The minimum number of nucleotides in a read which must be successfully aligned to the contig. If this criteria is not met by a read, the read is excluded from the assembly.
- **Alignment stringency.** Specifies the stringency of the scoring function used by the alignment step in the contig assembly algorithm. A higher stringency level will tend to produce contigs

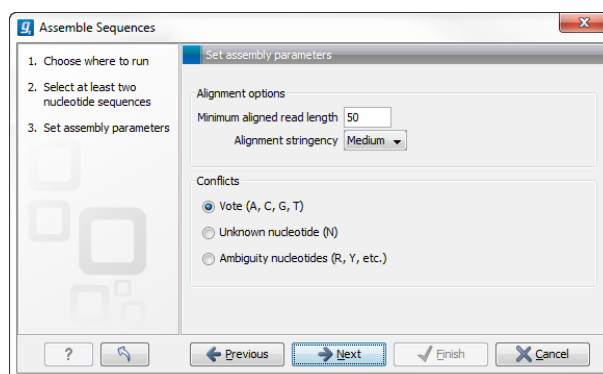

Figure 17.6: Setting assembly parameters.

with fewer ambiguities but will also tend to omit more sequencing reads and to generate more and shorter contigs. Three stringency levels can be set:

- **Low.**
- **Medium.**
- **High.**
- **Conflicts.** If there is a conflict, i.e. a position where there is disagreement about the residue (A, C, T or G), you can specify how the contig sequence should reflect the conflict:
 - **Vote (A, C, G, T).** The conflict will be solved by counting instances of each nucleotide and then letting the majority decide the nucleotide in the contig. In case of equality, ACGT are given priority over one another in the stated order.
 - **Unknown nucleotide (N).** The contig will be assigned an 'N' character in all positions with conflicts (conflicts are registered already when two nucleotides differ).
 - **Ambiguity nucleotides (R, Y, etc.).** The contig will display an ambiguity nucleotide reflecting the different nucleotides found in the reads (nucleotide ambiguity is registered already when two nucleotides differ). For an overview of ambiguity codes, see Appendix H.

Note, that conflicts will always be highlighted no matter which of the options you choose. Furthermore, each conflict will be marked as annotation on the contig sequence and will be present if the contig sequence is extracted for further analysis. As a result, the details of any experimental heterogeneity can be maintained and used when the result of single-sequence analyzes is interpreted. Read more about conflicts in section 17.7.4.

- **Create full contigs, including trace data.** This will create a contig where all the aligned reads are displayed below the contig sequence. (You can always extract the contig sequence without the reads later on.) For more information on how to use the contigs that are created, see section 17.7.
- **Show tabular view of contigs.** A contig can be shown both in a graphical as well as a tabular view. If you select this option, a tabular view of the contig will also be opened (Even if you do not select this option, you can show the tabular view of the contig later on by clicking **Table** (📄) at the bottom of the view.) For more information about the tabular view of contigs, see section 17.7.7.

- **Create only consensus sequences.** This will not display a contig but will only output the assembled contig sequences as single nucleotide sequences. If you choose this option it is not possible to validate the assembly process and edit the contig based on the traces.

Click **Next** if you wish to adjust how to handle the results (see section 8.2). If not, click **Finish**.

When the assembly process has ended, a number of views will be shown, each containing a contig of two or more sequences that have been matched. If the number of contigs seem too high or low, try again with another **Alignment stringency** setting. Depending on your choices of output options above, the views will include trace files or only contig sequences. However, the calculation of the contig is carried out the same way, no matter how the contig is displayed.

See section 17.7 on how to use the resulting contigs.



17.4 Assemble sequences to reference

This section describes how to assemble a number of sequence reads into a contig using a reference sequence, a process called read mapping. A reference sequence can be particularly helpful when the objective is to characterize SNP variation in the data.

Note! You can assemble a maximum of 10000 sequences at a time.

To assemble more sequences, please use the **Map Reads to Reference** () under **NGS Core Tools** () in the **Toolbox**.

To start the assembly:

Toolbox | Molecular Biology Tools () | **Sequencing Data Analysis** () | **Assemble Sequences to Reference** ()

This opens a dialog where you can alter your choice of sequences to assemble. If you have already selected sequences in the Navigation Area, these will be shown in Selected Elements, however you can remove these or add others, by using the arrows to move sequences between the Navigation Area and Selected Elements boxes. You can also add sequence lists.

When the sequences are selected, click **Next**, and you will see the dialog shown in figure 17.7

This dialog gives you the following options for assembling:

- **Reference sequence.** Click the **Browse and select element** icon () in order to select one or more sequences to use as reference(s).
- **Include reference sequence(s) in contig(s).** This will create a contig for each reference with the corresponding reference sequence at the top and the aligned sequences below. This option is useful when comparing sequence reads to a closely related reference sequence e.g. when sequencing for SNP characterization.
 - **Only include part of reference sequence(s) in the contig(s).** If the aligned sequences only cover a small part of a reference sequence, it may not be desirable to include the whole reference sequence in a contig. When this option is selected, you can specify the number of residues from reference sequences that should be included on each side of regions spanned by aligned sequences using the **Extra residues** field.

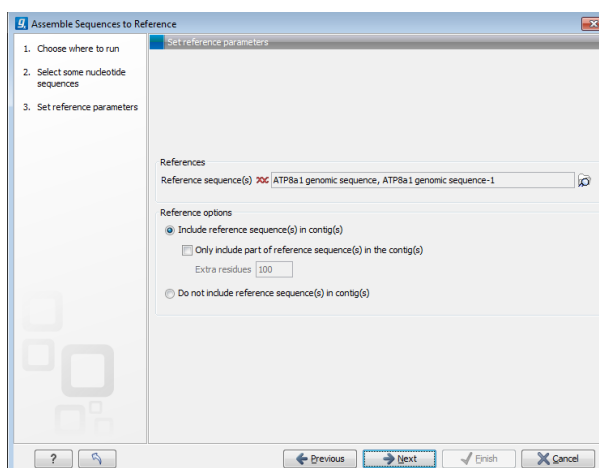

Figure 17.7: Parameters for how the reference should be handled when assembling sequences to a reference sequence.

- **Do not include reference sequence(s) in contig(s).** This will produce contigs without any reference sequence where the input sequences have been assembled using reference sequences as a scaffold. The input sequences are first aligned to the reference sequence(s). Next, the consensus sequence for regions spanned by aligned sequences are extracted and output as contigs. This option is useful when performing assembling sequences where the reference sequences that are not closely related to the input sequencing.

When the reference sequence has been selected, click **Next**, to see the dialog shown in figure 17.8

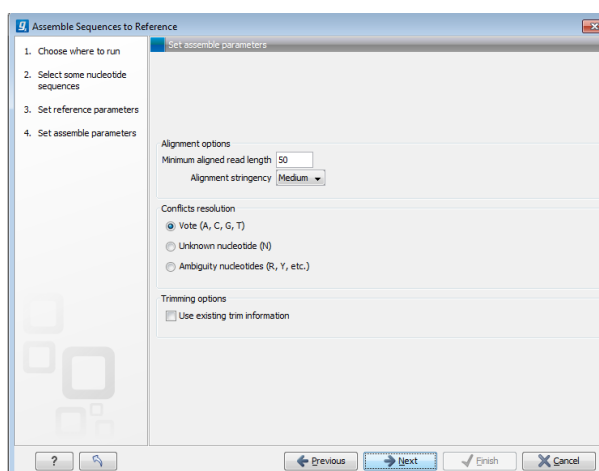

Figure 17.8: Options for how the input sequences should be aligned and how nucleotide conflicts should be handled.

In this dialog, you can specify the following options:

- **Minimum aligned read length.** The minimum number of nucleotides in a read which must match a reference sequence. If an input sequence does not meet this criteria, the sequence is excluded from the assembly.
- **Alignment stringency.** Specifies the stringency of the scoring function used for aligning the input sequences to the reference sequence(s). A higher stringency level often produce

contigs with lower levels of ambiguity but also reduces the ability to align distant homologs or sequences with a high error rate to reference sequences. The result of a higher stringency level is often that the number of contigs increases and the average length of contigs decreases while the quality of each contig increases. Three stringency levels can be set:

- **Low.**
- **Medium.**
- **High.**

The stringency settings Low, Medium and High are based on the following score values (mt=match, ti=transition, tv=transversion, un=unknown):

Score values			
	Low	Medium	High
Match (mt)	2	2	2
Transversion (tv)	-6	-10	-20
Transition (ti)	-2	-6	-16
Unknown (un)	-2	-6	-16
Gap	-8	-16	-36

Score Matrix					
	A	C	G	T	N
A	mt	tv	ti	tv	un
C	tv	mt	tv	ti	un
G	ti	tv	mt	tv	un
T	tv	ti	tv	mt	un
N	un	un	un	un	un

- **Conflicts resolution.** If there is a conflict, i.e. a position where aligned sequences disagreement about the residue (A, C, T or G), you can specify how the contig sequence should reflect this conflict:
 - **Unknown nucleotide (N).** The contig will be assigned an 'N' character in all positions with conflicts (conflicts are registered already when two nucleotides differ).
 - **Ambiguity nucleotides (R, Y, etc.).** The contig will display an ambiguity nucleotide reflecting the different nucleotides found in the aligned sequences (nucleotide ambiguity is registered when two nucleotides differ). For an overview of ambiguity codes, see Appendix H.
 - **Vote (A, C, G, T).** The conflict will be solved by counting instances of each nucleotide and then letting the majority decide the nucleotide in the contig. In case of equality, ACGT are given priority over one another in the stated order.

Note, that conflicts will be highlighted for all options. Furthermore, conflicts will be marked with an annotation on each contig sequence which are preserved if the contig sequence is extracted for further analysis. As a result, the details of any experimental heterogeneity can be maintained and used when the result of single-sequence analyzes is interpreted.

- **Trimming options.** When aligning sequences to a reference sequence, trimming is generally not necessary, but if you wish to use trimming you can check this box. It requires that the sequence reads have been trimmed beforehand (see section 17.2 for more information about trimming).

Click **Next** if you wish to adjust how to handle the results (see section 8.2). If not, click **Finish**. This will start the assembly process. See section 17.7 on how to use the resulting contigs.

17.5 Sort sequences by name

With this functionality you will be able to group sequencing reads based on their file name. A typical example would be that you have a list of files named like this:



```
...  
A02__Asp_F_016_2007-01-10  
A02__Asp_R_016_2007-01-10  
A02__Gln_F_016_2007-01-11  
A02__Gln_R_016_2007-01-11  
A03__Asp_F_031_2007-01-10  
A03__Asp_R_031_2007-01-10  
A03__Gln_F_031_2007-01-11  
A03__Gln_R_031_2007-01-11  
...
```

In this example, the names have five distinct parts (we take the first name as an example):

- **A02** which is the position on the 96-well plate
- **Asp** which is the name of the gene being sequenced
- **F** which describes the orientation of the read (forward/reverse)
- **016** which is an ID identifying the sample
- **2007-01-10** which is the date of the sequencing run

To start mapping these data, you probably want to have them divided into groups instead of having all reads in one folder. If, for example, you wish to map each sample separately, or if you wish to map each gene separately, you cannot simply run the mapping on all the sequences in one step.

That is where **Sort Sequences by Name** comes into play. It will allow you to specify which part of the name should be used to divide the sequences into groups. We will use the example described above to show how it works:

Toolbox | Molecular Biology Tools  | **Sequencing Data Analysis**  | **Sort Sequences by Name** 

This opens a dialog where you can add the sequences you wish to sort, by using the arrows to move them between the Navigation Area and 'Selected Elements'. You can also add sequence

lists or the contents of an entire folder by right-clicking the folder and choose: **Add folder contents**.

When you click **Next**, you will be able to specify the details of how the grouping should be performed. First, you have to choose how each part of the name should be identified. There are three options:

- **Simple**. This will simply use a designated character to split up the name. You can choose a character from the list:
 - Underscore _
 - Dash -
 - Hash (number sign / pound sign) #
 - Pipe |
 - Tilde ~
 - Dot .
- **Positions**. You can define a part of the name by entering the start and end positions, e.g. from character number 6 to 14. For this to work, the names have to be of equal lengths.
- **Java regular expression**. This is an option for advanced users where you can use a special syntax to have total control over the splitting. See more below.

In the example above, it would be sufficient to use a simple split with the underscore _ character, since this is how the different parts of the name are divided.

When you have chosen a way to divide the name, the parts of the name will be listed in the table at the bottom of the dialog. There is a checkbox next to each part of the name. This checkbox is used to specify which of the name parts should be used for grouping. In the example above, if we want to group the reads according to date and analysis position, these two parts should be checked as shown in figure 17.9.

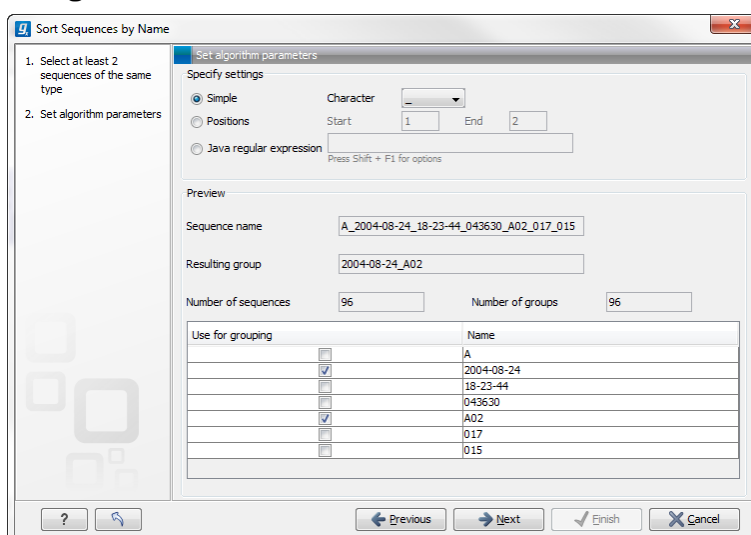

Figure 17.9: Splitting up the name at every underscore (_) and using the date and analysis position for grouping.

At the middle of the dialog there is a preview panel listing:

- **Sequence name.** This is the name of the first sequence that has been chosen. It is shown here in the dialog in order to give you a sample of what the names in the list look like.
- **Resulting group.** The name of the group that this sequence would belong to if you proceed with the current settings.
- **Number of sequences.** The number of sequences chosen in the first step.
- **Number of groups.** The number of groups that would be produced when you proceed with the current settings.

This preview cannot be changed. It is shown to guide you when finding the appropriate settings.

Click **Next** if you wish to adjust how to handle the results (see section 8.2). If not, click **Finish**. A new sequence list will be generated for each group. It will be named according to the group, e.g. 2004-08-24_A02 will be the name of one of the groups in the example shown in figure 17.9.

Advanced splitting using regular expressions

You can see a more detail explanation of the regular expressions syntax in section 13.9.3. In this section you will see a practical example showing how to create a regular expression. Consider a list of files as shown below:

```
...
adk-29_adk1n-F
adk-29_adk2n-R
adk-3_adk1n-F
adk-3_adk2n-R
adk-66_adk1n-F
adk-66_adk2n-R
atp-29_atpA1n-F
atp-29_atpA2n-R
atp-3_atpA1n-F
atp-3_atpA2n-R
atp-66_atpA1n-F
atp-66_atpA2n-R
...
```

In this example, we wish to group the sequences into three groups based on the number after the "-" and before the "_" (i.e. 29, 3 and 66). The simple splitting as shown in figure 17.9 requires the same character before and after the text used for grouping, and since we now have both a "-" and a "_", we need to use the regular expressions instead (note that dividing by position would not work because we have both single and double digit numbers (3, 29 and 66)).

The regular expression for doing this would be `(.*)-(.*)_(.*)` as shown in figure 17.10. The round brackets `()` denote the part of the name that will be listed in the groups table at the bottom of the dialog. In this example we actually did not need the first and last set of brackets, so the expression could also have been `.*(-.*)_.*` in which case only one group would be listed in the table at the bottom of the dialog.

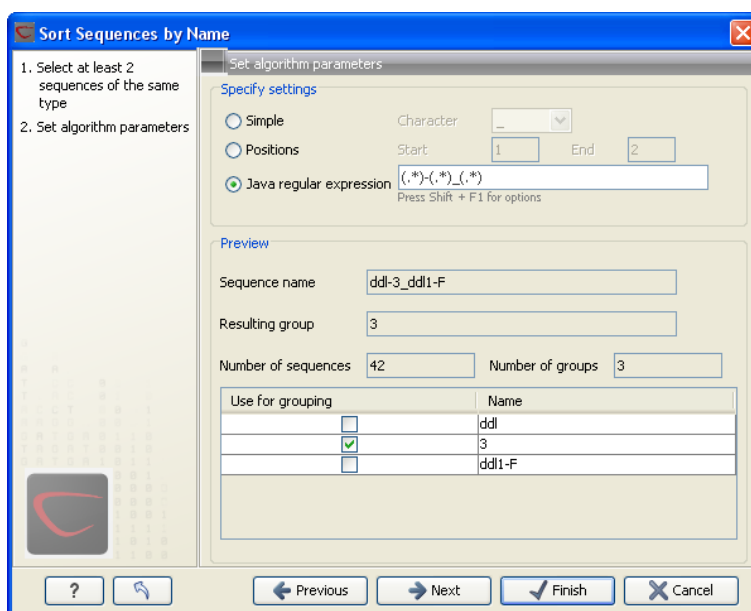

Figure 17.10: Dividing the sequence into three groups based on the number in the middle of the name.

17.6 Add sequences to an existing contig

This section describes how to assemble sequences to an existing contig. This feature can be used for example to provide a steady work-flow when a number of exons from the same gene are sequenced one at a time and assembled to a reference sequence.

Note that the new sequences will be added to the existing contig which will not be extended. If the new sequences extend beyond the existing contig, they will be cut off.

To start the assembly:

Toolbox in the Menu Bar | Molecular Biology Tools (🔧) | Sequencing Data Analysis (🔍) | Add Sequences to Contig (📁)

or **right-click in the empty white area of the contig | Add Sequences to Contig (📁)**

This opens a dialog where you can select one contig and a number of sequences to assemble. If you have already selected sequences in the Navigation Area, these will be shown in the 'Selected Elements' box. However, you can remove these, or add others, by using the arrows to move sequences between the Navigation Area and Selected Elements boxes. You can also add sequence lists.

Often, the results of the assembly will be better if the sequences are trimmed first (see section 17.2.1).

When the elements are selected, click **Next**, and you will see the dialog shown in figure 17.11

The options in this dialog are similar to the options that are available when assembling to a reference sequence (see section 17.4).

Click **Next** if you wish to adjust how to handle the results (see section 8.2). If not, click **Finish**. This will start the assembly process. See section 17.7 on how to use the resulting contig.

Note that the new sequences will be added to the existing contig which will not be extended. If

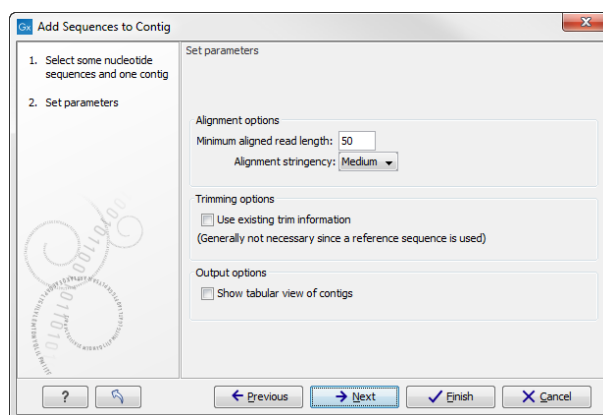

Figure 17.11: Setting assembly parameters when assembling to an existing contig.

the new sequences extend beyond the existing contig, they will be cut off.

17.7 View and edit contigs and read mappings

The results of the assembly or mapping (assembly to a reference) are respectively contigs or a read mapping. In both cases the sequence reads have been aligned (see figure 17.12). If multiple reference sequences were used, this information will be in a table where the actual visual mapping can be opened by double-clicking.

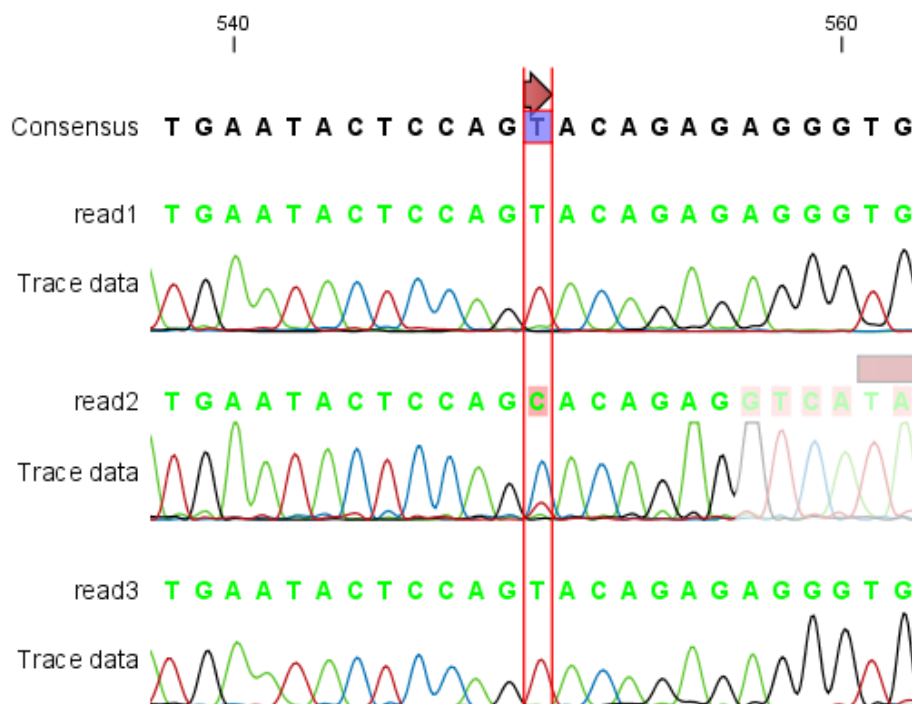

Figure 17.12: The view of a contig. Notice that you can zoom to a very detailed level.

You can see that color of the residues and trace at the end of one of the reads has been faded. This indicates, that this region has not contributed to the contig or mapping. This may be due to trimming before or during the assembly or due to misalignment to the other reads.

You can easily adjust the trimmed area to include more of the read in the contig or mapping:

simply drag the edge of the faded area as shown in figure 17.13.



Figure 17.13: Dragging the edge of the faded area.

Note! This is only possible when you can see the residues on the reads. This means that you need to have zoomed in to 100% or more and chosen **Compactness** levels "Not compact", "Low" or "Packed". Otherwise the handles for dragging are not available (this is done in order to make the visual overview more simple).

If reads have been reversed, this is indicated by red. Otherwise, the residues are colored green. The colors can be changed in the **Side Panel** as described in section 17.7.1

If you find out that the reversed reads should have been the forward reads and vice versa, you can reverse complement the whole contig or mapping. Right-click in the empty white area of the contig or mapping and choose to **Reverse Complement Sequence**.

17.7.1 View settings in the Side Panel

The View Settings panel for assemblies and read mappings with fewer than 2000 reads resembles that of alignments (see section 19.2) but has some extra preferences described below (figure 17.14).

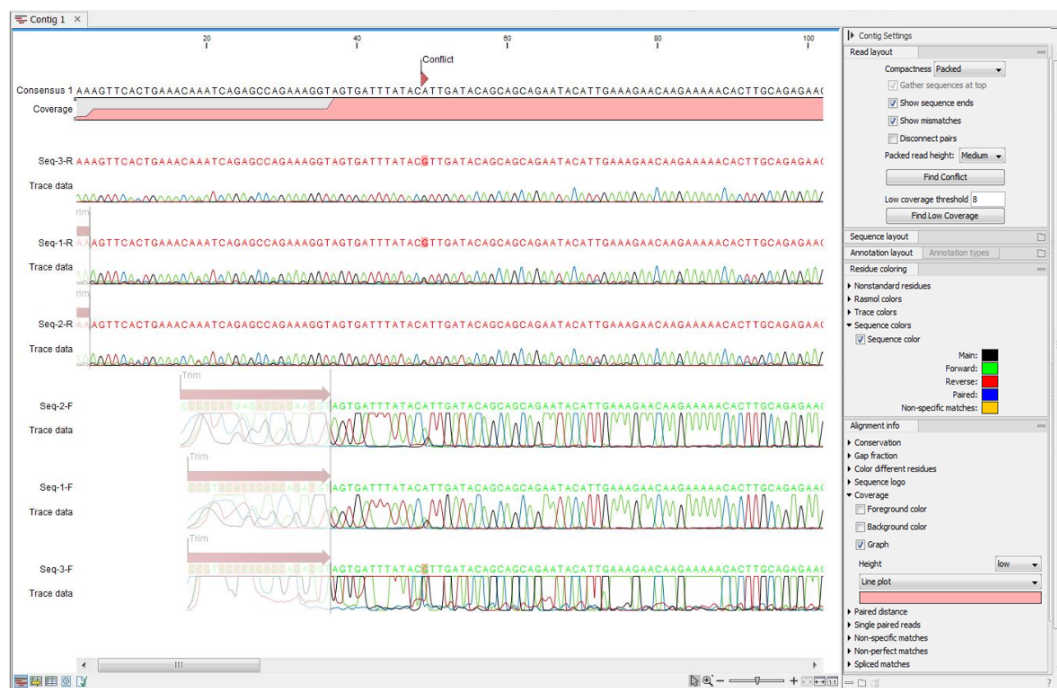

Figure 17.14: An example of contig, result of an assembly with less than 2000 reads

- **Read layout.** This section appears at the top of the **Side Panel** when viewing a stand alone read mapping:
 - **Compactness.** The compactness setting options let you control the level of detail to be displayed. This setting affects many of the other settings in the **Side Panel** as well as the general behavior of the view. For example: if the compactness is set to **Compact**, you will not be able to see quality scores or annotations on the reads, even if these are turned on via the Nucleotide info section of the Side Panel. You can change the Compactness setting in the Side Panel directly, or you can use the shortcut: press and hold the Alt key while you scroll with the mouse wheel or touchpad.
 - * **Not compact.** This allows the mapping to be viewed in full detail, including quality scores and trace data for the reads, where this is relevant. To view such information, additional viewing options under the **Nucleotide info** view settings must also be selected. For further details on these, please see section [17.1.2](#) and section [10.1](#).
 - * **Low.** Hides trace data, quality scores and puts the reads' annotations on the sequence.
 - * **Medium.** The labels of the reads and their annotations are hidden, and the residues of the reads cannot be seen.
 - * **Compact.** Even less space between the reads.
 - * **Packed.** All the other compactness settings will stack the reads on top of each other, but the packed setting will use all space available for displaying the reads. When zoomed in to 100%, you can see the residues but when zoomed out the reads will be represented as lines just as with the Compact setting. The packed mode is very useful when viewing large amounts of data. However certain functionality possible with other views are not available in packed view. For example, no editing of the read mapping or selections of it can be done and color coding changes are not possible.
 - **Gather sequences at top.** Enabling this option affects the view that is shown when scrolling horizontally. If selected, the sequence reads which did not contribute to the visible part of the mapping will be omitted whereas the contributing sequence reads will automatically be placed right below the reference. This setting is not relevant when the compactness is packed.
 - **Show sequence ends.** Regions that have been trimmed are shown with faded traces and residues. This illustrates that these regions have been ignored during the assembly.
 - **Show mismatches.** When the compactness is packed, you can highlight mismatches which will get a color according to the Rasmol color scheme. A mismatch is whenever the base is different from the reference sequence at this position. This setting also causes the reads that have mismatches to be floated at the top of the view.
 - **Disconnect pairs.** This option will break up the paired reads in the display (they are still marked as pairs - this just affects the visualization). The reads are marked with colors for the direction (default red and green) instead of the color for pairs (default blue). This is particularly useful when investigating overlapping pairs in packed view and when the strand / read orientation is important.
 - **Packed read height.** When the compactness is set to "packed", you can choose the height of the visible reads. When there are more reads than the height specified, an

overflow graph will be displayed below the reads. The overflow graph is shown in the same colors as the sequences, and mismatches in reads are shown as narrow vertical lines. The colors of the small lines represent the mismatching residue. The color codes for the horizontal lines correspond to the color used for highlighting mismatches in the sequences (red = A, blue = C, yellow = G, and green = T), meaning that a red line with half the height of the blue part of the overflow graph will represent a mismatching "A" in half of the paired reads at this particular position.

- **Find Conflict.** Clicking this button selects the next position where there is an conflict between the sequence reads. Residues that are different from the reference are colored (as default), providing an overview of the conflicts. Since the nextF conflict is automatically selected it is easy to make changes. You can also use the Space key to find the next conflict.
 - **Low coverage threshold.** All regions with coverage up to and including this value are considered low coverage. When clicking the 'Find low coverage' button the next region in the read mapping with low coverage will be selected.
- **Alignment info.** There is one additional parameter:
 - **Coverage:** Shows how many sequence reads that are contributing information to a given position in the mapping. The level of coverage is relative to the overall number of sequence reads.
 - * **Foreground color.** Colors the letters using a gradient, where the left side color is used for low coverage and the right side is used for maximum coverage.
 - * **Background color.** Colors the background of the letters using a gradient, where the left side color is used for low coverage and the right side is used for maximum coverage
 - * **Graph.** The coverage is displayed as a graph (Learn how to export the data behind the graph in section 6.7).
 - **Height.** Specifies the height of the graph.
 - **Type.** The graph can be displayed as Line plot, Bar plot or as a Color bar.
 - **Color box.** For Line and Bar plots, the color of the plot can be set by clicking the color box. If a Color bar is chosen, the color box is replaced by a gradient color box as described under Foreground color.
 - **Residue coloring.** There is one additional parameter:
 - **Sequence colors.** This option lets you use different colors for the reads.
 - * **Main.** The color of the consensus and reference sequence. Black per default.
 - * **Forward.** The color of forward reads (single reads). Green per default.
 - * **Reverse.** The color of reverse reads (single reads). Red per default.
 - * **Paired.** The color of paired reads. Blue per default. Note that reads from **broken pairs** are colored according to their Forward/Reverse orientation or as a Non-specific match, but with a darker nuance than ordinary single reads.
 - * **Non-specific matches.** When a read would have matched equally well another place in the mapping, it is considered a non-specific match. This color will "override" the other colors. Note that if you are mapping with several reference sequences, a read is considered a double match when it matches more than once *across all the contigs/references*. A non-specific match is yellow per default.

- **Sequence layout.**

- **Matching residues as dots** Matching residues will be presented as dots. Only the top sequence will be preserved in its original format.

There are many other viewing options available, both general and aimed at specific elements of a contig or a mapping, which can be adjusted in the View settings. Those covered here were the key ones relevant for standard review of the results.

17.7.2 Editing a contig or read mapping

When editing contigs and read mappings, you are typically interested in confirming or changing single bases, and this can be done simply by:

selecting the base | typing the right base

Some users prefer to use lower-case letters in order to be able to see which bases were altered when they use the results later on. In *CLC Genomics Workbench* all changes are recorded in the history log (see section 2.1.2) allowing the user to quickly reconstruct the actions performed in the editing session.

There are three shortcut keys for easily finding the positions where there are conflicts:

- Space bar: Finds the *next* conflict.
- "." (punctuation mark key): Finds the *next* conflict.
- "," (comma key): Finds the *previous* conflict.

In the contig or mapping view, you can use **Zoom in**  to zoom to a greater level of detail than in other views (see figure 17.12). This is useful for discerning the trace curves.

If you want to replace a residue with a gap, use the **Delete** key.

If you wish to edit a selection of more than one residue:

right-click the selection | Edit Selection ()

This will show a warning dialog, but you can choose never to see this dialog again by clicking the checkbox at the bottom of the dialog.

Note that for contigs or mappings with more than 1000 reads, you can only do single-residue replacements (you can't delete or edit a selection). When the compactness is **Packed**, you cannot edit any of the reads.

17.7.3 Sorting reads

If you wish to change the order of the sequence reads, simply drag the label of the sequence up and down. Note that this is not possible if you have chosen **Gather sequences at top** or set the compactness to **Packed** in the **Side Panel**.



You can also sort the reads by right-clicking a sequence label and choose from the following options:

- **Sort Reads by Alignment Start Position.** This will list the first read in the alignment at the top etc.
- **Sort Reads by Name.** Sort the reads alphabetically.
- **Sort Reads by Length.** The shortest reads will be listed at the top.

17.7.4 Read conflicts

After assembly or mapping, conflicts between the reads are annotated on the consensus sequence. The definition of a conflict is *a position where at least one of the reads have a different residue*.

A conflict can be in two states:

- **Conflict.** Both the annotation and the corresponding row in the Table  are colored **red**.
- **Resolved.** Both the annotation and the corresponding row in the Table  are colored **green**.

The conflict can be resolved by correcting the deviating residues in the reads as described above.

A fast way of making all the reads reflect the consensus sequence is to select the position in the consensus, right-click the selection, and choose **Transfer Selection to All Reads**.

The opposite is also possible: make a selection on one of the reads, right click, and **Transfer Selection to Contig Sequence**.

17.7.5 Using the mapping

Due to the integrated nature of *CLC Genomics Workbench* it is easy to use the consensus sequences as input for additional analyses. If you wish to extract the consensus sequence for further use, use the **Extract Consensus Sequence** tool (see section 24.8).

You can also right-click the consensus sequence and select **Open Sequence**. This will not create a new sequence but simply let you see the sequence in a sequence view. This means that the sequence still "belong" to the mapping and will be saved together with the mapping. It also means that if you add annotations to the sequence, they will be shown in the mapping view as well. This can be very convenient e.g. for Primer design .

If you wish to BLAST the consensus sequence, simply select the whole contig for your BLAST search. It will automatically extract the consensus sequence and perform the BLAST search.

In order to preserve the history of the changes you have made to the contig, the contig itself should be saved from the contig view, using either the save button  or by dragging it to the **Navigation Area**.

17.7.6 Extract parts of a mapping

Sometimes it is useful to extract part of a mapping for in-depth analysis. This could be the case if you have performed an analysis of a whole genome data set and have found a region that you are particularly interested in analyzing further. Rather than running all further analysis on your

full data, you may prefer to run only on a subset of the data. You can extract a subset of your mapping data by running the **Extract from Selection** tool on a selected region in your mapping. The result of running this tool is a new mapping which contains only the reads (and optionally only those that are of a particular type) in your selected region.

To select a region, use the **Selection mode** () (see Section 2.2.3 for a detailed description of the different modes) and select your region of interest in your mapping, then right-click. You are now presented with the dialog shown in figure 17.15.

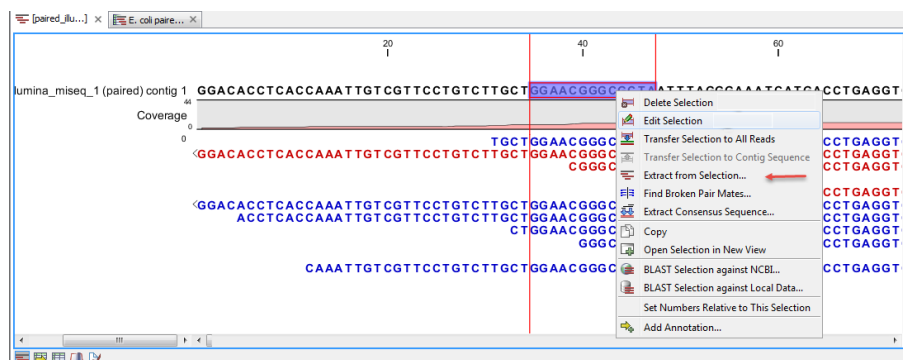

Figure 17.15: Extracting parts of a mapping.

When you choose the **Extract from Selection** option you are presented by the dialog shown in figure 17.16.

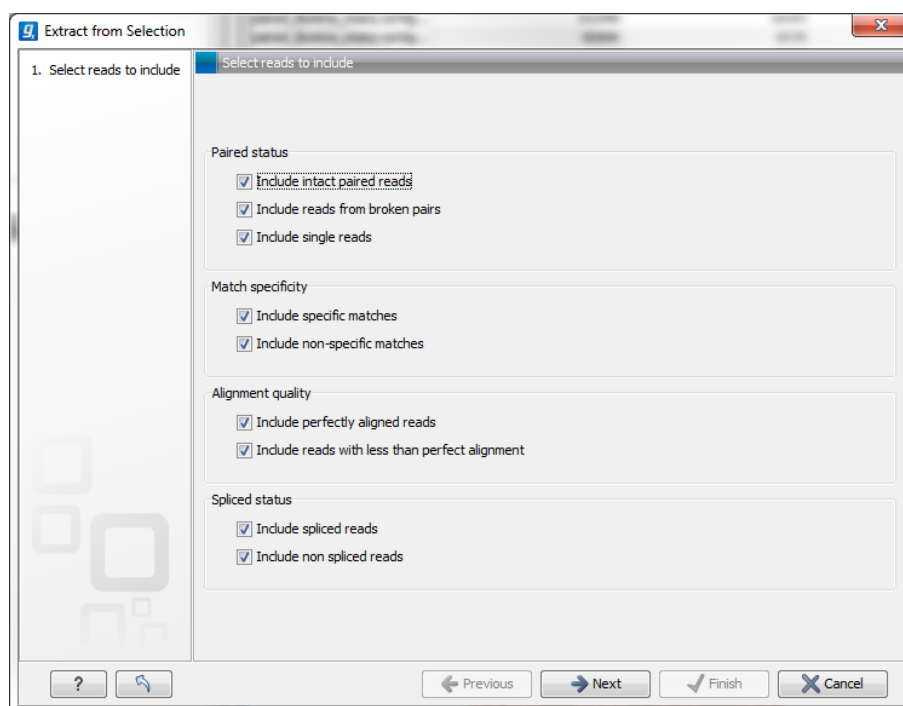

Figure 17.16: Selecting the reads to include.

The purpose of this dialog is to let you specify what kind of reads you want to include. Per default all reads are included. The options are:

Paired status Include intact paired reads When paired reads are placed within the paired distance specified, they will fall into this category. Per default, these reads are colored in

blue.

Include paired reads from broken pairs When a pair is broken, either because only one read in the pair matches, or because the distance or relative orientation is wrong, the reads are placed and colored as single reads, but you can still extract them by checking this box.

Include single reads This will include reads that are marked as single reads (as opposed to paired reads). Note that paired reads that have been broken during assembly are not included in this category. Single reads that come from trimming paired sequence lists are included in this category.

Match specificity Include specific matches Reads that only are mapped to one position.

Include non-specific matches Reads that have multiple equally good alignments to the reference. These reads are colored yellow per default.

Alignment quality Include perfectly aligned reads Reads where *the full read* is perfectly aligned to the reference sequence (or consensus sequence for de novo assemblies). Note that at the end of the contig, reads may extend beyond the contig (this is not visible unless you make a selection on the read and observe the position numbering in the status bar). Such reads are not considered perfectly aligned reads because they don't align in their entire length.

Include reads with less than perfect alignment Reads with mismatches, insertions or deletions, or with unaligned nucleotides at the ends (the faded part of a read).

Spliced status Include spliced reads Reads that are across an intron.

Include non spliced reads Reads that are not across an intron.

Note that only reads that are completely covered by the selection will be part of the new contig.

One of the benefits of this is that you can actually use this tool to extract subset of reads from a contig. An example work flow could look like this:

1. Select the whole reference sequence
2. Right-click and **Extract from Selection**
3. Choose to include only paired matches
4. Extract the reads from the new file (see section [13.2](#))

You will now have all paired reads from the original mapping in a list.

17.7.7 Variance table

In addition to the standard graphical display of a contig or mapping as described above, you can also see a tabular overview of the conflicts between the reads by clicking the **Table**  icon at the bottom of the view.

This will display a new view of the conflicts as shown in figure [17.17](#).

The table has the following columns:

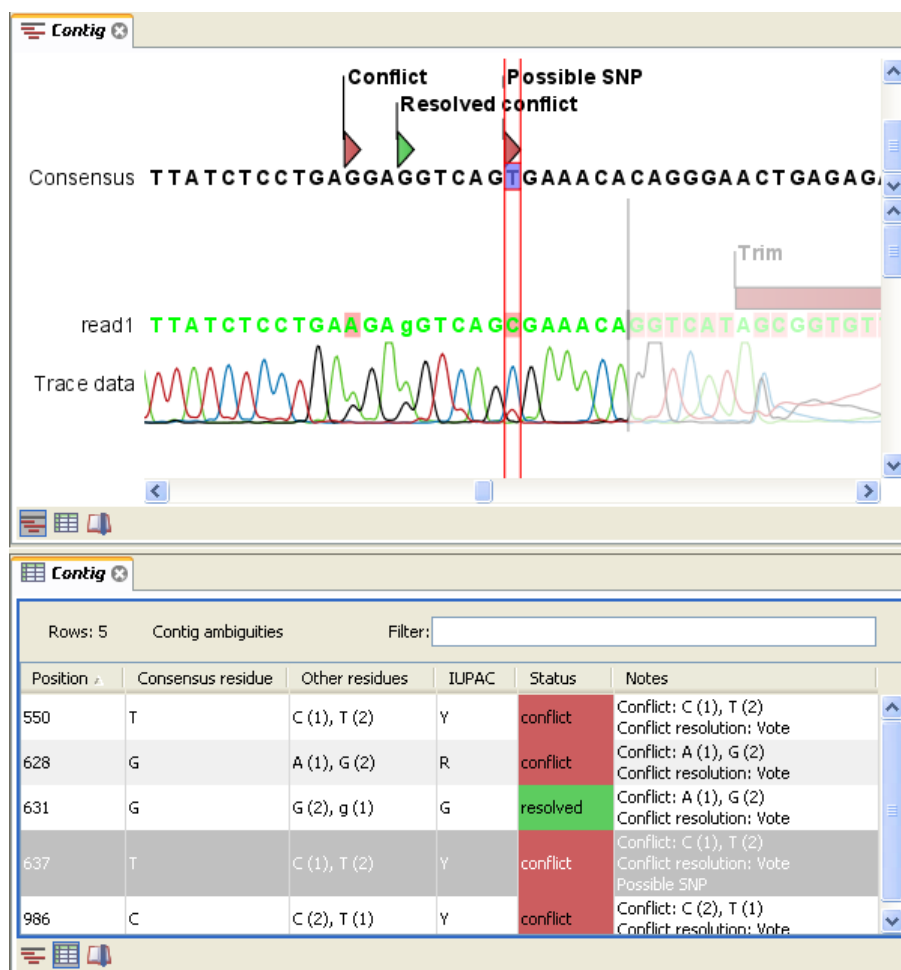

Figure 17.17: The graphical view is displayed at the top. At the bottom the conflicts are shown in a table. At the conflict at position 637, the user has entered a comment in the table. This comment is now also reflected on the tooltip of the conflict annotation in the graphical view above.

- **Reference position.** The position of the conflict measured from the starting point of the reference sequence.
- **Consensus position.** The position of the conflict measured from the starting point of the consensus sequence.
- **Consensus residue.** The consensus's residue at this position. The residue can be edited in the graphical view, as described above.
- **Other residues.** Lists the residues of the reads. Inside the brackets, you can see the number of reads having this residue at this position. In the example in figure 17.17, you can see that at position 637 there is a 'C' in the top read in the graphical view. The other two reads have a 'T'. Therefore, the table displays the following text: 'C (1), T (2)'.
- **IUPAC.** The ambiguity code for this position. The ambiguity code reflects the residues in the reads - not in the consensus sequence. (The IUPAC codes can be found in section H.)
- **Status.** The status can either be conflict or resolved:

- **Conflict.** Initially, all the rows in the table have this status. This means that there is one or more differences between the sequences at this position.
- **Resolved.** If you edit the sequences, e.g. if there was an error in one of the sequences, and they now all have the same residue at this position, the status is set to *Resolved*.
- **Note.** Can be used for your own comments on this conflict. Right-click in this cell of the table to add or edit the comments. The comments in the table are associated with the conflict annotation in the graphical view. Therefore, the comments you enter in the table will also be attached to the annotation on the consensus sequence (the comments can be displayed by placing the mouse cursor on the annotation for one second - see figure 17.17). The comments are saved when you **Save** (↵).

By clicking a row in the table, the corresponding position is highlighted in the graphical view. Clicking the rows of the table is another way of navigating the contig or the mapping, as are using the **Find Conflict** button or using the **Space bar**. You can use the up and down arrow keys to navigate the rows of the table.

17.8 Reassemble contig

If you have edited a contig, changed trimmed regions, or added or removed reads, you may wish to reassemble the contig. This can be done in two ways:

Toolbox | Molecular Biology Tools (🔧) | Sequencing Data Analysis (🔍) | Reassemble Contig (🔄) | select the contig from Navigation Area, move to 'Selected Elements' and click Next

or **right-click in the empty white area of the contig | Reassemble contig (🔄)**

This opens a dialog as shown in figure 17.18

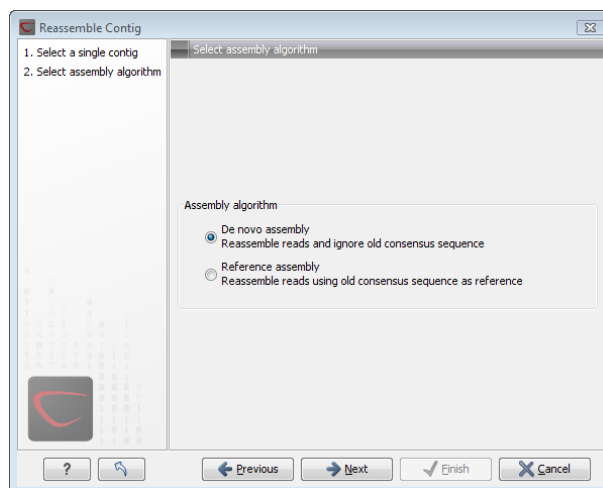

Figure 17.18: Re-assembling a contig.

In this dialog, you can choose:

- **De novo assembly.** This will perform a normal assembly in the same way as if you had selected the reads as individual sequences. When you click **Next**, you will follow the same steps as described in section 17.3. The consensus sequence of the contig will be ignored.

- **Reference assembly.** This will use the consensus sequence of the contig as reference. When you click **Next**, you will follow the same steps as described in section 17.4.

When you click **Finish**, a new contig is created, so you do not lose the information in the old contig.

17.9 Secondary peak calling

CLC Genomics Workbench is able to detect secondary peaks - a peak within a peak - to help discover heterozygous mutations. Looking at the height of the peak below the top peak, the CLC Genomics Workbench considers all positions in a sequence, and if a peak is higher than the threshold set by the user, it will be "called".

The peak detection investigates any secondary high peaks in the same interval as the already called peaks. The peaks must have a peak shape in order to be considered (i.e. a fading signal from the previous peak will be ignored). **Note!** The secondary peak caller does not call and annotate secondary peaks that have already been called by the Sanger sequencing machine and denoted with an ambiguity code.

Regions that are trimmed (i.e. covered by trim annotations) are ignored in the analysis (section 17.2).

When a secondary peak is called, the residue is change to an ambiguity character to reflect that two bases are possible at this position, and optionally an annotation is added at this position.

To call secondary peaks:

Toolbox | Molecular Biology Tools (M) | Sequencing Data Analysis (A) | Call Secondary Peaks (A)

This opens a dialog where you can add the sequences to be analyzed. If you had already selected sequence in the Navigation Area, these will be shown in the 'Selected Elements' box. However you can remove these, or add others, by using the arrows to move sequences between the Navigation Area and Selected Elements boxes.

When the sequences are selected, click **Next**.

This opens the dialog displayed in figure 17.19.

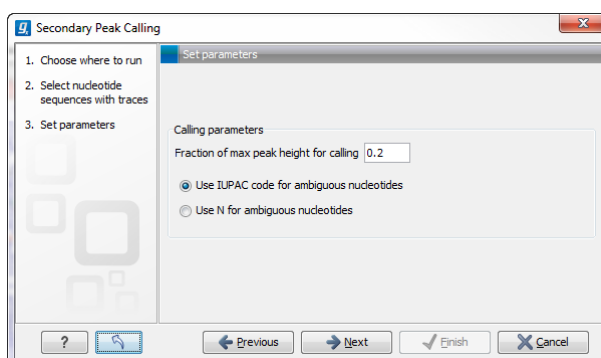

Figure 17.19: Setting parameters secondary peak calling.

The following parameters can be adjusted in the dialog:

- **Fraction of max peak height for calling.** Adjust this value to specify how high the secondary peak must be to be called.
- **Use IUPAC code / N for ambiguous nucleotides.** When a secondary peak is called, the residue at this position can either be replaced by an N or by a ambiguity character based on the IUPAC codes (see section [H](#)).

Clicking **Next** allows you to add annotations. In addition to changing the actual sequence, annotations can be added for each base that has been called. The annotations hold information about the fraction of the max peak height.

Click **Next** if you wish to adjust how to handle the results (see section [8.2](#)). If not, click **Finish**. This will start the secondary peak calling. A detailed history entry will be added to the history specifying all the changes made to the sequence.

Chapter 18

Cloning and cutting

Contents

18.1 Molecular cloning	428
18.1.1 Introduction to the cloning editor	429
18.1.2 The cloning workflow	430
18.1.3 Manual cloning	433
18.1.4 Insert restriction site	438
18.2 Gateway cloning	438
18.2.1 Add attB sites	439
18.2.2 Create entry clones (BP)	444
18.2.3 Create expression clones (LR)	445
18.3 Restriction site analysis	447
18.3.1 Dynamic restriction sites	447
18.3.2 Restriction site analysis from the Toolbox	454
18.4 Gel electrophoresis	460
18.4.1 Separate fragments of sequences on gel	461
18.4.2 Separate sequences on gel	461
18.4.3 Gel view	461
18.5 Restriction enzyme lists	463
18.5.1 Create enzyme list	463
18.5.2 View and modify enzyme list	465

CLC Genomics Workbench offers graphically advanced *in silico* cloning and design of vectors for various purposes together with restriction enzyme analysis and functionalities for managing lists of restriction enzymes.

First, after a brief introduction, restriction cloning and general vector design is explained. Next, we describe how to do Gateway Cloning ¹. Finally, the general restriction site analyses are described.

¹Gateway is a registered trademark of Invitrogen Corporation

18.1 Molecular cloning

Molecular cloning is a very important tool in the quest to understand gene function and regulation. Through molecular cloning it is possible to study individual genes in a controlled environment. Using molecular cloning it is possible to build complete libraries of fragments of DNA inserted into appropriate cloning vectors.

The *in silico* cloning process in *CLC Genomics Workbench* begins with the selection of sequences to be used:

Toolbox | Molecular Biology Tools (🔧) | Cloning and Restriction Sites (🧬) | Cloning (🔍)

This will open a dialog where you can select the sequences containing the fragments you want to clone as well as sequences to be used as vector (figure 18.1).

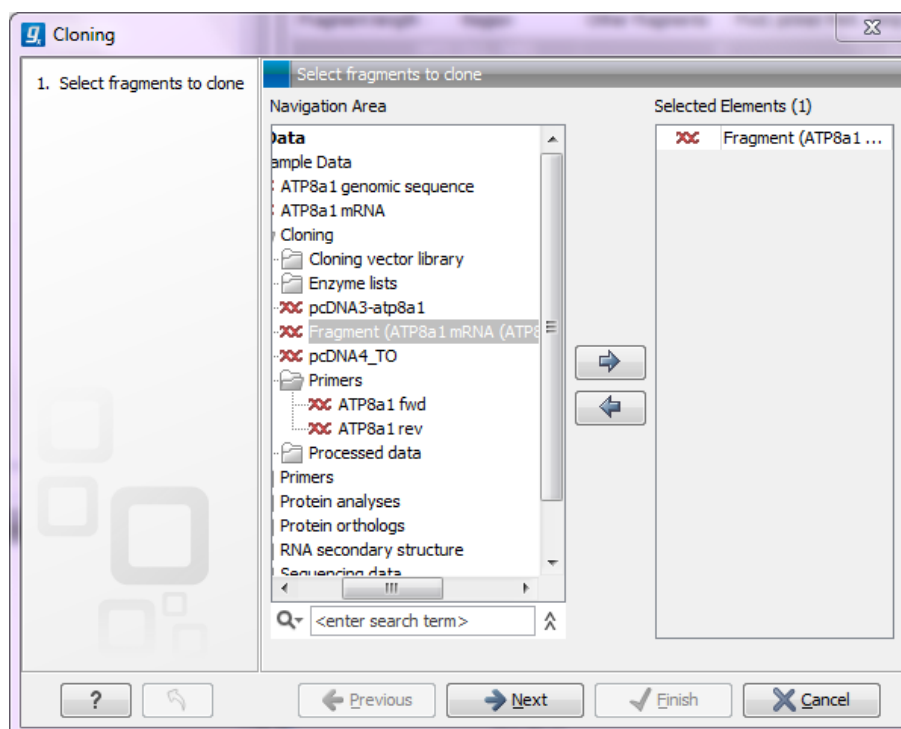

Figure 18.1: Selecting one or more sequences containing the fragments you want to clone.

The *CLC Genomics Workbench* will now create a sequence list of the selected fragments and vector sequences (if you have selected both fragments and vectors) and open it in the cloning editor as shown in figure 18.2.

When you save the cloning experiment, it is saved as a **Sequence list**. See section 10.6 for more information about sequence lists. If you need to open the list later for cloning work, simply switch to the **Cloning** (🔍) editor at the bottom of the view.

If you later in the process need additional sequences, you can easily add more sequences to the view. Just:

right-click anywhere on the empty white area | Add Sequences

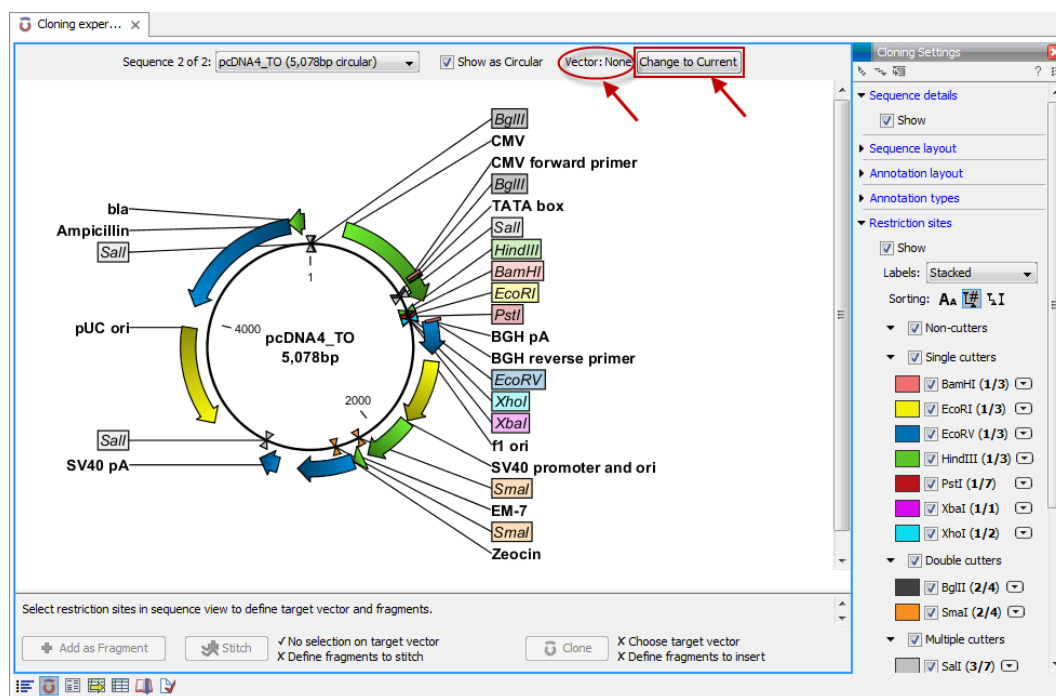

Figure 18.2: Cloning editor.

18.1.1 Introduction to the cloning editor



In the cloning editor, most of the basic options for viewing, selecting and zooming the sequences are the same as for the standard sequence view. See section 10.1 for an explanation of these options. This means that e.g. known SNP's, exons and other annotations can be displayed on the sequences to guide the choice of regions to clone.

However, the cloning editor has a special layout with three distinct areas (in addition to the **Side Panel** found in other sequence views as well):

- At the top, there is a panel to switch between the sequences selected as input for the cloning. You can also specify whether the sequence should be visualized **as circular** or as a fragment. At the right-hand side, you can select whether or not to select a vector. When no vector has been selected a button **Change to Current** is enabled. This button can be used to select the currently shown sequence as **vector**.
- In the middle, the selected sequence is shown. This is the central area for defining how the cloning should be performed. This is explained in details below.
- At the bottom, there is a panel where the selection of fragments and target vector is performed (see elaboration below).

There are essentially three ways of performing cloning in the *CLC Genomics Workbench*. The *first* is the most straight-forward approach, which is based on a simple model of selecting restriction sites for cutting out one or more fragments and defining how to open the vector to insert the fragments. This is described as *the cloning workflow* below. The *second* approach is unguided and more flexible and allows you to manually cut, copy, insert and replace parts of the sequences. This approach is described under *manual cloning* below. *Finally*, the *CLC Genomics Workbench* also supports *Gateway cloning* (see section 18.2).

The cloning editor

The cloning editor can be activated in different ways. One way is to click on the **Cloning Editor** icon () in the view area when a sequence list has been opened in the sequence list editor. Another way is to create a new cloning experiment (the actual data object will still be a sequence list) using the **Cloning** () action from the toolbox. Using this action the user collects a set of existing sequences and creates a new sequence list.

The cloning editor can be used in two different ways:

1. **The cloning mode** is utilized when the user has selected one of the sequences as 'Vector'. In the cloning mode, the user opens up the vector by applying one or more cuts to the vector, thereby creating an opening for insertion of other sequence fragments. From the remaining sequences in the cloning experiment/sequence list, either complete sequences or fragments created by cutting can be inserted into the vector. In the cloning adapter dialog, the user can switch the order of the inserted fragments and rotate them prior to adjusting the overhangs to match the cloning conditions.
2. **The stitch mode** is utilized when the user deselects or has not selected a sequence as 'Vector'. In stitch mode, the user can select a number of fragments (either full sequences or cuttings) from the cloning experiment. These fragments can then be stitched together into one single new and longer sequence. In the stitching adapter dialog, the user can switch order and rotate the fragments prior to adjusting the overhangs to match the stitch conditions.

18.1.2 The cloning workflow

The *cloning workflow* is designed to support restriction cloning workflows through the following steps:

1. Define one or more fragments
2. Define how the vector should be opened
3. Specify orientation and order of the fragment

Defining fragments

First, select the sequence containing the cloning fragment in the list at the top of the view. Next, make sure the restriction enzyme you wish to use is listed in the **Side Panel** (see section 18.3.1). To specify which part of the sequence should be treated as the fragment, first click one of the cut sites you wish to use. Then press and hold the Ctrl key (⌘ on Mac) while you click the second cut site. You can also right-click the cut sites and use the **Select This ... Site** to select a site.

When this is done, the panel below will update to reflect the selections (see figure 18.3).

In this example you can see that there are now two options listed in the panel below the view. This is because there are now two options for selecting the fragment that should be used for cloning. The fragment selected per default is the one that is in between the cut sites selected.

If the entire sequence should be selected as fragment, click the **Add Current Sequence as Fragment** ().

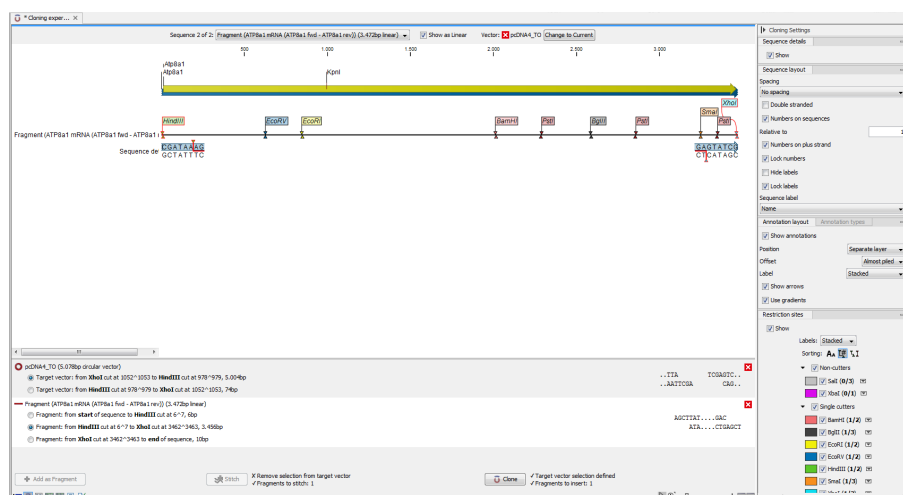

Figure 18.3: *HindIII* and *XhoI* cut sites selected to cut out fragment.

At any time, the selection of cut sites can be cleared by clicking the **Remove** (✖) icon to the right of the fragment selections. If you just wish to remove the selection of one of the sites, right-click the site on the sequence and choose **De-select This ... Site**.

Defining target vector

When selecting among the sequences in the panel at the top, the vector sequence has "vector" appended to its name. If you wish to use one of the other sequences as vector, select this sequence in the list and click **Change to Current**.

The next step is to define where the vector should be cut. If the vector sequence should just be opened, click the restriction site you want to use for opening. If you want to cut off part of the vector, click two restriction sites while pressing the Ctrl key (⌘ on Mac). You can also right-click the cut sites and use the **Select This ... Site** to select a site.

This will display two options for what the target vector should be (for linear vectors there would have been three option) (figure 18.4).

Just as when cutting out the fragment, there is a lot of choices regarding which sequence should be used as the vector.

At any time, the selection of cut sites can be cleared by clicking the **Remove** (✖) icon to the right of the target vector selections. If you just wish to remove the selection of one of the sites, right-click the site on the sequence and choose **De-select This ... Site**.

When the right target vector is selected, you are ready to **Perform Cloning** (🔗), see below.

Perform cloning

Once selections have been made for both fragments and vector, click **Cloning** (🔗). This will display a dialog to adapt overhangs and change orientation as shown in figure 18.5)

This dialog visualizes the details of the insertion. The vector sequence is on each side shown in a faded gray color. In the middle the fragment is displayed. If the overhangs of the sequence and the vector do not match, you can blunt end or fill in the overhangs using the **drag handles** (⏏).

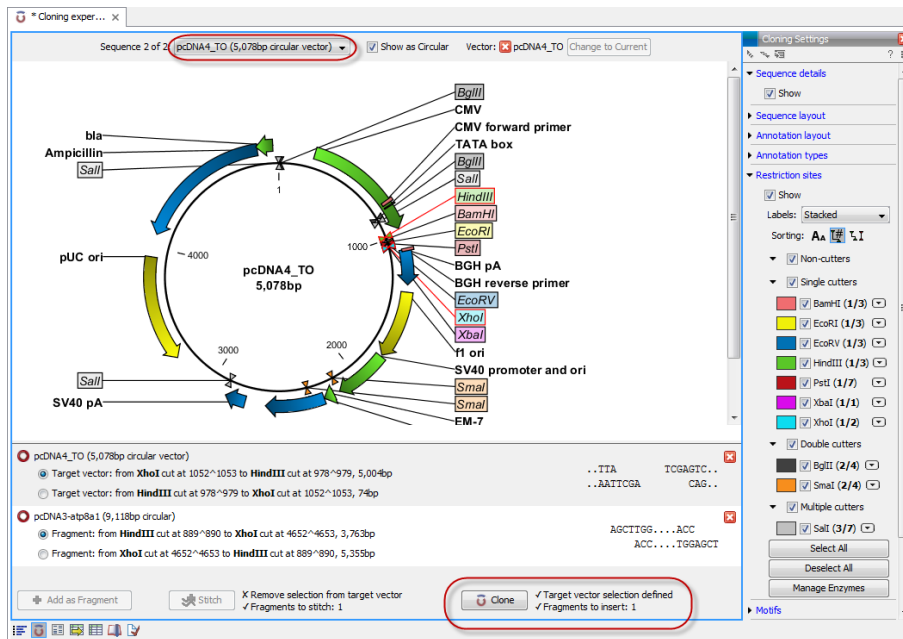

Figure 18.4: *HindIII* and *XhoI* sites used to open the vector. Note that the "Cloning" button has now been enabled as both criteria ("Target vector selection defined" and "Fragments to insert:...") have been defined.

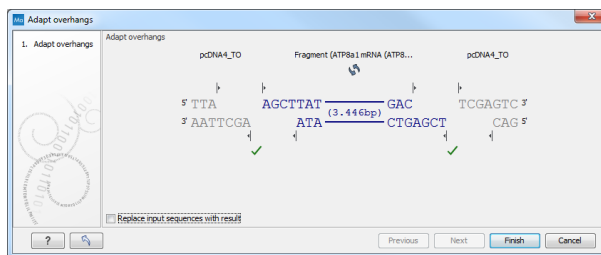

Figure 18.5: Showing the insertion point of the vector.

Click and drag with the mouse to adjust the overhangs.

Whenever you drag the handles, the status of the insertion point is indicated below:

- The overhangs match (✓).
- The overhangs do not match (⊘). In this case, you will not be able to click **Finish**. Drag the handles to make the overhangs match.

The fragment can be reverse complemented by clicking the **Reverse complement fragment** (↻).

When several fragments are used, the order of the fragments can be changed by clicking the move buttons (⇨)/(⇩).

There is an option for the result of the cloning: **Replace input sequences with result**. Per default, the construct will be opened in a new view and can be saved separately. By selecting this option, the construct will also be added to the input sequence list and the original fragment and vector sequences will be deleted.

When you click **Finish** the final construct will be shown (see figure 18.6).

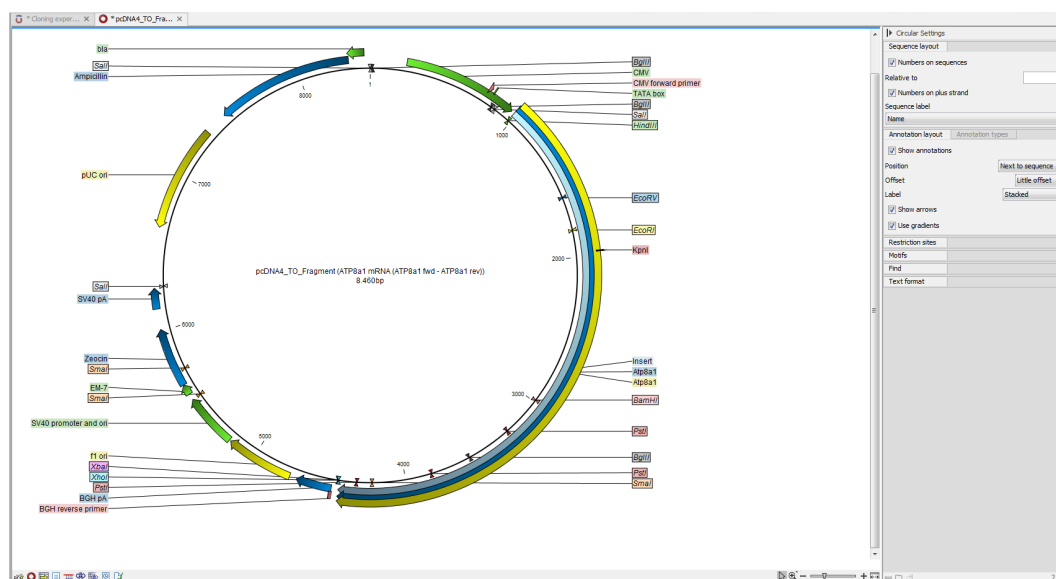

Figure 18.6: *The final construct.*

You can now **Save** (⌘) this sequence for later use. The cloning experiment used to design the construct can be saved as well. If you check the **History** (🕒) of the construct, you can see the details about restriction sites and fragments used for the cloning.

18.1.3 Manual cloning

If you wish to use the manual way of cloning (as opposed to using the cloning workflow explained above in section 18.1.2), you can disregard the panel at the bottom. The manual cloning approach is based on a number of ways that you can manipulate the sequences. All manipulations of sequences are done manually, giving you full control over how the final construct is made. Manipulations are performed through right-click menus, which have three different appearances depending on where you click, as visualized in figure 18.7.

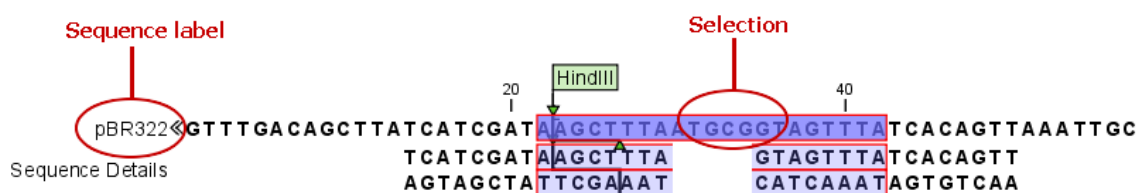

Figure 18.7: *The red circles mark the two places you can use for manipulating the sequences.*

- **Right-click the sequence name (to the left) to manipulate the whole sequence.**
- **Right-click a selection to manipulate the selection.**

The two menus are described in the following:

Manipulate the whole sequence

Right-clicking the sequence name at the left side of the view reveals several options on sorting, opening and editing the sequences in the view (see figure 18.8).

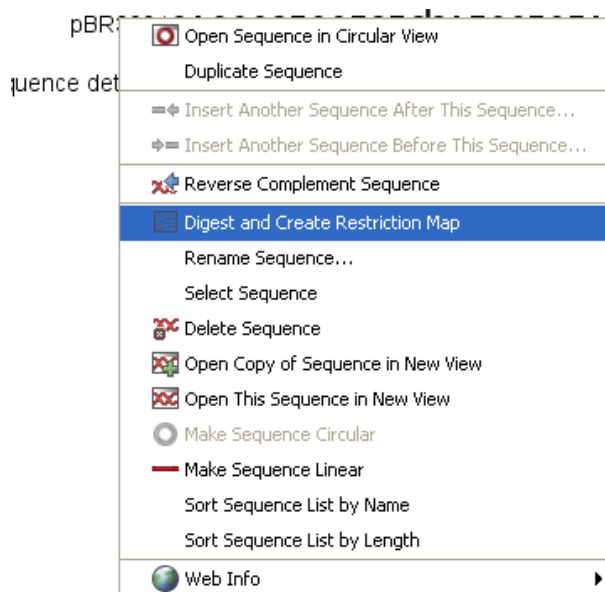

Figure 18.8: Right click on the sequence in the cloning view.

- **Open sequence in circular view** (🔄)

Opens the sequence in a new circular view. If the sequence is not circular, you will be asked if you wish to make it circular or not. (This will not forge ends with matching overhangs together - use "Make Sequence Circular" (🔄) instead.)
- **Duplicate sequence**

Adds a duplicate of the selected sequence. The new sequence will be added to the list of sequences shown on the screen.
- **Insert sequence after this sequence** (➡)

Insert another sequence after this sequence. The sequence to be inserted can be selected from a list which contains the sequences present in the cloning editor. The inserted sequence remains on the list of sequences. If the two sequences do not have blunt ends, the ends' overhangs have to match each other. Otherwise a warning is displayed.
- **Insert sequence before this sequence** (⬅)

Insert another sequence before this sequence. The sequence to be inserted can be selected from a list which contains the sequences present in the cloning editor. The inserted sequence remains on the list of sequences. If the two sequences do not have blunt ends, the ends' overhangs have to match each other. Otherwise a warning is displayed.
- **Reverse sequence**

Reverse the sequence and replaces the original sequence in the list. This is sometimes useful when working with single stranded sequences. Note that this is *not* the same as creating the reverse *complement* (see the following item in the list).
- **Reverse complement sequence** (↔)

Creates the reverse complement of a sequence and replaces the original sequence in the list. This is useful if the vector and the insert sequences are not oriented the same way.
- **Digest Sequence with Selected Enzymes and Run on Gel** (📄)

See section [18.4.1](#)

- **Rename sequence**
Renames the sequence.
- **Select sequence**
This will select the entire sequence.
- **Delete sequence** (✂)
This deletes the given sequence from the cloning editor.
- **Open sequence** (📄)
This will open the selected sequence in a normal sequence view.
- **Make sequence circular** (🔄)
This will convert a sequence from a linear to a circular form. If the sequence have matching overhangs at the ends, they will be merged together. If the sequence have incompatible overhangs, a dialog is displayed, and the sequence cannot be made circular. The circular form is represented by >> and << at the ends of the sequence.
- **Make sequence linear** (—)
This will convert a sequence from a circular to a linear form, removing the << and >> at the ends.

Manipulate parts of the sequence

Right-clicking a selection reveals several options on manipulating the selection (see figure 18.9).

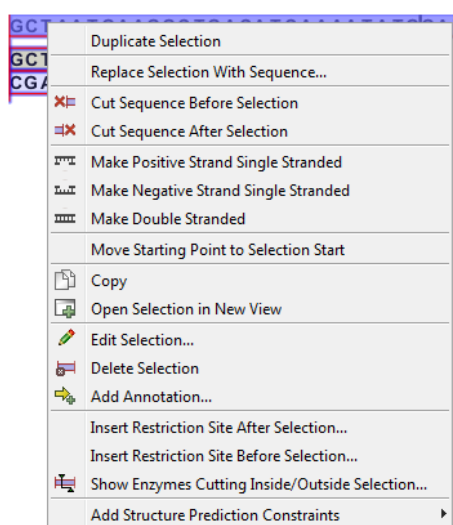













Figure 18.9: Right click on a sequence selection in the cloning view.

- **Duplicate Selection.** If a selection on the sequence is duplicated, the selected region will be added as a new sequence to the cloning editor with a new sequence name representing the length of the fragment. When a sequence region between two restriction sites are double-clicked the entire region will automatically be selected. This makes it very easy to make a new sequence from a fragment created by cutting with two restriction sites (right-click the selection and choose **Duplicate selection**).

- **Replace Selection with sequence.** This will replace the selected region with a sequence. The sequence to be inserted can be selected from a list containing all sequences in the cloning editor.
- **Cut Sequence Before Selection** (). This will cleave the sequence before the selection and will result in two smaller fragments.
- **Cut Sequence After Selection** (). This will cleave the sequence after the selection and will result in two smaller fragments.
- **Make Positive Strand Single Stranded** (). This will make the positive strand of the selected region single stranded.
- **Make Negative Strand Single Stranded** (). This will make the negative strand of the selected region single stranded.
- **Make Double Stranded** (). This will make the selected region double stranded.
- **Move Starting Point to Selection Start.** This is only active for circular sequences. It will move the starting point of the sequence to the beginning of the selection.
- **Copy** (). This will copy the selected region to the clipboard, which will enable it for use in other programs.
- **Open Selection in New View** (). This will open the selected region in the normal sequence view.
- **Edit Selection** (). This will open a dialog box, in which is it possible to edit the selected residues.
- **Delete Selection** (). This will delete the selected region of the sequence.
- **Add Annotation** (). This will open the **Add annotation** dialog box.
- **Insert Restriction Sites After/Before Selection.** This will show a dialog where you can choose from a list restriction enzymes (see section 18.1.4).
- **Show Enzymes Cutting Inside/Outside Selection** (). This will add enzymes cutting this selection to the Side Panel.
- **Add Structure Prediction Constraints.** This is relevant for RNA secondary structure prediction (see section 21.1.4) .

Insert one sequence into another

Sequences can be inserted into each other in several ways as described in the lists above. When you chose to insert one sequence into another you will be presented with a dialog where all sequences in the view are present (see figure 18.10).

The sequence that you have chosen to insert into will be marked with **bold** and the text **[vector]** is appended to the sequence name. Note that this is completely unrelated to the vector concept in the cloning workflow described in section 18.1.2.

The list furthermore includes the length of the fragment, an indication of the overhangs, and a list of enzymes that are compatible with this overhang (for the left and right ends, respectively).

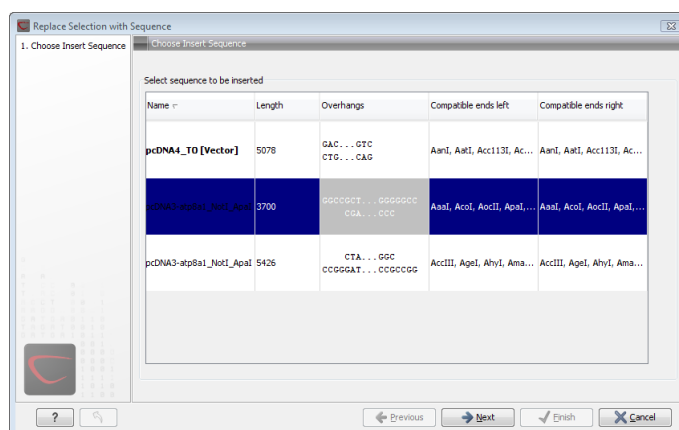

Figure 18.10: Select a sequence for insertion.

If not all the enzymes can be shown, place your mouse cursor on the enzymes, and a full list will be shown in the tool tip.

Select the sequence you wish to insert and click **Next**.

This will show the dialog in figure 18.11).

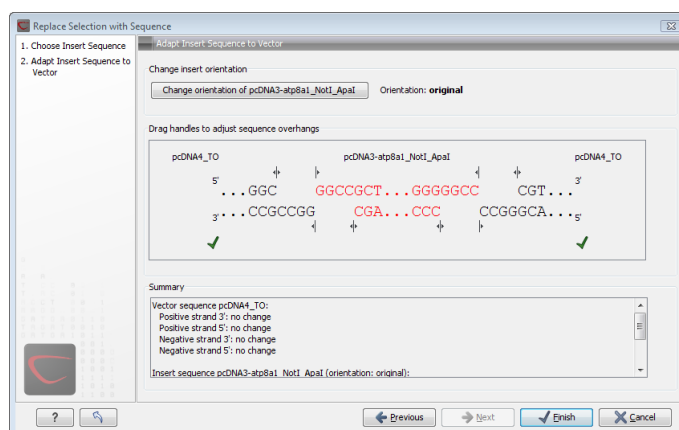





Figure 18.11: Drag the handles to adjust overhangs.

At the top is a button to reverse complement the inserted sequence.

Below is a visualization of the insertion details. The inserted sequence is at the middle shown in red, and the vector has been split at the insertion point and the ends are shown at each side of the inserted sequence.

If the overhangs of the sequence and the vector do not match, you can blunt end or fill in the overhangs using the **drag handles** ().

Whenever you drag the handles, the status of the insertion point is indicated below:

- The overhangs match ().
- The overhangs do not match (). In this case, you will not be able to click **Finish**. Drag the handles to make the overhangs match.

At the bottom of the dialog is a summary field which records all the changes made to the

overhangs. This contents of the summary will also be written in the history (📄) when you click **Finish**.

When you click **Finish** and the sequence is inserted, it will be marked with a selection.

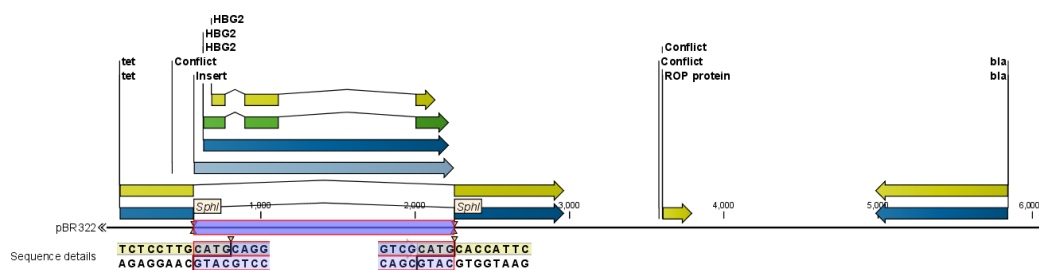

Figure 18.12: One sequence is now inserted into the cloning vector. The sequence inserted is automatically selected.

18.1.4 Insert restriction site

If you make a selection on the sequence, right-click, you find this option for inserting the recognition sequence of a restriction enzyme before or after the region you selected. This will display a dialog as shown in figure 18.13

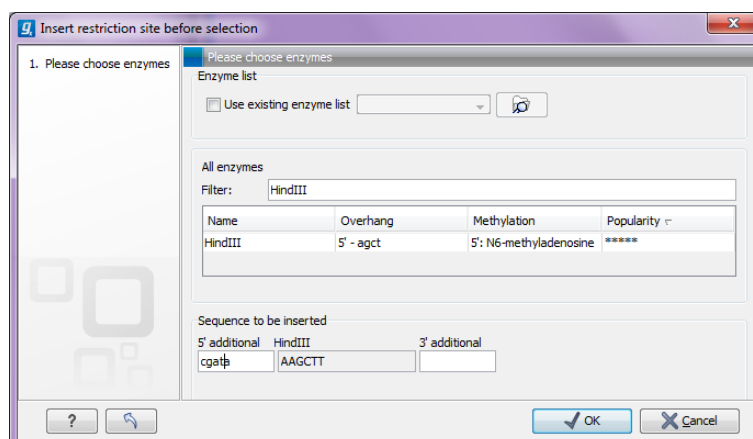

Figure 18.13: Inserting the HindIII recognition sequence.

At the top, you can select an existing enzyme list or you can use the full list of enzymes (default). Select an enzyme, and you will see its recognition sequence in the text field below the list (AAGCTT). If you wish to insert additional residues such as tags etc., this can be typed into the text fields adjacent to the recognition sequence. .

Click **OK** will insert the sequence before or after the selection. If the enzyme selected was not already present in the list in the **Side Panel**, it will now be added and selected. Furthermore, a restriction site annotation is added.

18.2 Gateway cloning

CLC Genomics Workbench offers tools to perform *in silico* Gateway cloning², including Multi-site

²Gateway is a registered trademark of Invitrogen Corporation

Gateway cloning.

The three tools for doing Gateway cloning in the *CLC Genomics Workbench* mimic the procedure followed in the lab:

- First, attB sites are added to a sequence fragment
- Second, the attB-flanked fragment is recombined into a donor vector (the BP reaction) to construct an entry clone
- Finally, the target fragment from the entry clone is recombined into an expression vector (the LR reaction) to construct an expression clone. For Multi-site gateway cloning, multiple entry clones can be created that can recombine in the LR reaction.

During this process, both the attB-flanked fragment and the entry clone can be saved.

For more information about the Gateway technology, please visit <http://www.invitrogen.com/site/us/en/home/Products-and-Services/Applications/Cloning/Gateway-Cloning.html>

To perform these analyses in the *CLC Genomics Workbench*, you need to import donor and expression vectors. These can be downloaded from Invitrogen's web site and directly imported into the Workbench: <http://tools.invitrogen.com/downloads/Gateway%20vectors.ma4>

18.2.1 Add attB sites

The first step in the Gateway cloning process is to amplify the target sequence with primers including so-called attB sites. In the *CLC Genomics Workbench*, you can add attB sites to a sequence fragment in this way:

Toolbox | Molecular Biology Tools (📁) | Cloning and Restriction Sites (📁) | Gateway Cloning (📁) | Add attB Sites (🔗)

This will open a dialog where you can select one or more sequences. Note that if your fragment is part of a longer sequence, you will need to extract it first. This can be done in two ways:

- If the fragment is covered by an annotation (if you want to use e.g. a CDS), simply right-click the annotation and **Open Annotation in New View**
- Otherwise you can simply make a selection on the sequence, right-click and **Open Selection in New View**

In both cases, the selected part of the sequence will be copied and opened as a new sequence which can be **Saved** (📁).

When you have selected your fragment(s), click **Next**.

This will allow you to choose which attB sites you wish to add to each end of the fragment as shown in figure 18.14.

The default option is to use the attB1 and attB2 sites. If you have selected several fragments and wish to add different combinations of sites, you will have to run this tool once for each combination.

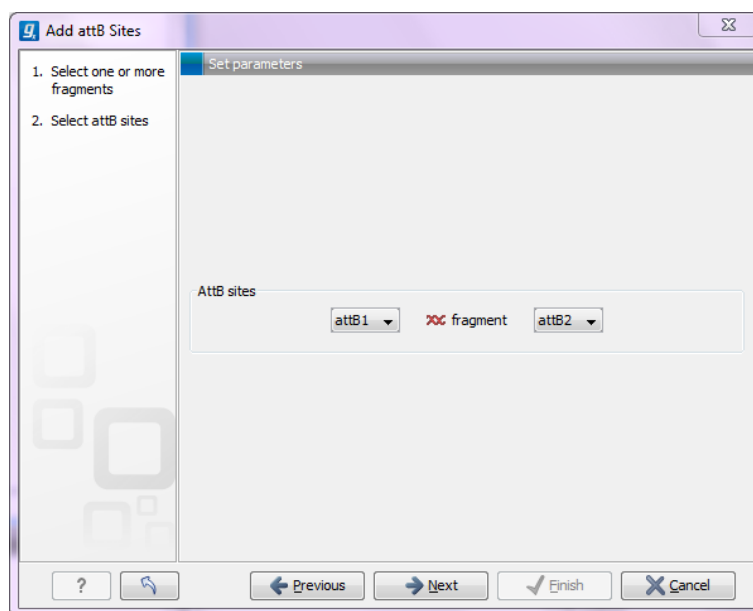

Figure 18.14: Selecting which attB sites to add.

Click **Next** will give you options to extend the fragment with additional sequences by extending the primers 5' of the template-specific part of the primer (i.e. between the template specific part and the attB sites). See an example of this in figure 18.20 where a Shine-Dalgarno site has been added between the attB site and the gene of interest.

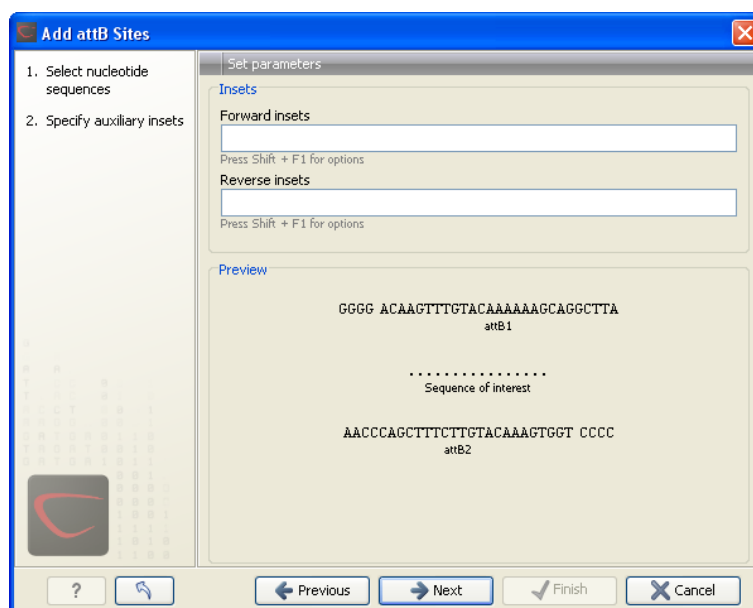

Figure 18.15: Primer additions 5' of the template-specific part of the primer.

At the top of the dialog (see figure 18.15), you can specify primer additions such as a Shine-Dalgarno site, start codon etc. Click in the text field and press **Shift + F1 (Shift + Fn + F1 on Mac)** to show some of the most common additions (see figure 18.16).

Use the up and down arrow keys to select a tag and press **Enter**. This will insert the selected sequence as shown in figure 18.17.

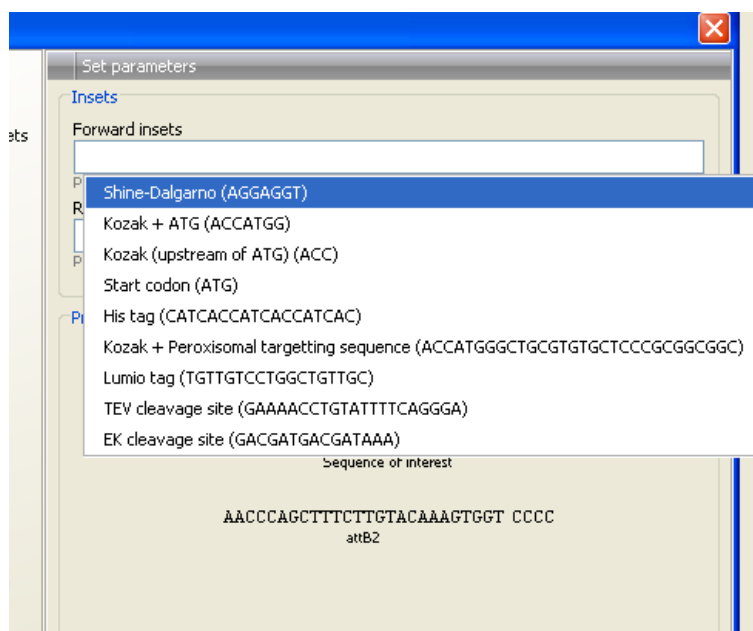

Figure 18.16: Pressing **Shift + F1** shows some of the common additions. This default list can be modified, see section 18.2.1.

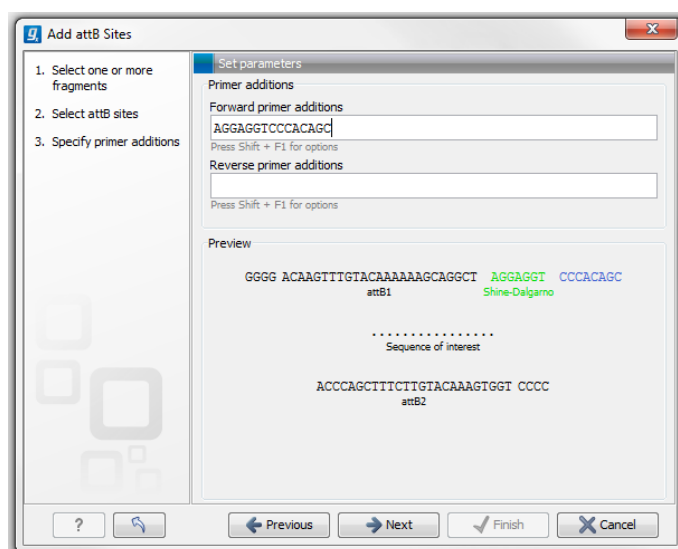

Figure 18.17: A Shine-Dalgarno sequence has been inserted.

At the bottom of the dialog, you can see a preview of what the final PCR product will look like. In the middle there is the sequence of interest (i.e. the sequence you selected as input). In the beginning is the attB1 site, and at the end is the attB2 site. The primer additions that you have inserted are shown in colors (like the green Shine-Dalgarno site in figure 18.17).

This default list of primer additions can be modified, see section 18.2.1.

You can also manually type a sequence with the keyboard or paste in a sequence from the clipboard by pressing **Ctrl + v** (**⌘ + v** on Mac).

Clicking **Next** allows you to specify the length of the template-specific part of the primers as shown in figure 18.18.

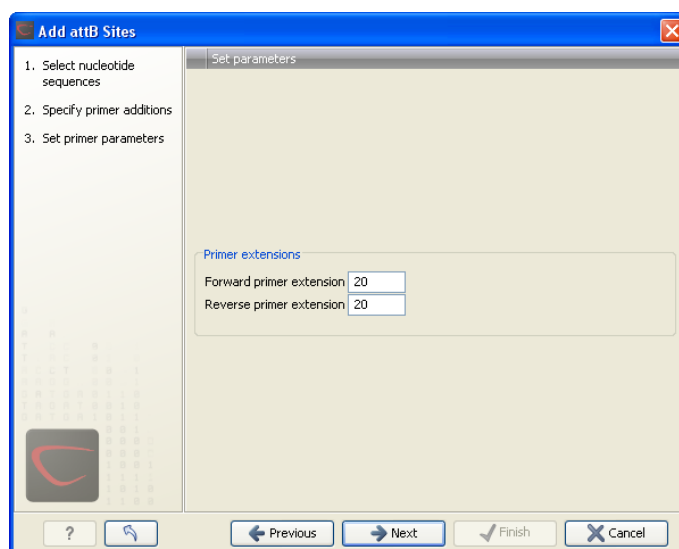

Figure 18.18: Specifying the length of the template-specific part of the primers.

The *CLC Genomics Workbench* is not doing any kind of primer design when adding the attB sites. As a user, you simply specify the length of the template-specific part of the primer, and together with the attB sites and optional primer additions, this will be the primer. The primer region will be annotated in the resulting attB-flanked sequence and you can also get a list of primers as you can see when clicking **Next** (see figure 18.19).

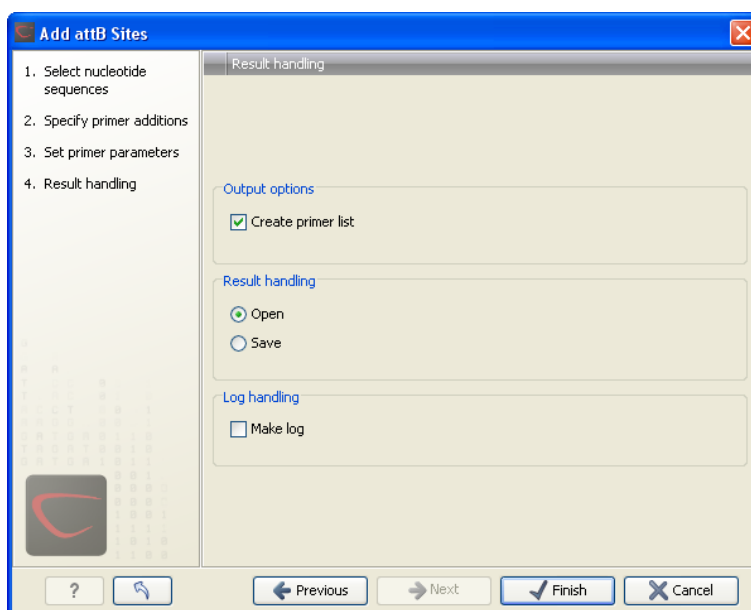

Figure 18.19: Besides the main output which is a copy of the input sequence(s) now including attB sites and primer additions, you can get a list of primers as output.

Besides the main output which is a copy of the input sequence(s) now including attB sites and primer additions, you can get a list of primers as output. Click **Next** if you wish to adjust how to handle the results (see section 8.2). If not, click **Finish**.

The attB sites, the primer additions and the primer regions are annotated in the final result as shown in figure 18.20.

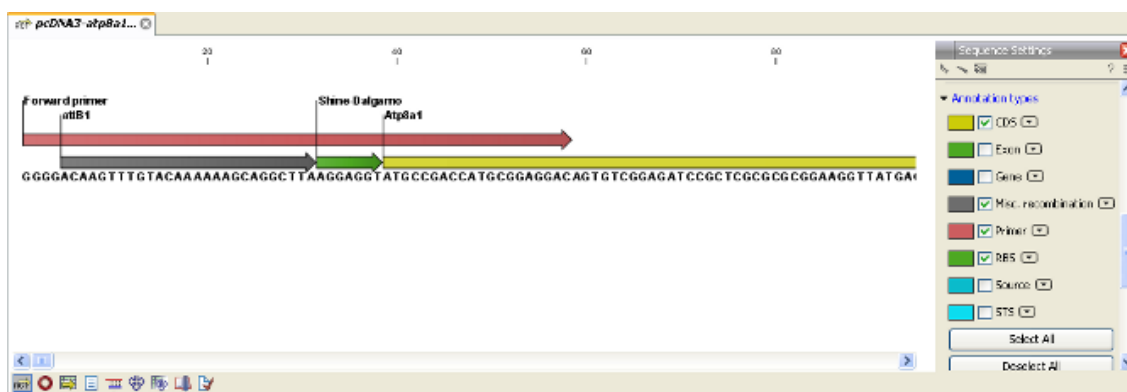

Figure 18.20: the attB site plus the Shine-Dalgarno primer addition is annotated.

There will be one output sequence for each sequence you have selected for adding attB sites. **Save** (↵) the resulting sequence as it will be the input to the next part of the Gateway cloning work flow (see section 18.2.2). When you open the sequence again, you may need to switch on the relevant annotation types to show the sites and primer additions as illustrated in figure 18.20.

Extending the pre-defined list of primer additions

The list of primer additions shown when pressing **Shift+F1** (on Mac: Shift + fn + F1) in the dialog shown in figure 18.15 can be configured and extended. If there is a tag that you use a lot, you can add it to the list for convenient and easy access later on. This is done in the **Preferences**:

Edit | Preferences | Advanced

In the advanced preferences dialog, scroll to the part called **Gateway cloning primer additions** (see figure 18.21).

Each element in the list has the following information:

Name The name of the sequence. When the sequence fragment is extended with a primer addition, an annotation will be added displaying this name.

Sequence The actual sequence to be inserted. The sequence is always defined on the sense strand (although the reverse primer would be reverse complement).

Annotation type The annotation type used for the annotation that is added to the fragment.

Forward primer addition Whether this addition should be visible in the list of additions for the forward primer.

Reverse primer addition Whether this addition should be visible in the list of additions for the reverse primer.

You can either change the existing elements in the table by double-clicking any of the cells, or you can use the buttons below to: **Add Row** or **Delete Row**. If you by accident have deleted or modified some of the default primer additions, you can press **Add Default Rows**. Note that this will not reset the table but only add all the default rows to the existing rows.

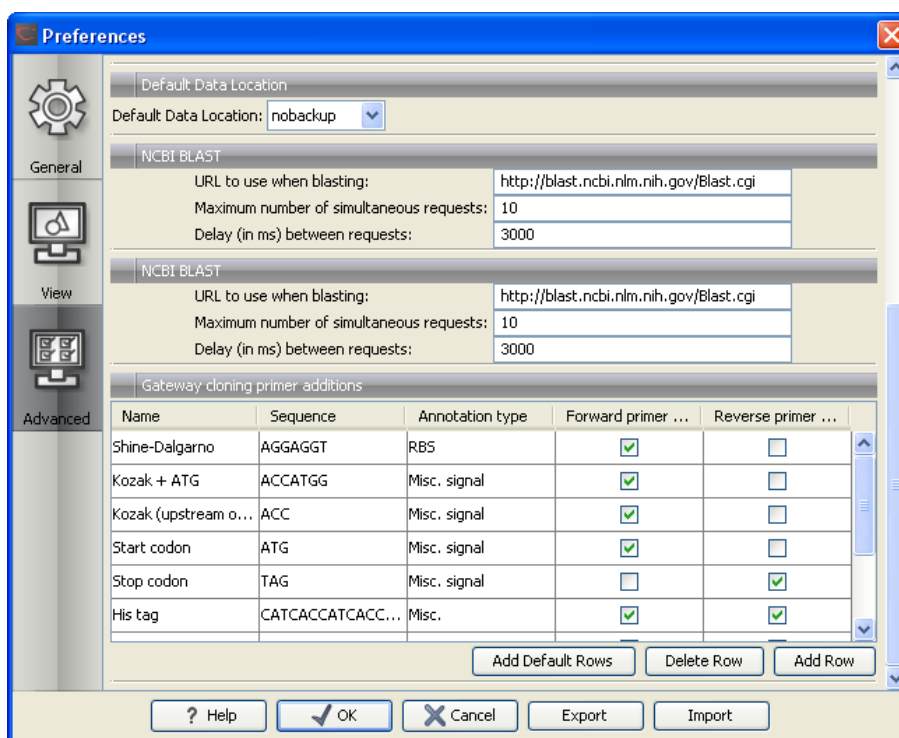

Figure 18.21: Configuring the list of primer additions available when adding attB sites.

18.2.2 Create entry clones (BP)

The next step in the Gateway cloning work flow is to recombine the attB-flanked sequence of interest into a donor vector to create an entry clone, the so-called BP reaction:

Toolbox | Molecular Biology Tools (🔧) | Cloning and Restriction Sites (📁) | Gateway Cloning (📁) | Create Entry Clone (🔄)

This will open a dialog where you can select one or more sequences that will be the sequence of interest to be recombined into your donor vector. Note that the sequences you select should be flanked with attB sites (see section 18.2.1). You can select more than one sequence as input, and the corresponding number of entry clones will be created.

When you have selected your sequence(s), click **Next**.

This will display the dialog shown in figure 18.22.

Clicking the **Browse** (📁) button opens a dialog where you can select a donor vector. You can download donor vectors from Invitrogen's web site: <http://tools.invitrogen.com/downloads/Gateway%20vectors.ma4> and import into the *CLC Genomics Workbench*. Note that the *Workbench* looks for the specific sequences of the attP sites in the sequences that you select in this dialog (see how to change the definition of sites in appendix F). Note that the *CLC Genomics Workbench* only checks that valid attP sites are found - it does not check that they correspond to the attB sites of the selected fragments at this step. If the right combination of attB and attP sites is not found, no entry clones will be produced.

Below there is a preview of the fragments selected and the attB sites that they contain. This can be used to get an overview of which entry clones should be used and check that the right attB sites have been added to the fragments.

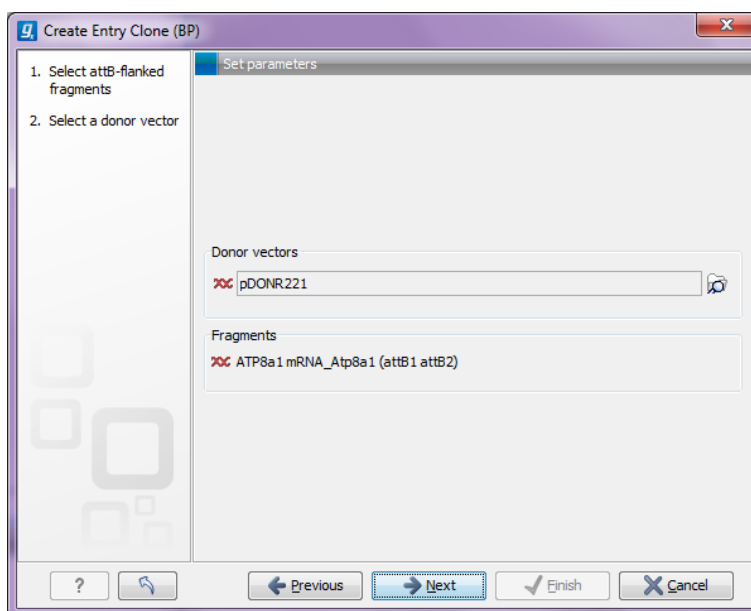

Figure 18.22: Selecting one or more donor vectors.

Click **Next** if you wish to adjust how to handle the results (see section 8.2). If not, click **Finish**.

The output is one entry clone per sequence selected. The attB and attP sites have been used for the recombination, and the entry clone is now equipped with attL sites as shown in figure 18.23.

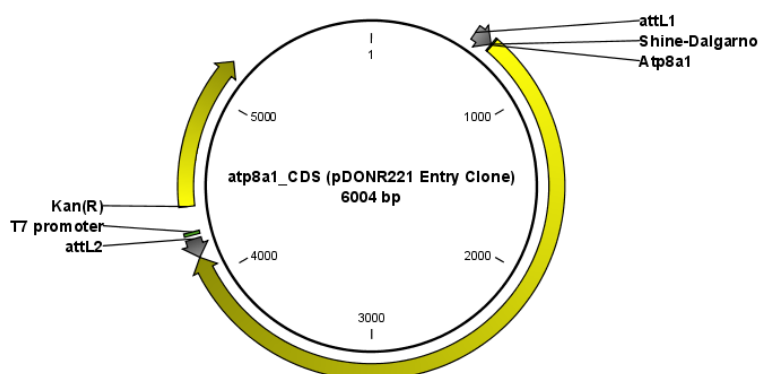

Figure 18.23: The resulting entry vector opened in a circular view.

Note that the bi-product of the recombination is not part of the output.

18.2.3 Create expression clones (LR)

The final step in the Gateway cloning work flow is to recombine the entry clone into a destination vector to create an expression clone, the so-called LR reaction:

Toolbox | Molecular Biology Tools (🔧) | Cloning and Restriction Sites (📄) | Gateway Cloning (📁) | Create Expression Clone (🔄)

This will open a dialog where you can select one or more entry clones (see how to create an entry clone in section 18.2.2). If you wish to perform separate LR reactions with multiple entry clones, you should run the **Create Expression Clone** in batch mode (see section 8.3).

When you have selected your entry clone(s), click **Next**.

This will display the dialog shown in figure 18.24.

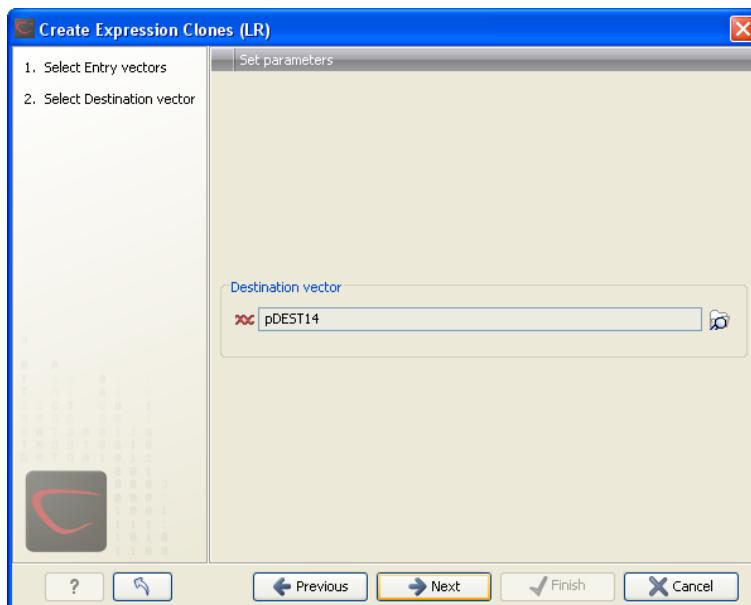



Figure 18.24: Selecting one or more destination vectors.

Clicking the **Browse**  button opens a dialog where you can select a destination vector. You can download donor vectors from Invitrogen's web site: <http://tools.invitrogen.com/downloads/Gateway%20vectors.ma4> and import into the *CLC Genomics Workbench*. Note that the *Workbench* looks for the specific sequences of the attR sites in the sequences that you select in this dialog (see how to change the definition of sites in appendix F). Note that the *CLC Genomics Workbench* only checks that valid attR sites are found - it does not check that they correspond to the attL sites of the selected fragments at this step. If the right combination of attL and attR sites is not found, no entry clones will be produced.

When performing multi-site gateway cloning, the *CLC Genomics Workbench* will insert the fragments (contained in entry clones) by matching the sites that are compatible. If the sites have been defined correctly, an expression clone containing all the fragments will be created. You can find an explanation of the multi-site gateway system at <http://tools.invitrogen.com/downloads/gateway-multisite-seminar.html>

Click **Next** if you wish to adjust how to handle the results (see section 8.2). If not, click **Finish**.

The output is a number of expression clones depending on how many entry clones and destination vectors that you selected. The attL and attR sites have been used for the recombination, and the expression clone is now equipped with attB sites as shown in figure 18.25.

You can choose to create a sequence list with the bi-products as well.

For a destination vector to be recognized, apart from the appropriate att sites, it must contain the *ccdB* gene. This must be present either as a 'ccdB' annotation, or as the exact sequence:

```
ATGCAGTTTAAGGTTTACACCTATAAAAGAGAGAGCCGTTATCGTCTGTTTGTGGATGTACAGAGTGATATT
ATTGACACGCCCGGGCGACGGATGGTGATCCCCCTGGCCAGTGACGCTGCTGTGTCAGATAAAGTCTCC
CGTGAACCTTACCCGGTGGTGCATATCGGGGATGAAAGCTGGCGCATGATGACCACCGATATGGCCAGT
```

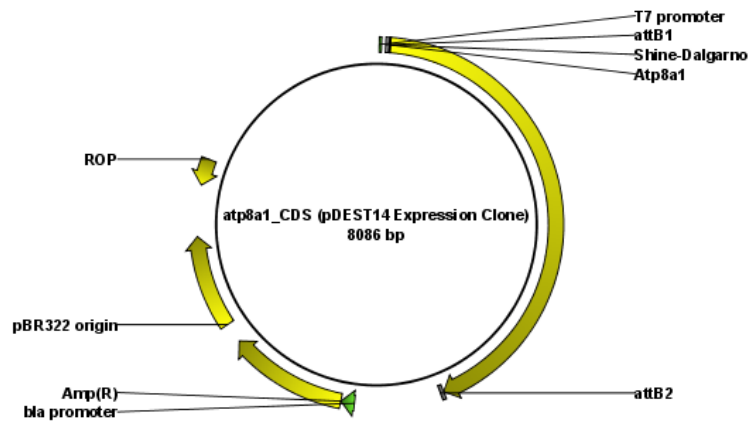

Figure 18.25: The resulting expression clone opened in a circular view.

```
GTGCCGGTCTCCGTTATCGGGGAAGAAGTGGCTGATCTCAGCCACCGCGAAAATGACATCAAAAACGCC
ATTAACCTGATGTTCTGGGGAATATAA
```

If the *ccdB* gene is not present or if the sequence is not identical to the above, a solution is to simply add a 'ccdB' annotation. Select the relevant part of the sequence, right-click and choose 'Add Annotation'. Name the annotation 'ccdB'.

18.3 Restriction site analysis

There are two ways of finding and showing restriction sites:

- In many cases, the dynamic restriction sites found in the **Side Panel** of sequence views will be useful, since it is a quick and easy way of showing restriction sites.
- In the **Toolbox** you will find the other way of doing restriction site analyses. This way provides more control of the analysis and gives you more output options, e.g. a table of restriction sites and you can perform the same restriction map analysis on several sequences in one step.

This chapter first describes the dynamic restriction sites, followed by a description of how to do restriction site analyses via the toolbox (you can run more extensive analysis via the restriction analysis tools available in the toolbox). This section also includes an explanation of how to simulate a gel with the selected enzymes. The final section in this chapter focuses on enzyme lists which represent an easy way of managing restriction enzymes.

18.3.1 Dynamic restriction sites

If you open a sequence, a sequence list etc, you will find the **Restriction Sites** group in the **Side Panel**.

As shown in figure 18.26 you can display restriction sites as colored triangles and lines on the sequence. The **Restriction sites** group in the side panel shows a list of enzymes, represented by different colors corresponding to the colors of the triangles on the sequence. By selecting or deselecting the enzymes in the list, you can specify which enzymes' restriction sites should be displayed.



Figure 18.26: Showing restriction sites of ten restriction enzymes.

The color of the restriction enzyme can be changed by clicking the colored box next to the enzyme's name. The name of the enzyme can also be shown next to the restriction site by selecting **Show name flags** above the list of restriction enzymes.

There is also an option to specify how the **Labels** shown be shown:

- **No labels.** This will just display the cut site with no information about the name of the enzyme. Placing the mouse button on the cut site will reveal this information as a tool tip.
- **Flag.** This will place a flag just above the sequence with the enzyme name (see an example in figure 18.27). Note that this option will make it hard to see when several cut sites are located close to each other. In the circular view, this option is replaced by the Radial option:
- **Radial.** This option is only available in the circular view. It will place the restriction site labels as close to the cut site as possible (see an example in figure 18.29).
- **Stacked.** This is similar to the flag option for linear sequence views, but it will stack the labels so that all enzymes are shown. For circular views, it will align all the labels on each side of the circle. This can be useful for clearly seeing the order of the cut sites when they are located closely together (see an example in figure 18.28).



Figure 18.27: Restriction site labels shown as flags.

Note that in a circular view, the **Stacked** and **Radial** options also affect the layout of annotations.

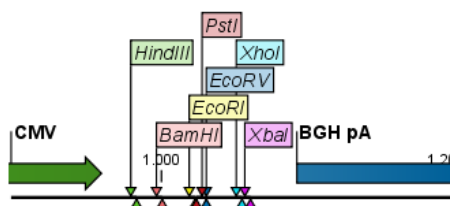

Figure 18.28: Restriction site labels stacked.

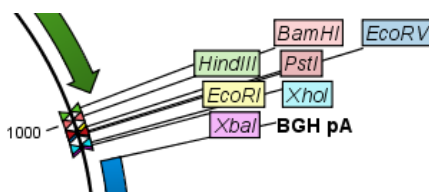

Figure 18.29: Restriction site labels in radial layout.

Sort enzymes

Just above the list of enzymes there are three buttons to be used for sorting the list (see figure 18.30):

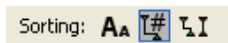

Figure 18.30: Buttons to sort restriction enzymes.

- **Sort enzymes alphabetically (AA).** Clicking this button will sort the list of enzymes alphabetically.
- **Sort enzymes by number of restriction sites (T#).** This will divide the enzymes into four groups:
 - Non-cutters.
 - Single cutters.
 - Double cutters.
 - Multiple cutters.

There is a checkbox for each group which can be used to hide / show all the enzymes in a group.

- **Sort enzymes by overhang (LI).** This will divide the enzymes into three groups:
 - Blunt. Enzymes cutting both strands at the same position.
 - 3'. Enzymes producing an overhang at the 3' end.
 - 5'. Enzymes producing an overhang at the 5' end.

There is a checkbox for each group which can be used to hide / show all the enzymes in a group.

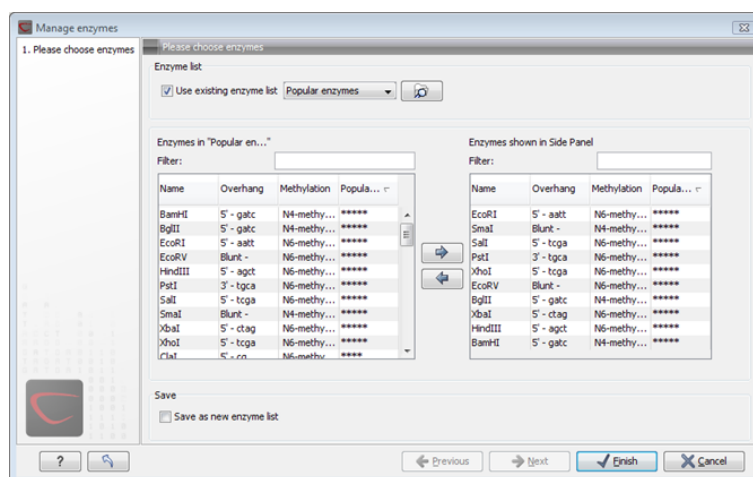

Figure 18.31: Adding or removing enzymes from the Side Panel.

Manage enzymes

The list of restriction enzymes contains per default 20 of the most popular enzymes, but you can easily modify this list and add more enzymes by clicking the **Manage enzymes button**. This will display the dialog shown in figure 18.31.

At the top, you can choose to **Use existing enzyme list**. Clicking this option lets you select an enzyme list which is stored in the **Navigation Area**. A list of popular enzymes is available in the Example Data folder you can download from the Help menu.

Below there are two panels:

- To the **left**, you can see all the enzymes that are in the list selected above. If you have not chosen to use an existing enzyme list, this panel shows all the enzymes available.
- To the **right**, you can see the list of the enzymes that will be used.

Select enzymes in the left side panel and add them to the right panel by double-clicking or clicking the **Add** button (➡). If you e.g. wish to use EcoRV and BamHI, select these two enzymes and add them to the right side panel.

If you wish to use all the enzymes in the list:

Click in the panel to the left | press Ctrl + A (⌘ + A on Mac) | Add (➡)

The enzymes can be sorted by clicking the column headings, i.e. Name, Overhang, Methylation or Popularity. This is particularly useful if you wish to use enzymes which produce a 3' overhang. In this case, you can sort the list by clicking the Overhang column heading, and all the enzymes producing 3' overhangs will be listed together for easy selection.

When looking for a specific enzyme, it is easier to use the Filter. If you wish to find e.g. HindIII sites, simply type HindIII into the filter, and the list of enzymes will shrink automatically to only include the HindIII enzyme. This can also be used to only show enzymes producing a blunt cut site as shown in figure 18.50.

If you need more detailed information and filtering of the enzymes, either place your mouse cursor on an enzyme for one second to display additional information (see figure 18.51), or use the view of enzyme lists (see 18.5).

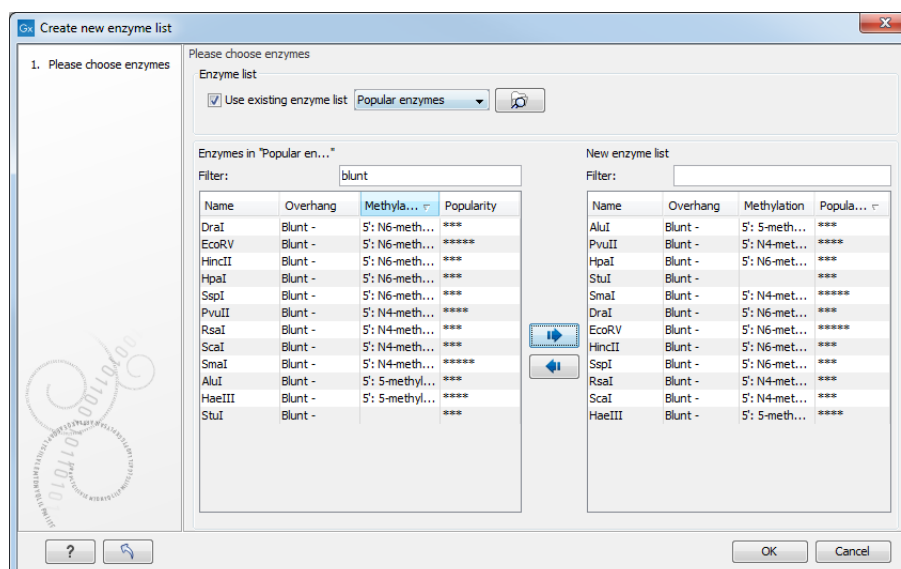

Figure 18.32: Selecting enzymes.

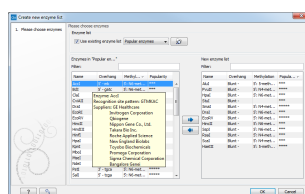

Figure 18.33: Showing additional information about an enzyme like recognition sequence or a list of commercial vendors.

At the bottom of the dialog, you can select to save this list of enzymes as a new file. In this way, you can save the selection of enzymes for later use.

When you click **Finish**, the enzymes are added to the Side Panel and the cut sites are shown on the sequence.

If you have specified a set of enzymes which you always use, it will probably be a good idea to save the settings in the Side Panel (see section 4.6) for future use.

Show enzymes cutting inside/outside selection

Section 18.3.1 describes how to add more enzymes to the list in the Side Panel based on the name of the enzyme, overhang, methylation sensitivity etc. However, you will often find yourself in a situation where you need a more sophisticated and explorative approach.

An illustrative example: you have a selection on a sequence, and you wish to find enzymes cutting within the selection, but not outside. This problem often arises during design of cloning experiments. In this case, you do not know the name of the enzyme, so you want the Workbench to find the enzymes for you:

right-click the selection | Show Enzymes Cutting Inside/Outside Selection (🔍)

This will display the dialog shown in figure 18.34 where you can specify which enzymes should initially be considered.

At the top, you can choose to **Use existing enzyme list**. Clicking this option lets you select an

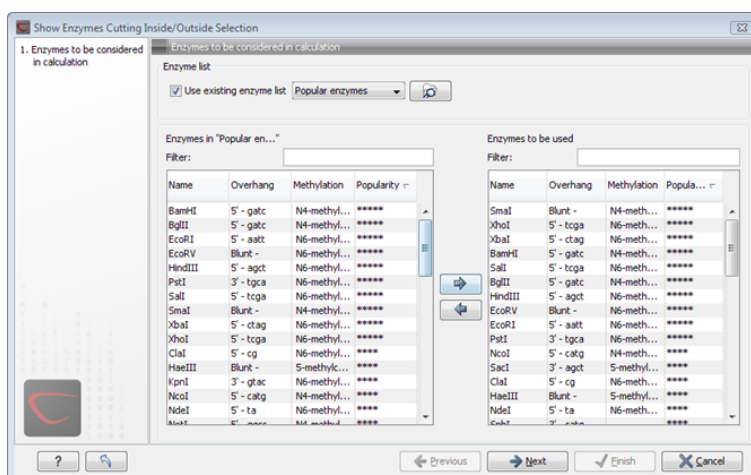

Figure 18.34: Choosing enzymes to be considered.

enzyme list which is stored in the **Navigation Area**. A list of popular enzymes is available in the Example Data folder you can download from the Help menu.

Below there are two panels:

- To the **left**, you can see all the enzymes that are in the list selected above. If you have not chosen to use an existing enzyme list, this panel shows all the enzymes available.
- To the **right**, you can see the list of the enzymes that will be used.

Select enzymes in the left side panel and add them to the right panel by double-clicking or clicking the **Add** button (➡). If you e.g. wish to use EcoRV and BamHI, select these two enzymes and add them to the right side panel.

If you wish to use all the enzymes in the list:

Click in the panel to the left | press Ctrl + A (⌘ + A on Mac) | Add (➡)

The enzymes can be sorted by clicking the column headings, i.e. Name, Overhang, Methylation or Popularity. This is particularly useful if you wish to use enzymes which produce a 3' overhang. In this case, you can sort the list by clicking the Overhang column heading, and all the enzymes producing 3' overhangs will be listed together for easy selection.

When looking for a specific enzyme, it is easier to use the Filter. If you wish to find e.g. HindIII sites, simply type HindIII into the filter, and the list of enzymes will shrink automatically to only include the HindIII enzyme. This can also be used to only show enzymes producing a blunt cut site as shown in figure 18.50.

If you need more detailed information and filtering of the enzymes, either place your mouse cursor on an enzyme for one second to display additional information (see figure 18.51), or use the view of enzyme lists (see 18.5).

Clicking **Next** will show the dialog in figure 18.37.

At the top of the dialog, you see the selected region, and below are two panels:

- **Inside selection.** Specify how many times you wish the enzyme to cut inside the selection.

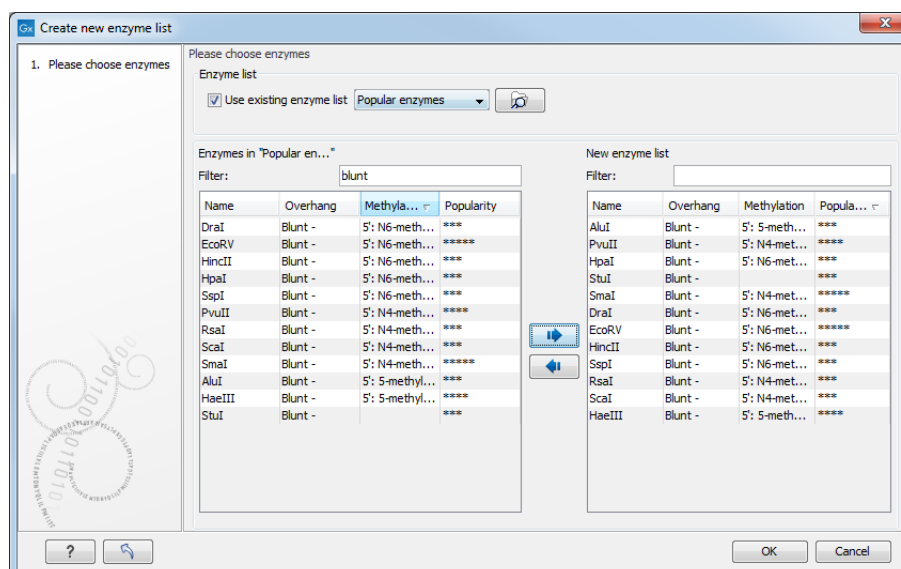

Figure 18.35: Selecting enzymes.

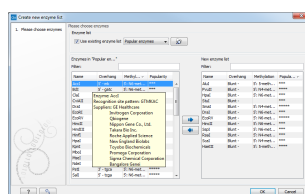

Figure 18.36: Showing additional information about an enzyme like recognition sequence or a list of commercial vendors.

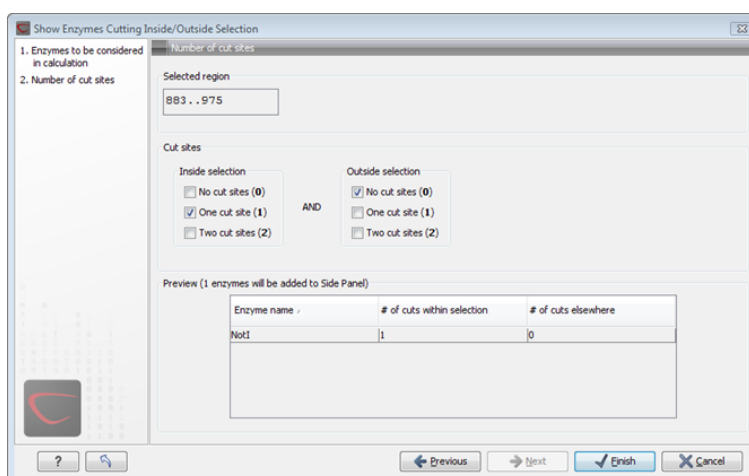

Figure 18.37: Deciding number of cut sites inside and outside the selection.

In the example described above, "One cut site (1)" should be selected to only show enzymes cutting once in the selection.

- **Outside selection.** Specify how many times you wish the enzyme to cut outside the selection (i.e. the rest of the sequence). In the example above, "No cut sites (0)" should be selected.

These panels offer a lot of flexibility for combining number of cut sites inside and outside the selection, respectively. To give a hint of how many enzymes will be added based on the

combination of cut sites, the preview panel at the bottom lists the enzymes which will be added when you click **Finish**. Note that this list is dynamically updated when you change the number of cut sites. The enzymes shown in brackets [] are enzymes which are already present in the Side Panel.

If you have selected more than one region on the sequence (using Ctrl or ⌘), they will be treated as individual regions. This means that the criteria for cut sites apply to each region.

Show enzymes with compatible ends

Besides what is described above, there is a third way of adding enzymes to the Side Panel and thereby displaying them on the sequence. It is based on the overhang produced by cutting with an enzyme and will find enzymes producing a compatible overhang:

right-click the restriction site | Show Enzymes with Compatible Ends (⌘ I)

This will display the dialog shown in figure 18.38.

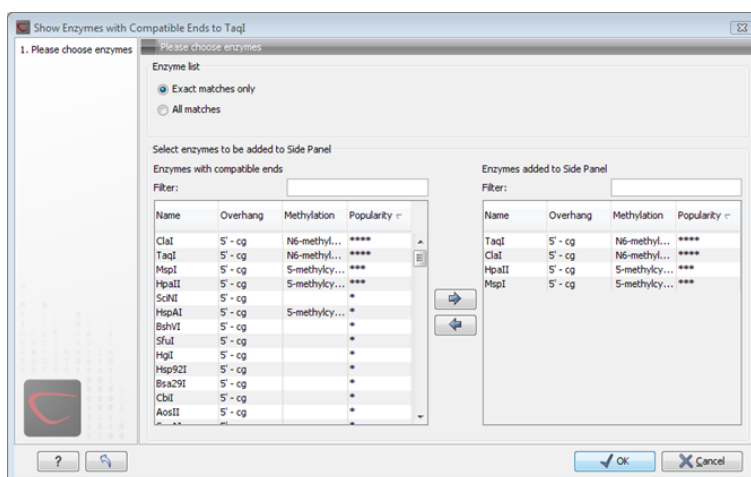

Figure 18.38: Enzymes with compatible ends.

At the top you can choose whether the enzymes considered should have an exact match or not. Since a number of restriction enzymes have ambiguous cut patterns, there will be variations in the resulting overhangs. Choosing **All matches**, you cannot be 100% sure that the overhang will match, and you will need to inspect the sequence further afterwards.

We advice trying **Exact match** first, and use **All matches** as an alternative... if a satisfactory result cannot be achieved.

At the bottom of the dialog, the list of enzymes producing compatible overhangs is shown. Use the arrows to add enzymes which will be displayed on the sequence which you press **Finish**.

When you have added the relevant enzymes, click **Finish**, and the enzymes will be added to the Side Panel and their cut sites displayed on the sequence.

18.3.2 Restriction site analysis from the Toolbox

Besides the dynamic restriction sites, you can do a more elaborate restriction map analysis with more output format using the Toolbox:

Toolbox | Molecular Biology Tools (🔧) | Cloning and Restriction Sites (📄) | Restriction Site Analysis (✂️)

This will display the dialog shown in figure 18.39.

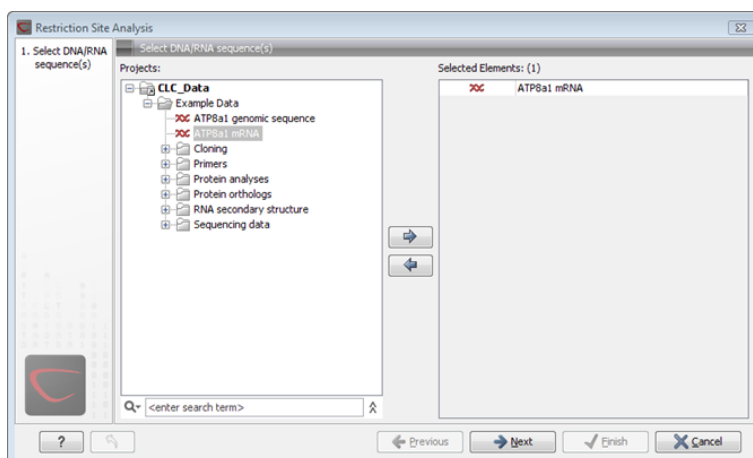

Figure 18.39: Choosing sequence *ATP8a1 mRNA* for restriction map analysis.

If a sequence was selected before choosing the Toolbox action, this sequence is now listed in the **Selected Elements** window of the dialog. Use the arrows to add or remove sequences or sequence lists from the selected elements.

Selecting, sorting and filtering enzymes

Clicking **Next** lets you define which enzymes to use as basis for finding restriction sites on the sequence. At the top, you can choose to **Use existing enzyme list**. Clicking this option lets you select an enzyme list which is stored in the **Navigation Area**. A list of popular enzymes is available in the Example Data folder you can download from the Help menu.

Below there are two panels:

- To the **left**, you can see all the enzymes that are in the list selected above. If you have not chosen to use an existing enzyme list, this panel shows all the enzymes available.
- To the **right**, you can see the list of the enzymes that will be used.

Select enzymes in the left side panel and add them to the right panel by double-clicking or clicking the **Add** button (➡). If you e.g. wish to use EcoRV and BamHI, select these two enzymes and add them to the right side panel.

If you wish to use all the enzymes in the list:

Click in the panel to the left | press Ctrl + A (⌘ + A on Mac) | Add (➡)

The enzymes can be sorted by clicking the column headings, i.e. Name, Overhang, Methylation or Popularity. This is particularly useful if you wish to use enzymes which produce a 3' overhang. In this case, you can sort the list by clicking the Overhang column heading, and all the enzymes producing 3' overhangs will be listed together for easy selection.

When looking for a specific enzyme, it is easier to use the Filter. If you wish to find e.g. HindIII sites, simply type HindIII into the filter, and the list of enzymes will shrink automatically to only

include the HindIII enzyme. This can also be used to only show enzymes producing a blunt cut site as shown in figure 18.50.

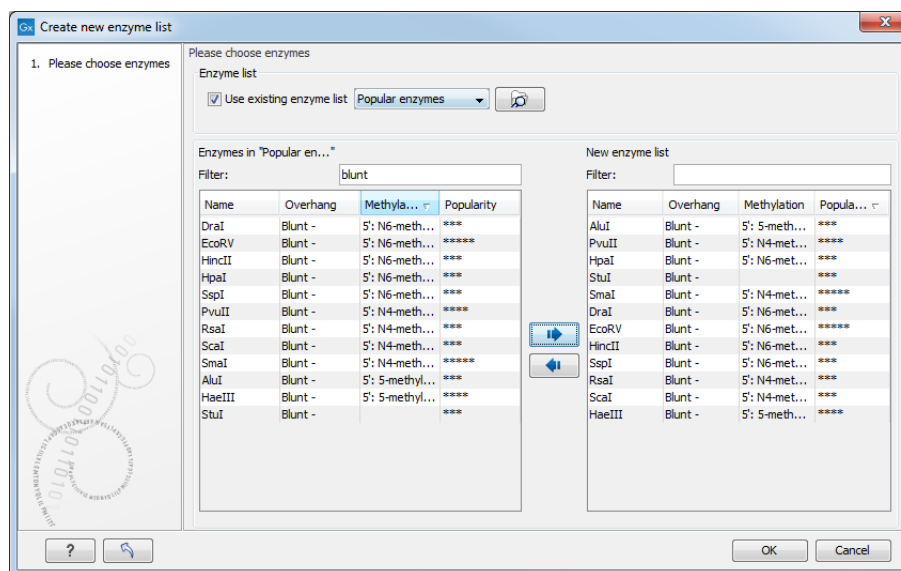

Figure 18.40: Selecting enzymes.

If you need more detailed information and filtering of the enzymes, either place your mouse cursor on an enzyme for one second to display additional information (see figure 18.51), or use the view of enzyme lists (see 18.5).

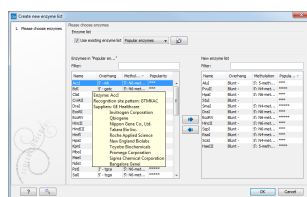

Figure 18.41: Showing additional information about an enzyme like recognition sequence or a list of commercial vendors.

Number of cut sites

Clicking **Next** confirms the list of enzymes which will be included in the analysis, and takes you to the dialog shown in figure 18.42.

If you wish the output of the restriction map analysis only to include restriction enzymes which cut the sequence a specific number of times, use the checkboxes in this dialog:

- No restriction site (**0**)
- One restriction site (**1**)
- Two restriction sites (**2**)
- Three restriction site (**3**)
- N restriction sites

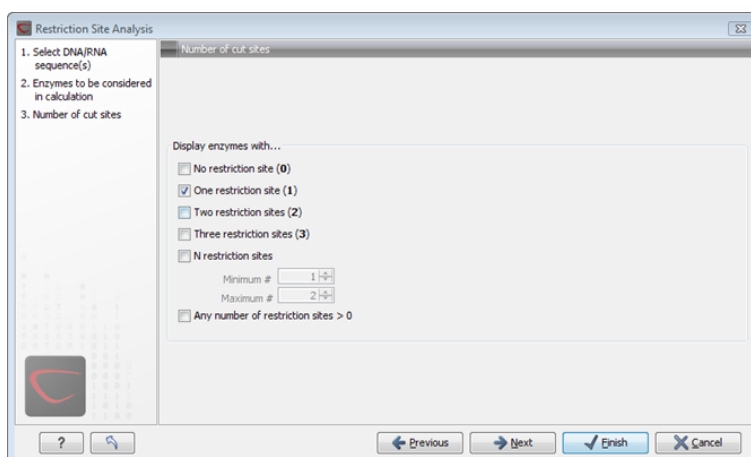

Figure 18.42: Selecting number of cut sites.

- Minimum
- Maximum
- Any number of restriction sites > 0

The default setting is to include the enzymes which cut the sequence one or two times.

You can use the checkboxes to perform very specific searches for restriction sites: e.g. if you wish to find enzymes which do not cut the sequence, or enzymes cutting exactly twice.

Output of restriction map analysis

Clicking next shows the dialog in figure 18.43.

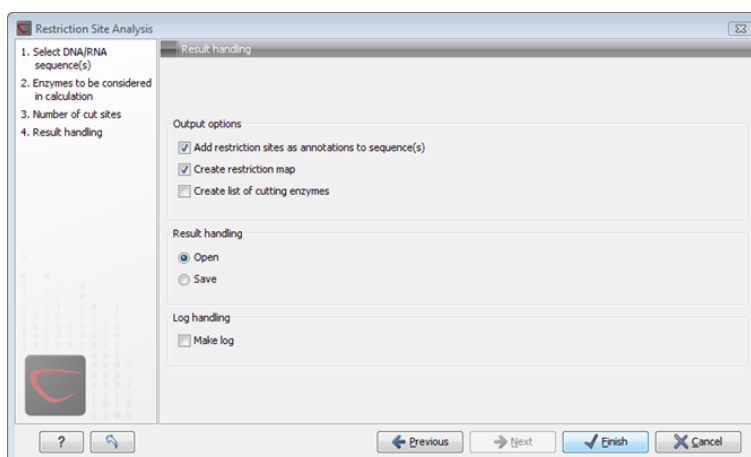

Figure 18.43: Choosing to add restriction sites as annotations or creating a restriction map.

This dialog lets you specify how the result of the restriction map analysis should be presented:

- **Add restriction sites as annotations to sequence(s).** This option makes it possible to see the restriction sites on the sequence (see figure 18.44) and save the annotations for later use.

- **Create restriction map.** The restriction map is a table of restriction sites as shown in figure 18.45. If more than one sequence were selected, the table will include the restriction sites of all the sequences. This makes it easy to compare the result of the restriction map analysis for two sequences (or more).
 - **Add restriction sites as annotations to sequence(s).** This option makes it possible to see the restriction sites on the sequence (see figure 18.44) and save the annotations for later use.
 - **Create restriction map.** When a restriction map is created, it can be shown in three different ways:
 - As a **table of restriction sites** as shown in figure 18.45. If more than one sequence were selected, the table will include the restriction sites of all the sequences. This makes it easy to compare the result of the restriction map analysis for two sequences.
 - As a **table of fragments** which shows the sequence fragments that would be the result of cutting the sequence with the selected enzymes (see figure 18.46).
 - As a **virtual gel** simulation which shows the fragments as bands on a gel (see figure 18.48).
- For more information about gel electrophoresis, see section 18.4.

The following sections will describe these output formats in more detail.

In order to complete the analysis click **Finish** (see section 8.2 for information about the Save and Open options).

Restriction sites as annotation on the sequence

If you chose to add the restriction sites as annotation to the sequence, the result will be similar to the sequence shown in figure 18.44. See section 10.3 for more information about viewing



Figure 18.44: *The result of the restriction analysis shown as annotations.*

annotations.

Table of restriction sites

The restriction map can be shown as a table of restriction sites (see figure 18.45).

Each row in the table represents a restriction enzyme. The following information is available for each enzyme:

- **Sequence.** The name of the sequence which is relevant if you have performed restriction map analysis on more than one sequence.
- **Name.** The name of the enzyme.

Sequ...	Name	Pattern	Overhang	Number ...	Cut position(s)
PERH3BC	CjePI	ccannnnnntc	3'	1	(151, 184)
PERH3BC	MboII	gaaga	3'	1	86
PERH3BC	NcuI	gaaga	3'	1	86
PERH3BC	TsoI	tarcca	3'	1	[134]
PERH3BC	Tth111II	caarca	3'	1	[101]

Figure 18.45: The result of the restriction analysis shown as annotations.

- **Pattern.** The recognition sequence of the enzyme.
- **Overhang.** The overhang produced by cutting with the enzyme (3', 5' or Blunt).
- **Number of cut sites.**
- **Cut position(s).** The position of each cut.
 - , If the enzyme cuts more than once, the positions are separated by commas.
 - [] If the enzyme's recognition sequence is on the negative strand, the cut position is put in brackets (as the enzyme TsoI in figure 18.45 whose cut position is [134]).
 - () Some enzymes cut the sequence twice for each recognition site, and in this case the two cut positions are surrounded by parentheses.

Table of restriction fragments

The restriction map can be shown as a table of fragments produced by cutting the sequence with the enzymes:

Click the Fragments button (📄) at the bottom of the view

The table is shown in see figure 18.46.

Each row in the table represents a fragment. If more than one enzyme cuts in the same region, or if an enzyme's recognition site is cut by another enzyme, there will be a fragment for each of the possible cut combinations³. The following information is available for each fragment.

- **Sequence.** The name of the sequence which is relevant if you have performed restriction map analysis on more than one sequence.
- **Length.** The length of the fragment. If there are overhangs of the fragment, these are included in the length (both 3' and 5' overhangs).
- **Region.** The fragment's region on the original sequence.
- **Overhangs.** If there is an overhang, this is displayed with an abbreviated version of the fragment and its overhangs. The two rows of dots (.) represent the two strands of the fragment and the overhang is visualized on each side of the dots with the residue(s) that make up the overhang. If there are only the two rows of dots, it means that there is no overhang.

³Furthermore, if this is the case, you will see the names of the other enzymes in the **Conflicting Enzymes** column

Sequence	Length	Region	Overhangs	Left end	Right end	Conflicting enzymes
PERH3BC	35	100..134TG AC.....	Tth111III	TsoI	TsoI, CjePI
PERH3BC	52	100..151GTTATT AC.....	Tth111III	CjePI	TsoI, CjePI
PERH3BC	19	133..151GTTATT AC.....	TsoI	CjePI	TsoI, CjePI
PERH3BC	39	146..184CTCTCA CAATAA.....	CjePI	CjePI	
PERH3BC	18	179..196 GAGACT.....	CjePI		

Figure 18.46: The result of the restriction analysis shown as annotations.

- **Left end.** The enzyme that cuts the fragment to the left (5' end).
- **Right end.** The enzyme that cuts the fragment to the right (3' end).
- **Conflicting enzymes.** If more than one enzyme cuts at the same position, or if an enzyme's recognition site is cut by another enzyme, a fragment is displayed for each possible combination of cuts. At the same time, this column will display the enzymes that are in conflict. If there are conflicting enzymes, they will be colored red to alert the user. If the same experiment were performed in the lab, conflicting enzymes could lead to wrong results. For this reason, this functionality is useful to simulate digestions with complex combinations of restriction enzymes.

If views of both the fragment table and the sequence are open, clicking in the fragment table will select the corresponding region on the sequence.

Gel

The restriction map can also be shown as a gel. This is described in section [18.4.1](#).

18.4 Gel electrophoresis

CLC Genomics Workbench enables the user to simulate the separation of nucleotide sequences on a gel. This feature is useful when e.g. designing an experiment which will allow the differentiation of a successful and an unsuccessful cloning experiment on the basis of a restriction map.

There are two main ways to simulate gel separation of nucleotide sequences:

- One or more sequences can be digested with restriction enzymes and the resulting fragments can be separated on a gel.

- A number of existing sequences can be separated on a gel.

There are several ways to apply these functionalities as described below.

18.4.1 Separate fragments of sequences on gel

This section explains how to simulate a gel electrophoresis of one or more sequences which are digested with restriction enzymes. There are two ways to do this:

- When performing the **Restriction Site Analysis** from the **Toolbox**, you can choose to create a restriction map which can be shown as a gel.

This is explained in section [18.3.2](#).

- From all the graphical views of sequences, you can right-click the name of the sequence and choose: **Digest Sequence with Selected Enzymes and Run on Gel** (). The views where this option is available are listed below:
 - Circular view (see section [10.2](#)).
 - Ordinary sequence view (see section [10.1](#)).
 - Graphical view of sequence lists (see section [10.6](#)).
 - Cloning editor (see section [18.1](#)).
 - Primer designer (see section [16.3](#)).

Furthermore, you can also right-click an empty part of the view of the graphical view of sequence lists and the cloning editor and choose **Digest All Sequences with Selected Enzymes and Run on Gel**.

Note! When using the right-click options, the sequence will be digested with the enzymes that are selected in the **Side Panel**. This is explained in section [10.1.1](#).

The view of the gel is explained in section [18.4.3](#)

18.4.2 Separate sequences on gel

To separate sequences without restriction enzyme digestion, first create a sequence list of the sequences in question (see section [10.6](#)). Then click the **Gel** button () at the bottom of the view of the sequence list.

For more information about the view of the gel, see the next section.

18.4.3 Gel view

In figure [18.48](#) you can see a simulation of a gel with its **Side Panel** to the right. This view will be explained in this section.

Information on bands / fragments

You can get information about the individual bands by hovering the mouse cursor on the band of interest. This will display a tool tip with the following information:

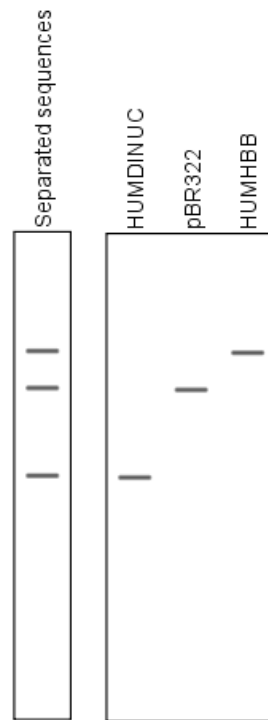

Figure 18.47: A sequence list shown as a gel.

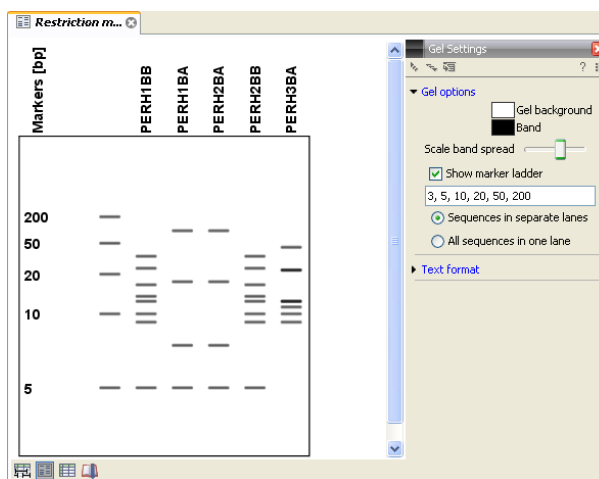

Figure 18.48: Five lanes showing fragments of five sequences cut with restriction enzymes.

- Fragment length
- Fragment region on the original sequence
- Enzymes cutting at the left and right ends, respectively

For gels comparing whole sequences, you will see the sequence name and the length of the sequence.

Note! You have to be in **Selection** () or **Pan** () mode in order to get this information.

It can be useful to add markers to the gel which enables you to compare the sizes of the bands. This is done by clicking **Show marker ladder** in the **Side Panel**.



Markers can be entered into the text field, separated by commas.

Modifying the layout

The background of the lane and the colors of the bands can be changed in the **Side Panel**. Click the colored box to display a dialog for picking a color. The slider **Scale band spread** can be used to adjust the effective time of separation on the gel, i.e. how much the bands will be spread over the lane. In a real electrophoresis experiment this property will be determined by several factors including time of separation, voltage and gel density.

You can also choose how many lanes should be displayed:

- **Sequences in separate lanes.** This simulates that a gel is run for each sequence.
- **All sequences in one lane.** This simulates that one gel is run for all sequences.

You can also modify the layout of the view by zooming in or out. Click **Zoom in** () or **Zoom out** () in the Toolbar and click the view.

Finally, you can modify the format of the text heading each lane in the **Text format** preferences in the **Side Panel**.

18.5 Restriction enzyme lists

CLC Genomics Workbench includes all the restriction enzymes available in the **REBASE** database, with methylation shown as performed by the cognate methylase rather than by Dam/Dcm. If you want to customize the enzyme database for your installation, see section E. However, when performing restriction site analyses, it is often an advantage to use a customized list of enzymes. In this case, the user can create special lists containing for example all enzymes available in the laboratory freezer, or all enzymes used to create a given restriction map or all enzymes that are available from the preferred vendor.

In the example data (see section 1.5.2) under Nucleotide->Restriction analysis, there are two enzyme lists: one with the 50 most popular enzymes, and another with all enzymes that are included in the *CLC Genomics Workbench*.

This section describes how you can create an enzyme list, and how you can modify it.

18.5.1 Create enzyme list

CLC Genomics Workbench uses enzymes from the **REBASE** restriction enzyme database at <http://rebase.neb.com>. If you want to customize the enzyme database for your installation, see section E.

To create an enzyme list of a subset of these enzymes:

File | New | Enzyme list ()

This opens the dialog shown in figure 18.49

At the top, you can choose to **Use existing enzyme list**. Clicking this option lets you select an enzyme list which is stored in the **Navigation Area**. A list of popular enzymes is available in the

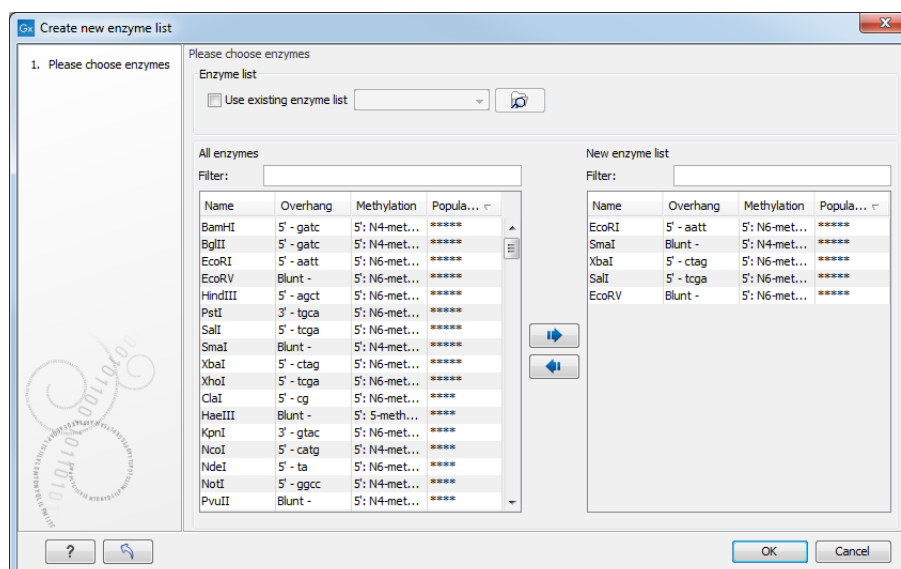

Figure 18.49: Choosing enzymes for the new enzyme list.

Example Data folder you can download from the Help menu.

Below there are two panels:

- To the **left**, you can see all the enzymes that are in the list selected above. If you have not chosen to use an existing enzyme list, this panel shows all the enzymes available.
- To the **right**, you can see the list of the enzymes that will be used.

Select enzymes in the left side panel and add them to the right panel by double-clicking or clicking the **Add** button (➡). If you e.g. wish to use EcoRV and BamHI, select these two enzymes and add them to the right side panel.

If you wish to use all the enzymes in the list:

Click in the panel to the left | press Ctrl + A (⌘ + A on Mac) | Add (➡)

The enzymes can be sorted by clicking the column headings, i.e. Name, Overhang, Methylation or Popularity. This is particularly useful if you wish to use enzymes which produce a 3' overhang. In this case, you can sort the list by clicking the Overhang column heading, and all the enzymes producing 3' overhangs will be listed together for easy selection.

When looking for a specific enzyme, it is easier to use the Filter. If you wish to find e.g. HindIII sites, simply type HindIII into the filter, and the list of enzymes will shrink automatically to only include the HindIII enzyme. This can also be used to only show enzymes producing a blunt cut site as shown in figure 18.50.

If you need more detailed information and filtering of the enzymes, either place your mouse cursor on an enzyme for one second to display additional information (see figure 18.51), or use the view of enzyme lists (see 18.5).

Click **Finish** to open the enzyme list.

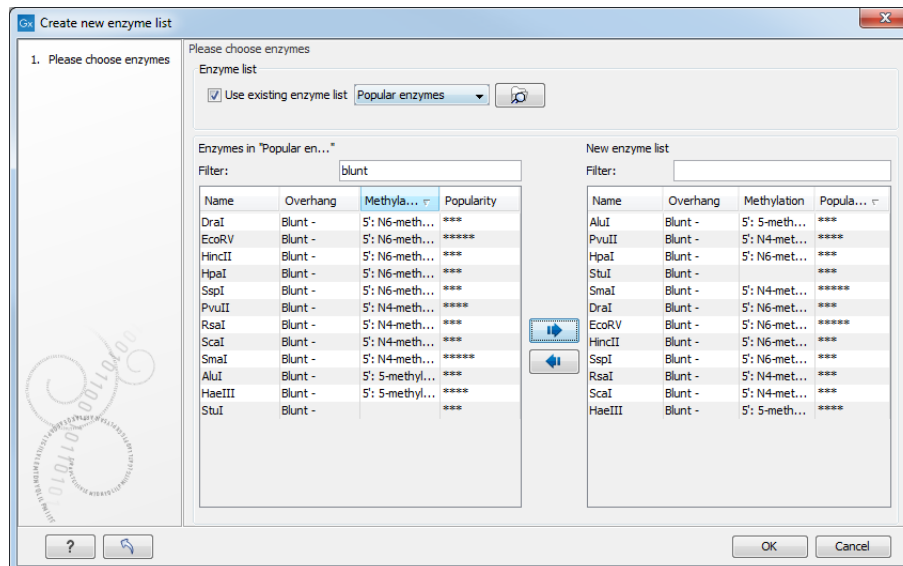

Figure 18.50: Selecting enzymes.

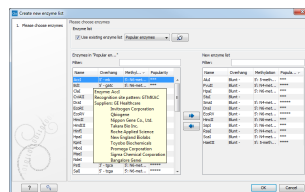

Figure 18.51: Showing additional information about an enzyme like recognition sequence or a list of commercial vendors.

18.5.2 View and modify enzyme list

An enzyme list is shown in figure 18.52.

The list can be sorted by clicking the columns,

Name	Recognition sequence	Length	Overhang	Suppliers
PstAI	gaattc	10	Blunt	GE Healthcare; Takara Bio Inc.; New England Biolabs
ClaI	atcgat	6	5' -cg	GE Healthcare; Invitrogen Corporation; American Alcol Biochemical, Inc.; Takara Bio Inc.; Roche Applied Science
Lba1534I	caactg	6	Blunt	
AatII	ggatcc	8	5' -at	New England Biolabs
MspI	ccggga	5	5' -c	GE Healthcare; Fermentas International Inc.; Qiagen; Takara Bio Inc.; Roche Applied Science; ThermoFisher Scientific
Msp113I	ccggga	6	5' -cg	SBEzyme Ltd.
Bcl2XI	gacGTC	4	5' -gac	
Bsp2095I	gatc	4	5' -gatc	
BclI	ccggga	6	5' -cggg	
Bss63I	cgatc	6	5' -cgatc	
MreI	ccggga	8	5' -cggg	
Bsp119I	ttgtaa	6	5' -cg	Fermentas International Inc.
BlnI	agact	6	Blunt	Vivantis Technologies
Sru300I	agcctt	6	Blunt	
Bur832I	gaagac	6	5' -<NA>	
Hpy118III	tcnaga	6	5' -tcn	
BlnI	actgga	6	5' -<NA>	SBEzyme Ltd.
Bsp7204E	ttgtaa	6	5' -cg	Takara Bio Inc.
Bss63I	cgatc	5	5' -tga	SBEzyme Ltd.; Vivantis Technologies
NdeI	ccggga	8	5' -ggcc	GE Healthcare; Invitrogen Corporation; Minotech Biotechnology; Fermentas International Inc.; Qiagen
SgrBI	ccggga	6	5' -gc	Minotech Biotechnology
Acl65I	gagctc	6	5' -gagc	
Bbv12I	ggagcc	6	5' -ggagc	SBEzyme Ltd.; Vivantis Technologies
BavAI	caactg	6	Blunt	
PstAI	gaattc	4	5' -at	

Figure 18.52: An enzyme list.

and you can use the filter at the top right corner to search for specific enzymes, recognition sequences etc.

If you wish to remove or add enzymes, click the **Add/Remove Enzymes** button at the bottom of the view. This will present the same dialog as shown in figure 18.49 with the enzyme list shown to the right.

If you wish to extract a subset of an enzyme list:

open the list | select the relevant enzymes | right-click | Create New Enzyme List from Selection 

If you combined this method with the filter located at the top of the view, you can extract a very specific set of enzymes. E.g. if you wish to create a list of enzymes sold by a particular distributor, type the name of the distributor into the filter, and select and create a new enzyme list from the selection.

Chapter 19

Sequence alignment

Contents

19.1 Create an alignment	468
19.1.1 Gap costs	469
19.1.2 Fast or accurate alignment algorithm	469
19.1.3 Aligning alignments	470
19.1.4 Fixpoints	471
19.2 View alignments	473
19.2.1 Bioinformatics explained: Sequence logo	475
19.3 Edit alignments	477
19.3.1 Move residues and gaps	477
19.3.2 Insert gaps	477
19.3.3 Delete residues and gaps	477
19.3.4 Copy annotations to other sequences	478
19.3.5 Move sequences up and down	478
19.3.6 Delete, rename and add sequences	479
19.3.7 Realignment	479
19.4 Join alignments	480
19.4.1 How alignments are joined	481
19.5 Pairwise comparison	482
19.5.1 Pairwise comparison on alignment selection	483
19.5.2 Pairwise comparison parameters	483
19.5.3 The pairwise comparison table	484
19.6 Bioinformatics explained: Multiple alignments	485
19.6.1 Use of multiple alignments	485
19.6.2 Constructing multiple alignments	486

CLC Genomics Workbench can align nucleotides and proteins using a *progressive alignment* algorithm (see section 19.6 or read the White paper on alignments in the **Science** section of <http://www.clcbio.com>).

This chapter describes how to use the program to align sequences. The chapter also describes alignment algorithms in more general terms.

19.1 Create an alignment

Alignments can be created from sequences, sequence lists (see section 10.6), existing alignments and from any combination of the three.

To create an alignment in *CLC Genomics Workbench*:

Toolbox | Classical Sequence Analysis (🗑️) | Alignments and Trees (📁) | Create Alignment (🔍)

This opens the dialog shown in figure 19.1.

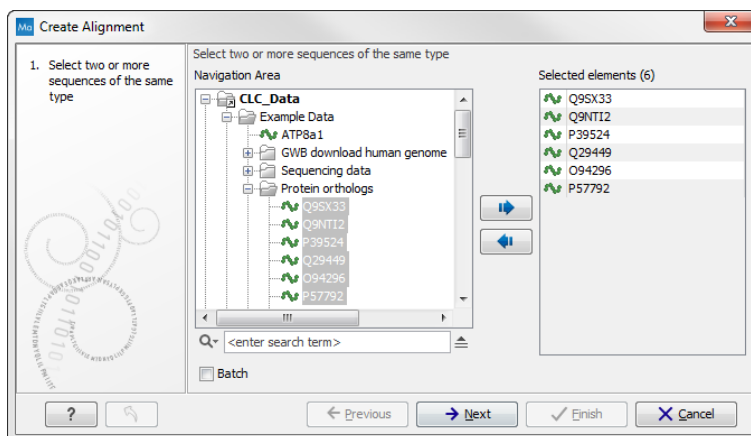

Figure 19.1: Creating an alignment.

If you have selected some elements before choosing the Toolbox action, they are now listed in the **Selected Elements** window of the dialog. Use the arrows to add or remove sequences, sequence lists or alignments from the selected elements. Click **Next** to adjust alignment algorithm parameters. Clicking **Next** opens the dialog shown in figure 19.2.

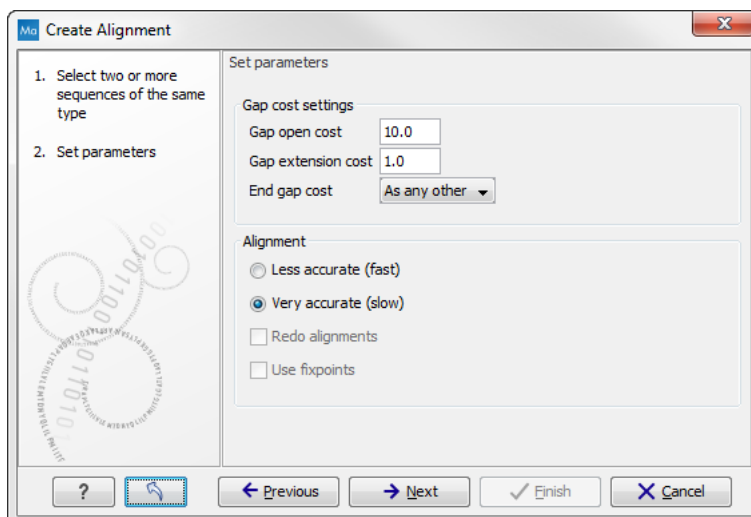

Figure 19.2: Adjusting alignment algorithm parameters.

19.1.1 Gap costs

The alignment algorithm has three parameters concerning gap costs: Gap open cost, Gap extension cost and End gap cost. The precision of these parameters is to one place of decimal.

- **Gap open cost.** The price for introducing gaps in an alignment.
- **Gap extension cost.** The price for every extension past the initial gap.

If you expect a lot of small gaps in your alignment, the Gap open cost should equal the Gap extension cost. On the other hand, if you expect few but large gaps, the Gap open cost should be set significantly higher than the Gap extension cost.

However, for most alignments it is a good idea to make the Gap open cost quite a bit higher than the Gap extension cost. The default values are 10.0 and 1.0 for the two parameters, respectively.

- **End gap cost.** The price of gaps at the beginning or the end of the alignment. One of the advantages of the *CLC Genomics Workbench* alignment method is that it provides flexibility in the treatment of gaps at the ends of the sequences. There are three possibilities:
 - **Free end gaps.** Any number of gaps can be inserted in the ends of the sequences without any cost.
 - **Cheap end gaps.** All end gaps are treated as gap extensions and any gaps past 10 are free.
 - **End gaps as any other.** Gaps at the ends of sequences are treated like gaps in any other place in the sequences.

When aligning a long sequence with a short partial sequence, it is ideal to use free end gaps, since this will be the best approximation to the situation. The many gaps inserted at the ends are not due to evolutionary events, but rather to partial data.

Many homologous proteins have quite different ends, often with large insertions or deletions. This confuses alignment algorithms, but using the **Cheap end gaps** option, large gaps will generally be tolerated at the sequence ends, improving the overall alignment. This is the default setting of the algorithm.

Finally, treating end gaps like any other gaps is the best option when you know that there are no biologically distinct effects at the ends of the sequences.

Figures 19.3 and 19.4 illustrate the differences between the different gap scores at the sequence ends.

19.1.2 Fast or accurate alignment algorithm

CLC Genomics Workbench has two algorithms for calculating alignments:

- **Fast (less accurate).** This allows for use of an optimized alignment algorithm which is very fast. The fast option is particularly useful for data sets with very long sequences.
- **Slow (very accurate).** This is the recommended choice unless you find the processing time too long.

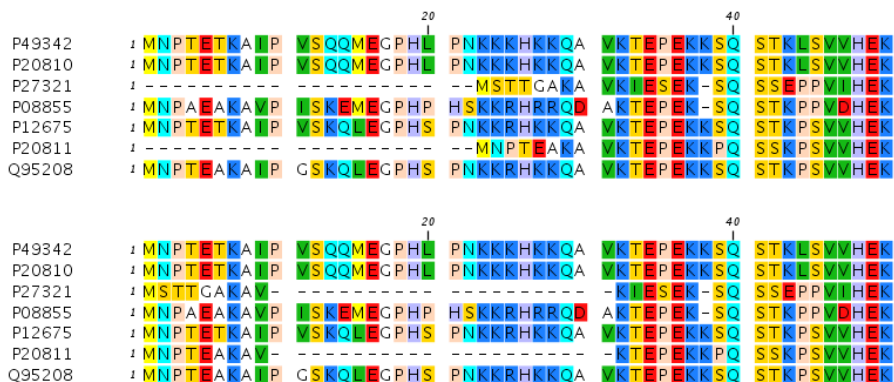

Figure 19.3: The first 50 positions of two different alignments of seven calpastatin sequences. The top alignment is made with cheap end gaps, while the bottom alignment is made with end gaps having the same price as any other gaps. In this case it seems that the latter scoring scheme gives the best result.

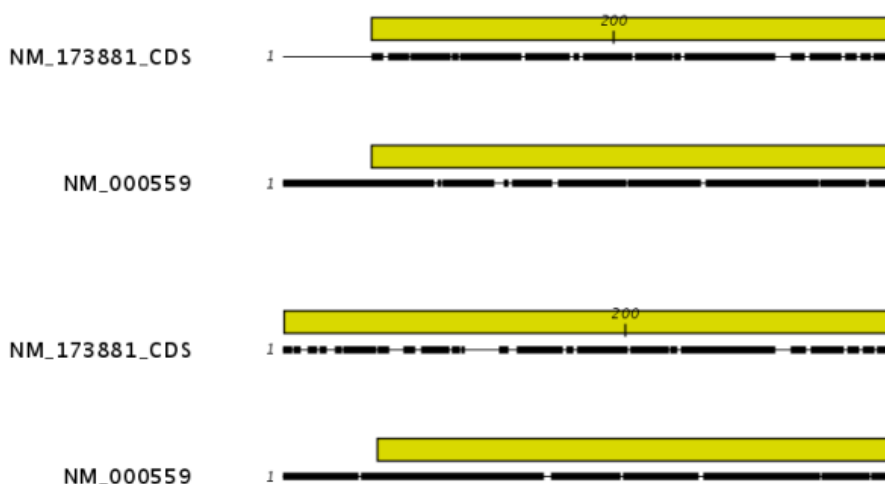

Figure 19.4: The alignment of the coding sequence of bovine myoglobin with the full mRNA of human gamma globin. The top alignment is made with free end gaps, while the bottom alignment is made with end gaps treated as any other. The yellow annotation is the coding sequence in both sequences. It is evident that free end gaps are ideal in this situation as the start codons are aligned correctly in the top alignment. Treating end gaps as any other gaps in the case of aligning distant homologs where one sequence is partial leads to a spreading out of the short sequence as in the bottom alignment.

Both algorithms use progressive alignment. The faster algorithm builds the initial tree by doing more approximate pairwise alignments than the slower option.

19.1.3 Aligning alignments

If you have selected an existing alignment in the first step (19.1), you have to decide how this alignment should be treated.

- **Redo alignment.** The original alignment will be realigned if this checkbox is checked. Otherwise, the original alignment is kept in its original form except for possible extra equally sized gaps in all sequences of the original alignment. This is visualized in figure 19.5.

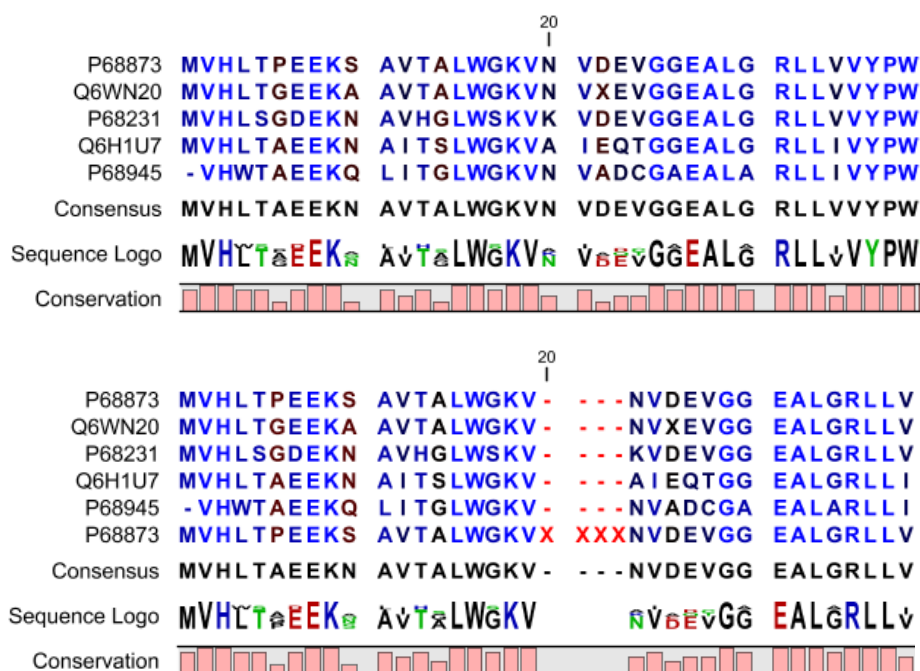

Figure 19.5: The top figures shows the original alignment. In the bottom panel a single sequence with four inserted X's are aligned to the original alignment. This introduces gaps in all sequences of the original alignment. All other positions in the original alignment are fixed.

This feature is useful if you wish to add extra sequences to an existing alignment, in which case you just select the alignment and the extra sequences and choose not to redo the alignment.

It is also useful if you have created an alignment where the gaps are not placed correctly. In this case, you can realign the alignment with different gap cost parameters.

19.1.4 Fixpoints

With fixpoints, you can get full control over the alignment algorithm. The fixpoints are points on the sequences that are forced to align to each other.

To add a fixpoint, open the sequence or alignment and:

Select the region you want to use as a fixpoint | right-click the selection | Set alignment fixpoint here

This will add an annotation labeled "Fixpoint" to the sequence (see figure 19.6). Use this procedure to add fixpoints to the other sequence(s) that should be forced to align to each other.

When you click "Create alignment" and go to **Step 2**, check **Use fixpoints** in order to force the alignment algorithm to align the fixpoints in the selected sequences to each other.

In figure 19.7 the result of an alignment using fixpoints is illustrated.

You can add multiple fixpoints, e.g. adding two fixpoints to the sequences that are aligned will force their first fixpoints to be aligned to each other, and their second fixpoints will also be aligned to each other.

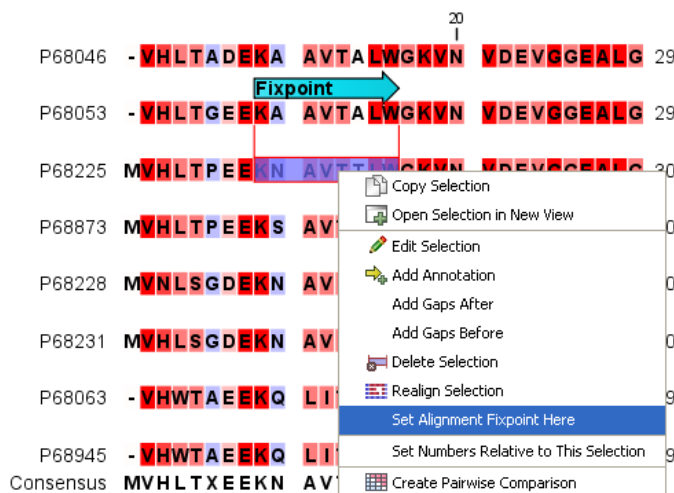

Figure 19.6: Adding a fixpoint to a sequence in an existing alignment. At the top you can see a fixpoint that has already been added.

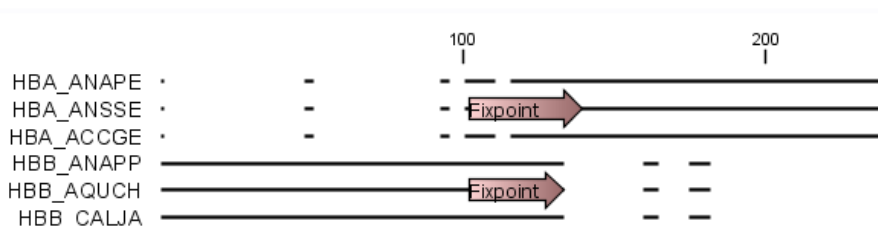
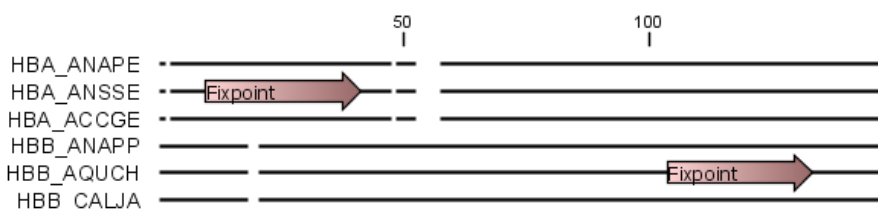

Figure 19.7: Realigning using fixpoints. In the top view, fixpoints have been added to two of the sequences. In the view below, the alignment has been realigned using the fixpoints. The three top sequences are very similar, and therefore they follow the one sequence (number two from the top) that has a fixpoint.

Advanced use of fixpoints

Fixpoints with the same names will be aligned to each other, which gives the opportunity for great control over the alignment process. It is only necessary to change any fixpoint names in very special cases.

One example would be three sequences A, B and C where sequences A and B has one copy of a domain while sequence C has two copies of the domain. You can now force sequence A to align to the first copy and sequence B to align to the second copy of the domains in sequence C. This is done by inserting fixpoints in sequence C for each domain, and naming them 'fp1' and 'fp2' (for example). Now, you can insert a fixpoint in each of sequences A and B, naming them 'fp1' and 'fp2', respectively. Now, when aligning the three sequences using fixpoints, sequence A will

align to the first copy of the domain in sequence C, while sequence B would align to the second copy of the domain in sequence C.

You can name fixpoints by:

right-click the Fixpoint annotation | Edit Annotation (👉) | type the name in the 'Name' field

19.2 View alignments

Since an alignment is a display of several sequences arranged in rows, the basic options for viewing alignments are the same as for viewing sequences. Therefore we refer to section [10.1](#) for an explanation of these basic options.

However, there are a number of alignment-specific view options in the **Alignment info** and the **Nucleotide info** in the **Side Panel** to the right of the view. Below is more information on these view options.

Under **Translation** in the **Nucleotide info**, there is an extra checkbox: **Relative to top sequence**. Checking this box will make the reading frames for the translation align with the top sequence so that you can compare the effect of nucleotide differences on the protein level.

The options in the **Alignment info** relate to each column in the alignment:

- **Consensus**. Shows a consensus sequence at the bottom of the alignment. The consensus sequence is based on every single position in the alignment and reflects an artificial sequence which resembles the sequence information of the alignment, but only as one single sequence. If all sequences of the alignment is 100% identical the consensus sequence will be identical to all sequences found in the alignment. If the sequences of the alignment differ the consensus sequence will reflect the most common sequences in the alignment. Parameters for adjusting the consensus sequences are described below.
 - **Limit**. This option determines how conserved the sequences must be in order to agree on a consensus. Here you can also choose **IUPAC** which will display the ambiguity code when there are differences between the sequences. E.g. an alignment with **A** and a **G** at the same position will display an **R** in the consensus line if the **IUPAC** option is selected. (The IUPAC codes can be found in section [H](#) and [G](#).) Please note that the IUPAC codes are only available for nucleotide alignments.
 - **No gaps**. Checking this option will not show gaps in the consensus.
 - **Ambiguous symbol**. Select how ambiguities should be displayed in the consensus line (as **N**, **?**, *****, **.** or **-**). This option has no effect if **IUPAC** is selected in the **Limit** list above.

The **Consensus Sequence** can be opened in a new view, simply by right-clicking the **Consensus Sequence** and click **Open Consensus in New View**.

- **Conservation**. Displays the level of conservation at each position in the alignment. The conservation shows the conservation of all sequence positions. The height of the bar, or the gradient of the color reflect how conserved that particular position is in the alignment. If one position is 100% conserved the bar will be shown in full height, and it is colored in the color specified at the right side of the gradient slider.

- **Foreground color.** Colors the letters using a gradient, where the right side color is used for highly conserved positions and the left side color is used for positions that are less conserved.
- **Background color.** Sets a background color of the residues using a gradient in the same way as described above.
- **Graph.** Displays the conservation level as a graph at the bottom of the alignment. The bar (default view) show the conservation of all sequence positions. The height of the graph reflects how conserved that particular position is in the alignment. If one position is 100% conserved the graph will be shown in full height. Learn how to export the data behind the graph in section 6.7.
 - * **Height.** Specifies the height of the graph.
 - * **Type.** The type of the graph.
 - **Line plot.** Displays the graph as a line plot.
 - **Bar plot.** Displays the graph as a bar plot.
 - **Colors.** Displays the graph as a color bar using a gradient like the foreground and background colors.
 - * **Color box.** Specifies the color of the graph for line and bar plots, and specifies a gradient for colors.
- **Gap fraction.** Which fraction of the sequences in the alignment that have gaps. The gap fraction is only relevant if there are gaps in the alignment.
 - **Foreground color.** Colors the letter using a gradient, where the left side color is used if there are relatively few gaps, and the right side color is used if there are relatively many gaps.
 - **Background color.** Sets a background color of the residues using a gradient in the same way as described above.
 - **Graph.** Displays the gap fraction as a graph at the bottom of the alignment (Learn how to export the data behind the graph in section 6.7).
 - * **Height.** Specifies the height of the graph.
 - * **Type.** The type of the graph.
 - **Line plot.** Displays the graph as a line plot.
 - **Bar plot.** Displays the graph as a line plot.
 - **Colors.** Displays the graph as a color bar using a gradient like the foreground and background colors.
 - * **Color box.** Specifies the color of the graph for line and bar plots, and specifies a gradient for colors.
- **Color different residues.** Indicates differences in aligned residues.
 - **Foreground color.** Colors the letter.
 - **Background color.** Sets a background color of the residues.
- **Sequence logo.** A sequence logo displays the frequencies of residues at each position in an alignment. This is presented as the relative heights of letters, along with the degree of sequence conservation as the total height of a stack of letters, measured in bits of information. The vertical scale is in bits, with a maximum of 2 bits for nucleotides and approximately 4.32 bits for amino acid residues. See section 19.2.1 for more details.

- **Foreground color.** Color the residues using a gradient according to the information content of the alignment column. Low values indicate columns with high variability whereas high values indicate columns with similar residues.
- **Background color.** Sets a background color of the residues using a gradient in the same way as described above.
- **Logo.** Displays sequence logo at the bottom of the alignment.
 - * **Height.** Specifies the height of the sequence logo graph.
 - * **Color.** The sequence logo can be displayed in black or Rasmol colors. For protein alignments, a polarity color scheme is also available, where hydrophobic residues are shown in black color, hydrophilic residues as green, acidic residues as red and basic residues as blue.

19.2.1 Bioinformatics explained: Sequence logo

In the search for homologous sequences, researchers are often interested in conserved sites/residues or positions in a sequence which tend to differ a lot. Most researchers use alignments (see Bioinformatics explained: *multiple alignments*) for visualization of homology on a given set of either DNA or protein sequences. In proteins, active sites in a given protein family are often highly conserved. Thus, in an alignment these positions (which are not necessarily located in proximity) are fully or nearly fully conserved. On the other hand, antigen binding sites in the F_{ab} unit of immunoglobulins tend to differ quite a lot, whereas the rest of the protein remains relatively unchanged.

In DNA, promoter sites or other DNA binding sites are highly conserved (see figure 19.8). This is also the case for repressor sites as seen for the Cro repressor of bacteriophage λ .

When aligning such sequences, regardless of whether they are highly variable or highly conserved at specific sites, it is very difficult to generate a consensus sequence which covers the actual variability of a given position. In order to better understand the information content or significance of certain positions, a sequence logo can be used. The sequence logo displays the information content of all positions in an alignment as residues or nucleotides stacked on top of each other (see figure 19.8). The sequence logo provides a far more detailed view of the entire alignment than a simple consensus sequence. Sequence logos can aid to identify protein binding sites on DNA sequences and can also aid to identify conserved residues in aligned domains of protein sequences and a wide range of other applications.

Each position of the alignment and consequently the sequence logo shows the sequence information in a computed score based on Shannon entropy [Schneider and Stephens, 1990]. The height of the individual letters represent the sequence information content in that particular position of the alignment.

A sequence logo is a much better visualization tool than a simple consensus sequence. An example hereof is an alignment where in one position a particular residue is found in 70% of the sequences. If a consensus sequence is used, it typically only displays the single residue with 70% coverage. In figure 19.8 an un-gapped alignment of 11 *E. coli* start codons including flanking regions are shown. In this example, a consensus sequence would only display ATG as the start codon in position 1, but when looking at the sequence logo it is seen that a GTG is also allowed as a start codon.

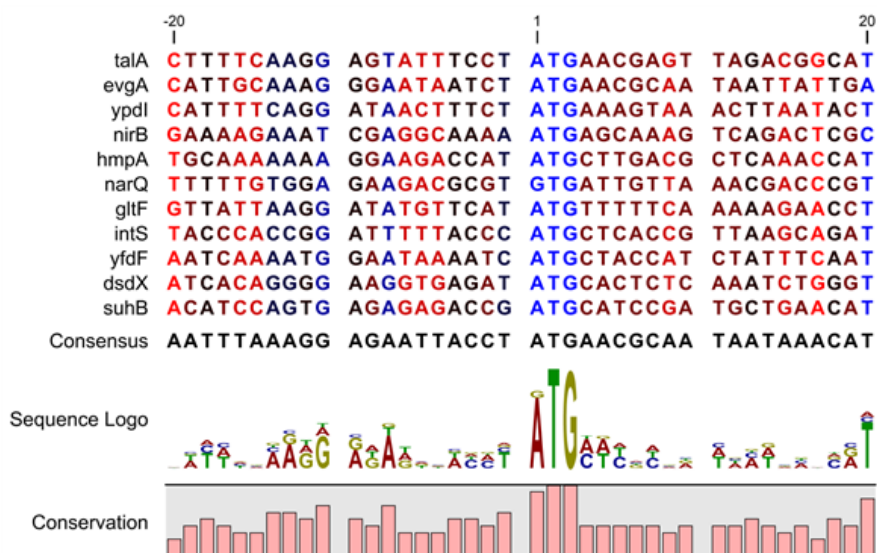

Figure 19.8: Ungapped sequence alignment of eleven *E. coli* sequences defining a start codon. The start codons start at position 1. Below the alignment is shown the corresponding sequence logo. As seen, a GTG start codon and the usual ATG start codons are present in the alignment. This can also be visualized in the logo at position 1.

Calculation of sequence logos

A comprehensive walk-through of the calculation of the information content in sequence logos is beyond the scope of this document but can be found in the original paper by [Schneider and Stephens, 1990]. Nevertheless, the conservation of every position is defined as R_{seq} which is the difference between the maximal entropy (S_{max}) and the observed entropy for the residue distribution (S_{obs}),

$$R_{seq} = S_{max} - S_{obs} = \log_2 N - \left(- \sum_{n=1}^N p_n \log_2 p_n \right)$$

p_n is the observed frequency of a amino acid residue or nucleotide of symbol n at a particular position and N is the number of distinct symbols for the sequence alphabet, either 20 for proteins or four for DNA/RNA. This means that the maximal sequence information content per position is $\log_2 4 = 2 \text{ bits}$ for DNA/RNA and $\log_2 20 \approx 4.32 \text{ bits}$ for proteins.

The original implementation by Schneider does not handle sequence gaps.

We have slightly modified the algorithm so an estimated logo is presented in areas with sequence gaps.

If amino acid residues or nucleotides of one sequence are found in an area containing gaps, we have chosen to show the particular residue as the fraction of the sequences. Example; if one position in the alignment contain 9 gaps and only one alanine (A) the A represented in the logo has a hight of 0.1.

Other useful resources

The website of Tom Schneider

<http://www-lmmb.ncifcrf.gov/~toms/>

WebLogo

<http://weblogo.berkeley.edu/>

[Crooks et al., 2004]

19.3 Edit alignments

19.3.1 Move residues and gaps

The placement of gaps in the alignment can be changed by modifying the parameters when creating the alignment (see section 19.1). However, gaps and residues can also be moved after the alignment is created:

select one or more gaps or residues in the alignment | drag the selection to move

This can be done both for single sequences, but also for multiple sequences by making a selection covering more than one sequence. When you have made the selection, the mouse pointer turns into a horizontal arrow indicating that the selection can be moved (see figure 19.9).

Note! Residues can only be moved when they are next to a gap.

```

AGG GAGTCAT      AGG GAGTCAT
AGG GAGTCAT      AGG GAGTCAT
AGG GAGCAGT      AGG GAGCAGT
- - - - -        - - - - -
AGG GTACAGT      AGG GTACAGT
- - - GAGTAGC    - GA G - - TAGC
- - - GAGTAGC    - GA G - - TAGC
- - - GAGTAGC    - GA G - - TAGG
ATG GTGCACC      ATG GTGCACC
ATG GTGCATC      ATG GTGCATC
  
```

Figure 19.9: *Moving a part of an alignment. Notice the change of mouse pointer to a horizontal arrow.*

19.3.2 Insert gaps

The placement of gaps in the alignment can be changed by modifying the parameters when creating the alignment. However, gaps can also be added manually after the alignment is created.

To insert extra gaps:

select a part of the alignment | right-click the selection | Add gaps before/after

If you have made a selection covering e.g. five residues, a gap of five will be inserted. In this way you can easily control the number of gaps to insert. Gaps will be inserted in the sequences that you selected. If you make a selection in two sequences in an alignment, gaps will be inserted into these two sequences. This means that these two sequences will be displaced compared to the other sequences in the alignment.

19.3.3 Delete residues and gaps

Residues or gaps can be deleted for individual sequences or for the whole alignment. For individual sequences:

select the part of the sequence you want to delete | right-click the selection | Edit Selection () | Delete the text in the dialog | Replace

The selection shown in the dialog will be replaced by the text you enter. If you delete the text, the selection will be replaced by an empty text, i.e. deleted.

In order to delete entire columns:

manually select the columns to delete | right-click the selection | click 'Delete Selection'

19.3.4 Copy annotations to other sequences

Annotations on one sequence can be transferred to other sequences in the alignment:

right-click the annotation | Copy Annotation to other Sequences

This will display a dialog listing all the sequences in the alignment. Next to each sequence is a checkbox which is used for selecting which sequences, the annotation should be copied to. Click **Copy** to copy the annotation.

If you wish to copy all annotations on the sequence, click the **Copy All Annotations to other Sequences**.

Copied/transferred annotations will contain the same qualifier text as the original. That is, the text is not updated. As an example, if the annotation contains 'translation' as qualifier text this translation will be copied to the new sequence and will thus reflect the translation of the original sequence, not the new sequence, which may differ.

19.3.5 Move sequences up and down

Sequences can be moved up and down in the alignment:

drag the name of the sequence up or down

When you move the mouse pointer over the label, the pointer will turn into a vertical arrow indicating that the sequence can be moved.

The sequences can also be sorted automatically to let you save time moving the sequences around. To sort the sequences alphabetically:

Right-click the name of a sequence | Sort Sequences Alphabetically

If you change the Sequence name (in the **Sequence Layout** view preferences), you will have to ask the program to sort the sequences again.

If you have one particular sequence that you would like to use as a reference sequence, it can be useful to move this to the top. This can be done manually, but it can also be done automatically:

Right-click the name of a sequence | Move Sequence to Top

The sequences can also be sorted by similarity, grouping similar sequences together:

Right-click the name of a sequence | Sort Sequences by Similarity

19.3.6 Delete, rename and add sequences

Sequences can be removed from the alignment by right-clicking the label of a sequence:

right-click label | Delete Sequence

This can be undone by clicking **Undo** (↶) in the Toolbar.

If you wish to delete several sequences, you can check all the sequences, right-click and choose **Delete Marked Sequences**. To show the checkboxes, you first have to click the **Show Selection Boxes** in the **Side Panel**.

A sequence can also be renamed:

right-click label | Rename Sequence

This will show a dialog, letting you rename the sequence. This will not affect the sequence that the alignment is based on.

Extra sequences can be added to the alignment by creating a new alignment where you select the current alignment and the extra sequences (see section 19.1).

The same procedure can be used for joining two alignments.

19.3.7 Realignment

Realigning a section of an alignment

If you have created an alignment, it is possible to realign a part of it, leaving the rest of the alignment unchanged:

Select a part of the alignment to realign | Right-click the selection | Choose the option "Realign selection"

This will open a window allowing you to set the parameters for the realignment (see figure 19.10).

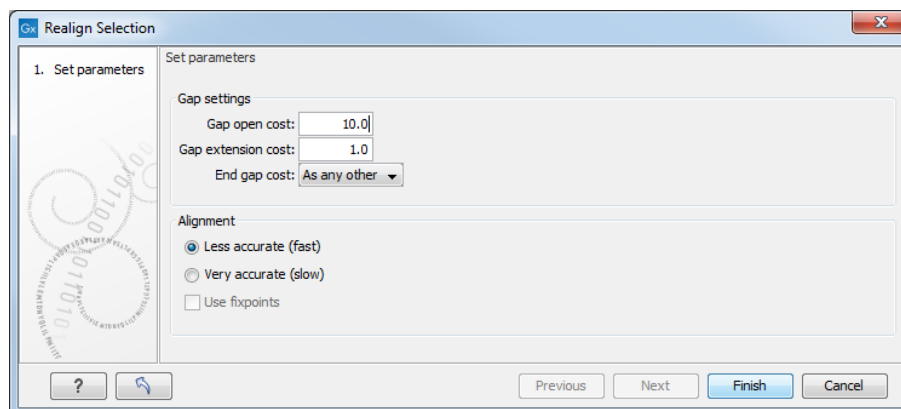

Figure 19.10: *Realigning a section of an alignment.*

Learn more about the options available to you in the sections 19.1.1 and 19.1.2.

It is possible for an alignment to become shorter or longer as a result of the realignment of a region. This is because gaps may have to be inserted in, or deleted from, the sequences not selected for realignment. This will only occur for entire columns of gaps in these sequences, ensuring that their relative alignment is unchanged.

Realigning a selection is a very powerful tool for editing alignments in several situations:

- **Removing changes.** If you change the alignment in a specific region manually but decide to undo all the edits you just made, you can easily select the region that was edited and realign it.
- **Adjusting the number of gaps.** If you have a region in an alignment which has too many gaps, you can select the region and realign it with a higher gap cost.
- **Combine with fixpoints.** When you have an alignment where two residues are not aligned although they should have been, you can set an alignment fixpoint on each of the two residues, select the region and realign it using the fixpoints. Now, the two residues are aligned with each other and everything in the selected region around them is adjusted to accommodate this change.

Realigning a subset of aligned sequences

To realign only a subset of the sequences of an alignment, you have to select the sequences you want to realign by click-and-drag on their entire length, and open the selection in a new view. This means that the sequences you want to select need to be situated on top of each other in a single stack.

A small stack is easily obtainable by dragging the sequences by their names to the top of the alignment. But when a large quantity of sequences needs to be moved to sit together, we recommend using the selection boxes that are available when checking the option "Show selection boxes" from the Alignment settings section in the right-hand side panel (figure 19.11). Select all the sequences you want to realign independently of the rest of the alignment, and right-click on the name of one of the sequences to choose the option "Sort Sequences by Marked Status". This will bring all checkbox-selected items to the top of the alignment.

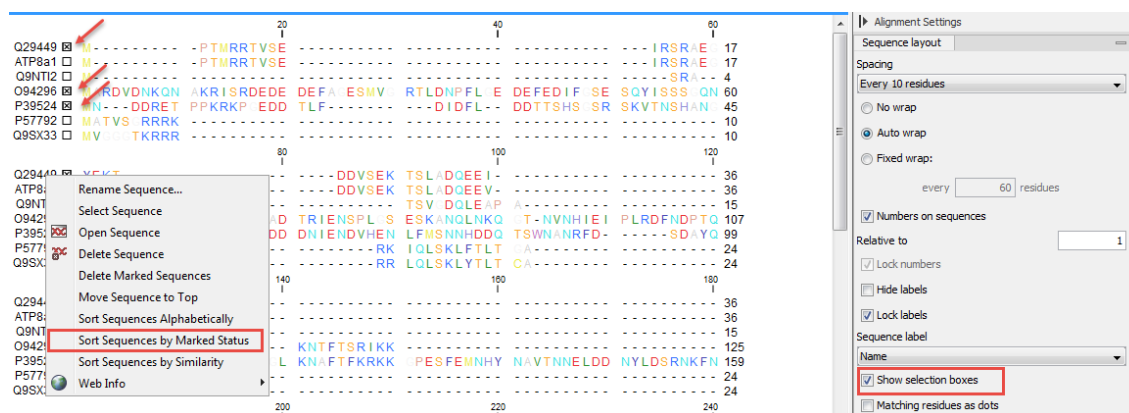

Figure 19.11: Realigning a subset of the sequences that are part of an alignment. Note that we can see here the menu available when right clicking on the names of the sequences.

You can then easily click-and-drag your selection of sequences (this is made easier if you select the "No wrap" setting in the right-hand side panel). By right-clicking on the selected sequences (not on their names, but on the sequences themselves as seen in figure 19.12), you can choose the option "Open selection in a new view", with the ability to run any relevant tool on that sub-alignment.

19.4 Join alignments

CLC Genomics Workbench can join several alignments into one. This feature can for example

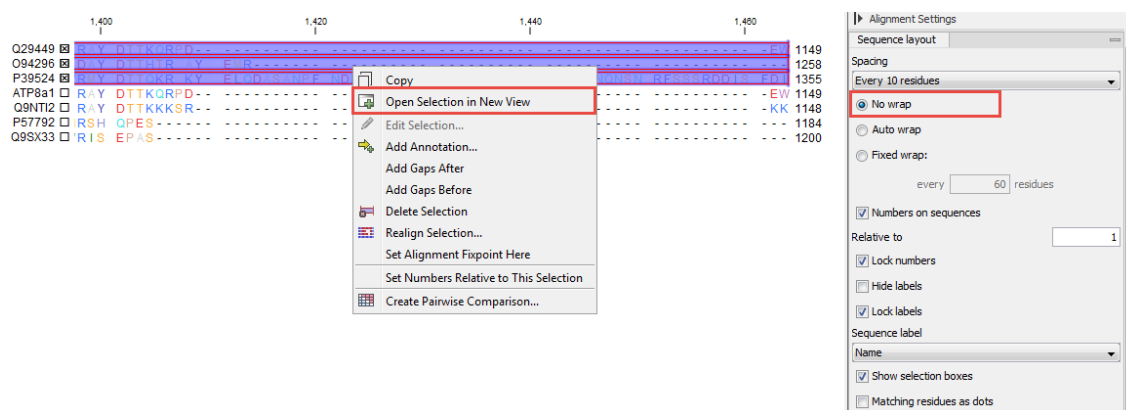

Figure 19.12: Open the selected sequences in a new window to realign them.

be used to construct "supergenes" for phylogenetic inference by joining alignments of several disjoint genes into one spliced alignment. Note, that when alignments are joined, all their annotations are carried over to the new spliced alignment.

Alignments can be joined by:

Toolbox | Classical Sequence Analysis (🔍) | Alignments and Trees (📄) | Join Alignments (🔗)

This opens the dialog shown in figure 19.13.

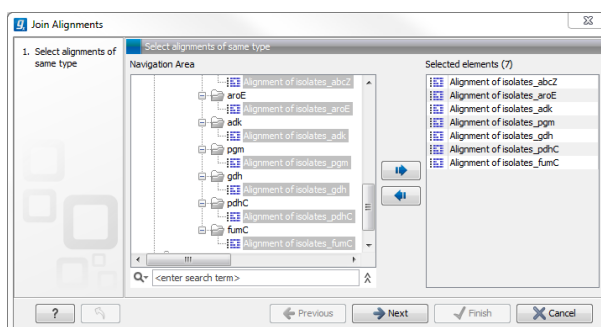

Figure 19.13: Selecting two alignments to be joined.

If you have selected some alignments before choosing the Toolbox action, they are now listed in the **Selected Elements** window of the dialog. Use the arrows to add or remove alignments from the selected elements. In this example seven alignments are selected. Each alignment represents one gene that have been sequenced from five different bacterial isolates from the genus *Nisseria*. Clicking **Next** opens the dialog shown in figure 19.14.

To adjust the order of concatenation, click the name of one of the alignments, and move it up or down using the arrow buttons.

The result is seen in the lower part of figure 19.15.

19.4.1 How alignments are joined

Alignments are joined by considering the sequence names in the individual alignments. If two sequences from different alignments have identical names, they are considered to have the same origin and are thus joined. Consider the joining of the alignments shown in figure 19.15

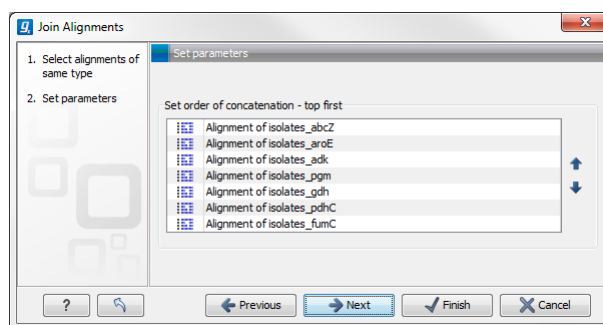

Figure 19.14: Selecting order of concatenation.

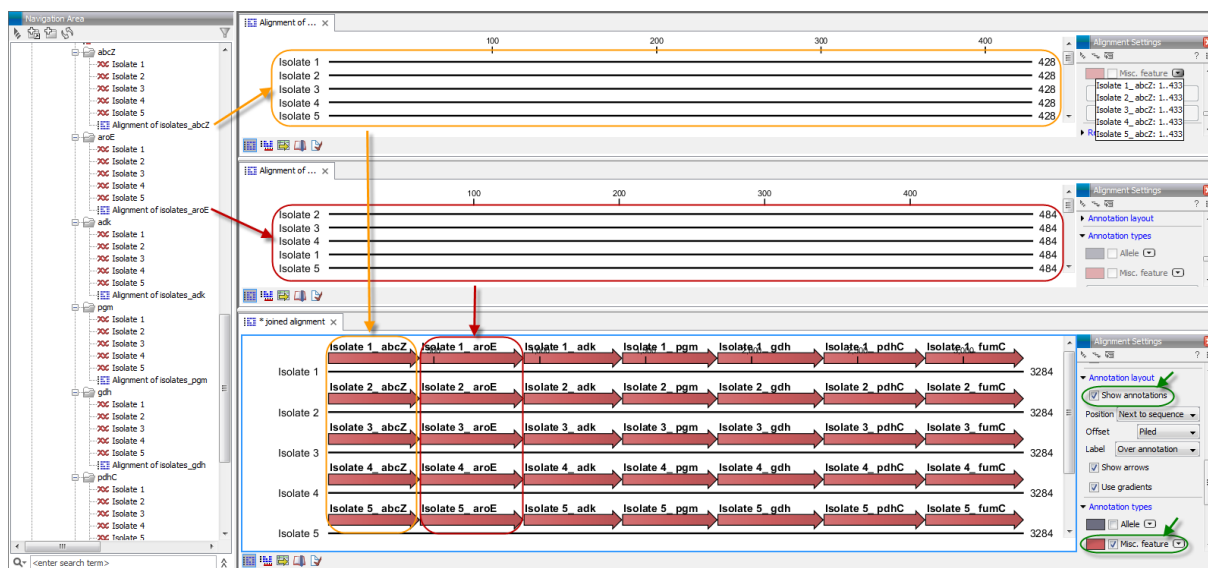

Figure 19.15: The upper part of the figure shows two of the seven alignments for the genes "abcZ" and "aroE" respectively. Each alignment consists of sequences from one gene from five different isolates. The lower part of the figure shows the result of "Join Alignments". Seven genes have been joined to an artificial gene fusion, which can be useful for construction of phylogenetic trees in cases where only fractions of a genome is available. Joining of the alignments results in one row for each isolate consisting of seven fused genes. Each fused gene sequence corresponds to the number of uniquely named sequences in the joined alignments.

"Alignment of isolates_abcZ", "Alignment of isolates_aroE", "Alignment of isolates_adk" etc. If a sequence with the same name is found in the different alignments (in this case the name of the isolates: Isolate 1, Isolate 2, Isolate 3, Isolate 4, and Isolate 5), a joined alignment will exist for each sequence name. In the joined alignment the selected alignments will be fused with each other in the order they were selected (in this case the seven different genes from the five bacterial isolates). Note that annotations have been added to each individual sequence before aligning the isolates for one gene at the time in order to make it clear which sequences were fused to each other.

19.5 Pairwise comparison

For a given set of aligned sequences it is possible to make a pairwise comparison in which each pair of sequences are compared to each other. This provides an overview of the diversity among the sequences in the alignment.

In *CLC Genomics Workbench* this is done by creating a comparison table:

Toolbox | Classical Sequence Analysis (🗑️) | Alignments and Trees (📁) | Create Pairwise Comparison (📊)

This opens the dialog displayed in figure 19.16:

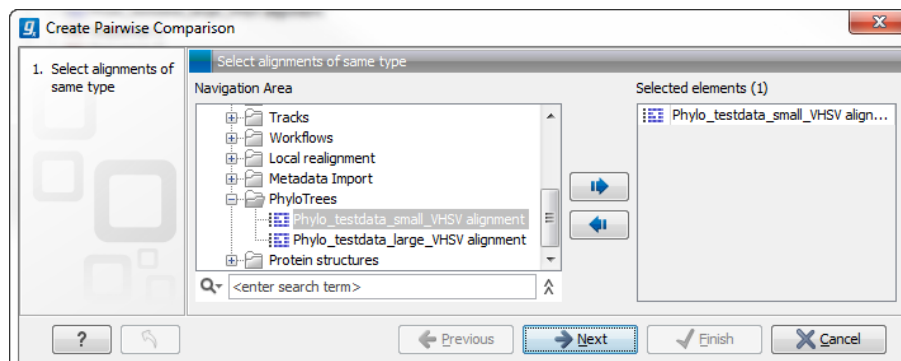

Figure 19.16: Creating a pairwise comparison table.

If an alignment was selected before choosing the Toolbox action, this alignment is now listed in the **Selected Elements** window of the dialog. Use the arrows to add or remove elements from the **Navigation Area**. Click **Next** to adjust parameters.

19.5.1 Pairwise comparison on alignment selection

A pairwise comparison can also be performed for a selected part of an alignment:

right-click on an alignment selection | Pairwise Comparison (📊)

This leads directly to the dialog described in the next section.

19.5.2 Pairwise comparison parameters

There are five kinds of comparison that can be made between the sequences in the alignment, as shown in figure 19.17.

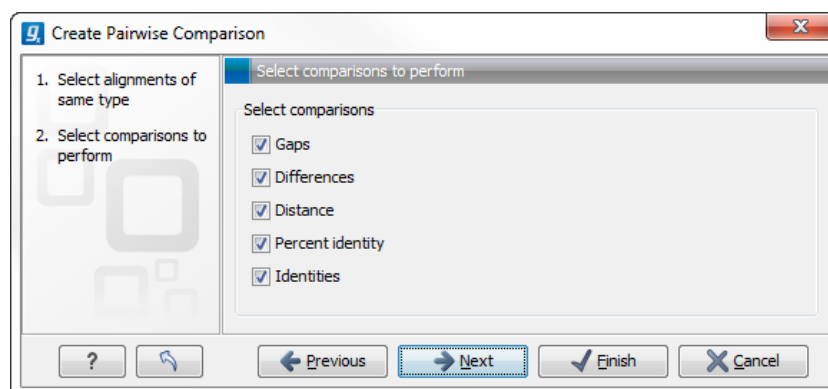

Figure 19.17: Adjusting parameters for pairwise comparison.

- **Gaps** Calculates the number of alignment positions where one sequence has a gap and the other does not.

- **Identities** Calculates the number of identical alignment positions to overlapping alignment positions between the two sequences. An overlapping alignment position is a position where at least one residue is present, rather than only gaps.
- **Differences** Calculates the number of alignment positions where one sequence is different from the other. This includes gap differences as in the Gaps comparison.
- **Distance** Calculates the Jukes-Cantor distance between the two sequences. This number is given as the Jukes-Cantor correction of the proportion between identical and overlapping alignment positions between the two sequences.
- **Percent identity** Calculates the percentage of identical residues in alignment positions to overlapping alignment positions between the two sequences.

19.5.3 The pairwise comparison table

The table shows the results of selected comparisons (see an example in figure 19.18). Since comparisons are often symmetric, the table can show the results of two comparisons at the same time, one in the upper-right and one in the lower-left triangle.

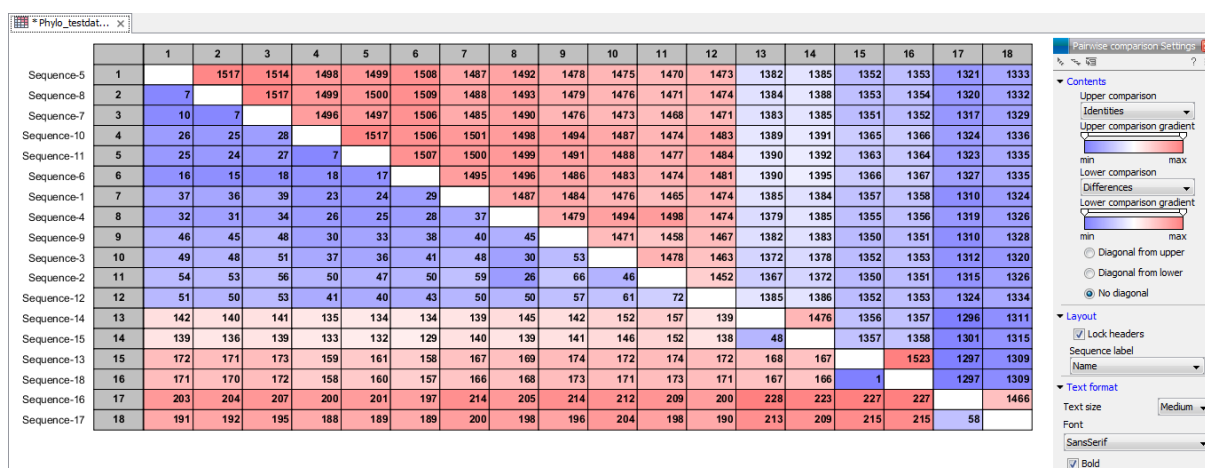

Figure 19.18: A pairwise comparison table.

Note that you can change the minimum and maximum values of the gradient coloring by sliding the corresponding cursor along the gradient in the right side panel of the comparison table. The values that appears when you slide the cursor reflect the percentage of the range of values in the table, and not absolute values.

The following settings are present in the side panel:

- **Contents**
 - **Upper comparison** Selects the comparison to show in the upper triangle of the table.
 - **Upper comparison gradient** Selects the color gradient to use for the upper triangle.
 - **Lower comparison** Selects the comparison to show in the lower triangle. Choose the same comparison as in the upper triangle to show all the results of an asymmetric comparison.

- **Lower comparison gradient** Selects the color gradient to use for the lower triangle.
 - **Diagonal from upper** Use this setting to show the diagonal results from the upper comparison.
 - **Diagonal from lower** Use this setting to show the diagonal results from the lower comparison.
 - **No Diagonal.** Leaves the diagonal table entries blank.
- **Layout**
 - **Lock headers** Locks the sequence labels and table headers when scrolling the table.
 - **Sequence label** Changes the sequence labels.
 - **Text format**
 - **Text size** Changes the size of the table and the text within it.
 - **Font** Changes the font in the table.
 - **Bold** Toggles the use of boldface in the table.

19.6 Bioinformatics explained: Multiple alignments

Multiple alignments are at the core of bioinformatical analysis. Often the first step in a chain of bioinformatical analyses is to construct a multiple alignment of a number of homologs DNA or protein sequences. However, despite their frequent use, the development of multiple alignment algorithms remains one of the algorithmically most challenging areas in bioinformatical research.

Constructing a multiple alignment corresponds to developing a hypothesis of how a number of sequences have evolved through the processes of character substitution, insertion and deletion. The input to multiple alignment algorithms is a number of homologous sequences i.e. sequences that share a common ancestor and most often also share molecular function. The generated alignment is a table (see figure 19.19) where each row corresponds to an input sequence and each column corresponds to a position in the alignment. An individual column in this table represents residues that have all diverged from a common ancestral residue. Gaps in the table (commonly represented by a '-') represent positions where residues have been inserted or deleted and thus do not have ancestral counterparts in all sequences.

19.6.1 Use of multiple alignments

Once a multiple alignment is constructed it can form the basis for a number of analyses:

- The phylogenetic relationship of the sequences can be investigated by tree-building methods based on the alignment.
- Annotation of functional domains, which may only be known for a subset of the sequences, can be transferred to aligned positions in other un-annotated sequences.
- Conserved regions in the alignment can be found which are prime candidates for holding functionally important sites.
- Comparative bioinformatical analysis can be performed to identify functionally important regions.

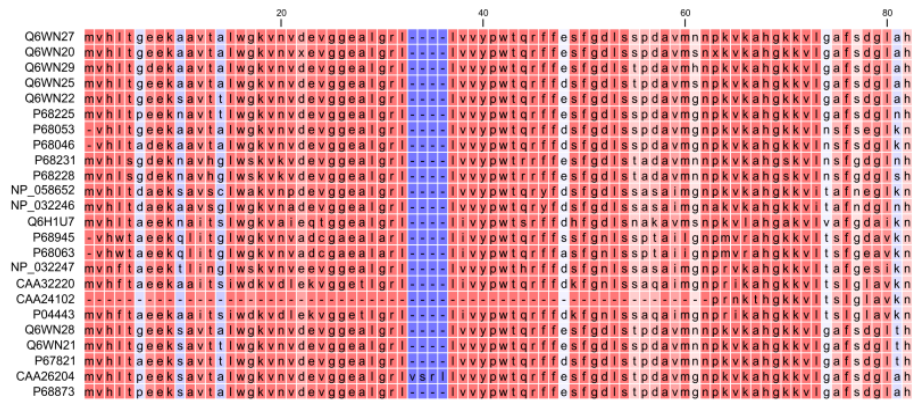

Figure 19.19: The tabular format of a multiple alignment of 24 Hemoglobin protein sequences. Sequence names appear at the beginning of each row and the residue position is indicated by the numbers at the top of the alignment columns. The level of sequence conservation is shown on a color scale with blue residues being the least conserved and red residues being the most conserved.

19.6.2 Constructing multiple alignments

Whereas the optimal solution to the pairwise alignment problem can be found in reasonable time, the problem of constructing a multiple alignment is much harder.

The first major challenge in the multiple alignment procedure is how to rank different alignments i.e. which *scoring function* to use. Since the sequences have a shared history they are correlated through their *phylogeny* and the scoring function should ideally take this into account. Doing so is, however, not straightforward as it increases the number of model parameters considerably. It is therefore commonplace to either ignore this complication and assume sequences to be unrelated, or to use heuristic corrections for shared ancestry.

The second challenge is to find the optimal alignment given a scoring function. For pairs of sequences this can be done by *dynamic programming* algorithms, but for more than three sequences this approach demands too much computer time and memory to be feasible.

A commonly used approach is therefore to do *progressive alignment* [Feng and Doolittle, 1987] where multiple alignments are built through the successive construction of pairwise alignments. These algorithms provide a good compromise between time spent and the quality of the resulting alignment

Presently, the most exciting development in multiple alignment methodology is the construction of *statistical alignment* algorithms [Hein, 2001], [Hein et al., 2000]. These algorithms employ a scoring function which incorporates the underlying phylogeny and use an explicit stochastic model of molecular evolution which makes it possible to compare different solutions in a statistically rigorous way. The optimization step, however, still relies on dynamic programming and practical use of these algorithms thus awaits further developments.

Chapter 20

Phylogenetic trees

Contents

20.1 Phylogenetic tree features	487
20.2 Create Trees	489
20.2.1 K-mer Based Tree Construction	489
20.2.2 Create tree	491
20.2.3 Model Testing	492
20.2.4 Maximum Likelihood Phylogeny	494
20.2.5 Bioinformatics explained	497
20.3 Tree Settings	503
20.3.1 Minimap	504
20.3.2 Tree layout	504
20.3.3 Node settings	505
20.3.4 Label settings	506
20.3.5 Background settings	507
20.3.6 Branch layout	507
20.3.7 Bootstrap settings	509
20.3.8 Visualizing metadata	510
20.3.9 Node right click menu	510
20.4 Metadata and phylogenetic trees	512
20.4.1 Table Settings and Filtering	513
20.4.2 Add or modify metadata on a tree	514
20.4.3 Undefined metadata values on a tree	515
20.4.4 Selection of specific nodes	516

20.1 Phylogenetic tree features

Phylogenetics describes the taxonomical classification of organisms based on their evolutionary history i.e. their phylogeny. Phylogenetics is therefore an integral part of the science of systematics that aims to establish the phylogeny of organisms based on their characteristics. Furthermore, phylogenetics is central to evolutionary biology as a whole as it is the condensation

of the overall paradigm of how life arose and developed on earth. The focus of this module is the reconstruction and visualization of phylogenetic trees. Phylogenetic trees illustrate the inferred evolutionary history of a set of organisms, and makes it possible to e.g. identify groups of closely related organisms and observe clustering of organisms with common traits. See [20.2.5](#) for a more detailed introduction to phylogenetic trees.

The viewer for visualizing and working with phylogenetic trees allows the user to create high-quality, publication-ready figures of phylogenetic trees. Large trees can be explored in two alternative tree layouts; circular and radial. The viewer supports importing, editing and visualization of metadata associated with nodes in phylogenetic trees.

Below is an overview of the main features of the phylogenetic tree editor. Further details can be found in the subsequent sections.

Main features of the phylogenetic tree editor:

- Circular and radial layouts.
- Import of metadata in Excel and CSV format.
- Tabular view of metadata with support for editing.
- Options for collapsing nodes based on bootstrap values.
- Re-ordering of tree nodes.
- Legends describing metadata.
- Visualization of metadata though e.g. node color, node shape, branch color, etc.
- Minimap navigation.
- Coloring and labeling of subtrees.
- Curved edges.
- Editable node sizes and line width.
- Intelligent visualization of overlapping labels and nodes.

The viewer for visualizing and working with phylogenetic trees allows the user to create high-quality, publication-ready figures of phylogenetic trees. Large trees can be explored in two alternative tree layouts; circular and radial.

Below is an overview of the main features of the phylogenetic tree editor. Further details can be found in the subsequent sections.

Main features of the phylogenetic tree editor:

- Circular and radial layouts.
- Options for collapsing nodes based on bootstrap values.
- Re-ordering of tree nodes.
- Minimap navigation.

- Coloring and labeling of subtrees.
- Curved edges.
- Editable node sizes and line width.
- Intelligent visualization of overlapping labels and nodes.

20.2 Create Trees

For a given set of aligned sequences (see section 19.1) it is possible to infer their evolutionary relationships. In *CLC Genomics Workbench* this may be done using one of two distance based methods (see "Bioinformatics explained" in section 20.2.5).

For a given set of aligned sequences (see section 19.1) it is possible to infer their evolutionary relationships. In *CLC Genomics Workbench* this may be done either by using a distance based method or by using maximum likelihood (ML) estimation, which is a statistical approach (see "Bioinformatics explained" in section 20.2.5). Both approaches generate a phylogenetic tree.

Three tools are available for generating phylogenetic trees:

- **K-mer Based Tree Construction** (🌲): Is a distance-based method that can create trees based on multiple single sequences. K-mers are used to compute distance matrices for distance-based phylogenetic reconstruction tools such as neighbor joining and UPGMA (see section 20.2.5). This method is less precise than the "Create Tree" tool but it can cope with a very large number of long sequences as it does not require a multiple alignment. The k-mer based tree construction tool is especially useful for whole genome phylogenetic reconstruction where the genomes are closely related, i.e. they differ mainly by SNPs and contain no or few structural variations.
- **Maximum Likelihood Phylogeny** (🌲): The most advanced and time consuming method of the three mentioned. The maximum likelihood tree estimation is performed under the assumption of one of five substitution models: the Jukes-Cantor, the Kimura 80, the HKY and the GTR (also known as the REV model) models (see section 20.2.4 for further information about the models). Prior to using the "Maximum Likelihood Phylogeny" tool for creating a phylogenetic tree it is recommended to run the "Model Testing" tool (see section 20.2.3) in order to identify the best suitable models for creating a tree.
- **Create Tree** (🌲): Is a tool that uses distance estimates computed from multiple alignments to create trees. The user can select whether to use Jukes-Cantor distance correction or Kimura distance correction (Kimura 80 for nucleotides/Kimura protein for proteins) in combination with either the neighbor joining or UPGMA method (see section 20.2.5).

20.2.1 K-mer Based Tree Construction

The "K-mer Based Tree Construction" uses single sequences or sequence lists as input and is the simplest way of creating a distance-based phylogenetic tree. To run the "K-mer Based Tree Construction" tool:

Toolbox | **Classical Sequence Analysis** (📁) | **Alignments and Trees** (📁) | **K-mer Based Tree Construction** (🌲)

Select sequences or a sequence list (figure 20.1):

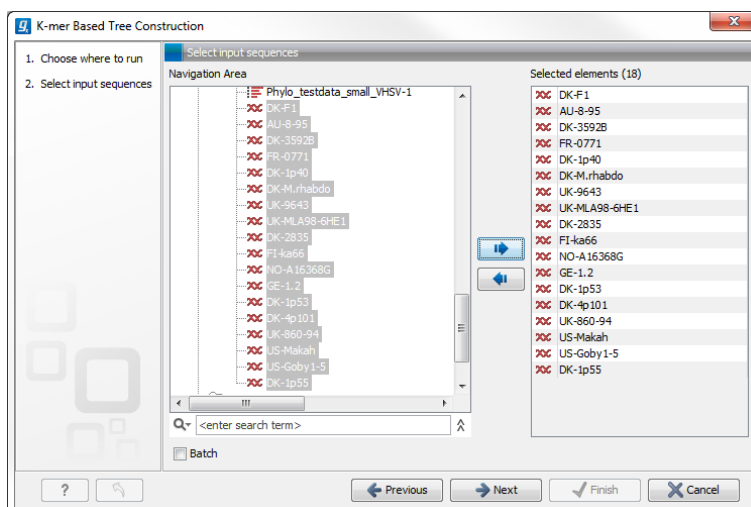

Figure 20.1: Creating a tree with K-mer based tree construction. Select sequences.

Next, select the construction method, specify the k-mer length and select a distance measure for tree construction (figure 20.2):

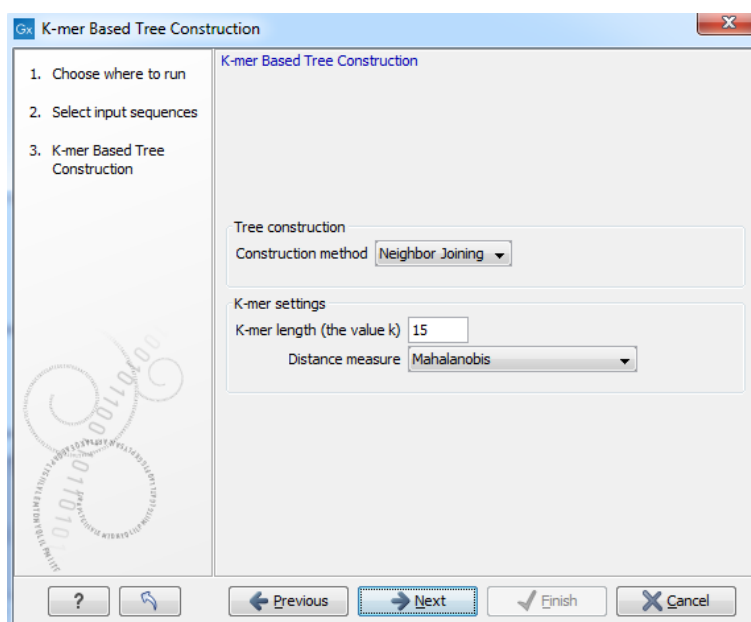

Figure 20.2: Creating a tree with K-mer based tree construction. Select construction method, specify the k-mer length and select a distance measure.

- **Tree construction**

- **Tree construction method** The user is asked to specify which distance-based method to use for tree construction. There are two options (see section 20.2.5):

- * The **UPGMA** method. Assumes constant rate of evolution.
 - * The **Neighbor Joining** method. Well suited for trees with varying rates of evolution.

- **K-mer settings**

- **K-mer length (the value *k*)** Allows specification of the k-mer length, which can be a number between 3 and 50.
- **Distance measure** The distance measure is used to compute the distances between two counts of k-mers. Three options exist: Euclidian squared, Mahalanobis, and Fractional common K-mer count. See 20.2.5 for further details.

20.2.2 Create tree

The "Create tree" tool can be used to generate a distance-based phylogenetic tree with multiple alignments as input:

Toolbox | Classical Sequence Analysis (🗄️) | Alignments and Trees (📁) | Create Tree (🌳)

This will open the dialog displayed in figure 20.3:

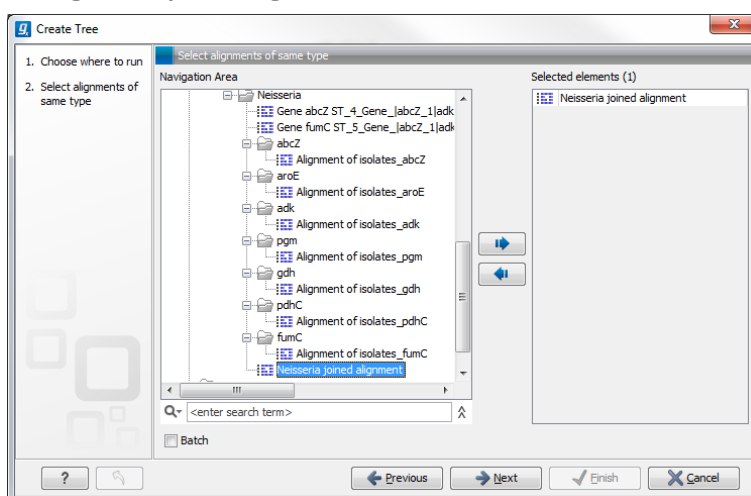

Figure 20.3: Creating a tree.

If an alignment was selected before choosing the Toolbox action, this alignment is now listed in the **Selected Elements** window of the dialog. Use the arrows to add or remove elements from the **Navigation Area**. Click **Next** to adjust parameters.

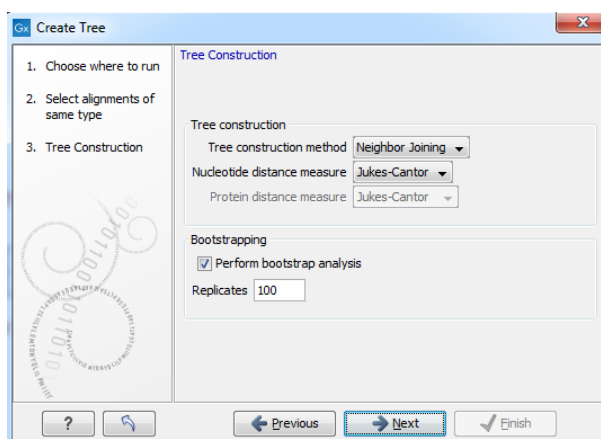

Figure 20.4: Adjusting parameters for distance-based methods.

Figure 20.4 shows the parameters that can be set for this distance-based tree creation:

- Tree construction (see section 20.2.5)
 - Tree construction method
 - * The **UPGMA** method. Assumes constant rate of evolution.
 - * The **Neighbor Joining** method. Well suited for trees with varying rates of evolution.
 - Nucleotide distance measure
 - * **Jukes-Cantor**. Assumes equal base frequencies and equal substitution rates.
 - * **Kimura 80**. Assumes equal base frequencies but distinguishes between transitions and transversions.
 - Protein distance measure
 - * **Jukes-Cantor**. Assumes equal amino acid frequency and equal substitution rates.
 - * **Kimura protein**. Assumes equal amino acid frequency and equal substitution rates. Includes a small correction term in the distance formula that is intended to give better distance estimates than Jukes-Cantor.
- Bootstrapping.
 - Perform bootstrap analysis. To evaluate the reliability of the inferred trees, *CLC Genomics Workbench* allows the option of doing a **bootstrap** analysis (see section 20.2.5). A bootstrap value will be attached to each node, and this value is a measure of the confidence in the subtree rooted at the node. The number of replicates used in the bootstrap analysis can be adjusted in the wizard. The default value is 100 replicates which is usually enough to distinguish between reliable and unreliable nodes in the tree. The bootstrap value assigned to each inner node in the output tree is the percentage (0-100) of replicates which contained the same subtree as the one rooted at the inner node.

For a more detailed explanation, see "Bioinformatics explained" in section 20.2.5.

20.2.3 Model Testing

As the "Model Testing" tool can help identify the best substitution model (20.2.5) to be used for "Maximum Likelihood Phylogeny" tree construction, it is recommended to do "Model Testing" before running the "Maximum Likelihood Phylogeny" tool.

The "Model Testing" tool uses four different statistical analyses:

- Hierarchical likelihood ratio test (hLRT)
- Bayesian information criterion (BIC)
- Minimum theoretical information criterion (AIC)
- Minimum corrected theoretical information criterion (AICc)

to test the substitution models:

- Jukes-Cantor [[Jukes and Cantor, 1969](#)]

- Felsenstein 81 [Felsenstein, 1981]
- Kimura 80 [Kimura, 1980]
- HKY [Hasegawa et al., 1985]
- GTR (also known as the REV model) [Yang, 1994a]

To do model testing:

Toolbox | Classical Sequence Analysis (📁) | Alignments and Trees (📁) | Model Testing (📁)

Select the alignment that you wish to use for the tree construction (figure 20.5):

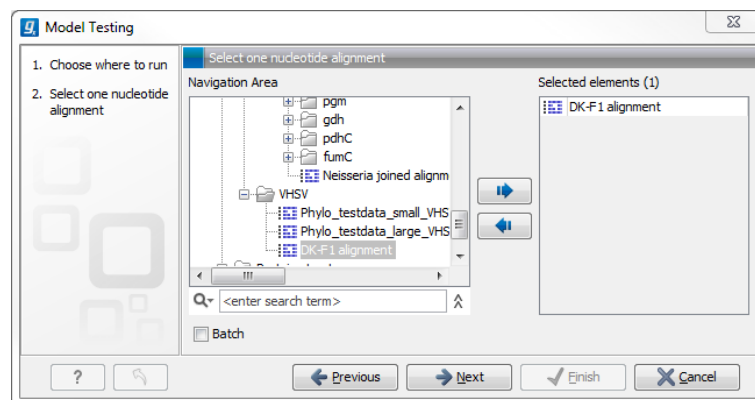

Figure 20.5: Select alignment for model testing.

Specify the parameters to be used for model testing (figure 20.6):

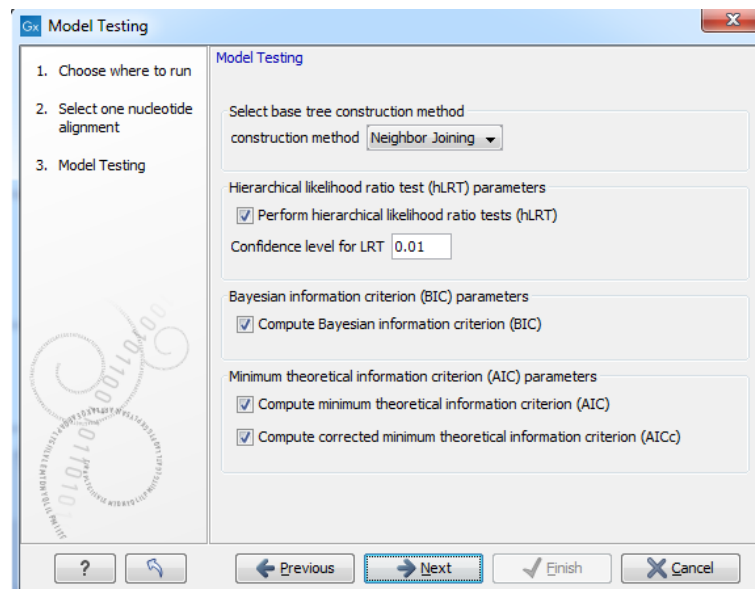

Figure 20.6: Specify parameters for model testing.

- **Select base tree construction method**

A base tree (a guiding tree) is required in order to be able to determine which model(s) would be the most appropriate to use to make the best possible phylogenetic tree from a

specific alignment. The topology of the base tree is used in the hierarchical likelihood ratio test (hLRT), and the base tree is used as starting point for topology exploration in Bayesian information criterion (BIC), Akaike information criterion (or minimum theoretical information criterion) (AIC), and AICc (AIC with a correction for the sample size) ranking.

- **Construction method** A base tree is created automatically using one of two methods from the "Create Tree" tool:
 - * The **UPGMA** method. Assumes constant rate of evolution.
 - * The **Neighbor Joining** method. Well suited for trees with varying rates of evolution.
- **Hierarchical likelihood ratio test (hLRT) parameters** A statistical test of the goodness-of-fit between two models that compares a relatively more complex model to a simpler model to see if it fits a particular dataset significantly better.
 - **Perform hierarchical likelihood ratio test (hLRT)**
 - **Confidence level for LRT** The confidence level used in the likelihood ratio tests.
- **Bayesian information criterion (BIC) parameters**
 - **Compute Bayesian information criterion (BIC)** Rank substitution models based on Bayesian information criterion (BIC). Formula used is $BIC = -2\ln(L) + K\ln(n)$, where $\ln(L)$ is the log-likelihood of the best tree, K is the number of parameters in the model, and $\ln(n)$ is the logarithm of the length of the alignment.
- **Minimum theoretical information criterion (AIC) parameters**
 - **Compute minimum theoretical information criterion (AIC)** Rank substitution models based on minimum theoretical information criterion (AIC). Formula used is $AIC = -2\ln(L) + 2K$, where $\ln(L)$ is the log-likelihood of the best tree, K is the number of parameters in the model.
 - **Compute corrected minimum theoretical information criterion (AICc)** Rank substitution models based on minimum corrected theoretical information criterion (AICc). Formula used is $AICc = -2\ln(L) + 2K + 2K(K+1)/(n-K-1)$, where $\ln(L)$ is the log-likelihood of the best tree, K is the number of parameters in the model, n is the length of the alignment. AICc is recommended over AIC roughly when n/K is less than 40.

The output from model testing is a report that lists all test results in table format. For each tested model the report indicate whether it is recommended to use rate variation or not. Topology variation is recommended in all cases.

From the listed test results, it is up to the user to select the most appropriate model. The different statistical tests will usually agree on which models to recommend although variations may occur. Hence, in order to select the best possible model, it is recommended to select the model that has proven to be the best by most tests.

20.2.4 Maximum Likelihood Phylogeny

To generate a maximum likelihood based phylogenetic tree:

Toolbox | **Classical Sequence Analysis** (📁) | **Alignments and Trees** (📁) | **Maximum Likelihood Phylogeny** (🔧)

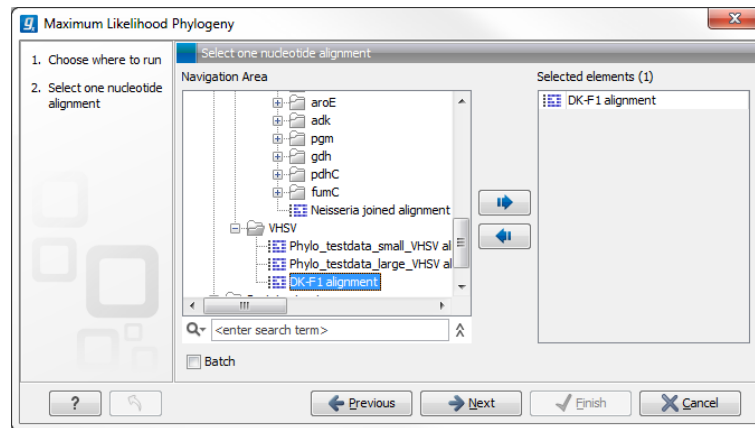

Figure 20.7: Select the alignment for tree construction

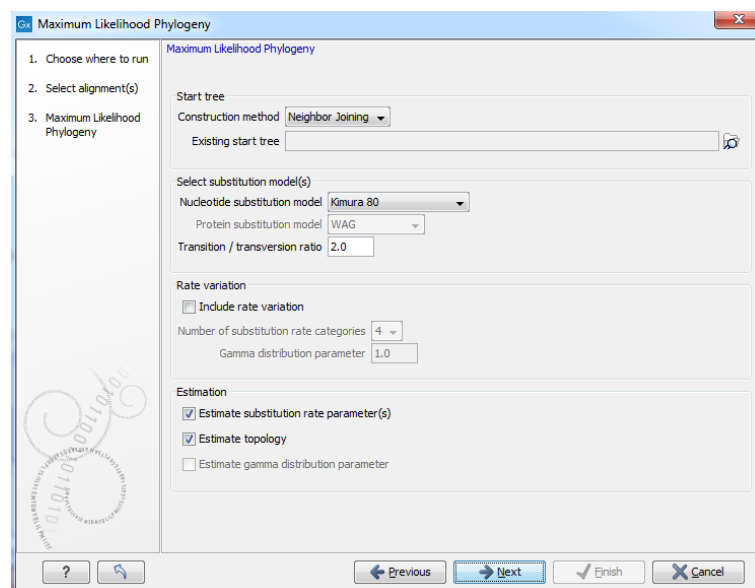

Figure 20.8: Adjusting parameters for maximum likelihood phylogeny

The following parameters can be set for the maximum likelihood based phylogenetic tree (see figure 20.8):

- **Starting tree**

- **Construction method** Specify the tree construction method which should be used to create the initial tree. There are two possibilities:
 - * Neighbor Joining
 - * UPGMA
- **Existing start tree** Alternatively, an existing tree can be used as starting tree for the tree reconstruction. Click on the folder icon to the right of the text field to use the browser function to identify the desired starting tree.

- **Select substitution model**

- **Nucleotide substitution model** *CLC Genomics Workbench* allows maximum likelihood tree estimation to be performed under the assumption of one of five nucleotide substitution models:

- * Jukes-Cantor [Jukes and Cantor, 1969]
- * Felsenstein 81 [Felsenstein, 1981]
- * Kimura 80 [Kimura, 1980]
- * HKY [Hasegawa et al., 1985]
- * General Time Reversible (GTR) (also known as the REV model) [Yang, 1994a]

All models are time-reversible. In the Kimura 80 and HKY models, the user may set a transition/transversion ratio value, which will be used as starting value for optimization or as a fixed value, depending on the level of estimation chosen by the user. For further details, see 20.2.5.

- **Protein substitution model** *CLC Genomics Workbench* allows maximum likelihood tree estimation to be performed under the assumption of one of four protein substitution models:

- * Bishop-Friday [Bishop and Friday, 1985]
- * Dayhoff (PAM) [Dayhoff et al., 1978]
- * JTT [Jones et al., 1992]
- * WAG [Whelan and Goldman, 2001]

The Bishop-Friday substitution model is similar to the Jukes-Cantor model for nucleotide sequences, i.e. it assumes equal amino acid frequencies and substitution rates. This is an unrealistic assumption and we therefore recommend using one of the remaining three models. The Dayhoff, JTT and WAG substitution models are all based on large scale experiments where amino acid frequencies and substitution rates have been estimated by aligning thousands of protein sequences. For these models, the maximum likelihood tool does not estimate parameters, but simply uses those determined from these experiments.

- **Rate variation**

To enable variable substitution rates among individual nucleotide sites in the alignment, select the **include rate variation** box. When selected, the discrete gamma model of Yang [Yang, 1994b] is used to model rate variation among sites. The number of categories used in the discretization of the gamma distribution as well as the gamma distribution parameter may be adjusted by the user (as the gamma distribution is restricted to have mean 1, there is only one parameter in the distribution).

- **Estimation**

Estimation is done according to the maximum likelihood principle, that is, a search is performed for the values of the free parameters in the model assumed that results in the highest likelihood of the observed alignment [Felsenstein, 1981]. By ticking the **estimate substitution rate parameters** box, maximum likelihood values of the free parameters in the rate matrix describing the assumed substitution model are found. If the **Estimate topology** box is selected, a search in the space of tree topologies for that which best explains the alignment is performed. If left un-ticked, the starting topology is kept fixed at that of the starting tree.

The **Estimate Gamma distribution parameter** is active if rate variation has been included in the model and in this case allows estimation of the Gamma distribution

parameter to be switched on or off. If the box is left un-ticked, the value is fixed at that given in the **Rate variation** part. In the absence of rate variation estimation of substitution parameters and branch lengths are carried out according to the expectation maximization algorithm [Dempster et al., 1977]. With rate variation the maximization algorithm is performed. The topology space is searched according to the PHYML method [Guindon and Gascuel, 2003], allowing efficient search and estimation of large phylogenies. **Branch lengths are given in terms of expected numbers of substitutions per nucleotide site.**

In the next step of the wizard it is possible to perform bootstrapping (figure 20.9).

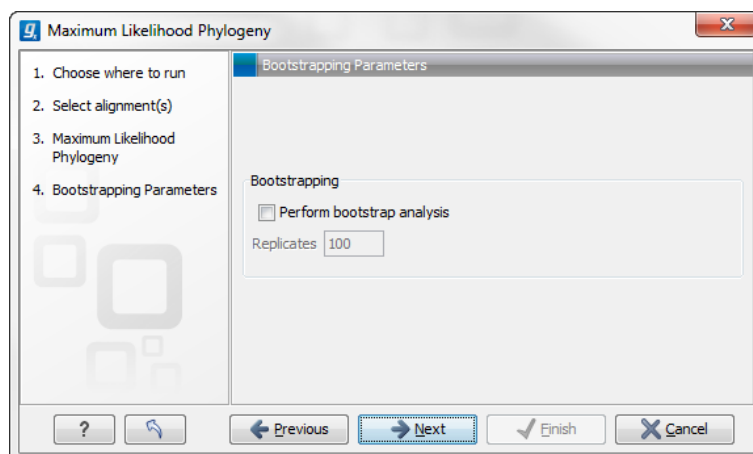

Figure 20.9: Adjusting parameters for ML phylogeny

- **Bootstrapping**

- **Perform bootstrap analysis.** To evaluate the reliability of the inferred trees, *CLC Genomics Workbench* allows the option of doing a **bootstrap** analysis (see section 20.2.5). A bootstrap value will be attached to each node, and this value is a measure of the confidence in the subtree rooted at the node. The number of replicates in the bootstrap analysis can be adjusted in the wizard by specifying the number of times to resample the data. The default value is 100 resamples. The bootstrap value assigned to a node in the output tree is the percentage (0-100) of the bootstrap resamples which resulted in a tree containing the same subtree as that rooted at the node.

20.2.5 Bioinformatics explained

The phylogenetic tree

The evolutionary hypothesis of a phylogeny can be graphically represented by a phylogenetic tree.

Figure 20.10 shows a proposed phylogeny for the great apes, *Hominidae*, taken in part from Purvis [Purvis, 1995]. The tree consists of a number of nodes (also termed vertices) and branches (also termed edges). These nodes can represent either an individual, a species, or a higher grouping and are thus broadly termed taxonomical units. In this case, the terminal nodes (also called leaves or tips of the tree) represent extant species of *Hominidae* and are the *operational taxonomical units* (OTUs). The internal nodes, which here represent extinct common ancestors of the great apes, are termed *hypothetical taxonomical units* since they are not directly observable.

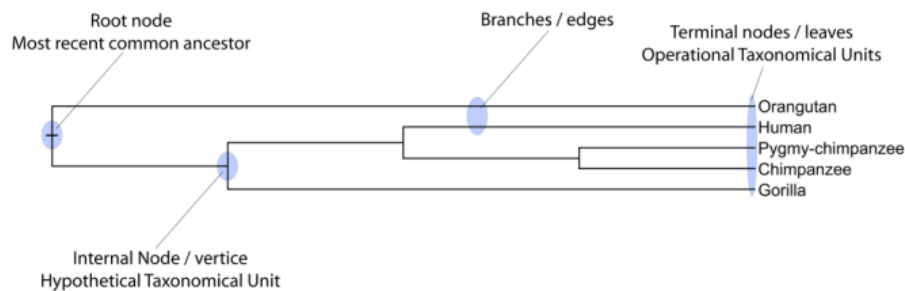

Figure 20.10: A proposed phylogeny of the great apes (*Hominidae*). Different components of the tree are marked, see text for description.

The ordering of the nodes determine the tree *topology* and describes how lineages have diverged over the course of evolution. The branches of the tree represent the amount of evolutionary divergence between two nodes in the tree and can be based on different measurements. A tree is completely specified by its topology and the set of all edge lengths.

The phylogenetic tree in figure 20.10 is rooted at the most recent common ancestor of all *Hominidae* species, and therefore represents a hypothesis of the direction of evolution e.g. that the common ancestor of gorilla, chimpanzee and man existed before the common ancestor of chimpanzee and man. In contrast, an unrooted tree would represent relationships without assumptions about ancestry.

Modern usage of phylogenies

Besides evolutionary biology and systematics the inference of phylogenies is central to other areas of research.

As more and more genetic diversity is being revealed through the completion of multiple genomes, an active area of research within bioinformatics is the development of comparative machine learning algorithms that can simultaneously process data from multiple species [Siepel and Haussler, 2004]. Through the comparative approach, valuable evolutionary information can be obtained about which amino acid substitutions are functionally tolerant to the organism and which are not. This information can be used to identify substitutions that affect protein function and stability, and is of major importance to the study of proteins [Knudsen and Miyamoto, 2001]. Knowledge of the underlying phylogeny is, however, paramount to comparative methods of inference as the phylogeny describes the underlying correlation from shared history that exists between data from different species.

In molecular epidemiology of infectious diseases, phylogenetic inference is also an important tool. The very fast substitution rate of microorganisms, especially the RNA viruses, means that these show substantial genetic divergence over the time-scale of months and years. Therefore, the phylogenetic relationship between the pathogens from individuals in an epidemic can be resolved and contribute valuable epidemiological information about transmission chains and epidemiologically significant events [Leitner and Albert, 1999], [Forsberg et al., 2001].

Substitution models and distance estimation

When estimating the evolutionary distance between organisms, one needs a model of how frequently different mutations occur in the DNA. Such models are known as substitution models.

Our Model Testing and Maximum Likelihood Phylogeny tools currently support the five nucleotide substitution models listed here:

- Jukes-Cantor [[Jukes and Cantor, 1969](#)]
- Felsenstein 81 [[Felsenstein, 1981](#)]
- Kimura 80 [[Kimura, 1980](#)]
- HKY [[Hasegawa et al., 1985](#)]
- GTR (also known as the REV model) [[Yang, 1994a](#)]

Common to all these models is that they assume mutations at different sites in the genome occur independently and that the mutations at each site follow the same common probability distribution. Thus all five models provide relative frequencies for each of the 16 possible DNA substitutions (e.g. $C \rightarrow A$, $C \rightarrow C$, $C \rightarrow G$,...).

The Jukes-Cantor and Kimura 80 models assume equal base frequencies and the HKY and GTR models allow the frequencies of the four bases to differ (they will be estimated by the observed frequencies of the bases in the alignment). In the Jukes-Cantor model all substitutions are assumed to occur at equal rates, in the Kimura 80 and HKY models transition and transversion rates are allowed to differ (substitution between two purines ($A \leftrightarrow G$) or two pyrimidines ($C \leftrightarrow T$) are transitions and purine - pyrimidine substitutions are transversions). The GTR model is the general time reversible model that allows all substitutions to occur at different rates. For the substitution rate matrices describing the substitution models we use the parametrization of Yang [[Yang, 1994a](#)].

For protein sequences, our Maximum Likelihood Phylogeny tool supports four substitution models:

- Bishop-Friday [[Bishop and Friday, 1985](#)]
- Dayhoff (PAM) [[Dayhoff et al., 1978](#)]
- JTT [[Jones et al., 1992](#)]
- WAG [[Whelan and Goldman, 2001](#)]

As with nucleotide substitution models, it is assumed that mutations at different sites in the genome occur independently and according to the same probability distribution.

The Bishop-Friday model assumes all amino acids occur with same frequency and that all substitutions are equally likely. This is the simplest model, but also the most unrealistic. The remaining three models use amino acid frequencies and substitution rates which have been determined from large scale experiments where huge sets of protein sequences have been aligned and rates have been estimated. These three models reflect the outcome of three different experiments. We recommend using WAG as these rates were estimated from the largest experiment.

K-mer based distance estimation

K-mer based distance estimation is an alternative to estimating evolutionary distance based on multiple alignments. At a high level, the distance between two sequences is defined by first collecting the set of k-mers (subsequences of length k) occurring in the two sequences. From these two sets, the evolutionary distance between the two organisms is now defined by measuring how different the two sets are. The more the two sets look alike, the smaller is the evolutionary distance. The main motivation for estimating evolutionary distance based on k-mers, is that it is computationally much faster than first constructing a multiple alignment. Experiments show that phylogenetic tree reconstruction using k-mer based distances can produce results comparable to the slower multiple alignment based methods [Blaisdell, 1989].

All of the k-mer based distance measures completely ignores the ordering of the k-mers inside the input sequences. Hence, if the selected k value (the length of the sequences) is too small, very distantly related organisms may be assigned a small evolutionary distance (in the extreme case where k is 1, two organisms will be treated as being identical if the frequency of each nucleotide/amino-acid is the same in the two corresponding sequences). In the other extreme, the k-mers should have a length (k) that is somewhat below the average distance between mismatches if the input sequences were aligned (in the extreme case of k =the length of the sequences, two organisms have a maximum distance if they are not identical). Thus the selected k value should not be too large and not too small. A general rule of thumb is to only use k-mer based distance estimation for organisms that are not too distantly related.

Formal definition of distance. In the following, we give a more formal definition of the three supported distance measures: Euclidian-squared, Mahalanobis and Fractional common k-mer count. For all three, we first associate a point $p(s)$ to every input sequence s . Each point $p(s)$ has one coordinate for every possible length k sequence (e.g. if s represent nucleotide sequences, then $p(s)$ has 4^k coordinates). The coordinate corresponding to a length k sequence x has the value: "number of times x occurs as a subsequence in s ". Now for two sequences s_1 and s_2 , their evolutionary distance is defined as follows:

- **Euclidian squared:** For this measure, the distance is simply defined as the (squared Euclidian) distance between the two points $p(s_1)$ and $p(s_2)$, i.e.

$$\text{dist}(s_1, s_2) = \sum_i (p(s_1)_i - p(s_2)_i)^2.$$

- **Mahalanobis:** This measure is essentially a fine-tuned version of the Euclidian squared distance measure. Here all the counts $p(s_j)_i$ are "normalized" by dividing with the standard deviation σ_j of the count for the k-mer. The revised formula thus becomes:

$$\text{dist}(s_1, s_2) = \sum_i (p(s_1)_i/\sigma_i - p(s_2)_i/\sigma_i)^2.$$

Here the standard deviations can be computed directly from a set of equilibrium frequencies for the different bases, see [Gentleman and Mullin, 1989].

- **Fractional common k-mer count:** For the last measure, the distance is computed based on the minimum count of every k-mer in the two sequences, thus if two sequences are very different, the minimums will all be small. The formula is as follows:

$$\text{dist}(s_1, s_2) = \log(0.1 + \sum_i (\min(p(s_1)_i, p(s_2)_i) / (\min(n, m) - k + 1))).$$

Here n is the length of s_1 and m is the length of s_2 . This method has been described in [Edgar, 2004].

In experiments performed in [Höhl et al., 2007], the Mahalanobis distance measure seemed to be the best performing of the three supported measures.

Distance based reconstruction methods

Distance based phylogenetic reconstruction methods use a pairwise distance estimate between the input organisms to reconstruct trees. The distances are an estimate of the evolutionary distance between each pair of organisms which are usually computed from DNA or amino acid sequences. Given two homologous sequences a distance estimate can be computed by aligning the sequences and then counting the number of positions where the sequences differ. The number of differences is called the observed number of substitutions and is usually an underestimate of the real distance as multiple mutations could have occurred at any position. To correct for these hidden substitutions a substitution model, such as Jukes-Cantor or Kimura 80, can be used to get a more precise distance estimate (see section 20.2.5).

To correct for these hidden substitutions a substitution model, such as Jukes-Cantor or Kimura 80, can be used to get a more precise distance estimate.

Alternatively, k-mer based methods or SNP based methods can be used to get a distance estimate without the use of substitution models.

After distance estimates have been computed, a phylogenetic tree can be reconstructed using a distance based reconstruction method. Most distance based methods perform a bottom up reconstruction using a greedy clustering algorithm. Initially, each input organism is put in its own cluster which corresponds to a leaf node in the resulting tree. Next, pairs of clusters are iteratively joined into higher level clusters, which correspond to connecting two nodes in the tree with a new parent node. When a single node remains, the tree is reconstructed.

The *CLC Genomics Workbench* provides two of the most widely used distance based reconstruction methods:

- The **UPGMA** method [Michener and Sokal, 1957] which assumes a constant rate of evolution (molecular clock hypothesis) in the different lineages. This method reconstruct trees by iteratively joining the two nearest clusters until there is only one cluster left. The result of the UPGMA method is a rooted bifurcating tree annotated with branch lengths.
- The **Neighbor Joining** method [Saitou and Nei, 1987] attempts to reconstruct a minimum evolution tree (a tree where the sum of all branch lengths is minimized). Opposite to the UPGMA method, the neighbor joining method is well suited for trees with varying rates of evolution in different lineages. A tree is reconstructed by iteratively joining clusters which are close to each other but at the same time far from all other clusters. The resulting tree is a bifurcating tree with branch lengths. Since no particular biological hypothesis is made about the placement of the root in this method, the resulting tree is unrooted.

Maximum likelihood reconstruction methods

Maximum likelihood (ML) based reconstruction methods [Felsenstein, 1981] seek to identify the most probable tree given the data available, i.e. maximize $P(\text{tree}|\text{data})$ where the *tree* refers

to a tree topology with branch lengths while *data* is usually a set of sequences. However, it is not possible to compute $P(\text{tree}|\text{data})$ so instead ML based methods have to compute the probability of the data given a tree, i.e. $P(\text{data}|\text{tree})$. The ML tree is then the tree which makes the data most probable. In other words, ML methods search for the tree that gives the highest probability of producing the observed sequences. This is done by searching through the space of all possible trees while computing an ML estimate for each tree. Computing an ML estimate for a tree is time consuming and since the number of tree topologies grows exponentially with the number of leaves in a tree, it is infeasible to explore all possible topologies. Consequently, ML methods must employ search heuristics that quickly converges towards a tree with a likelihood close to the real ML tree.

The likelihood of trees are computed using an explicit model of evolution such as the Jukes-Cantor or Kimura 80 models. Choosing the right model is often important to get a good result. To help users choose the correct model for a data set, the "Model Testing" tool (see section 20.2.3) can be used to test a range of different models for input nucleotide sequences.

Choosing the right model is often important to get a good result and to help users choose the correct model for a data, set the Model Testing tool (see section 20.2.3) can be used to test a range of different models for nucleotide input sequences.

The search heuristics which are commonly used in ML methods requires an initial phylogenetic tree as a starting point for the search. An initial tree which is close to the optimal solution, can reduce the running time of ML methods and improve the chance of finding a tree with a large likelihood. A common way of reconstructing a good initial tree is to use a distance based method such as UPGMA or neighbor-joining to produce a tree based on a multiple alignment.

Bootstrap tests

Bootstrap tests [Felsenstein, 1985] is one of the most common ways to evaluate the reliability of the topology of a phylogenetic tree. In a bootstrap test, trees are evaluated using Efron's resampling technique [Efron, 1982], which samples nucleotides from the original set of sequences as follows:

Given an alignment of n sequences (rows) of length l (columns), we randomly choose l columns in the alignment with replacement and use them to create a new alignment. The new alignment has n rows and l columns just like the original alignment but it may contain duplicate columns and some columns in the original alignment may not be included in the new alignment. From this new alignment we reconstruct the corresponding tree and compare it to the original tree. For each subtree in the original tree we search for the same subtree in the new tree and add a score of one to the node at the root of the subtree if the subtree is present in the new tree. This procedure is repeated a number of times (usually around 100 times). The result is a counter for each interior node of the original tree, which indicate how likely it is to observe the exact same subtree when the input sequences are sampled. A bootstrap value is then computed for each interior node as the percentage of resampled trees that contained the same subtree as that rooted at the node.

Bootstrap values can be seen as a measure of how reliably we can reconstruct a tree, given the sequence data available. If all trees reconstructed from resampled sequence data have very different topologies, then most bootstrap values will be low, which is a strong indication that the topology of the original tree cannot be trusted.

Scale bar

The scale bar unit depends on the distance measure used and the tree construction algorithm used. The trees produced using the Maximum Likelihood Phylogeny tool has a very specific interpretation: A distance of x means that the expected number of substitutions/changes per nucleotide (amino acid for protein sequences) is x . i.e. if the distance between two taxa is 0.01, you expected a change in each nucleotide independently with probability 1 %. For the remaining algorithms, there is not as nice an interpretation. The distance depends on the weight given to different mutations as specified by the distance measure.

20.3 Tree Settings

The Tree Settings Side Panel found in the left side of the view area can be used to adjust the tree layout and to visualize metadata that is associated with the tree nodes . The following section describes the visualization options available from the Tree Settings side panel. Note however that editing legend boxes related to metadata can be done directly from editing the metadata table (see section 20.4).

The preferred tree layout settings (user defined tree settings) can be saved and applied via the top right **Save Tree Settings** (figure 20.11). Settings can either be saved **For This Tree Only** or for all saved phylogenetic trees (**For Tree View in General**). The first option will save the layout of the tree for that tree only and it ensures that the layout is preserved even if it is exported and opened by a different user. The second option stores the layout globally in the Workbench and makes it available to other trees through the **Apply Saved Settings** option.

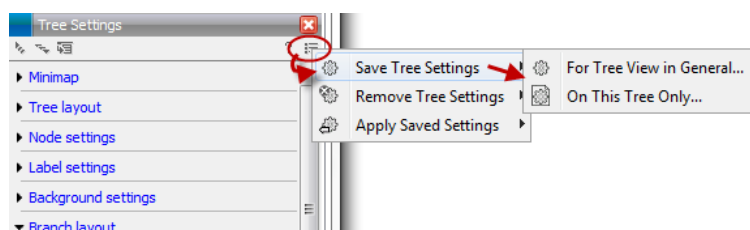

Figure 20.11: Save, remove or apply preferred layout settings.

Tree Settings contains the following categories:

- Minimap
- Tree layout
- Node settings
- Label settings
- Background settings
- Branch layout
- Bootstrap settings
- Metadata

20.3.1 Minimap

The Minimap is a navigation tool that shows a small version of the tree. A grey square indicates the specific part of the tree that is visible in the View Area (figure 20.12). To navigate the tree using the Minimap, click on the Minimap with the mouse and move the grey square around within the Minimap.

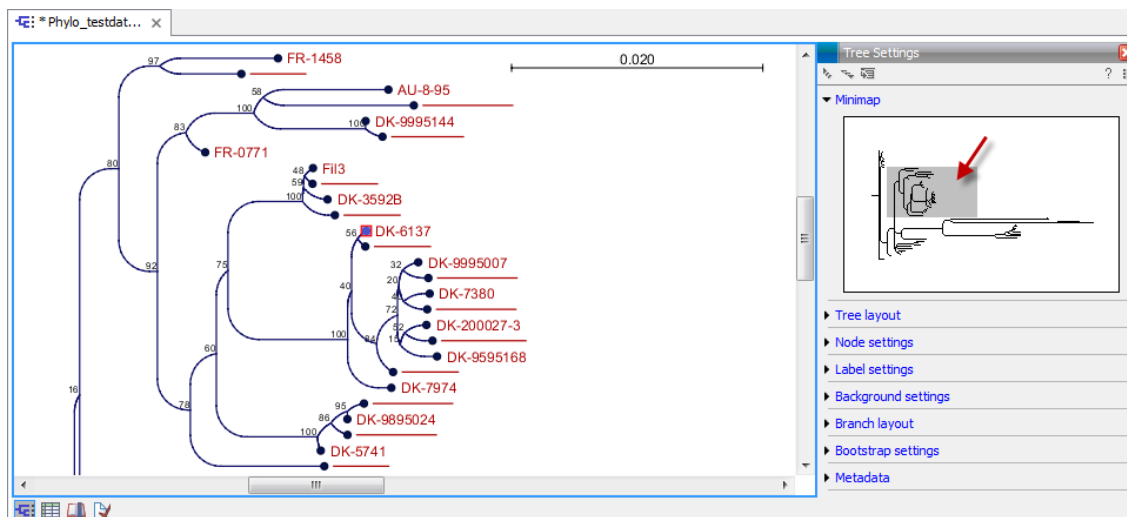

Figure 20.12: Visualization of a phylogenetic tree. The grey square in the Minimap shows the part of the tree that is shown in the View Area.

20.3.2 Tree layout

The **Tree Layout** can be adjusted in the Side Panel (figure 20.13).

- **Layout** Selects one of the five layout types: Phylogram, Cladogram, Circular Phylogram, Circular Cladogram or Radial. Note that only the Cladogram layouts are available if all branches in the tree have zero length.
 - **Phylogram** is a rooted tree where the edges have "lengths", usually proportional to the inferred amount of evolutionary change to have occurred along each branch.
 - **Cladogram** is a rooted tree without branch lengths which is useful for visualizing the topology of trees.
 - **Circular Phylogram** is also a phylogram but with the leaves in a circular layout.
 - **Circular Cladogram** is also a cladogram but with the leaves in a circular layout.
 - **Radial** is an unrooted tree that has the same topology and branch lengths as the rooted styles, but lacks any indication of evolutionary direction.
- **Ordering** The nodes can be ordered after the branch length; either **Increasing** (shown in figure 20.13) or **Decreasing**.
- **Reset Tree Topology** Resets to the default tree topology and node order (see figure 20.13).
- **Fixed width on zoom** Locks the horizontal size of the tree to the size of the main window. Zoom is therefore only performed on the vertical axis when this option is enabled.
- **Show as unrooted tree** The tree can be shown with or without a root.



Figure 20.13: The tree layout can be adjusted in the Side Panel. The top part of the figure shows a tree with increasing node order. In the bottom part of the figure the tree has been reverted to the original tree topology.

20.3.3 Node settings

The nodes can be manipulated in several ways.

- **Leaf node symbol** Leaf nodes can be shown as a range of different symbols (Dot, Box, Circle, etc.).
- **Internal node symbols** The internal nodes can also be shown with a range of different symbols (Dot, Box, Circle, etc.).
- **Max. symbol size** The size of leaf- and internal node symbols can be adjusted.
- **Avoid overlapping symbols** The symbol size will be automatically limited to avoid overlaps between symbols in the current view.
- **Node color** Specify a fixed color for all nodes in the tree.

The node layout settings in the Side Panel are shown in figure 20.14.

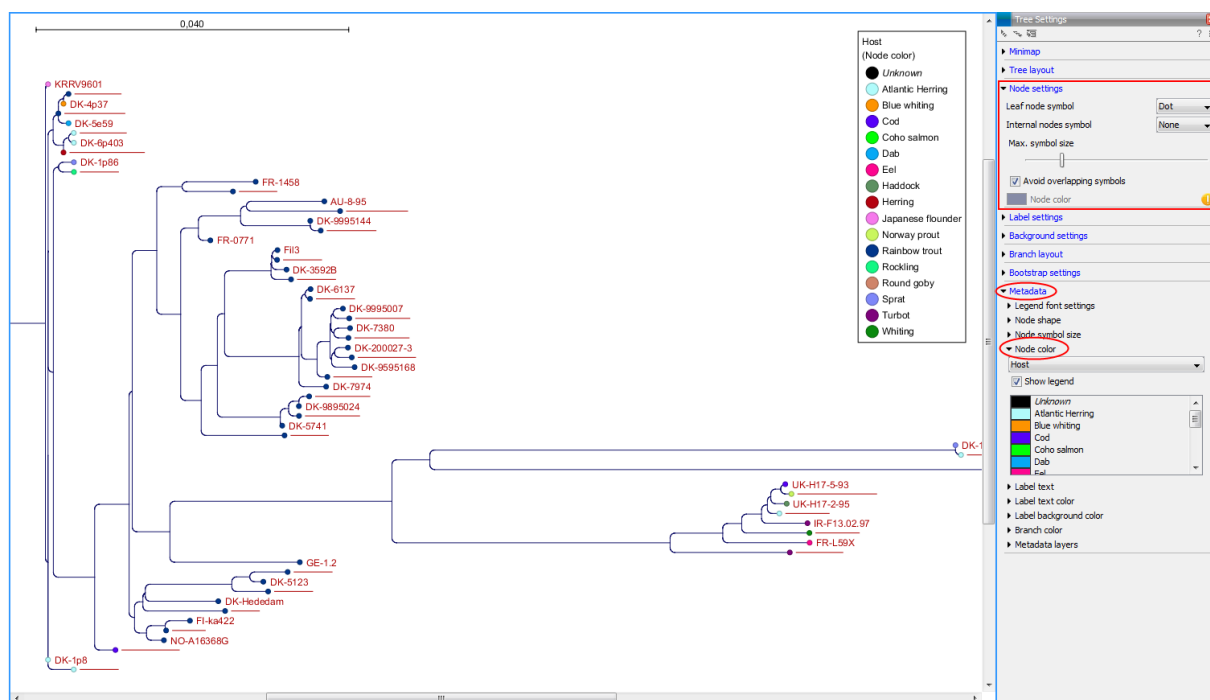

Figure 20.14: The Node Layout settings. Node color is specified by metadata and is therefore inactive in this example.

20.3.4 Label settings

- **Label font settings** Can be used to specify/adjust font type, size and typography (Bold, Italic or normal).
- **Hide overlapping labels** Disable automatic hiding of overlapping labels and display all labels even if they overlap.
- **Show internal node labels** Labels for internal nodes of the tree (if any) can be displayed. Please note that subtrees and nodes can be labeled with a custom text. This is done by right clicking the node and selecting **Edit Label** (see figure 20.15).
- **Show leaf node labels** Leaf node labels can be shown or hidden.
- **Rotate Subtree labels** Subtree labels can be shown horizontally or vertically. Labels are shown vertically when "Rotate subtree labels" has been selected. Subtree labels can be added with the right click option "Set Subtree Label" that is enabled from "Decorate subtree" (see section 20.3.9).
- **Align labels** Align labels to the node furthest from the center of the tree so that all labels are positioned next to each other. The exact behavior depends on the selected tree layout.
- **Connect labels to nodes** Adds a thin line from the leaf node to the aligned label. Only possible when Align labels option is selected.

When working with big trees there is typically not enough space to show all labels. As illustrated in figure 20.15, only some of the labels are shown. The hidden labels are illustrated with thin horizontal lines (figure 20.16).

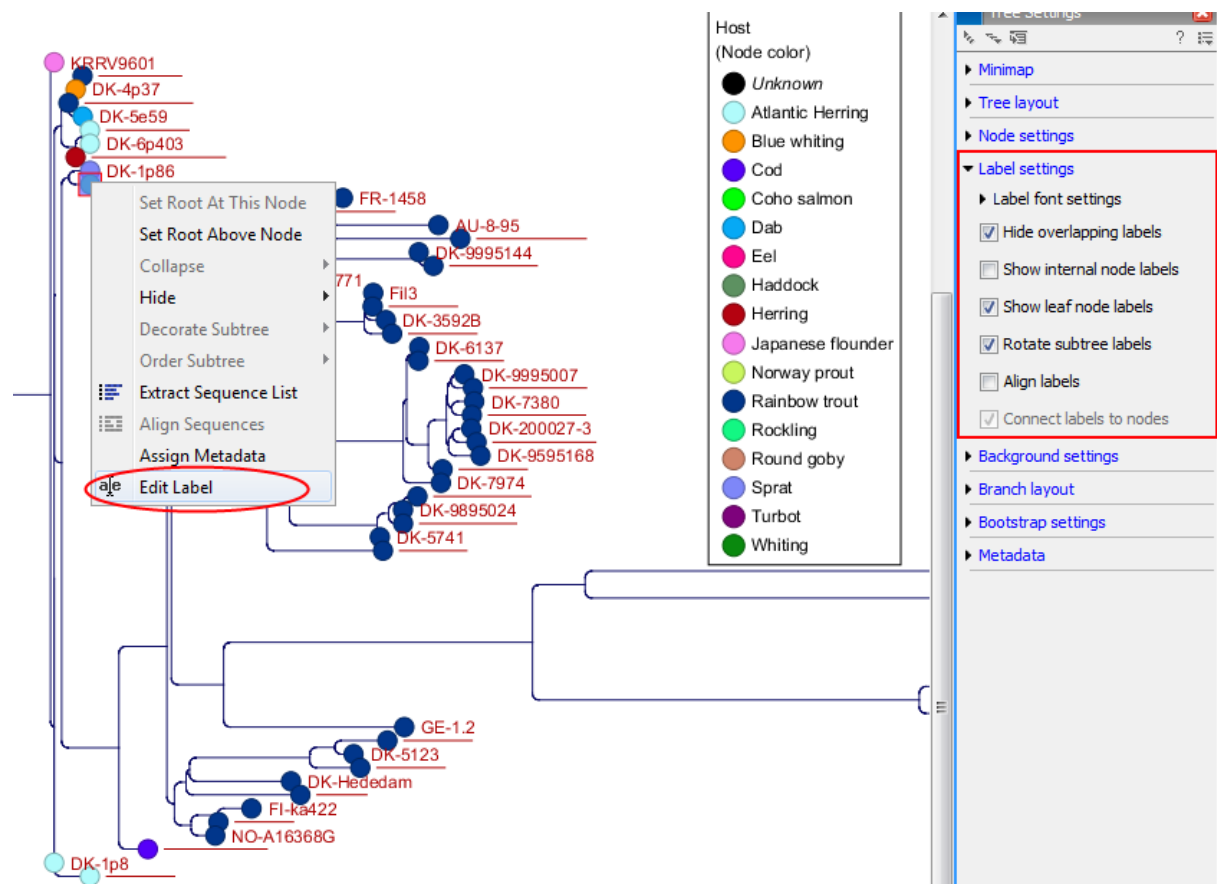

Figure 20.15: "Edit label" in the right click menu can be used to customize the label text. The way node labels are displayed can be controlled through the labels settings in the right side panel.

There are different ways of showing more labels. One way is to reduce the font size of the labels, which can be done under **Label font settings** in the Side Panel. Another option is to zoom in on specific areas of the tree (figure 20.16 and figure 20.17). The last option is to disable **Hide overlapping labels** under "Label settings" in the right side panel. When this option is unchecked all labels are shown even if the text overlaps. When allowing overlapping labels it is usually a good idea to disable **Show label background** under "Background settings" (see section 20.3.5).

Note! When working with a tree with hidden labels, it is possible to make the hidden label text appear by moving the mouse over the node with the hidden label. **Note!** The text within labels can be edited by editing the metadata table values directly.

20.3.5 Background settings

- **Show label background** Show a background color for each label. Once ticked, it is possible to specify whether to use a fixed color or to use the color that is associated with the selected metadata category.

20.3.6 Branch layout

- **Branch length font settings** Specify/adjust font type, size and typography (Bold, Italic or normal).

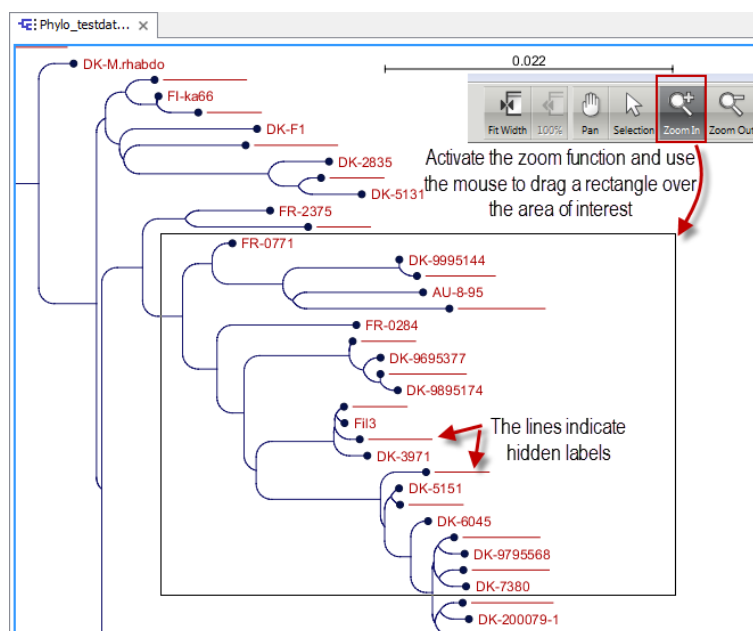

Figure 20.16: The zoom function in the upper right corner of CLC Genomics Workbench can be used to zoom in on a particular region of the tree. When the zoom function has been activated, use the mouse to drag a rectangle over the area that you wish to zoom in at.

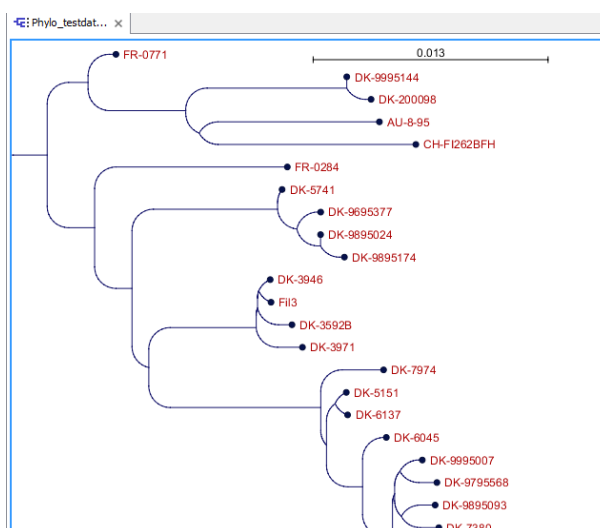

Figure 20.17: After zooming in on a region of interest more labels become visible. In this example all labels are now visible.

- **Line color** Select the default line color.
- **Line width** Select the width of branches (1.0-3.0 pixels).
- **Curvature** Adjust the degree of branch curvature to get branches with round corners.
- **Min. length** Select a minimum branch length. This option can be used to prevent nodes connected with a short branch to cluster at the parent node.
- **Show branch lengths** Show or hide the branch lengths.

The branch layout settings in the Side Panel are shown in figure 20.18.

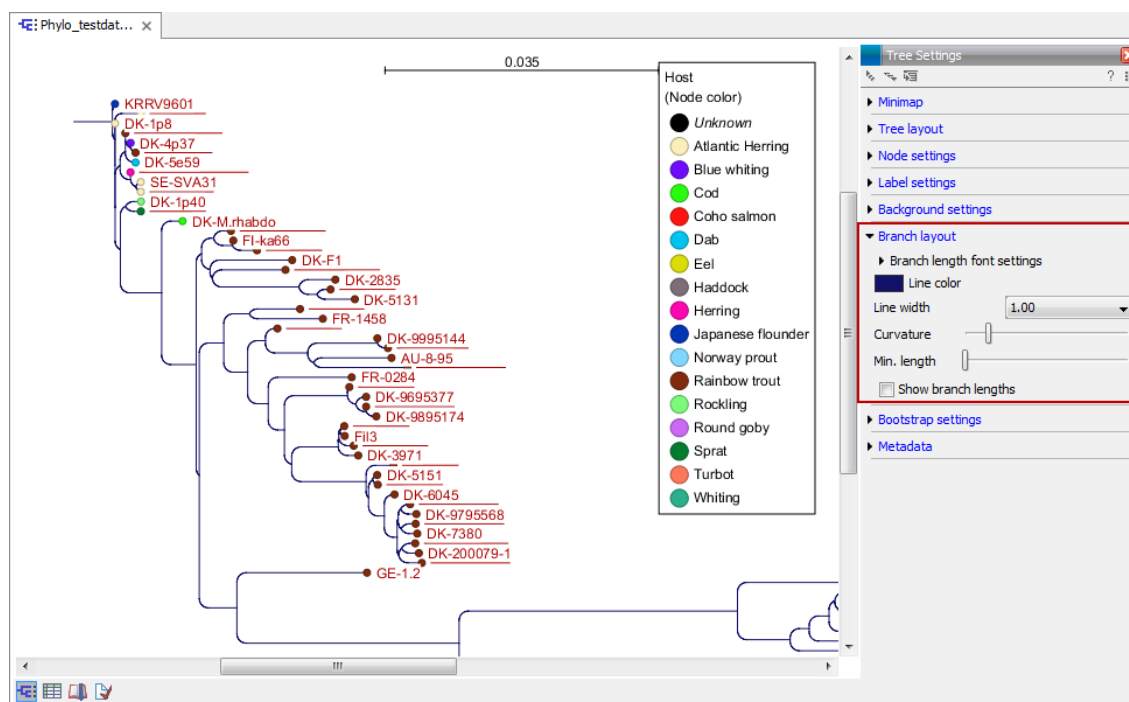

Figure 20.18: Branch Layout settings.

20.3.7 Bootstrap settings

Bootstrap values can be shown on the internal nodes. The bootstrap values are shown in percent and can be interpreted as confidence levels where a bootstrap value close to 100 indicate a clade, which is strongly supported by the data from which the tree was reconstructed. Bootstrap values are useful for identifying clades in the tree where the topology (and branch lengths) should not be trusted.

Some branches in rooted trees may not have bootstrap values. Trees constructed with neighbour joining are unrooted and to correctly visualize them, the "Radial" view is required. In all other tree views we need a root to visualize the tree. An "artificial node" and therefore an extra branch are created for such visualization to achieve this, which makes it look like a bootstrap value is missing

- **Bootstrap value font settings** Specify/adjust font type, size and typography (Bold, Italic or normal).
- **Show bootstrap values (%)** Show or hide bootstrap values. When selected, the bootstrap values (in percent) will be displayed on internal nodes if these have been computed during the reconstruction of the tree.
- **Bootstrap threshold (%)** When specifying a bootstrap threshold, the branch lengths can be controlled manually by collapsing internal nodes with bootstrap values under a certain threshold.
- **Highlight bootstrap \geq (%)** Highlights branches where the bootstrap value is above the user defined threshold.

20.3.8 Visualizing metadata

Metadata associated with a phylogenetic tree (described in detail in section 20.4) can be visualized in a number of different ways:

- **Node shape** Different node shapes are available to visualize metadata.
- **Node symbol size** Change the node symbol size to visualize metadata.
- **Node color** Change the node color to visualize metadata.
- **Label text** The metadata can be shown directly as text labels as shown in figure 20.19.
- **Label text color** The label text can be colored and used to visualize metadata (see figure 20.19).
- **Label background color** The background color of node text labels can be used to visualize metadata.
- **Branch color** Branch colors can be changed according to metadata.
- **Metadata layers** Color coded layers shown next to leaf nodes.

Please note that when visualizing metadata through a tree property that can be adjusted in the right side panel (such as node color or node size), an exclamation mark will appear next to the control for that property to indicate that the setting is inactive because it is defined by metadata (see figure 20.14).

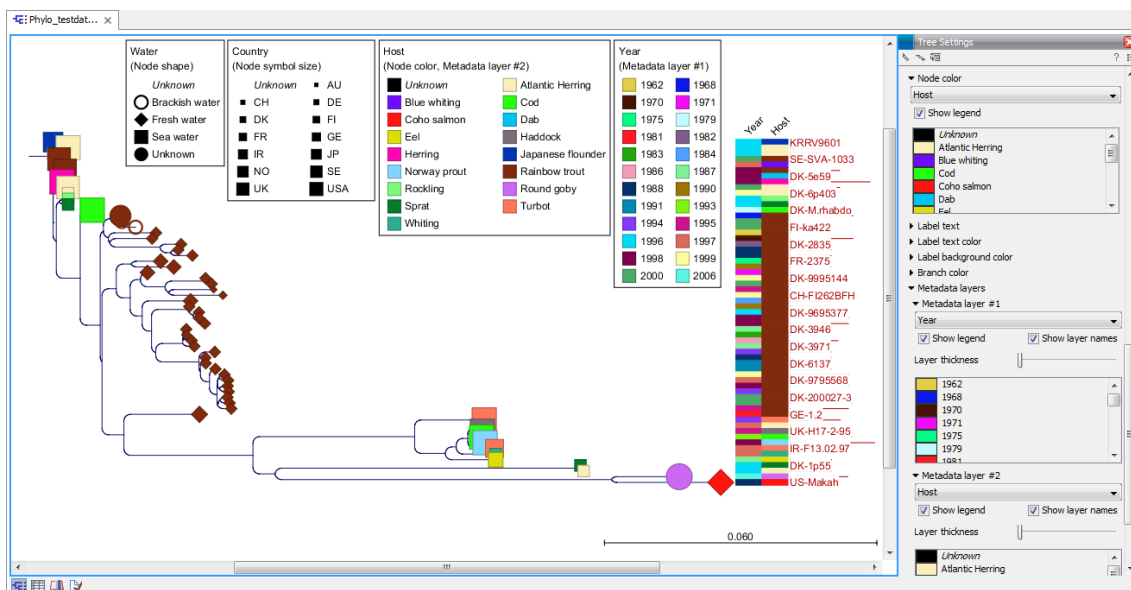

Figure 20.19: Different types of metadata can be visualized by adjusting node size, shape, and color. Two color-code metadata layers (Year and Host) are shown on the right side of the tree.

20.3.9 Node right click menu

Additional options for layout and extraction of subtree data are available when right clicking the nodes (figure 20.15):

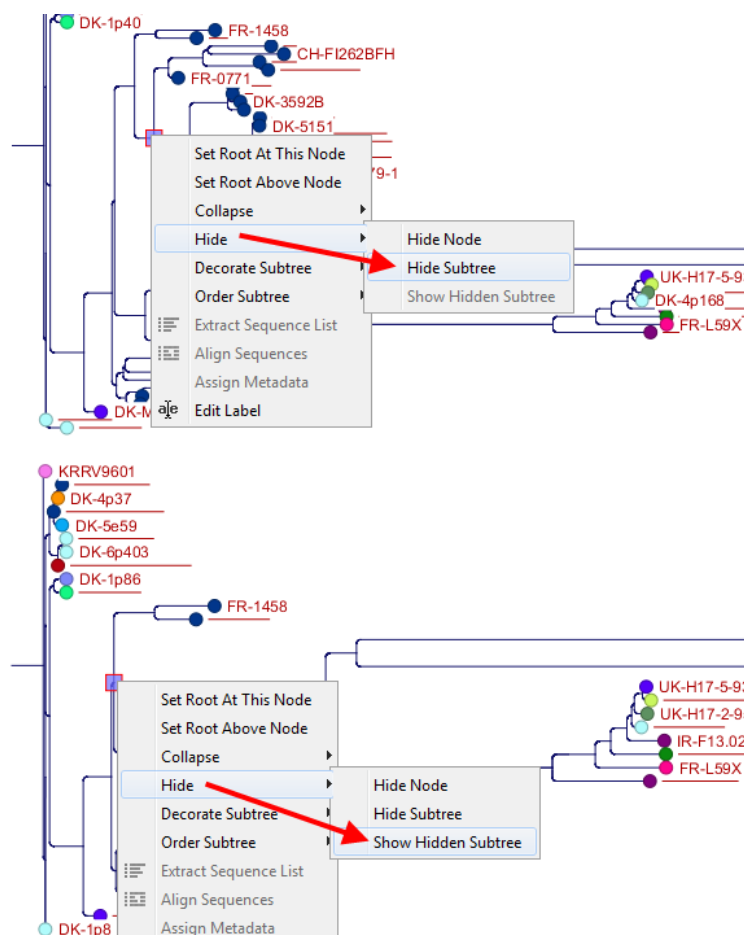

Figure 20.20: A subtree can be hidden by selecting "Hide Subtree" and is shown again when selecting "Show Hidden Subtree" on a parent node.

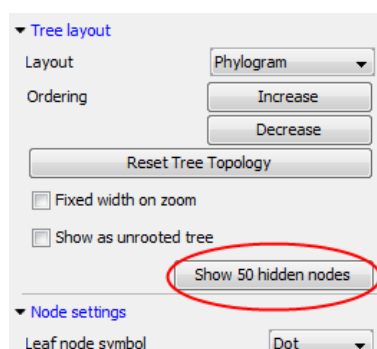

Figure 20.21: When hiding nodes, a new button labeled "Show X hidden nodes" appears in the Side Panel under "Tree Layout". When pressing this button, all hidden nodes are brought back.

- **Set Root At This Node** Re-root the tree using the selected node as root. Please note that re-rooting will change the tree topology.
- **Set Root Above Node** Re-root the tree by inserting a node between the selected node and its parent. Useful for rooting trees using an outgroup.
- **Collapse** Branches associated with a selected node can be collapsed with or without the associated labels. Collapsed branches can be uncollapsed using the *Uncollapse* option in the same menu.

- **Hide** Can be used to hide a node or a subtree. Hidden nodes or subtrees can be shown again using the *Show Hidden Subtree* function on a node which is root in a subtree containing hidden nodes (see figure 20.20). When hiding nodes, a new button appears labeled "Show X hidden nodes" in the Side Panel under "Tree Layout" (figure 20.21). When pressing this button, all hidden nodes are shown again.
- **Decorate Subtree** A subtree can be labeled with a customized name, and the subtree lines and/or background can be colored. To save the decoration, see figure 20.11 and use option: **Save/Restore Settings | Save Tree View Settings On This Tree View only**.
- **Order Subtree** Rearrange leaves and branches in a subtree by Increasing/Decreasing depth, respectively. Alternatively, change the order of a node's children by left clicking and dragging one of the node's children.
- **Extract Sequence List** Sequences associated with selected leaf nodes are extracted to a new sequence list.
- **Align Sequences** Sequences associated with selected leaf nodes are extracted and used as input to the *Create Alignment* tool.
- **Assign Metadata** Metadata can be added, deleted or modified. To add new metadata categories a new "Name" must be assigned. (This will be the column header in the metadata table). To add a new metadata category, enter a value in the "Value" field. To delete values, highlight the relevant nodes and right click on the selected nodes. In the dialog that appears, use the drop-down list to select the name of the desired metadata category and leave the value field empty. When pressing "Add" the values for the selected metadata category will be deleted from the selected nodes. Metadata can be modified in the same way, but instead of leaving the value field empty, the new value should be entered.
- **Edit label** Edit the text in the selected node label. Labels can be shown or hidden by using the Side Panel: **Label settings | Show internal node labels**

20.4 Metadata and phylogenetic trees

When a tree is reconstructed, some mandatory metadata will be added to nodes in the tree. These metadata are special in the sense that the tree viewer has specialized features for visualizing the data and some of them cannot be edited. The mandatory metadata include:

- **Node name** The node name.
- **Branch length** The length of the branch, which connects a node to the parent node.
- **Bootstrap value** The bootstrap value for internal nodes.
- **Size** The length of the sequence which corresponds to each leaf node. This only applies to leaf nodes.
- **Start of sequence** The first 50bp of the sequence corresponding to each leaf node.

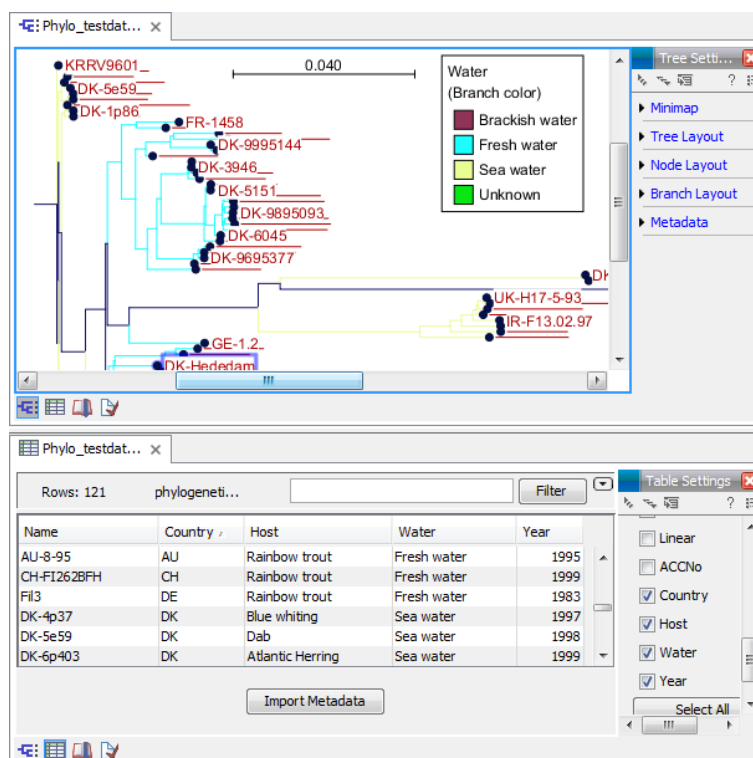

Figure 20.22: Tabular metadata that is associated with an existing tree shown in a split view.

To view metadata associated with a phylogenetic tree, click on the table icon (📄) at the bottom of the tree. If you hold down the Ctrl key (or ⌘ on Mac) while clicking on the table icon (📄), you will be able to see both the tree and the table in a split view (figure 20.22).

Additional metadata can be associated with a tree by clicking the **Import Metadata** button. This will open up the dialog shown in figure 20.23.

To associate metadata with an existing tree a common denominator is required. This is achieved by mapping the node names in the "Name" column of the metadata table to the names that have been used in the metadata table to be imported. In this example the "Strain" column holds the names of the nodes and this column must be assigned "Name" to allow the importer to associate metadata with nodes in the tree.

It is possible to import a subset of the columns in a set of metadata. An example is given in figure 20.23. The column "H" is not relevant to import and can be excluded simply by leaving the text field at the top row of the column empty.

20.4.1 Table Settings and Filtering

How to use the metadata table (see figure 20.24):

- **Column width** The column width can be adjusted in two ways; *Manually* or *Automatically*.
- **Show column** Selects which metadata categories that are shown in the table layout.
- **Filtering Metadata information** Metadata information in a table can be filtered by a simple or advanced mode (this is described in the CLC Genomics Workbench manual, Appendix D, Filtering tables).

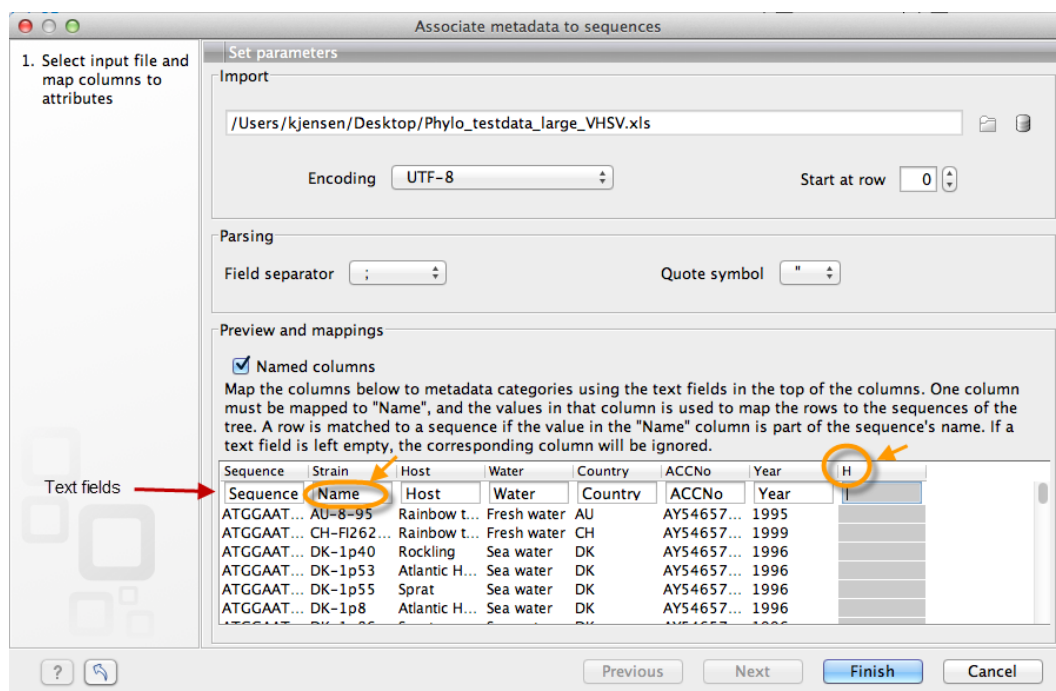

Figure 20.23: Import of metadata for a tree. The second column named "Strain" is chosen as the common denominator by entering "Name" in the text field of the column. The column labeled "H" is ignored by not assigning a column heading to this column.

20.4.2 Add or modify metadata on a tree

It is possible to add and modify metadata from both the tree view and the table view.

Metadata can be added and edited in the metadata table by using the following right click options (see figure 20.25):

- **Assign Metadata** The right click option "Assign Metadata" can be used for four purposes.
 - To add new metadata categories (columns). In this case, a new "Name" must be assigned, which will be the column header. To add a new column requires that a value is entered in the "Value" field. This can be done by right clicking anywhere in the table.
 - To add values to one or more rows in an existing column. In this case, highlight the relevant rows and right click on the selected rows. In the dialog that appears, use the drop-down list to select the name of the desired column and enter a value.
 - To delete values from an existing column. This is done in the same way as when adding a new value, with the only exception that the value field should be left empty.
 - To delete metadata columns. This is done by selecting all rows in the table followed by a right click anywhere in the table. Select the name of the column to delete from the drop down menu and leave the value field blank. When pressing "Add", the selected column will disappear.
- **Delete Metadata "column header"** This is the most simple way of deleting a metadata column. Click on one of the rows in the column to delete and select "Delete column header".

Name	Leaf	Size	ACCNo	Country	Host	Water	Year
KRRV9601	Leaf	1524	AB672614.1	JP	Japanese flounder	Sea water	1996
SE-SVA14	Leaf	1524	AY546622.1	SE	Rainbow trout	Sea water	1998
DK-4p37	Leaf	1524	FJ460590.1	DK	Blue whiting	Sea water	1997
SE-SVA-1033	Leaf	1524	FJ460591.1	SE	Rainbow trout	Sea water	2000
DK-5e59	Leaf	1524	AY546583.1	DK	Dab	Sea water	1998
SE-SVA31	Leaf	1524	AY546626.1	SE	Atlantic Herring	Sea water	2000
DK-6p403	Leaf	1524	AY546584.1	DK	Atlantic Herring	Sea water	1999
UK-MLA98-6HE1	Leaf	1524	AY546631.1	UK	Herring	Sea water	1998
DK-1p86	Leaf	1524	AY546579.1	DK	Sprat	Sea water	1996
DK-1p40	Leaf	1524	AY546575.1	DK	Rockling	Sea water	1996
FR-1458	Leaf	1524	AF143863	FR	Rainbow trout	Fresh water	1990
FR-2375	Leaf	1524	AY546617.1	FR	Rainbow trout	Fresh water	1975
AU-8-95	Leaf	1524	AY546570.1	AU	Rainbow trout	Fresh water	1995
CH-FI2628FH	Leaf	1524	AY546571.1	CH	Rainbow trout	Fresh water	1999
DK-9995144	Leaf	1524	AY546602.1	DK	Rainbow trout	Fresh water	1999
DK-200098	Leaf	1524	AY546605.1	DK	Rainbow trout	Fresh water	2000
FR-0771	Leaf	1524	AY546616.1	FR	Rainbow trout	Fresh water	1971
Fil3	Leaf	1524	Y18263.1	DE	Rainbow trout	Fresh water	1983
DK-3946	Leaf	1524	AY546586.1	DK	Rainbow trout	Fresh water	1987
DK-3592B	Leaf	1524	X66134	DK	Rainbow trout	Fresh water	1986
DK-3971	Leaf	1524	AY546587.1	DK	Rainbow trout	Fresh water	1987
DK-6137	Leaf	1524	AY546593.1	DK	Rainbow trout	Fresh water	1991
DK-5151	Leaf	1524	AF345859.1	DK	Rainbow trout	Fresh water	1988
DK-9995007	Leaf	1524	AY546601.1	DK	Rainbow trout	Fresh water	1999
DK-9795568	Leaf	1524	AY546598.1	DK	Rainbow trout	Fresh water	1997
DK-7380	Leaf	1524	AY546594.1	DK	Rainbow trout	Fresh water	1994
DK-9895093	Leaf	1524	AY546600.1	DK	Rainbow trout	Fresh water	1998
DK-200079-1	Leaf	1524	AY546613.1	DK	Rainbow trout	Fresh water	2000

Figure 20.24: Metadata table. The column width can be adjusted manually or automatically. Under "Show column" it is possible to select which columns should be shown in the table. Filtering using specific criteria can be performed (this is described in the CLC Genomics Workbench manual, Appendix D, Filtering tables).

Water	Country	ACCNo	Year	Host
Unknown	NO	AY546621.1	1968	Rainbow trout
Brackish water			2000	Rainbow trout
Brackish water			2000	Rainbow trout
Fresh water			1962	Rainbow trout
Fresh water			1970	Rainbow trout

Figure 20.25: Right click options in the metadata table.

- **Edit "column header"** To modify existing metadata point, right click on a cell in the table and select the "Edit column header" (see an example in figure 20.26). To edit multiple entries at once, select multiple rows in the table, right click a selected cell in the column you want to edit and choose "Edit column header". This will change values in all selected rows in the column that was clicked.

20.4.3 Undefined metadata values on a tree

When visualizing a metadata category where one or more nodes in the tree have undefined values, these nodes will be visualized using a default value. This value will always be shown in italics in the top of the legend (see the entry "Unknown" in figure 20.27). To remove this entry in the legend, all nodes must have a value assigned in the corresponding metadata category.

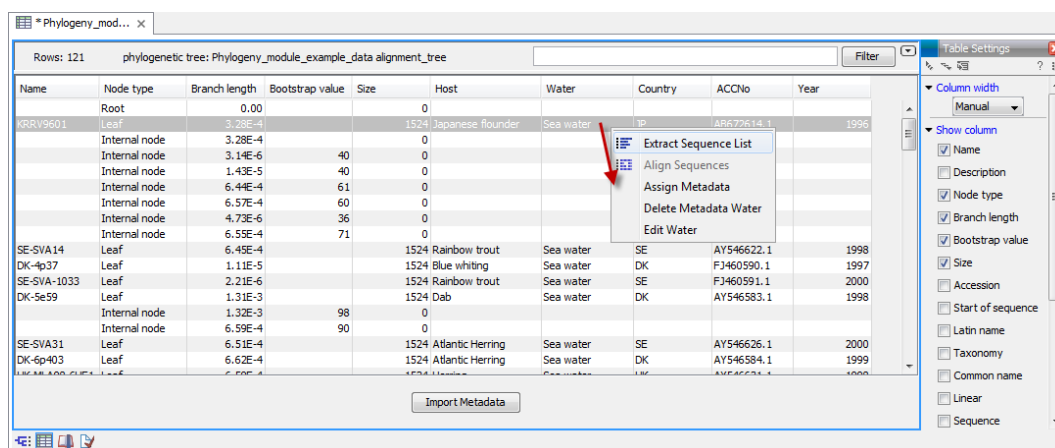

Figure 20.26: To include an extra metadata column, use the right click option "Assign Metadata", provide "Name" (the column header) and "Value". To modify existing metadata, click on the specific field, select "Edit column header" and provide new value.

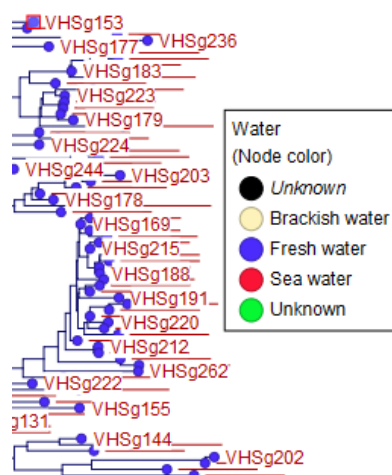

Figure 20.27: A legend for a metadata category where one or more values are undefined. Fill your metadata table with a value of your choice to edit the mention of "unknown" in the legend.

20.4.4 Selection of specific nodes

Selection of nodes in a tree is automatically synchronized to the metadata table and the other way around. Nodes in a tree can be selected in three ways:

- *Selection of a single node* Click once on a single node. Additional nodes can be added by holding down Ctrl (or ⌘ for Mac) and clicking on them (see figure 20.28).
- *Selecting all nodes in a subtree* Double clicking on a inner node results in the selection of all nodes in the subtree rooted at the node.
- *Selection via the Metadata table* Select one or more entries in the table. The corresponding nodes will now be selected in the tree.

It is possible to extract a subset of the underlying sequence data directly through either the tree viewer or the metadata table as follows. Select one or more nodes in the tree where at least one node has a sequence attached. Right click one of the selected nodes and choose **Extract**

Sequence List. This will generate a new sequence list containing all sequences attached to the selected nodes. The same functionality is available in the metadata table where sequences can be extracted from selected rows using the right click menu. Please note that all extracted sequences are copies and any changes to these sequences will not be reflected in the tree.

When analyzing a phylogenetic tree it is often convenient to have a multiple alignment of sequences from e.g. a specific clade in the tree. A quick way to generate such an alignment is to first select one or more nodes in the tree (or the corresponding entries in the metadata table) and then select **Align Sequences** in the right click menu. This will extract the sequences corresponding to the selected elements and use a copy of them as input to the multiple alignment tool (see section 19.6). Next, change relevant option in the multiple alignment wizard that pops up and click **Finish**. The multiple alignment will now be generated.

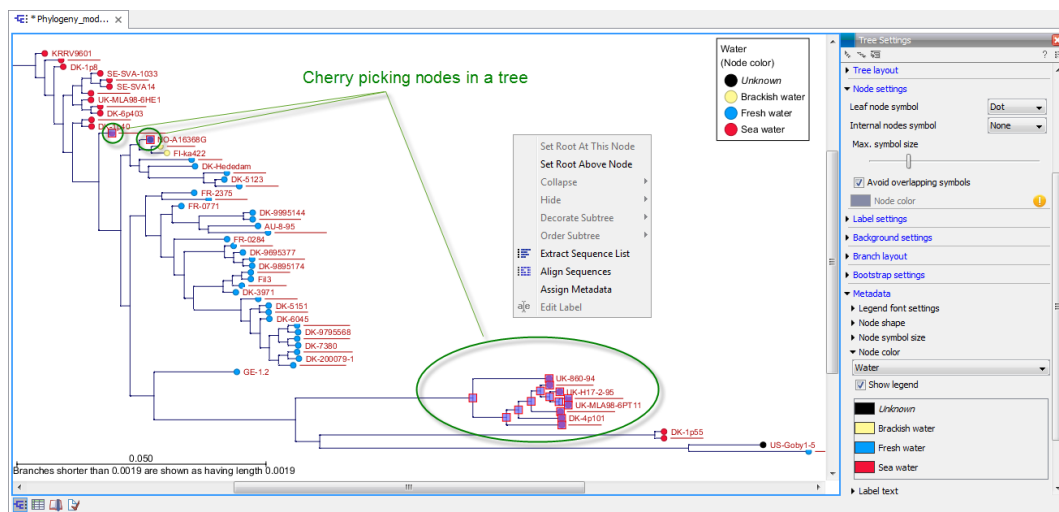

Figure 20.28: Cherry picking nodes in a tree. The selected leaf sequences can be extracted by right clicking on one of the selected nodes and selecting "Extract Sequence List". It is also possible to Align Sequences directly by right clicking on the nodes or leaves.

Chapter 21

RNA structure

Contents

21.1 RNA secondary structure prediction	519
21.1.1 Selecting sequences for prediction	519
21.1.2 Structure output	520
21.1.3 Partition function	521
21.1.4 Advanced options	522
21.1.5 Structure as annotation	524
21.2 View and edit secondary structures	525
21.2.1 Graphical view and editing of secondary structure	525
21.2.2 Tabular view of structures and energy contributions	527
21.2.3 Symbolic representation in sequence view	531
21.2.4 Probability-based coloring	532
21.3 Evaluate structure hypothesis	533
21.3.1 Selecting sequences for evaluation	533
21.3.2 Probabilities	535
21.4 Structure scanning plot	535
21.4.1 Selecting sequences for scanning	535
21.4.2 The structure scanning result	536
21.5 Bioinformatics explained: RNA structure prediction by minimum free energy minimization	537
21.5.1 The algorithm	538
21.5.2 Structure elements and their energy contribution	540

Ribonucleic acid (RNA) is a nucleic acid polymer that plays several important roles in the cell.

As for proteins, the three dimensional shape of an RNA molecule is important for its molecular function. A number of tertiary RNA structures are known from crystallography but de novo prediction of tertiary structures is not possible with current methods. However, as for proteins RNA tertiary structures can be characterized by secondary structural elements which are hydrogen bonds within the molecule that form several recognizable "domains" of secondary structure like stems, hairpin loops, bulges and internal loops. A large part of the functional information is thus

contained in the secondary structure of the RNA molecule, as shown by the high degree of base-pair conservation observed in the evolution of RNA molecules.

Computational prediction of RNA secondary structure is a well defined problem and a large body of work has been done to refine prediction algorithms and to experimentally estimate the relevant biological parameters.

In *CLC Genomics Workbench* we offer the user a number of tools for analyzing and displaying RNA structures. These include:

- Secondary structure prediction using state-of-the-art algorithms and parameters
- Calculation of full partition function to assign probabilities to structural elements and hypotheses
- Scanning of large sequences to find local structure signal
- Inclusion of experimental constraints to the folding process
- Advanced viewing and editing of secondary structures and structure information



21.1 RNA secondary structure prediction

CLC Genomics Workbench uses a minimum free energy (MFE) approach to predict RNA secondary structure. Here, the stability of a given secondary structure is defined by the amount of free energy used (or released) by its formation. The more negative free energy a structure has, the more likely is its formation since more stored energy is released by the event. Free energy contributions are considered additive, so the total free energy of a secondary structure can be calculated by adding the free energies of the individual structural elements. Hence, the task of the prediction algorithm is to find the secondary structure with the minimum free energy. As input to the algorithm empirical energy parameters are used. These parameters summarize the free energy contribution associated with a large number of structural elements. A detailed structure overview can be found in [21.5](#).

In *CLC Genomics Workbench*, structures are predicted by a modified version of Professor Michael Zukers well known algorithm [[Zuker, 1989b](#)] which is the algorithm behind a number of RNA-folding packages including MFOLD. Our algorithm is a dynamic programming algorithm for free energy minimization which includes free energy increments for coaxial stacking of stems when they are either adjacent or separated by a single mismatch. The thermodynamic energy parameters used are from Mfold version 3, see <http://mfold.rna.albany.edu/?q=mfold/mfold-references>.

21.1.1 Selecting sequences for prediction

Secondary structure prediction can be accessed in the **Toolbox**:

Toolbox | **Classical Sequence Analysis**  | **RNA Structure**  | **Predict Secondary Structure** 

This opens the dialog shown in figure [21.1](#).

If you have selected sequences before choosing the Toolbox action, they are now listed in the **Selected Elements** window of the dialog. Use the arrows to add or remove sequences or

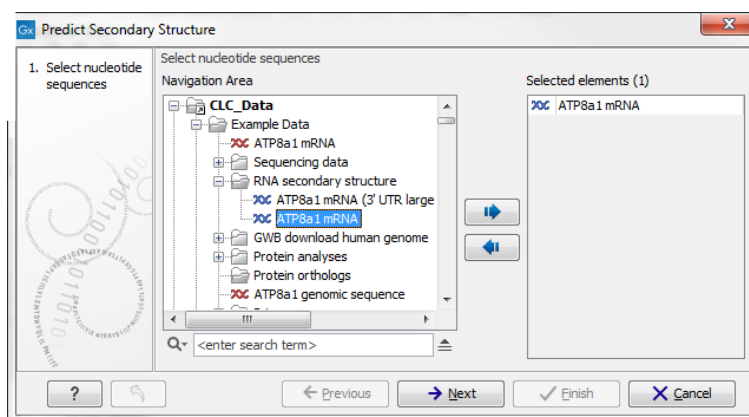

Figure 21.1: Selecting RNA or DNA sequences for structure prediction (DNA is folded as if it was RNA).

sequence lists from the selected elements. You can use both DNA and RNA sequences - DNA will be folded as if it were RNA. Click **Next** to adjust secondary structure prediction parameters. Clicking **Next** opens the dialog shown in figure 21.2.

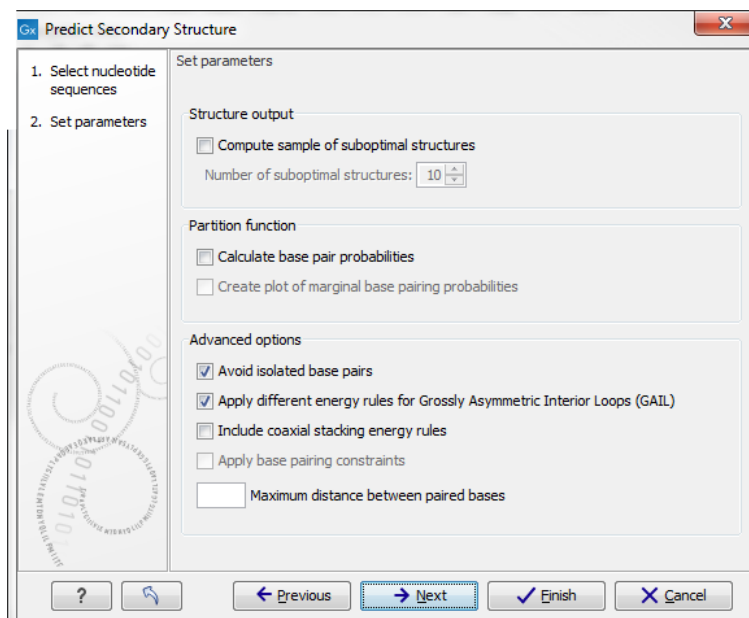

Figure 21.2: Adjusting parameters for secondary structure prediction.

21.1.2 Structure output

The predict secondary structure algorithm always calculates the minimum free energy structure of the input sequence. In addition to this, it is also possible to compute a sample of suboptimal structures by ticking the checkbox labeled **Compute sample of suboptimal structures**. Subsequently, you can specify how many structures to include in the output. The algorithm then iterates over all permissible canonical base pairs and computes the minimum free energy and associated secondary structure constrained to contain a specified base pair. These structures are then sorted by their minimum free energy and the most optimal are reported given the specified number of structures. Note, that two different sub-optimal structures can have the

same minimum free energy. Further information about suboptimal folding can be found in [Zuker, 1989a].

21.1.3 Partition function

The predicted minimum free energy structure gives a point-estimate of the structural conformation of an RNA molecule. However, this procedure implicitly assumes that the secondary structure is at equilibrium, that there is only a single accessible structure conformation, and that the parameters and model of the energy calculation are free of errors.

Obvious deviations from these assumptions make it clear that the predicted MFE structure may deviate somewhat from the actual structure assumed by the molecule. This means that rather than looking at the MFE structure it may be informative to inspect statistical properties of the structural landscape to look for general structural properties which seem to be robust to minor variations in the total free energy of the structure (see [Mathews et al., 2004]).

To this end *CLC Genomics Workbench* allows the user to calculate the complete secondary structure partition function using the algorithm described in [Mathews et al., 2004] which is an extension of the seminal work by [McCaskill, 1990].

There are two options regarding the partition function calculation:

- **Calculate base pair probabilities.** This option invokes the partition function calculation and calculates the marginal probabilities of all possible base pairs and the marginal probability that any single base is unpaired.
- **Create plot of marginal base pairing probabilities.** This creates a plot of the marginal base pair probability of all possible base pairs as shown in figure 21.3.

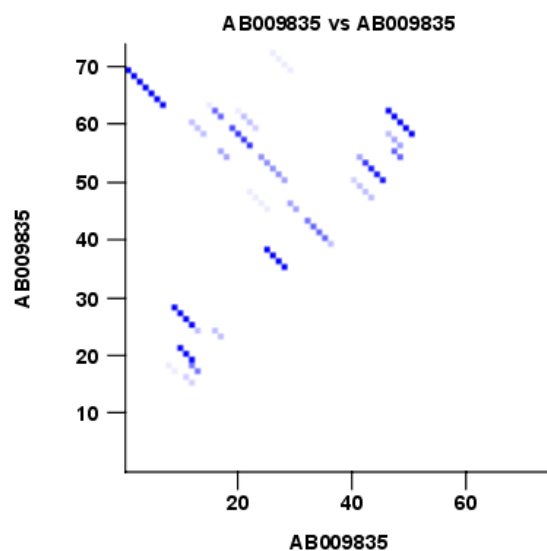

Figure 21.3: *The marginal base pair probability of all possible base pairs.*

The marginal probabilities of base pairs and of bases being unpaired are distinguished by colors which can be displayed in the normal sequence view using the **Side Panel** - see section 21.2.3

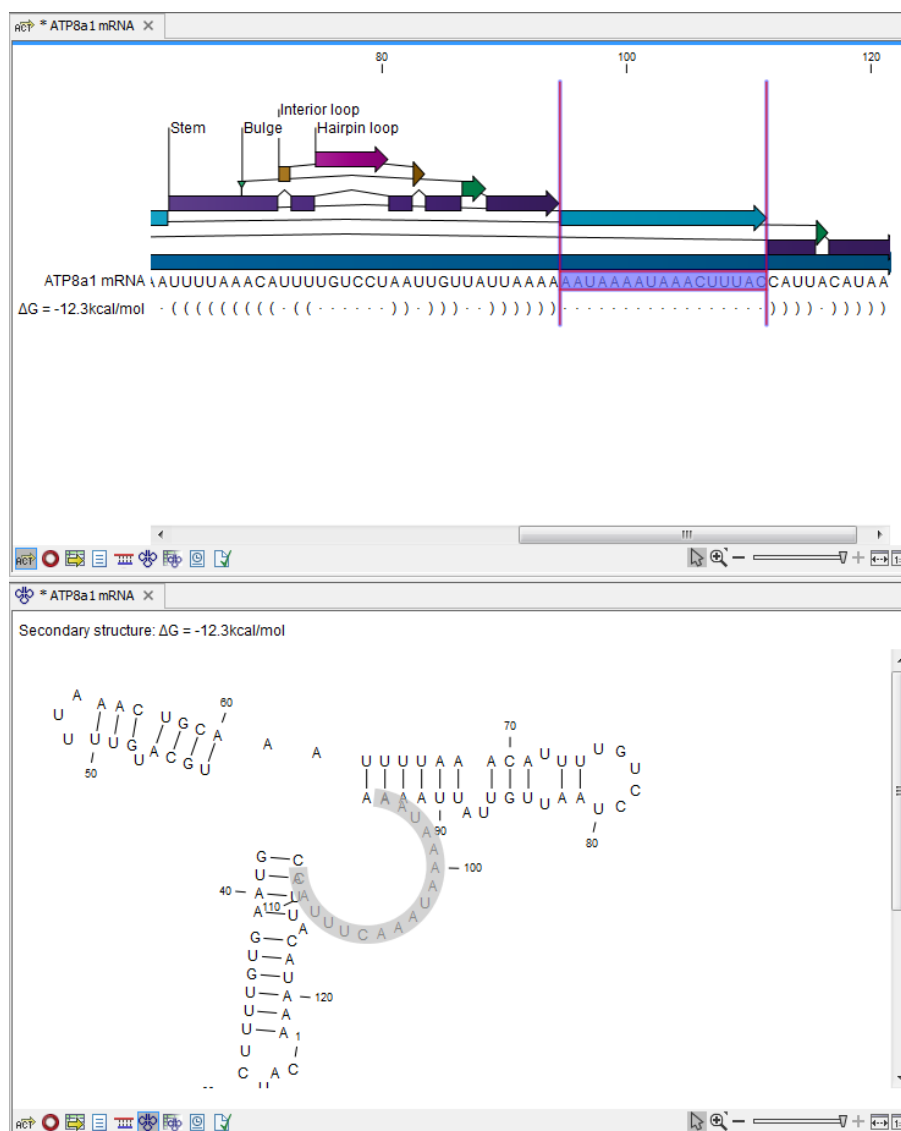

Figure 21.4: Marginal probability of base pairs shown in linear view (top) and marginal probability of being unpaired shown in the secondary structure 2D view (bottom).

and also in the secondary structure view. An example is shown in figure 21.4. Furthermore, the marginal probabilities are accessible from tooltips when hovering over the relevant parts of the structure.

21.1.4 Advanced options

The free energy minimization algorithm includes a number of advanced options:

- **Avoid isolated base pairs.** The algorithm filters out isolated base pairs (i.e. stems of length 1).
- **Apply different energy rules for Grossly Asymmetric Interior Loops (GAIL).** Compute the minimum free energy applying different rules for Grossly Asymmetry Interior Loops (GAIL). A Grossly Asymmetry Interior Loop (GAIL) is an interior loop that is $1 \times n$ or $n \times 1$ where $n > 2$ (see <http://mfold.rna.albany.edu/doc/mfold-manual/node5.php>).

- **Include coaxial stacking energy rules.** Include free energy increments of coaxial stacking for adjacent helices [Mathews et al., 2004].
- **Apply base pairing constraints.** With base pairing constraints, you can easily add experimental constraints to your folding algorithm. When you are computing suboptimal structures, it is not possible to apply base pair constraints. The possible base pairing constraints are:
 - Force two equal length intervals to form a stem.
 - Prohibit two equal length intervals to form a stem.
 - Prohibit all nucleotides in a selected region to be a part of a base pair.

Base pairing constraints have to be added to the sequence before you can use this option - see below.

- **Maximum distance between paired bases.** Forces the algorithms to only consider RNA structures of a given upper length by setting a maximum distance between the base pair that opens a structure.

Specifying structure constraints

Structure constraints can serve two purposes in *CLC Genomics Workbench*: they can act as experimental constraints imposed on the MFE structure prediction algorithm or they can form a structure hypothesis to be evaluated using the partition function (see section 21.1.3).

To *force* two regions to form a stem, open a normal sequence view and:

Select the two regions you want to force by pressing Ctrl while selecting - (use ⌘ on Mac) | right-click the selection | Add Structure Prediction Constraints | Force Stem Here

This will add an annotation labeled "Forced Stem" to the sequence (see figure 21.5).



Figure 21.5: Force a stem of the selected bases.

Using this procedure to add base pairing constraints will force the algorithm to compute minimum free energy and structure with a stem in the selected region. The two regions must be of equal length.

To *prohibit* two regions to form a stem, open the sequence and:

Select the two regions you want to prohibit by pressing Ctrl while selecting - (use ⌘ on Mac) | right-click the selection | Add Structure Prediction Constraints | Prohibit Stem Here

This will add an annotation labeled "Prohibited Stem" to the sequence (see figure 21.6).



Figure 21.6: Prohibit the selected bases from forming a stem.

Using this procedure to add base pairing constraints will force the algorithm to compute minimum free energy and structure without a stem in the selected region. Again, the two selected regions must be of equal length.

To prohibit a region to be part of *any* base pair, open the sequence and:

Select the bases you don't want to base pair | right-click the selection | Add Structure Prediction Constraints | Prohibit From Forming Base Pairs

This will add an annotation labeled "No base pairs" to the sequence, see 21.7.

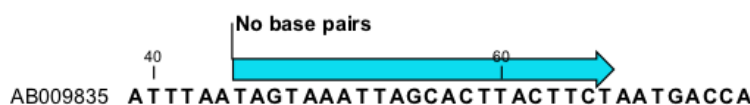

Figure 21.7: Prohibiting any of the selected base from pairing with other bases.

Using this procedure to add base pairing constraints will force the algorithm to compute minimum free energy and structure without a base pair containing any residues in the selected region.

When you click **Predict secondary structure** (⚙️) and click **Next**, check **Apply base pairing constraints** in order to force or prohibit stem regions or prohibit regions from forming base pairs.

You can add multiple base pairing constraints, e.g. simultaneously adding forced stem regions and prohibited stem regions and prohibit regions from forming base pairs.

21.1.5 Structure as annotation

You can choose to add the elements of the best structure as annotations (see figure 21.8).

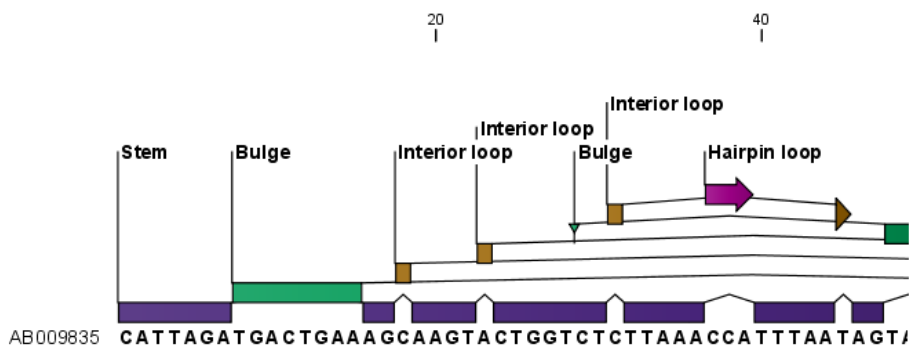

Figure 21.8: Annotations added for each structure element.

This makes it possible to use the structure information in other analysis in the *CLC Genomics Workbench*. You can e.g. align different sequences and compare their structure predictions.

Note that possibly existing structure annotation will be removed when a new structure is calculated and added as annotations.

If you generate multiple structures, only the best structure will be added as annotations. If you wish to add one of the sub-optimal structures as annotations, this can be done from the **Show Secondary Structure Table** (📄) described in section 21.2.2.

21.2 View and edit secondary structures

When you predict RNA secondary structure (see section 21.1), the resulting predictions are attached to the sequence and can be shown as:

- Annotations in the ordinary sequence views (Linear sequence view (📄), Annotation table (📄) etc. This is only possible if this has been chosen in the dialog in figure 21.2. See an example in figure 21.8.
- Symbolic representation below the sequence (see section 21.2.3).
- A graphical view of the secondary structure (see section 21.2.1).
- A tabular view of the energy contributions of the elements in the structure. If more than one structure have been predicted, the table is also used to switch between the structures shown in the graphical view. The table is described in section 21.2.2.

21.2.1 Graphical view and editing of secondary structure

To show the secondary view of an already open sequence, click the **Show Secondary Structure 2D View** (📄) button at the bottom of the sequence view.

If the sequence is not open, click **Show** (📄) and select **Secondary Structure 2D View** (📄).

This will open a view similar to the one shown in figure 21.9.

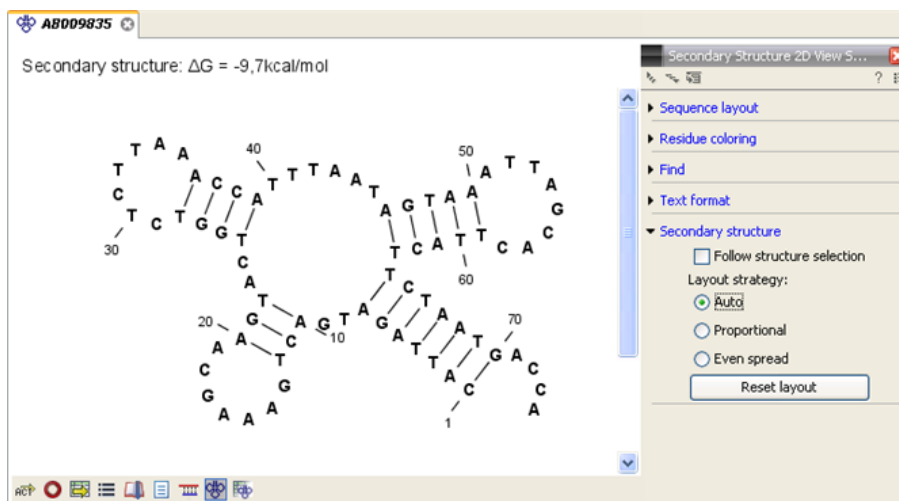

Figure 21.9: The secondary structure view of an RNA sequence zoomed in.

Like the normal sequence view, you can use **Zoom in** (🔍) and **Zoom out** (🔍). Zooming in will reveal the residues of the structure as shown in figure 21.9. For large structures, zooming out will give you an overview of the whole structure.

Side Panel settings

The settings in the **Side Panel** are a subset of the settings in the normal sequence view described in section 10.1.1. However, there are two additional groups of settings unique to the secondary structure 2D view: **Secondary structure**.

- **Follow structure selection.** This setting pertains to the connection between the structures in the secondary structure table (Fig.). If this option is checked, the structure displayed in the secondary structure 2D view will follow the structure selections made in this table. See section 21.2.2 for more information.
- **Layout strategy.** Specify the strategy used for the layout of the structure. In addition to these strategies, you can also modify the layout manually as explained in the next section.
 - **Auto.** The layout is adjusted to minimize overlapping structure elements [Han et al., 1999]. This is the default setting (see figure 21.10).
 - **Proportional.** Arc lengths are proportional to the number of residues (see figure 21.11). Nothing is done to prevent overlap.
 - **Even spread.** Stems are spread evenly around loops as shown in figure 21.12.
- **Reset layout.** If you have manually modified the layout of the structure, clicking this button will reset the structure to the way it was laid out when it was created.

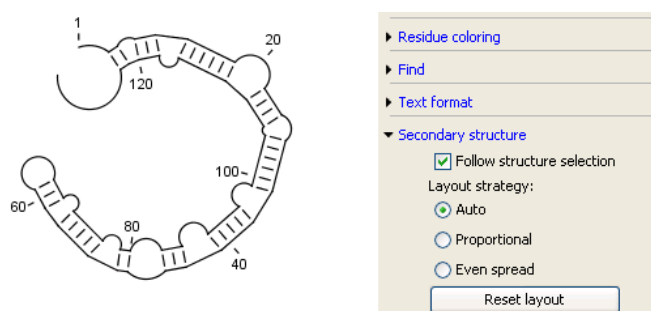

Figure 21.10: Auto layout. Overlaps are minimized.

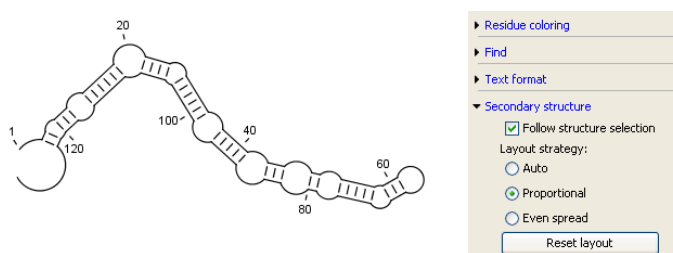

Figure 21.11: Proportional layout. Length of the arc is proportional to the number of residues in the arc.

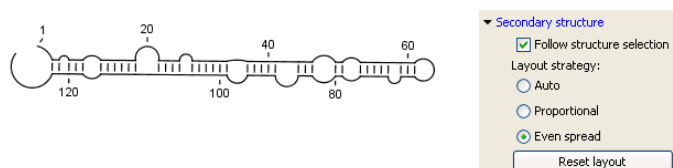



Figure 21.12: Even spread. Stems are spread evenly around loops.

Selecting and editing

When you are in **Selection mode** () , you can select parts of the structure like in a normal sequence view:

Press down the mouse button where the selection should start | move the mouse cursor to where the selection should end | release the mouse button

One of the advantages of the secondary structure 2D view is that it is integrated with other views of the same sequence. This means that any selection made in this view will be reflected in other views (see figure 21.13).

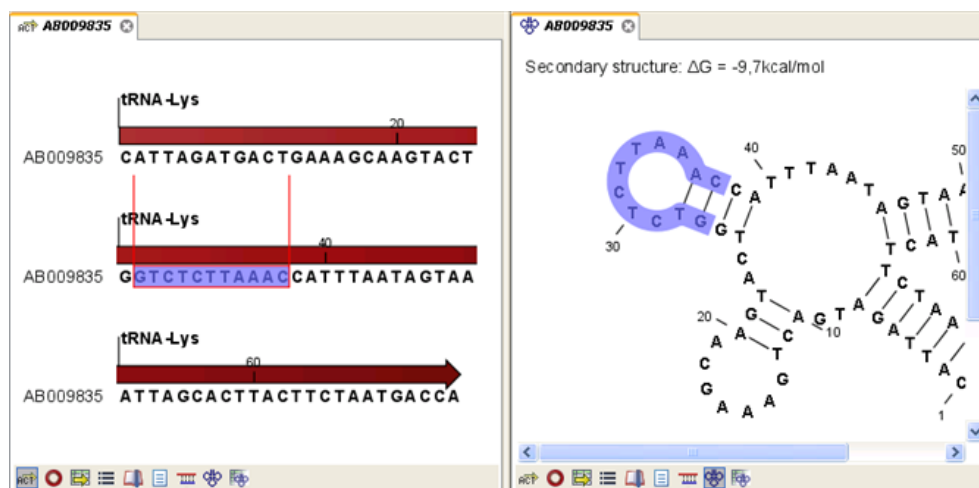



Figure 21.13: A split view of the secondary structure view and a linear sequence view.

If you make a selection in another sequence view, this will also be reflected in the secondary structure view.

The *CLC Genomics Workbench* seeks to produce a layout of the structure where none of the elements overlap. However, it may be desirable to manually edit the layout of a structure for ease of understanding or for the purpose of publication.

To edit a structure, first select the **Pan** () mode in the Tool bar. Now place the mouse cursor on the opening of a stem, and a visual indication of the anchor point for turning the substructure will be shown (see figure 21.14).

Click and drag to rotate the part of the structure represented by the line going from the anchor point. In order to keep the bases in a relatively sequential arrangement, there is a restriction on how much the substructure can be rotated. The highlighted part of the circle represents the angle where rotating is allowed.

In figure 21.15, the structure shown in figure 21.14 has been modified by dragging with the mouse.

Press **Reset layout** in the **Side Panel** to reset the layout to the way it looked when the structure was predicted.

21.2.2 Tabular view of structures and energy contributions

There are three main reasons to use the **Secondary structure table**:

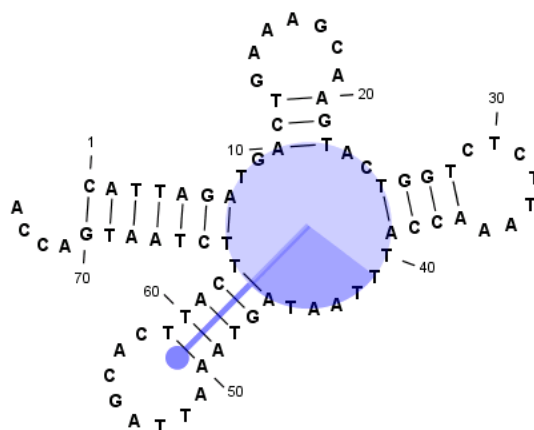

Figure 21.14: The blue circle represents the anchor point for rotating the substructure.

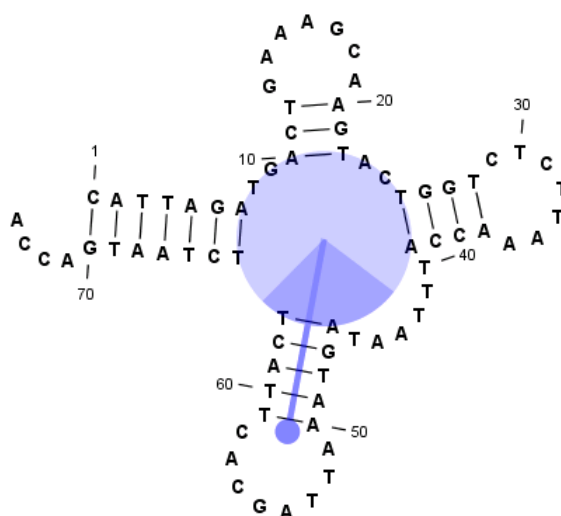

Figure 21.15: The structure has now been rotated.

- If more than one structure is predicted (see section 21.1), the table provides an overview of all the structures which have been predicted.
- With multiple structures you can use the table to determine which structure should be displayed in the Secondary structure 2D view (see section 21.2.1).
- The table contains a hierarchical display of the elements in the structure with detailed information about each element's energy contribution.

To show the secondary structure table of an already open sequence, click the **Show Secondary Structure Table** (📄) button at the bottom of the sequence view.

If the sequence is not open, click **Show** (👉) and select **Secondary Structure Table** (📄).

This will open a view similar to the one shown in figure 21.16.

On the left side, all computed structures are listed with the information about structure name, when the structure was created, the free energy of the structure and the probability of the structure if the partition function was calculated. Selecting a row (equivalent: a structure) will display a tree of the contained substructures with their contributions to the total structure free energy.

The screenshot shows a window titled "ATP8a1 mRNA (...)" with a table of 11 rows. The table has columns for Name, Created, ΔG , and Probability. To the right of the table is a list of substructures for the selected structure, each with a description and its ΔG value.

Name	Created	ΔG	Probability
$\Delta G = -146,7\text{kcal/mol}$	23-Jun-2008 11:48:29	-146,7kcal/mol	6,38E-17
$\Delta G = -146,7\text{kcal/mol}$	23-Jun-2008 11:48:29	-146,7kcal/mol	6,38E-17
$\Delta G = -146,5\text{kcal/mol}$	23-Jun-2008 11:48:29	-146,5kcal/mol	4,61E-17
$\Delta G = -146,5\text{kcal/mol}$	23-Jun-2008 11:48:29	-146,5kcal/mol	4,61E-17
$\Delta G = -146,4\text{kcal/mol}$	23-Jun-2008 11:48:29	-146,4kcal/mol	3,92E-17
$\Delta G = -146,4\text{kcal/mol}$	23-Jun-2008 11:48:29	-146,4kcal/mol	3,92E-17
$\Delta G = -146,4\text{kcal/mol}$	23-Jun-2008 11:48:29	-146,4kcal/mol	3,92E-17
$\Delta G = -146,3\text{kcal/mol}$	23-Jun-2008 11:48:29	-146,3kcal/mol	3,33E-17
$\Delta G = -146,3\text{kcal/mol}$	23-Jun-2008 11:48:29	-146,3kcal/mol	3,33E-17
$\Delta G = -146,3\text{kcal/mol}$	23-Jun-2008 11:48:29	-146,3kcal/mol	3,33E-17
$\Delta G = -146,3\text{kcal/mol}$	23-Jun-2008 11:48:29	-146,3kcal/mol	3,33E-17

Elements of structure: $\Delta G = -146,7\text{kcal/mol}$; $\Delta G = -146,7\text{kcal/mol}$

- Stem with bifurcation at 1..484: $\Delta G = -142,0\text{kcal/mol}$
- U-A helix end at (1, 484): $\Delta G = 0,5\text{kcal/mol}$
- Dangling A at 485, dangling from position 484: $\Delta G = -0,8\text{kcal/mol}$
- Dangling G at 487, dangling from position 488: $\Delta G = -0,2\text{kcal/mol}$
- Stem with hairpin at 488..505: $\Delta G = -2,8\text{kcal/mol}$
- U-A helix end at (488, 505): $\Delta G = 0,5\text{kcal/mol}$
- Dangling A at 506, dangling from position 505: $\Delta G = -0,8\text{kcal/mol}$
- Dangling A at 507, dangling from position 508: $\Delta G = -0,3\text{kcal/mol}$
- Stem with hairpin at 508..539: $\Delta G = -0,5\text{kcal/mol}$
- U-A helix end at (508, 539): $\Delta G = 0,5\text{kcal/mol}$
- Dangling A at 540, dangling from position 539: $\Delta G = -0,8\text{kcal/mol}$

Figure 21.16: The secondary structure table with the list of structures to the left, and to the right the substructures of the selected structure.

Each substructure contains a union of nested structure elements and other substructures (see a detailed description of the different structure elements in section 21.5.2). Each substructure contributes a free energy given by the sum of its nested substructure energies and energies of its nested structure elements.

The substructure elements to the right are ordered after their occurrence in the sequence; they are described by a region (the sequence positions covered by this substructure) and an energy contribution. Three examples of mixed substructure elements are "Stem base pairs", "Stem with bifurcation" and "Stem with hairpin".

The "Stem base pairs"-substructure is simply a union of stacking elements. It is given by a joined set of base pair positions and an energy contribution displaying the sum of all stacking element-energies.

The "Stem with bifurcation"-substructure defines a substructure enclosed by a specified base pair with and with energy contribution ΔG . The substructure contains a "Stem base pairs"-substructure and a nested bifurcated substructure (multi loop). Also bulge and interior loops can occur separating stem regions.

The "Stem with hairpin"-substructure defines a substructure starting at a specified base pair with an enclosed substructure-energy given by ΔG . The substructure contains a "Stem base pairs"-substructure and a hairpin loop. Also bulge and interior loops can occur, separating stem regions.

In order to describe the tree ordering of different substructures, we use an example as a starting point (see figure 21.17).

The structure is a (disjoint) nested union of a "Stem with bifurcation"-substructure and a dangling nucleotide. The nested substructure energies add up to the total energy. The "Stem with bifurcation"-substructure is again a (disjoint) union of a "Stem base pairs"-substructure joining position 1-7 with 64-70 and a multi loop structure element opened at base pair(7,64). To see these structure elements, simply expand the "Stem with bifurcation" node (see figure 21.18).

The multi loop structure element is a union of three "Stem with hairpin"-substructures and contributions to the multi loop opening considering multi loop base pairs and multi loop arcs.

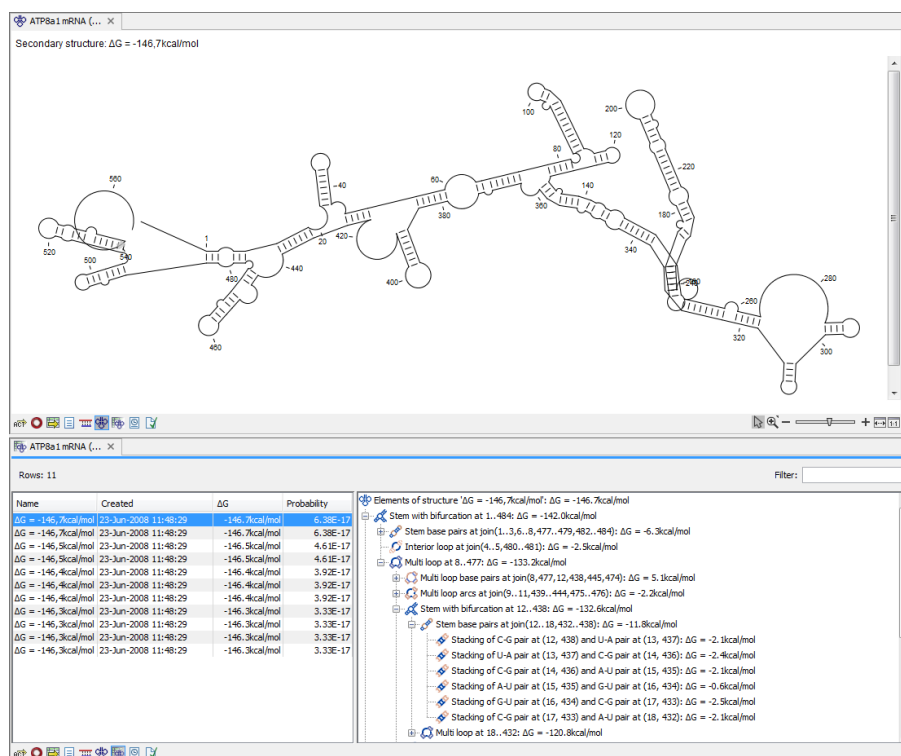

Figure 21.17: A split view showing a structure table to the right and the secondary structure 2D view to the left.

Selecting an element in the table to the right will make a corresponding selection in the **Show Secondary Structure 2D View** (🔗) if this is also open and if the "Follow structure selection" has been set in the editor's side panel. In figure 21.18 the "Stem with bifurcation" is selected in the table, and this part of the structure is high-lighted in the Secondary Structure 2D view.

The correspondence between the table and the structure editor makes it easy to inspect the thermodynamic details of the structure while keeping a visual overview as shown in the above figures.

Handling multiple structures

The table to the left offers a number of tools for working with structures. Select a structure, right-click, and the following menu items will be available:

- **Open Secondary Structure in 2D View** (🔗). This will open the selected structure in the Secondary structure 2D view.
- **Annotate Sequence with Secondary Structure**. This will add the structure elements as annotations to the sequence. Note that existing structure annotations will be removed.
- **Rename Secondary Structure**. This will allow you to specify a name for the structure to be displayed in the table.
- **Delete Secondary Structure**. This will delete the selected structure.
- **Delete All Secondary Structures**. This will delete all the selected structures. Note that once you save and close the view, this operation is irreversible. As long as the view is

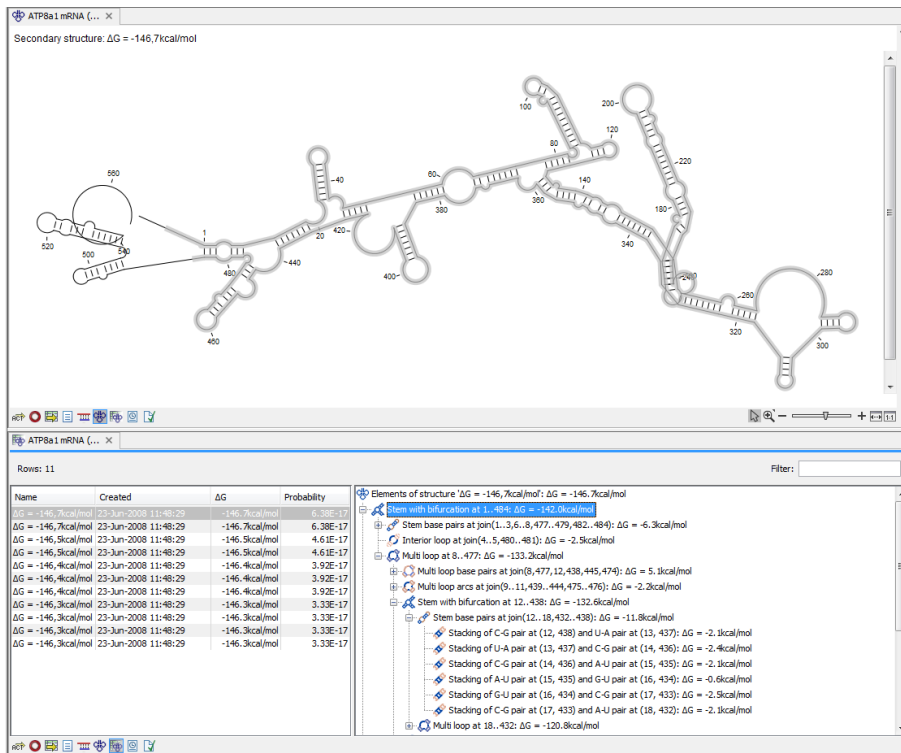

Figure 21.18: Now the "Stem with bifurcation" node has been selected in the table and a corresponding selection has been made in the view of the secondary structure to the left.

open, you can **Undo** (↶) the operation.

21.2.3 Symbolic representation in sequence view

In the **Side Panel** of normal sequence views (RPT), you will find an extra group under **Nucleotide info** called **Secondary Structure**. This is used to display a symbolic representation of the secondary structure along the sequence (see figure 21.19).

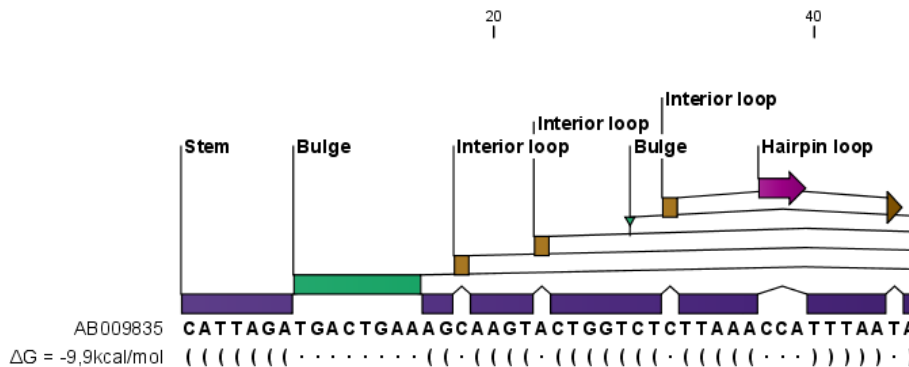

Figure 21.19: The secondary structure visualized below the sequence and with annotations shown above.

The following options can be set:

- **Show all structures.** If more than one structure is predicted, this option can be used if all the structures should be displayed.
- **Show first.** If not all structures are shown, this can be used to determine the number of structures to be shown.
- **Sort by.** When you select to display e.g. four out of eight structures, this option determines which the "first four" should be.
 - Sort by ΔG .
 - Sort by name.
 - Sort by time of creation.

If these three options do not provide enough control, you can rename the structures in a meaningful alphabetical way so that you can use the "name" to display the desired ones.

- **Base pair symbol.** How a base pair should be represented (see figure 21.19).
- **Unpaired symbol.** How bases which are not part of a base pair should be represented (see figure 21.19).
- **Height.** When you zoom out, this option determines the height of the symbols as shown in figure 21.20 (when zoomed in, there is no need for specifying the height).
- **Base pair probability.** See section 21.2.4 below).

When you zoom in and out, the appearance of the symbols change. In figure 21.19, the view is zoomed in. In figure 21.20 you see the same sequence zoomed out to fit the width of the sequence.

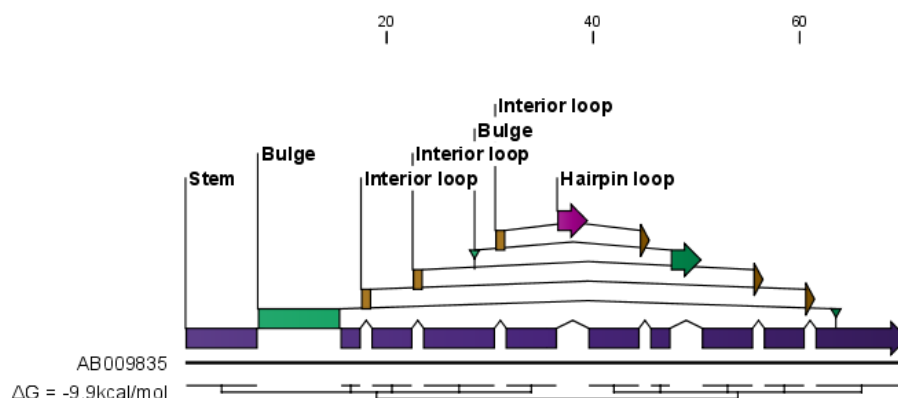

Figure 21.20: The secondary structure visualized below the sequence and with annotations shown above. The view is zoomed out to fit the width of the sequence.

21.2.4 Probability-based coloring

In the **Side Panel** of both linear and secondary structure 2D views, you can choose to color structure symbols and sequence residues according to the probability of base pairing / not base pairing, as shown in figure 21.4.

In the linear sequence view (👉), this is found in **Nucleotide info** under **Secondary structure**, and in the secondary structure 2D view (👉), it is found under **Residue coloring**.

For both paired and unpaired bases, you can set the foreground color and the background color to a gradient with the color at the left side indicating a probability of 0, and the color at the right side indicating a probability of 1.

Note that you have to **Zoom to 100%** (🔍) in order to see the coloring.

21.3 Evaluate structure hypothesis

Hypotheses about an RNA structure can be tested using *CLC Genomics Workbench*. A structure hypothesis H is formulated using the structural constraint annotations described in section 21.1.4. By adding several annotations complex structural hypotheses can be formulated (see 21.21).

Given the set S of all possible structures, only a subset of these S_H will comply with the formulated hypotheses. We can now find the probability of H as:

$$P(H) = \frac{\sum_{s_H \in S_H} P(s_H)}{\sum_{s \in S} P(s)} = \frac{PF_H}{PF_{\text{full}}},$$

where PF_H is the partition function calculated for all structures permissible by H (S_H) and PF_{full} is the full partition function. Calculating the probability can thus be done with two passes of the partition function calculation, one with structural constraints, and one without. 21.21.

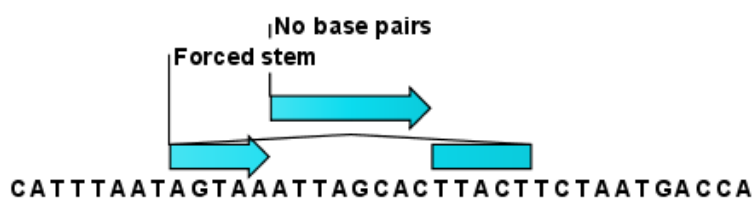

Figure 21.21: Two constraints defining a structural hypothesis.

21.3.1 Selecting sequences for evaluation

The evaluation is started from the **Toolbox**:

Toolbox | **Classical Sequence Analysis** (📁) | **RNA Structure** (📁) | **Evaluate Structure Hypothesis** (👉)

This opens the dialog shown in figure 21.22.

If you have selected sequences before choosing the Toolbox action, they are now listed in the **Selected Elements** window of the dialog. Use the arrows to add or remove sequences or sequence lists from the selected elements. Note, that the selected sequences must contain a structure hypothesis in the form of manually added constraint annotations.

Click **Next** to adjust evaluation parameters (see figure 21.23).

The partition function algorithm includes a number of advanced options:

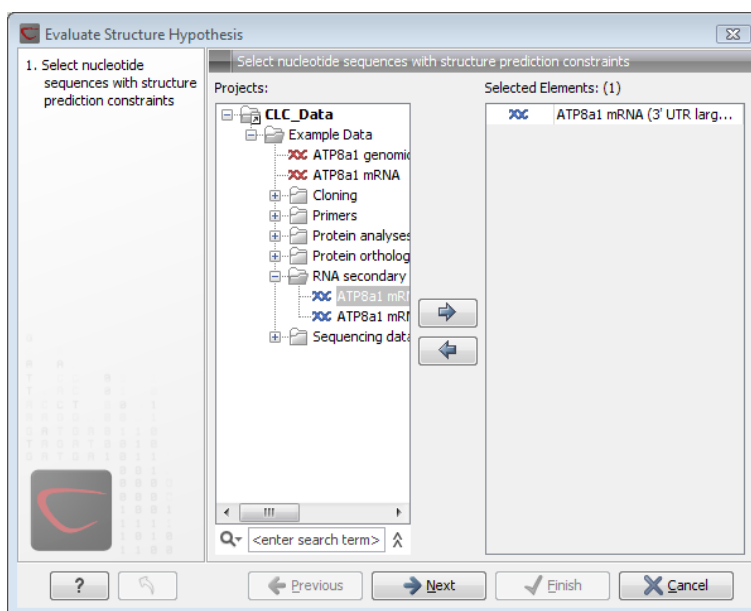

Figure 21.22: Selecting RNA or DNA sequences for evaluating structure hypothesis.

- **Avoid isolated base pairs.** The algorithm filters out isolated base pairs (i.e. stems of length 1).
- **Apply different energy rules for Grossly Asymmetric Interior Loops (GAIL).** Compute the minimum free energy applying different rules for Grossly Asymmetry Interior Loops (GAIL). A Grossly Asymmetry Interior Loop (GAIL) is an interior loop that is $1 \times n$ or $n \times 1$ where $n > 2$ (see <http://mfold.rna.albany.edu/doc/mfold-manual/node5.php>)
- **Include coaxial stacking energy rules.** Include free energy increments of coaxial stacking for adjacent helices [Mathews et al., 2004].

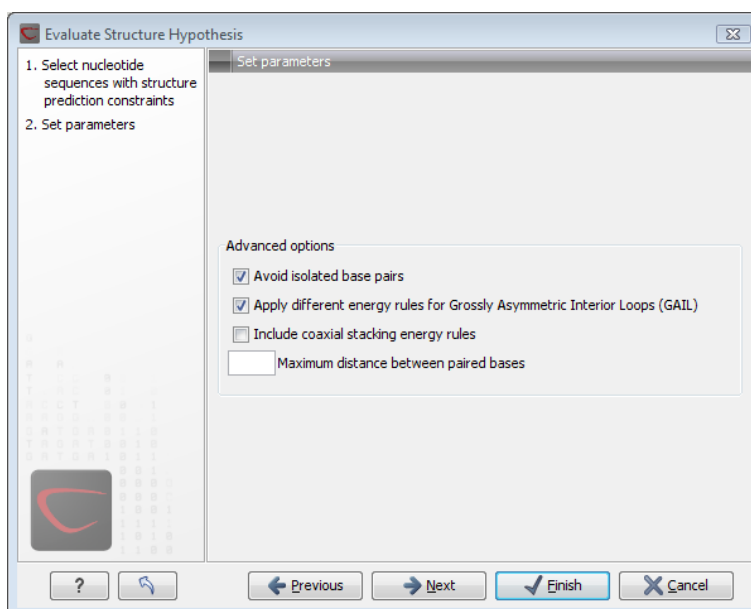

Figure 21.23: Adjusting parameters for hypothesis evaluation.

21.3.2 Probabilities

After evaluation of the structure hypothesis an annotation is added to the input sequence. This annotation covers the same region as the annotations that constituted the hypothesis and contains information about the probability of the evaluated hypothesis (see figure 21.24).

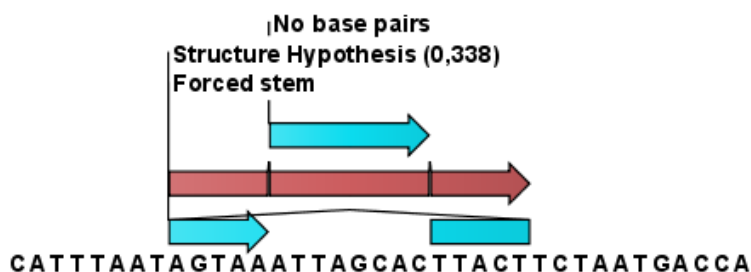

Figure 21.24: This hypothesis has a probability of 0.338 as shown in the annotation.

21.4 Structure scanning plot

In *CLC Genomics Workbench* it is possible to scan larger sequences for the existence of local conserved RNA structures. The structure scanning approach is similar in spirit to the works of [Workman and Krogh, 1999] and [Clote et al., 2005]. The idea is that if natural selection is operating to maintain a stable local structure in a given region, then the minimum free energy of the region will be markedly lower than the minimum free energy found when the nucleotides of the subsequence are distributed in random order.

The algorithm works by sliding a window along the sequence. Within the window, the minimum free energy of the subsequence is calculated. To evaluate the significance of the local structure signal its minimum free energy is compared to a background distribution of minimum free energies obtained from shuffled sequences, using Z -scores [Rivas and Eddy, 2000]. The Z -score statistics corresponds to the number of standard deviations by which the minimum free energy of the original sequence deviates from the average energy of the shuffled sequences. For a given Z -score, the statistical significance is evaluated as the probability of observing a more extreme Z -score under the assumption that Z -scores are normally distributed [Rivas and Eddy, 2000].

21.4.1 Selecting sequences for scanning

The scanning is started from the **Toolbox**:

Toolbox | **Classical Sequence Analysis** (📁) | **RNA Structure** (📁) | **Evaluate Structure Hypothesis** (📄)

This opens the dialog shown in figure 21.25.

If you have selected sequences before choosing the Toolbox action, they are now listed in the **Selected Elements** window of the dialog. Use the arrows to add or remove sequences or sequence lists from the selected elements.

Click **Next** to adjust scanning parameters (see figure 21.26).

The first group of parameters pertain to the methods of sequence resampling. There are four ways of resampling, all described in detail in [Clote et al., 2005]:

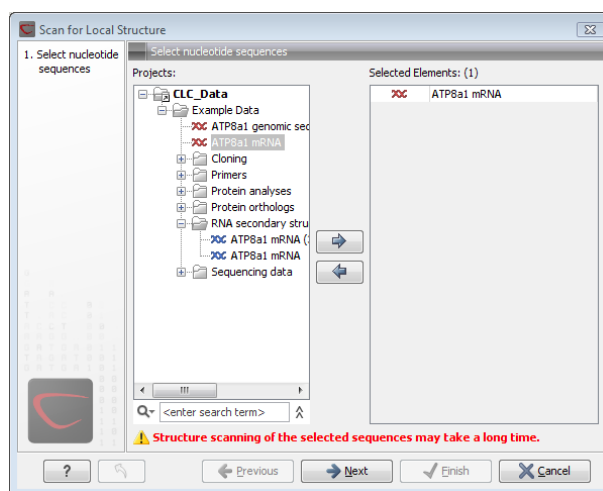

Figure 21.25: Selecting RNA or DNA sequences for structure scanning.

- **Mononucleotide shuffling.** Shuffle method generating a sequence of the exact same mononucleotide frequency
- **Dinucleotide shuffling.** Shuffle method generating a sequence of the exact same dinucleotide frequency
- **Mononucleotide sampling from zero order Markov chain.** Resampling method generating a sequence of the same expected mononucleotide frequency.
- **Dinucleotide sampling from first order Markov chain.** Resampling method generating a sequence of the same expected dinucleotide frequency.

The second group of parameters pertain to the scanning settings and include:

- **Window size.** The width of the sliding window.
- **Number of samples.** The number of times the sequence is resampled to produce the background distribution.
- **Step increment.** Step increment when plotting sequence positions against scoring values.

The third parameter group contains the output options:

- **Z-scores.** Create a plot of Z-scores as a function of sequence position.
- **P-values.** Create a plot of the statistical significance of the structure signal as a function of sequence position.

21.4.2 The structure scanning result

The output of the analysis are plots of Z -scores and probabilities as a function of sequence position. A strong propensity for local structure can be seen as spikes in the graphs (see figure 21.27).

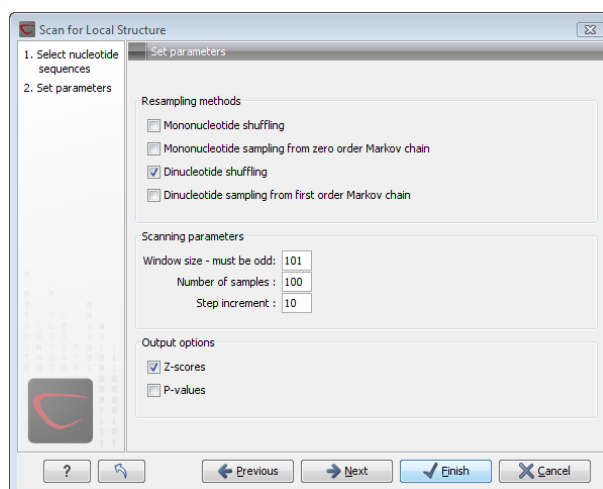

Figure 21.26: Adjusting parameters for structure scanning.

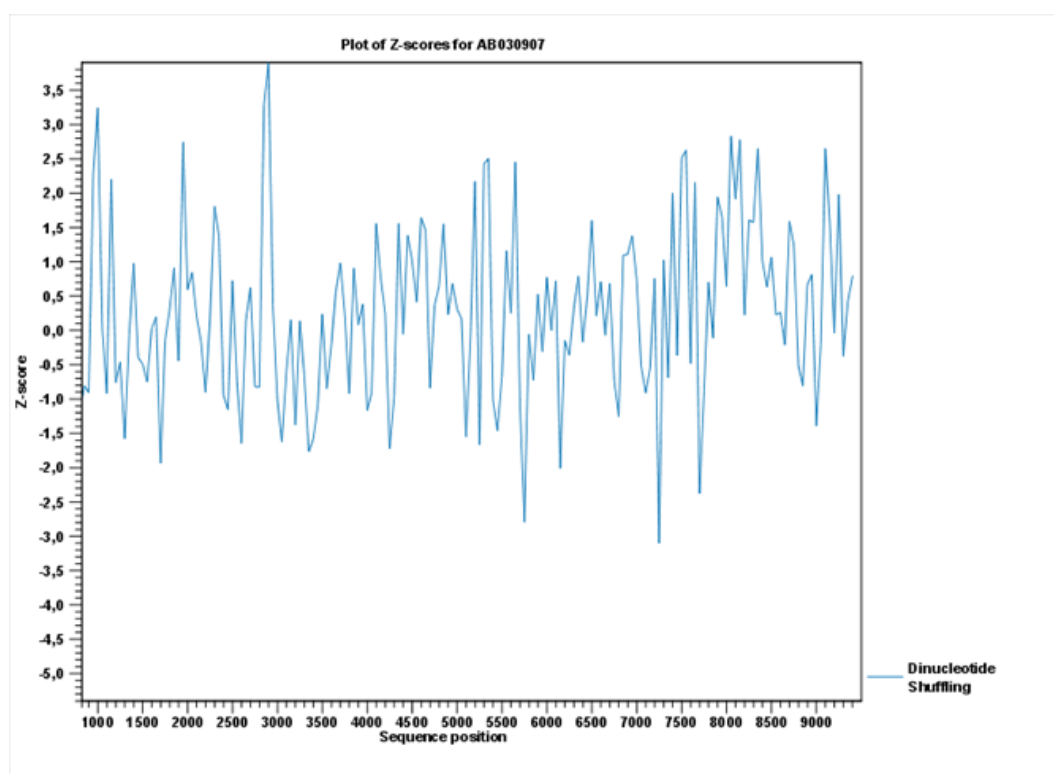

Figure 21.27: A plot of the Z-scores produced by sliding a window along a sequence.

21.5 Bioinformatics explained: RNA structure prediction by minimum free energy minimization

RNA molecules are hugely important in the biology of the cell. Besides their rather simple role as an intermediate messenger between DNA and protein, RNA molecules can have a plethora of biologic functions. Well known examples of this are the infrastructural RNAs such as tRNAs, rRNAs and snRNAs, but the existence and functionality of several other groups of non-coding RNAs are currently being discovered. These include micro- (miRNA), small interfering- (siRNA), Piwi interacting- (piRNA) and small modulatory RNAs (smRNA) [Costa, 2007].

A common feature of many of these non-coding RNAs is that the molecular structure is important

for the biological function of the molecule.

Ideally, biological function is best interpreted against a 3D structure of an RNA molecule. However, 3D structure determination of RNA molecules is time-consuming, expensive, and difficult [Shapiro et al., 2007] and there is therefore a great disparity between the number of known RNA sequences and the number of known RNA 3D structures.

However, as it is the case for proteins, RNA tertiary structures can be characterized by secondary structural elements. These are defined by hydrogen bonds within the molecule that form several recognizable "domains" of secondary structure like stems, hairpin loops, bulges and internal loops (see below). Furthermore, the high degree of base-pair conservation observed in the evolution of RNA molecules shows that a large part of the functional information is actually contained in the secondary structure of the RNA molecule.

Fortunately, RNA secondary structure can be computationally predicted from sequence data allowing researchers to map sequence information to functional information. The subject of this paper is to describe a very popular way of doing this, namely free energy minimization. For an in-depth review of algorithmic details, we refer the reader to [Mathews and Turner, 2006].

21.5.1 The algorithm

Consider an RNA molecule and one of its possible structures S_1 . In a stable solution there will be an equilibrium between unstructured RNA strands and RNA strands folded into S_1 . The propensity of a strand to leave a structure such as S_1 (the stability of S_1), is determined by the free energy change involved in its formation. The structure with the lowest free energy (S_{min}) is the most stable and will also be the most represented structure at equilibrium. The objective of minimum free energy (MFE) folding is therefore to identify S_{min} amongst all possible structures.

In the following, we only consider structures without pseudoknots, i.e. structures that do not contain any non-nested base pairs.

Under this assumption, a sequence can be folded into a single coherent structure or several sequential structures that are joined by unstructured regions. Each of these structures is a union of well described structure elements (see below for a description of these). The free energy for a given structure is calculated by an additive nearest neighbor model. Additive, means that the total free energy of a secondary structure is the sum of the free energies of its individual structural elements. Nearest neighbor, means that the free energy of each structure element depends only on the residues it contains and on the most adjacent Watson-Crick base pairs.

The simplest method to identify S_{min} would be to explicitly generate all possible structures, but it can be shown that the number of possible structures for a sequence grows exponentially with the sequence length [Zuker and Sankoff, 1984] leaving this approach unfeasible. Fortunately, a two step algorithm can be constructed which implicitly surveys all possible structures without explicitly generating the structures [Zuker and Stiegler, 1981]: The first step determines the free energy for each possible sequence fragment starting with the shortest fragments. Here, the lowest free energy for longer fragments can be expediently calculated from the free energies of the smaller sub-sequences they contain. When this process reaches the longest fragment, i.e., the complete sequence, the MFE of the entire molecule is known. The second step is called traceback, and uses all the free energies computed in the first step to determine S_{min} - the exact structure associated with the MFE. Acceptable calculation speed is achieved by using *dynamic programming* where sub-sequence results are saved to avoid recalculation. However, this comes

at the price of a higher requirement for computer memory.

The structure element energies that are used in the recursions of these two steps, are derived from empirical calorimetric experiments performed on small molecules see e.g. [Mathews et al., 1999].

Suboptimal structures determination

A number of known factors violate the assumptions that are implicit in MFE structure prediction. [Schroeder et al., 1999] and [Chen et al., 2004] have shown experimental indications that the thermodynamic parameters are sequence dependent. Moreover, [Longfellow et al., 1990] and [Kierzek et al., 1999], have demonstrated that some structural elements show non-nearest neighbor effects. Finally, single stranded nucleotides in multi loops are known to influence stability [Mathews and Turner, 2002].

These phenomena can be expected to limit the accuracy of RNA secondary structure prediction by free energy minimization and it should be clear that the predicted MFE structure may deviate somewhat from the actual preferred structure of the molecule. This means that it may be informative to inspect the landscape of suboptimal structures which surround the MFE structure to look for general structural properties which seem to be robust to minor variations in the total free energy of the structure.

An effective procedure for generating a sample of suboptimal structures is given in [Zuker, 1989a]. This algorithm works by going through all possible Watson-Crick base pair in the molecule. For each of these base pairs, the algorithm computes the most optimal structure among all the structures that contain this pair, see figure 21.28.

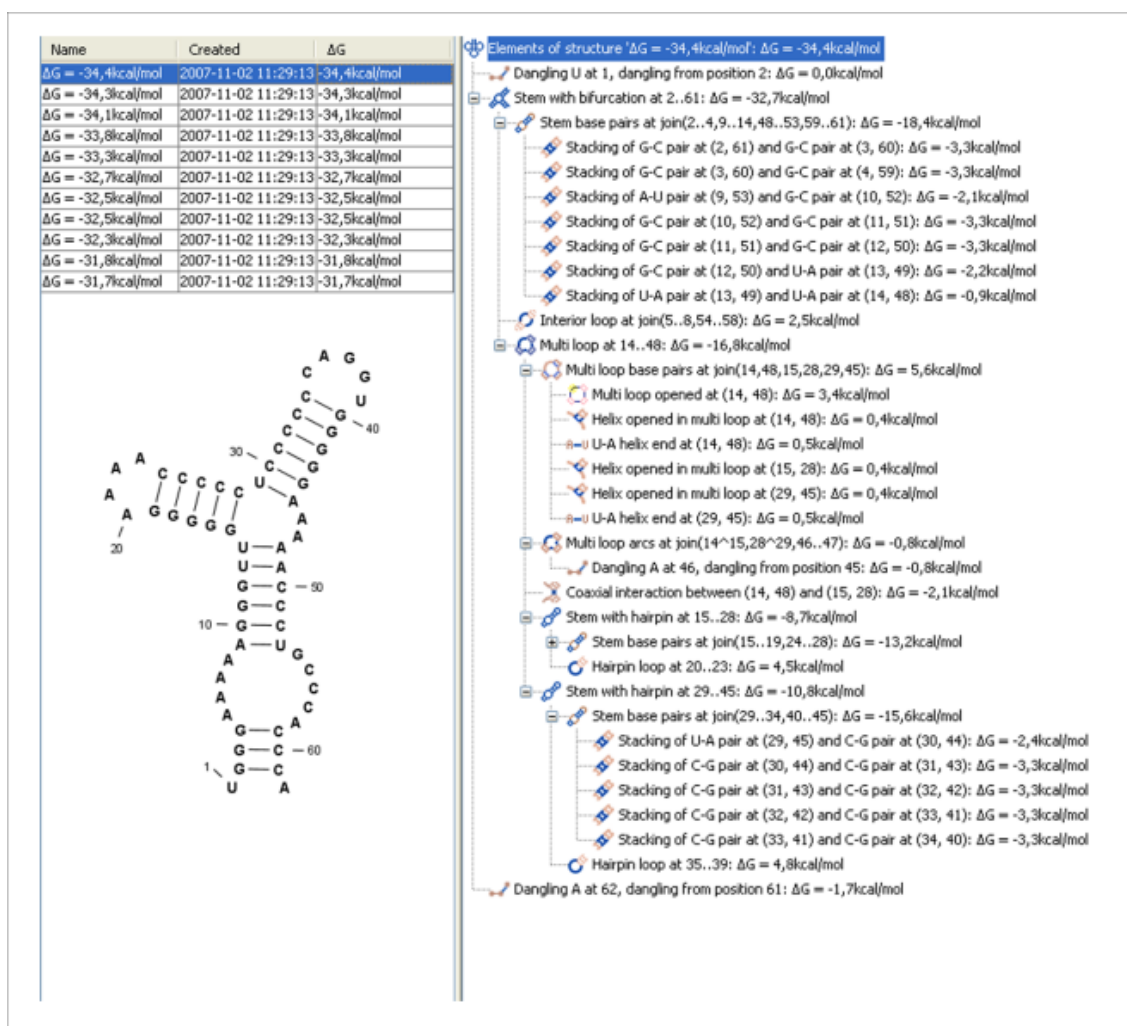

Figure 21.28: A number of suboptimal structures have been predicted using **CLC Genomics Workbench** and are listed at the top left. At the right hand side, the structural components of the selected structure are listed in a hierarchical structure and on the left hand side the structure is displayed.

21.5.2 Structure elements and their energy contribution

In this section, we classify the structure elements defining a secondary structure and describe their energy contribution.

Nested structure elements

The structure elements involving nested base pairs can be classified by a given base pair and the other base pairs that are nested and *accessible* from this pair. For a more elaborate description we refer the reader to [Sankoff et al., 1983] and [Zuker and Sankoff, 1984].

If the nucleotides with position number (i, j) form a base pair and $i < k, l < j$, then we say that the base pair (k, l) is **accessible** from (i, j) if there is no intermediate base pair (i', j') such that $i < i' < k, l < j' < j$. This means that (k, l) is nested within the pair i, j and there is no other base pair in between.

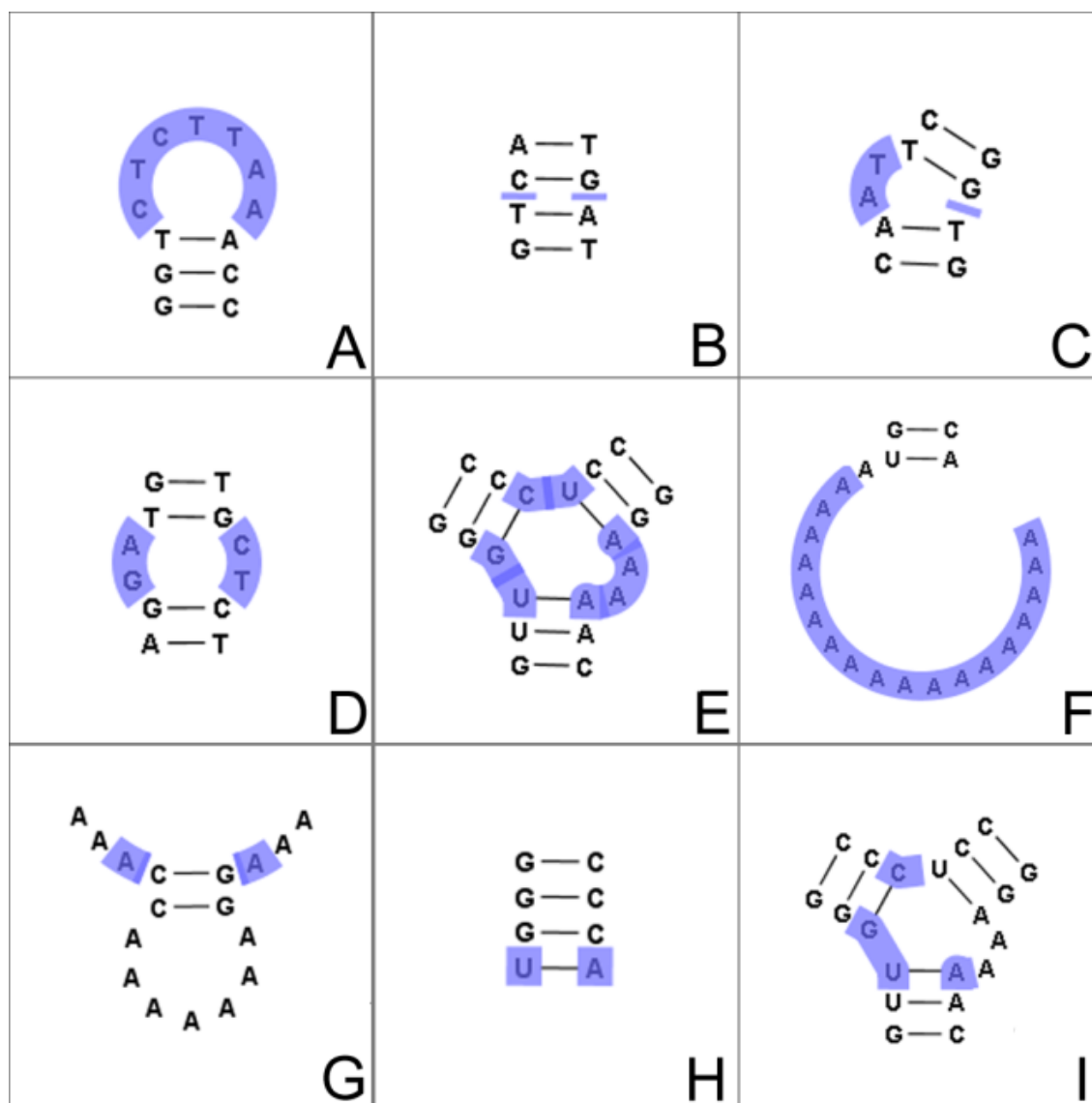









Figure 21.29: The different structure elements of RNA secondary structures predicted with the free energy minimization algorithm in **CLC Genomics Workbench**. See text for a detailed description.

Using the number of accessible base pairs, we can define the following distinct structure elements:

1. **Hairpin loop** (🔗). A base pair with 0 other accessible base pairs forms a *hairpin loop*. The energy contribution of a hairpin is determined by the length of the unpaired (loop) region and the two bases adjacent to the closing base pair which is termed a terminal mismatch (see figure 21.29A).
2. A base pair with 1 accessible base pair can give rise to three distinct structure elements:
 - **Stacking of base pairs** (🔗). A *stacking* of two consecutive pairs occur if $i' - i = 1 = j - j'$. Only canonical base pairs ($A - U$ or $G - C$ or $G - U$) are allowed (see figure 21.29B). The energy contribution is determined by the type and order of the two base pairs.

- **Bulge** (). A *bulge loop* occurs if $i' - i > 1$ or $j - j' > 1$, but not both. This means that the two base pairs enclose an unpaired region of length 0 on one side and an unpaired region of length ≥ 1 on the other side (see figure 21.29C). The energy contribution of a bulge is determined by the length of the unpaired (loop) region and the two closing base pairs.
 - **Interior loop** (). An *interior loop* occurs if both $i' - i > 1$ and $i - j' > 1$. This means that the two base pairs enclose an unpaired region of length ≥ 1 on both sides (see figure 21.29D). The energy contribution of an interior loop is determined by the length of the unpaired (loop) region and the four unpaired bases adjacent to the opening- and the closing base pair.
3. **Multi loop opened** (). A base pair with more than two accessible base pairs gives rise to a *multi loop*, a loop from which three or more stems are opened (see figure 21.29E). The energy contribution of a multi loop depends on the number of **Stems opened in multi-loop** () that protrude from the loop.

Other structure elements

- A collection of single stranded bases not accessible from any base pair is called an *exterior (or external) loop* (see figure 21.29F). These regions do not contribute to the total free energy.
- **Dangling nucleotide** (). A *dangling nucleotide* is a single stranded nucleotide that forms a stacking interaction with an adjacent base pair. A dangling nucleotide can be a 3' or 5'-dangling nucleotide depending on the orientation (see figure 21.29G). The energy contribution is determined by the single stranded nucleotide, its orientation and on the adjacent base pair.
- **Non-GC terminating stem** (). If a base pair other than a G-C pair is found at the end of a stem, an energy penalty is assigned (see figure 21.29H).
- **Coaxial interaction** (). Coaxial stacking is a favorable interaction of two stems where the base pairs at the ends can form a stacking interaction. This can occur between stems in a multi loop and between the stems of two different sequential structures. Coaxial stacking can occur between stems with no intervening nucleotides (adjacent stems) and between stems with one intervening nucleotide from each strand (see figure 21.29I). The energy contribution is determined by the adjacent base pairs and the intervening nucleotides.

Experimental constraints

A number of techniques are available for probing RNA structures. These techniques can determine individual components of an existing structure such as the existence of a given base pair. It is possible to add such experimental constraints to the secondary structure prediction based on free energy minimization (see figure 21.30) and it has been shown that this can dramatically increase the fidelity of the secondary structure prediction [Mathews and Turner, 2006].



Figure 21.30: *Known structural features can be added as constraints to the secondary structure prediction algorithm in **CLC Genomics Workbench**.*

Part IV

High-throughput sequencing

Chapter 22

Trimming, multiplexing and sequencing quality control

Contents

22.1 Trim Sequences	545
22.1.1 Quality trimming	546
22.1.2 Adapter trimming	547
22.1.3 Creating a new Trim adapter list	548
22.1.4 Length trimming	554
22.1.5 Trim output	554
22.2 Demultiplex reads	557
22.3 Sequencing data quality control	565
22.3.1 QC Sequencing Report Content	566
22.3.2 Adapters	569
22.3.3 Running the quality control tool	569
22.4 Merge overlapping pairs	569
22.4.1 Using quality scores when merging	571
22.4.2 Report of merged pairs	572

22.1 Trim Sequences

CLC Genomics Workbench offers a number of ways to trim your sequence reads prior to assembly and mapping, including adapter trimming, quality trimming and length trimming. For each original read, the regions of the sequence to be removed for each type of trimming operation are determined independently according to choices made in the trim dialogs. The types of trim operations that can be performed are:

1. Quality trimming based on quality scores
2. Ambiguity trimming to trim off stretches of Ns for example
3. Adapter trimming (with a Trim Adapter List, see section [22.1.2](#))

4. Base trim to remove a specified number of bases at either 3' or 5' end of the reads
5. Length trimming to remove reads shorter or longer than a specified threshold

The trim operation that removes the largest region of the original read from either end is performed while other trim operations are ignored as they would just remove part of the same region.

Note that this may occasionally expose an internal region in a read that has now become subject to trimming. In such cases, trimming may have to be done more than once.

The result of the trim is a list of sequences that have passed the trim (referred to as the trimmed list below) and optionally a list of the sequences that have been discarded and a summary report (list of discarded sequences). The original data will not be changed.

To start trimming:

Toolbox | NGS Core Tools (📁) | Trim Sequences (🔗)

This opens a dialog where you can add sequences or sequence lists. If you add several sequence lists, each list will be processed separately and you will get a list of trimmed sequences for each input sequence list.

When the sequences are selected, click **Next**.

22.1.1 Quality trimming

This opens the dialog displayed in figure 22.1 where you can specify parameters for quality trimming.

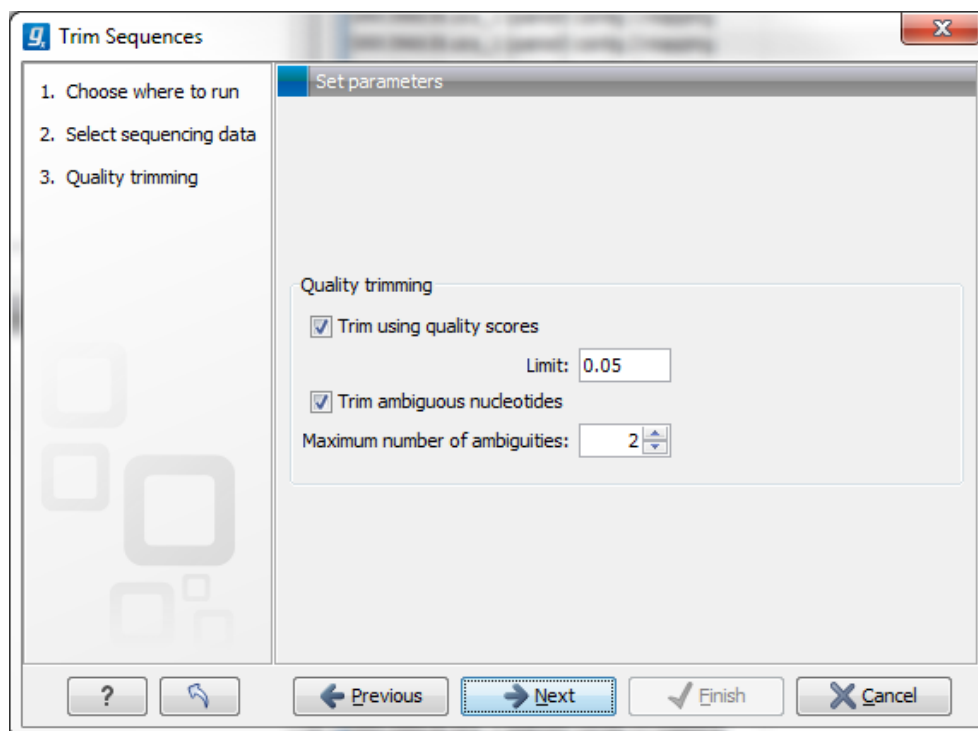

Figure 22.1: Specifying quality trimming.

The following parameters can be adjusted in the dialog:

- **Trim using quality scores.** If the sequence files contain quality scores from a base-caller algorithm this information can be used for trimming sequence ends. The program uses the modified-Mott trimming algorithm for this purpose (Richard Mott, personal communication):

Quality scores in the Workbench are on a Phred scale, and formats using other scales will be converted during import. The Phred quality scores (Q), defined as: $Q = -10\log_{10}(P)$, where P is the base-calling error probability, can then be used to calculate the error probabilities, which in turn can be used to set the limit for, which bases should be trimmed.

Hence, the first step in the trim process is to convert the quality score (Q) to an error probability: $p_{error} = 10^{-\frac{Q}{10}}$. (This now means that low values are high quality bases.)

Next, for every base a new value is calculated: $Limit - p_{error}$. This value will be negative for low quality bases, where the error probability is high.

For every base, the Workbench calculates the running sum of this value. If the sum drops below zero, it is set to zero. The part of the sequence not trimmed will be the region ending at the highest value of the running sum and starting at the last zero value before this highest score. Everything before and after this region will be trimmed. A read will be completely removed if the score never makes it above zero.

At <http://www.clcbio.com/files/usermanuals/trim.zip> you find an example sequence and an Excel sheet showing the calculations done for this particular sequence to illustrate the procedure described above.

- **Trim ambiguous nucleotides.** This option trims the sequence ends based on the presence of ambiguous nucleotides (typically N). Note that the automated sequencer generating the data must be set to output ambiguous nucleotides in order for this option to apply. The algorithm takes as input the *maximal number of ambiguous nucleotides allowed in the sequence after trimming*. If this maximum is set to e.g. 3, the algorithm finds the maximum length region containing 3 or fewer ambiguities and then trims away the ends not included in this region. The "Trim ambiguous nucleotides" option trims all types of ambiguous nucleotides (see Appendix H).

22.1.2 Adapter trimming

Clicking **Next** will allow you to specify adapter trimming (figure 22.2) .

Select an trim adapter list (see section 22.1.3 on how to create an adapter list) that defines the adapters to use.

You can specify if the adapter trimming should be performed in **Color space**. Note that this option is only available for sequencing data imported using the SOLiD import (see section 6.3.4). When doing the trimming in color space, the Smith-Waterman alignment is simply done using colors rather than bases. The adapter sequence is still input in base space, and the Workbench then infers the color codes. Note that the scoring thresholds apply to the color space alignment (this means that a perfect match of 10 bases would get a score of 9 because 10 bases are represented by 9 color residues). Learn more about color space in section 24.4.

Checking the **Search on both strands** checkbox will search both the minus and plus strand for the adapter sequence. **Note!** If a match is found on the reverse strand the Trim action will

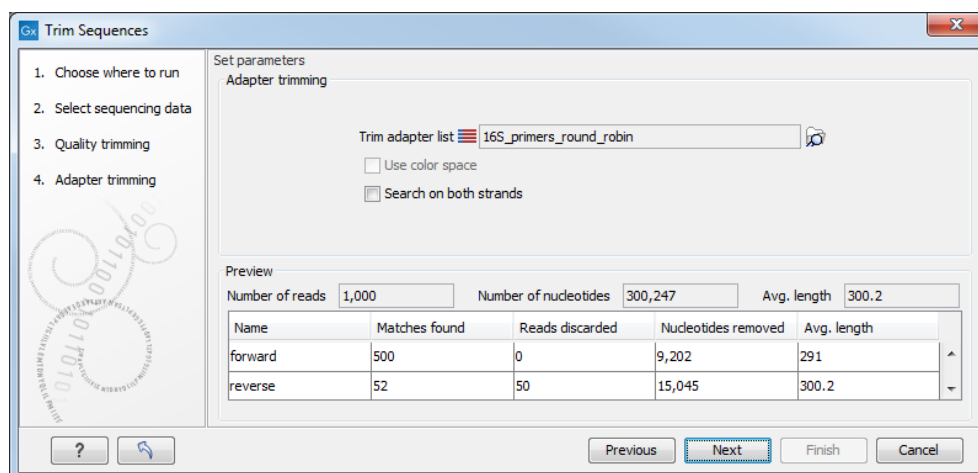

Figure 22.2: Trimming your sequencing data for adapter sequences.

reverse complement the read before trimming and output the trimmed reverse complement. Its intended use is for removal of multiplexing barcodes and primers.

Below you find a preview listing the results of trimming with the current settings on 1000 reads in the input file (reads 1001-2000 when the read file is long enough). This is useful for a quick feedback on how changes in the parameters affect the trimming (rather than having to run the full analysis several times to identify a good parameter set). The following information is shown:

- **Name.** The name of the adapter.
- **Matches found.** Number of matches found based on the strand and alignment score settings.
- **Reads discarded.** This is the number of reads that will be completely discarded. This can either be because they are completely trimmed (when the **Action** is set to Remove adapter and the match is found at the 3' end of the read), or when the **Action** is set to Discard when found or Discard when not found.
- **Nucleotides removed.** The number of nucleotides that are trimmed include both the ones coming from the reads that are discarded and the ones coming from the parts of the reads that are trimmed off.
- **Avg. length** This is the average length of the reads that are retained (excluding the ones that are discarded).

Note that the preview panel is only showing how the adapter trim affects the results. If other kinds of trimming (quality or length trimming) is applied, this will not be reflected in the preview but still influence the results.

22.1.3 Creating a new Trim adapter list

In order to trim for adapters, you have to create an adapter list first that must be supplied to the trim tool. A new adapter trim list can be created here:

File | New | Trim Adapter List

This will create a new empty trim adapter list. Add the adapter(s) that you would like to use for trimming by clicking on the button **Add Row** (+) found at the bottom of the View Area (figure 22.3). Provide the name and sequence of the adapter that should be trimmed away and adjust the parameters if relevant.

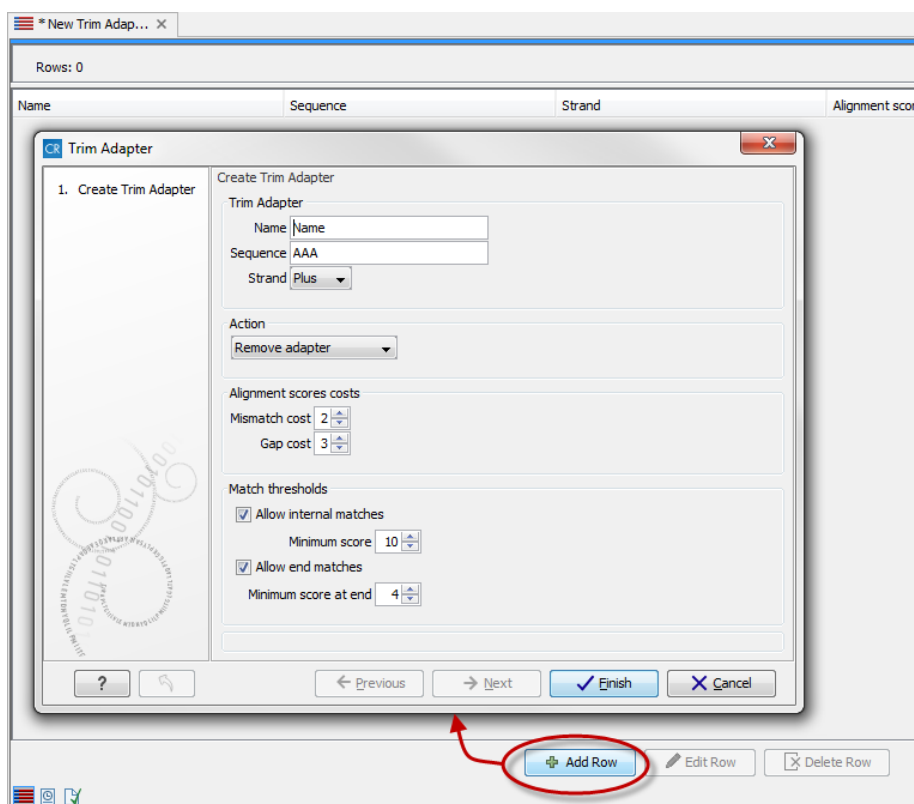

Figure 22.3: Create a new Adapter Trim List by clicking on the button labeled "Add Row" found at the bottom of the New Trim Adapter view.

The information to be added for each adapter is explained in the following sections, going into detail with the adapter trim.

At the bottom of the view, you have the following options that allow you to keep on editing the adapter trim list:

- **Add Rows.** Add a new adapter.
- **Delete Row.** Delete the selected adapter.
- **Edit Row.** Edit the selected adapter. This can also be achieved by double-clicking the row in the table.

Click on the button labeled **Finish** to create the adapter trim list. You must now save the generated adapter trim list in the **Navigation Area**. You can do this by clicking on the tab and dragging and dropping the adapter trim list to the desired destination, or you can go to **File** in the menu bar and choose **Save as**.

Guideline to simplify the creation of trim adapter list in some common cases.

Sequencing adapters

When you are analyzing sequencing data, the adapters must be trimmed off before you proceed with further analysis. The removal of adapters is often done directly on the sequencing machine, but in some cases, some adapters remain on the sequenced reads. The presence of remaining adapters can lead to misleading results, so we recommend to trim them off the reads.

If you have Illumina sequencing data for which adapter sequences have not been trimmed, or have been trimmed incompletely, the adapter sequences can be removed within the *CLC Genomics Workbench* using the Illumina adapter sequences that can be found here:

<http://support.illumina.com/downloads/illumina-customer-sequence-letter.html>

With Illumina adapters, the 5'end adapter is not sequenced, so adapters will always be found on the 3'end and thus need to be searched for on the Minus strand.

When creating the Trim Adapter List with **Nextera** adapters, their sequenced can be entered in forward orientation and should be searched on the Minus strand. A detailed step-by step description on how to remove Nextera adapters can be found here <https://secure.clcbio.com/helpspot/index.php?pg=kb.page&id=384>.

TruSeq adapters are ligated to the DNA fragments using TA overhangs. When creating the Trim Adapter List with TruSeq adapters, the Universal adapter can be entered in forward orientation and searched on the Minus strand. The Universal adapter already has a "T" in the end from the T-overhang in the TA ligation, so no additional "T" needs to be added to this sequence. However, the TruSeq Index adapter must be reverse-complemented: to simplify the list, only copy and reverse complement the part from the 5'end of the adapter that is common to all adapter indexes. Then paste it in the Trim Adapter list and add a "T" to the right-hand end of the reverse c-complemented adapter sequence. Finally set the strand to Minus. A more detailed step-by step description on how to remove TruSeq adapters can be found here <https://secure.clcbio.com/helpspot/index.php?pg=kb.page&id=377>.

Note: To create an Adapter List file with the adapter sequences that have traditionally been provided with the Genomics Workbench, please go to **Edit | Preferences**. In the "Data section" of this panel you will find the adapter sequences. Please select the rows of your desired adapter sequences, then click the **Convert Trim Adapters** button. This will create an Adapter List for use in the Adapter trimming tool.

You can also create an adapter list by importing a comma separated value (.csv) file of your Adapters. This import can be performed with the standard import using either the Automatic Import option or Force Import as Type: Trim Adapter List. To import a csv file, the names of all adapters must be unique - the Workbench is unable to accept files with multiple rows containing the same adapter name. Additionally, the text between each comma that designates a new column should be quoted. The expected import format for Adapter Lists appears as shown in

figure 22.4:

```
"Name", "Sequence", "Strand", "Alignment score", "Action"
"Adapter 1", "AAATTGTC", "Plus", "Mismatch: 2, Gapcost: 3, Cutoff: 10, Cutoff at end: 4", "Remove adapter"
"Adapter 2", "AAACGCCT", "Plus", "Mismatch: 2, Gapcost: 3, Cutoff: 10, Cutoff at end: 4", "Remove adapter"
```

Figure 22.4: *The expected import format for Adapter Lists.*

You can also create an Excel file (.xlsx or .xls) format. In this case, you include the same information per column as indicated above, but do not include the quotes within Excel.

Strand settings

Each adapter is defined as either **Plus** or **Minus**. Note that all the definitions above regarding 3' end and 5' end also apply to the minus strand (i.e. selecting the Minus strand is equivalent to reverse complementing all the reads). The adapter in this case should be defined as you would see it on the plus strand of the reverse complemented read. The example below (figure 22.5) shows a few examples of an adapter defined on the minus strand. It shows hits for an adapter sequence defined as CTGCTGTACGGCCAAGGCG, searching on the minus strand.

```
a)      ACCGAGAAACGCCTTGGCCGTACAGCAG
          |||
          19 matches = 19
          GGGGAAACGCCTTGGCCGTACAGCAG

b)      ACCGATAAACGCCTTGGCCGTACAGCAGATGCC
          |||
          18 matches - 2 mismatches = 16
          GGGGAAACGCCTTGGCCGTACAGCAG
```

Figure 22.5: *An adapter defined as CTGCTGTACGGCCAAGGCG searching on the minus strand. Red is the part that is removed and green is the retained part. The retained part is 3' of the match on the minus strand, just like matches on the plus strand.*

You can see that if you reverse complemented the adapter you would find the hit on the plus strand, but then you would have trimmed the wrong end of the read. So it is important to define the adapter as it is, without reverse complementing.

Trimming of 3' ends of the reads

To trim an adapter and everything to the 3' end of the adapter you will need to search for the reverse complement of the adapter on the negative strand. This is achieved by creating a new Trim Adapter List from the reverse complement of your adapter sequence, choosing the minus strand of your reads and run adapter trimming with the new Trim Adapter List as input.

Action to perform when a match is found

When the first match for a given adapter is found on a read sequence, the Trim tool acts based on the action specified for that adapter. There are three actions to choose from:

- **Remove adapter** The adapter and all the nucleotides 5' of the match are removed when a match is found. All the nucleotides 3' of the adapter match will be preserved in the read, which is retained in the trimmed reads list. If there are no nucleotides 3' of the adapter match, the read is placed in the list of discarded sequences (see section 22.1.5).
- **Discard when not found** The read sequence is trimmed, as described above for the Remove adapter option, if a match is found. However, if no match is found, the read sequence is

placed in the list of discarded sequences. This kind of adapter trimming is useful for small RNA sequencing where the remnants of the adapter is an indication that this is indeed a small RNA. Note that if an adapter list contains multiple adapters marked "Discard when not found", then only sequences containing all the adapters will be retained in the list of trimmed reads.

- **Discard when found** The read is placed in the list of discarded sequences. If no match is found, the read is retained in the list of trimmed reads. This can be used for quality checking the data for linker contamination, etc.

Alignment scoring and match thresholds

For each read sequence in the input, a Smith-Waterman alignment [Smith and Waterman, 1981] is carried out with each adapter sequence. Alignment scores are computed and compared to the minimum scores provided for each adapter when setting up the Adapter List (figure 22.3). A lower score is usual when considering matches to adapters found at the end of sequences, where the adapter sequence may be incomplete. When the alignment score surpasses the relevant minimum score, the action specified for that adapter will be taken.

- **Matches** An A,C,G or T in the adapter that matches an A,C,G or T respectively - or a corresponding ambiguity code letter - in a sequence is considered a match and will be awarded 1 point.
- **Mismatches** The penalty for mismatches between bases is specified in the Adapter List.
- **Gap** The penalty for gaps introduced into the alignment is specified in the Adapter List.

By default a mismatch costs 2 and a gap (insertion or deletion) costs 3. A few examples of adapter matches and corresponding scores are shown in figure 22.6.

a)	CGTATCAATCGATTACGCTATGAATG TCCAATCGGTTAC	11 matches - 2 mismatches = 7
b)	CGTATCAATCGATTTCGCTATGAATG ATCAATCGAT-CGCT	14 matches - 1 gap = 11
c)	CGTATCAATCGATTACGCTATGAATG TCCAATCGGG	7 matches - 3 mismatches = 1

Figure 22.6: Three examples showing a sequencing read (top) and an adapter (bottom). The examples are artificial, using default setting with mismatch costs = 2 and gap cost = 3.

Note that there is a difference between an **internal match** and an **end match**. The examples above are all internal matches where the alignment of the adapter falls within the read. Figure 22.7 shows a few examples with an adapter match at the end.

In the first two examples (d and e), the adapter sequence extends beyond the end of the read. This is what typically happens when sequencing small RNAs where you sequence part of the adapter. The third example (f) shows a case that could be interpreted both as an end match and an internal match. However, the workbench will interpret this as an end match, because it starts

```

d)          CGTATCAATCGATTACGCTATGAATG
           |||||
GATTCGTAT          5 matches = 5 (as end match)

e)          CGTATCAATCGATTACGCTATGAATG
           || ||||
GATTCGCATCA       6 matches - 1 mismatch = 4 (as end match)

f)          CGTATCAATCGATTACGCTATGAATG
           |||| |||||
CGTA-CAATC       9 matches - 1 gap = 6 (as end match)

g)          CGTATCAATCGATTACGCTATGAATG
           ||||| |||||
           GCTATGAATG       10 matches = 10 (as internal match)

```

Figure 22.7: Four examples showing a sequencing read (top) and an adapter (bottom). The examples are artificial.

at beginning (5' end) of the read. Thus, the definition of an end match is that the alignment of the adapter starts at the read's 5' end. The last example (g) could also be interpreted as an end match, but because it is at the 3' end of the read, it counts as an internal match (this is because you would not typically expect partial adapters at the 3' end of a read). Also note, that if **Remove adapter** is chosen for the last example, the full read will be discarded because everything 5' of the adapter is removed.

Below (figure 22.8), the same examples are re-iterated showing the results when applying different scoring schemes. In the first round, the settings are:

- Allowing internal matches with a minimum score of 6
- Not allowing end matches
- Action: Remove adapter

A different set of adapter settings could be:

- Allowing internal matches with a minimum score of 11
- Allowing end match with a minimum score of 4
- Action: Remove adapter

The results of such settings is shown in figure 22.9.

a)	<pre> CGTATCAATCGATTACGCTATGAATG TTCAATCGGTTAC </pre>	11 matches - 2 mismatches = 7
b)	<pre> CGTATCAATCGATTACGCTATGAATG ATCAATCGAT-ACGC </pre>	14 matches - 1 gap = 11
c)	<pre> CGTATCAATCGATTACGCTATGAATG TTCAATCGGG </pre>	7 matches - 3 mismatches = 1
d)	<pre> CGTATCAATCGATTACGCTATGAATG GATTCGTAT </pre>	5 matches = 5 (as end match)
e)	<pre> CGTATCAATCGATTACGCTATGAATG GATTCGCATCA </pre>	6 matches - 1 mismatch = 4 (as end match)
f)	<pre> CGTATCAATCGATTACGCTATGAATG CGTA-CAATC </pre>	9 matches - 1 gap = 6 (as end match)
g)	<pre> CGTATCAATCGATTACGCTATGAATG GCTATGAATG </pre>	10 matches = 10 (as internal match)

Figure 22.8: The results of trimming with internal matches only. Red is the part that is removed and green is the retained part. Note that the read at the bottom is completely discarded.

22.1.4 Length trimming

Clicking **Next** will allow you to specify length trimming as shown in figure 22.10.

At the top you can choose to **Trim bases** by specifying a number of bases to be removed from either the 3' or the 5' end of the reads. Below you can choose to **Discard reads below length**. This can be used if you wish to simply discard reads because they are too short. Similarly, you can discard reads above a certain length. This will typically be useful when investigating e.g. small RNAs (note that this is an integral part of the small RNA analysis together with adapter trimming).

22.1.5 Trim output

Clicking **Next** will allow you to specify the output of the trimming as shown in figure 22.11.

No matter what is chosen here, the list of trimmed reads will always be produced. In addition the following can be output as well:

- **Save discarded sequences.** This will produce a list of reads that have been discarded during trimming. Sections trimmed from reads that are not themselves discarded will not appear in this list.
- **Save broken pairs.** This will produce a list of orphan reads.

a)	<pre> CGTATCAATCGATTACGCTATGAATG TTCAATCGGTAC </pre>	11 matches - 2 mismatches = 7
b)	<pre> CGTATCAATCGATTACGCTATGAATG ATCAATCGAT-CGCT </pre>	14 matches - 1 gap = 11
c)	<pre> CGTATCAATCGATTACGCTATGAATG TTCAATCGGG </pre>	7 matches - 3 mismatches = 1
d)	<pre> CGTATCAATCGATTACGCTATGAATG GATTCGTAT </pre>	5 matches = 5 (as end match)
e)	<pre> CGTATCAATCGATTACGCTATGAATG GATTCGCATCA </pre>	6 matches - 1 mismatch = 4 (as end match)
f)	<pre> CGTATCAATCGATTACGCTATGAATG CGTA-CAATC </pre>	9 matches - 1 gap = 6 (as end match)
g)	<pre> CGTATCAATCGATTACGCTATGAATG GCTATGAATG </pre>	10 matches = 10 (as internal match)

Figure 22.9: The results of trimming with both internal and end matches. Red is the part that is removed and green is the retained part.

- **Create report.** An example of a trim report is shown in figure 22.12. The report includes the following:
 - **Trim summary.**
 - * **Name.** The name of the sequence list used as input.
 - * **Number of reads.** Number of reads in the input file.
 - * **Avg. length.** Average length of the reads in the input file.
 - * **Number of reads after trim.** The number of reads retained after trimming. This includes both paired and orphan reads.
 - * **Percentage trimmed.** The percentage of the input reads that are retained.
 - * **Avg. length after trim.** The average length of the retained sequences.
 - **Read length before / after trimming.** This is a graph showing the number of reads of various lengths. The numbers before and after are overlaid so that you can easily see how the trimming has affected the read lengths (right-click the graph to open it in a new view).
 - **Trim settings** A summary of the settings used for trimming.
 - **Detailed trim results.** A table with one row for each type of trimming:
 - * **Input reads.** The number of reads used as input. Since the trimming is done sequentially, the number of retained reads from the first type of trim is also the number of input reads for the next type of trimming.

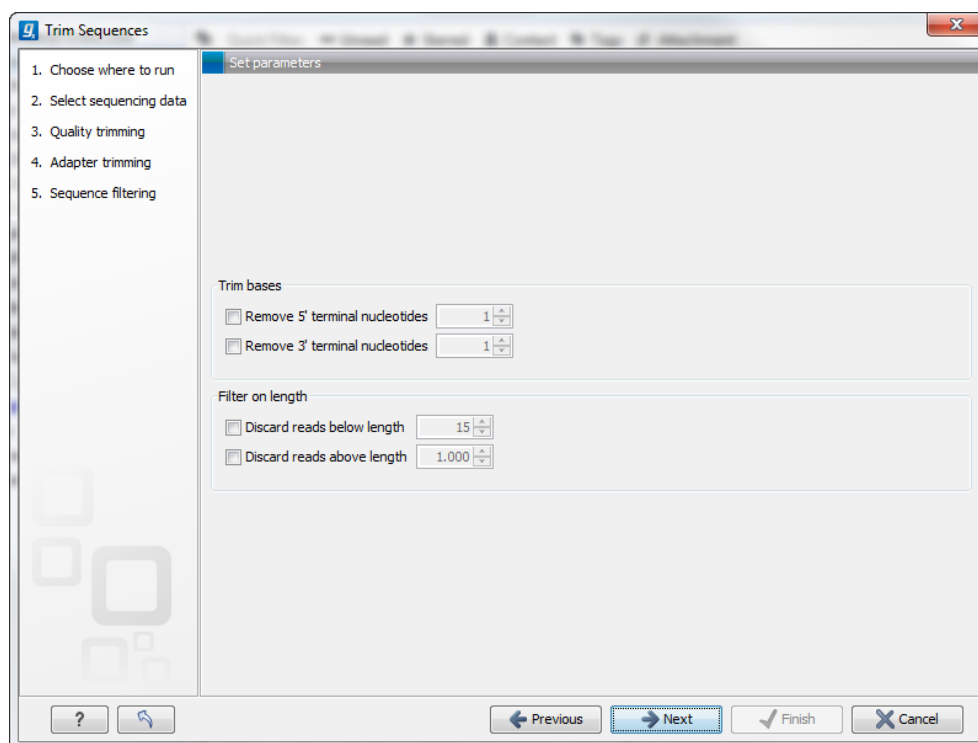
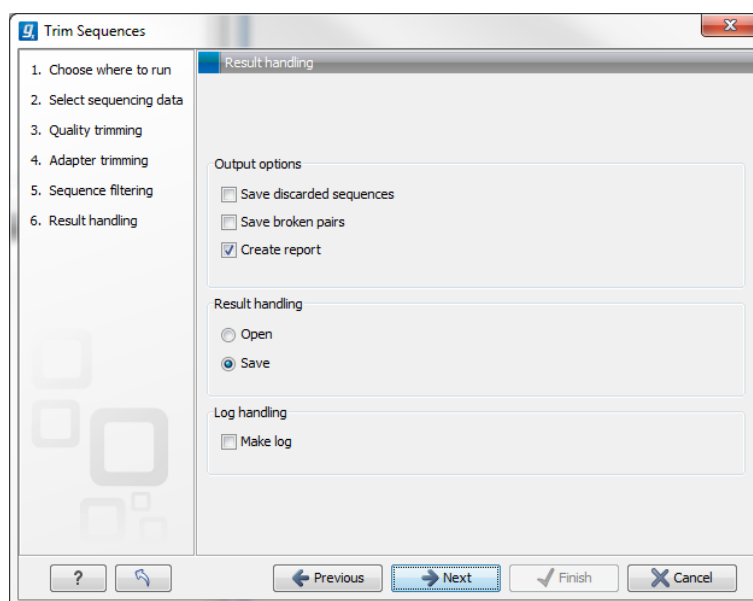
Figure 22.10: *Trimming on length.*Figure 22.11: *Specifying the trim output.*

- * **No trim.** The number of reads that have been retained, unaffected by the trimming.
- * **Trimmed.** The number of reads that have been partly trimmed. This number plus the number from **No trim** is the total number of retained reads.
- * **Nothing left or discarded.** The number of reads that have been discarded either because the full read was trimmed off or because they did not pass the length trim (e.g. too short) or adapter trim (e.g. if **Discard when not found** was chosen for the adapter trimming).

1 Trim summary

Name	Number of reads	Avg.length	Number of reads after trim	Percentage trimmed	Avg.length after trim
reads	57.213	228,0	55.754	~100%	232,8

2 Read length before / after trimming

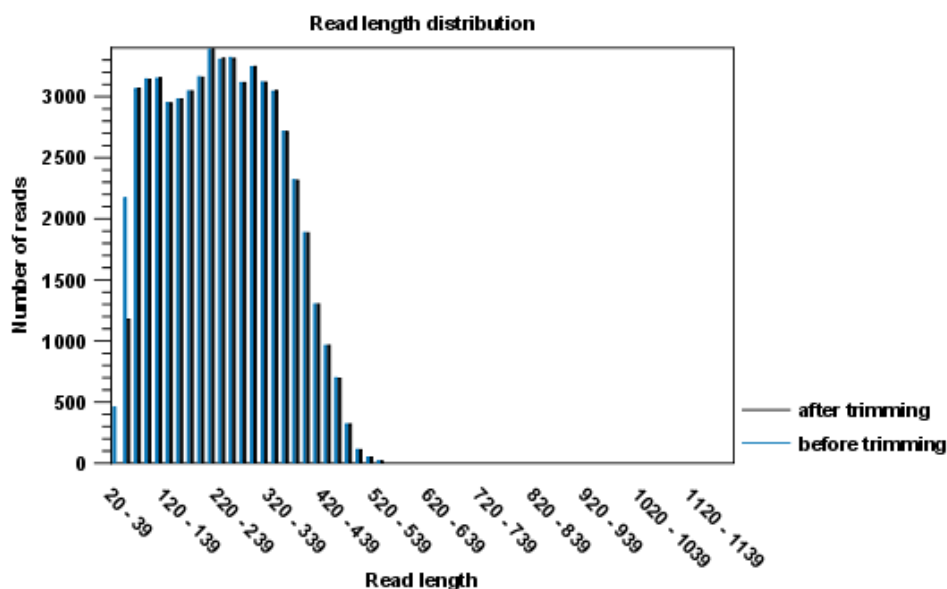

Figure 22.12: A report with statistics on the trim results. Note that the Average length after trimming (232,8bp) is bigger than before trimming (228bp) because 2.000 very short reads were discarded in the trimming process.

Click **Next** if you wish to adjust how to handle the results (see section 8.2). If not, click **Finish**. This will start the trimming process.

If you trim paired data, the result will be a bit special. In the case where one part of a paired read has been trimmed off completely, you no longer have a valid paired read in your sequence list. In order to use paired information when doing assembly and mapping, the Workbench therefore creates two separate sequence lists: one for the pairs that are intact, and one for the single reads where one part of the pair has been deleted. When running assembly and mapping, simply select both of these sequence lists as input, and the Workbench will automatically recognize that one has paired reads and the other has single reads.

22.2 Demultiplex reads

Multiplexing techniques are often used when sequencing different samples in one sequencing run. One method used is to *tag* the sequences with a unique identifier during the preparation of the sample for sequencing [Meyer et al., 2007].

With this technique, each sequence read will have a sample-specific tag, which is a specific sequence of nucleotides before and after the sequence of interest. This principle is shown in figure 22.13.

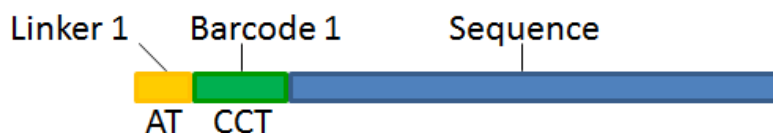

Figure 22.13: Tagging the target sequence, which in this case is single reads from one sample.

The sample-specific tag, also called the barcode or the index, can then be used to distinguish between the different samples when analyzing the sequencing data.

Post-processing of the sequencing data is required to separate the reads into their corresponding samples. Based on their barcodes this can be done using the demultiplexing functionality of the *CLC Genomics Workbench*. Using this tool, sequences are associated with a particular sample when they contain an exact match to a particular barcode. Sequences that do not contain an exact match to any of the barcode sequences provided are classified as not grouped and are put into a sequence list with the name "Not grouped".

Note that there is also an example using Illumina data at the end of this section.

Before processing the data, you need to import it as described in section 6.3.

Please note that demultiplexing is often carried out on the sequencing machine so that the sequencing reads are already separated according to sample. This is often the best option, if it is available to you. Of course, in such cases, the data will not need to be demultiplexed again after import into the *CLC Genomics Workbench*.

To demultiplex your data, please go to:

Toolbox | NGS Core Tools (📁) | Demultiplex Reads (🔍)

This opens a dialog where you can specify the sequences to process (figure 22.14).

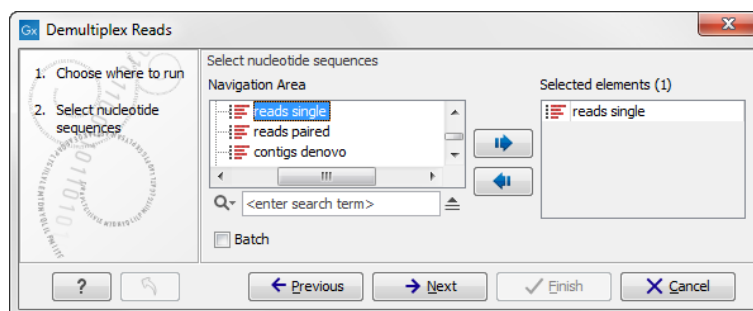

Figure 22.14: Specify the sequences to demultiplex.

When you click on the button labeled **Next**, you can then specify the details of how the demultiplexing should be performed. At the bottom of the dialog, there are three buttons, which are used to **Add**, **Edit**, and **Delete** the elements that describe how the barcode is embedded in the sequences.

First, click **Add** to define the first element. This will bring up the dialog shown in 22.15.

At the top of the dialog, you can choose the type of element you wish to define:

- **Linker.** The linker (also known as adapter) is a sequence which should just be ignored - it is neither the barcode nor the sequence of interest. In the example in figure 22.13, the

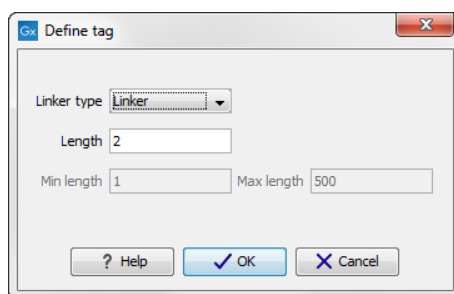

Figure 22.15: Defining an element of the barcode system.

linker is two nucleotides long. For this element, you simply define its length - nothing else.

- **Barcode.** The barcode (also known as index) is the stretch of nucleotides used to group the sequences. In this dialog, you simply need to specify the length of the barcode. The valid sequences for your barcodes must be provided at a later wizard step.
- **Sequence.** This element defines the sequence of interest. You can define a length interval for how long you expect this sequence to be. The sequence part is the only part of the read that is retained in the output. Both barcodes and linkers are removed.

The concept when adding elements is that you add e.g. a linker, a barcode, and a sequence in the desired sequential order to describe the structure of each sequencing read. You can of course edit and delete elements by selecting them and clicking the buttons below. In the example shown in figure 22.13, the dialog should include a linker, a barcode, and a sequence as shown in figure 22.16.

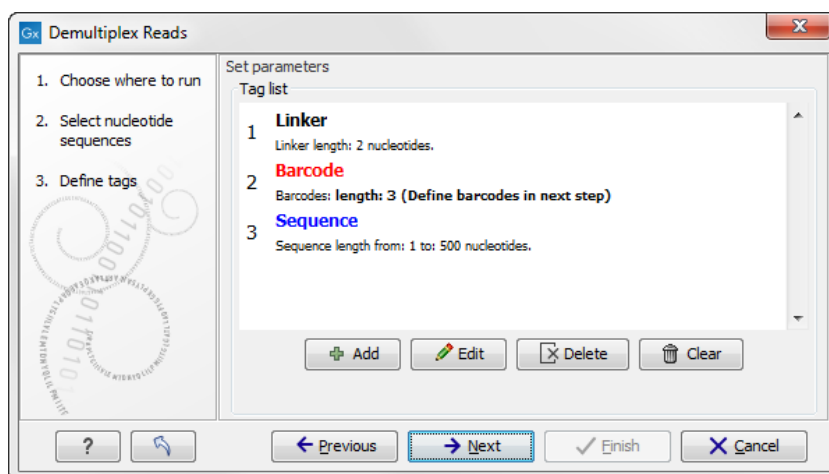

Figure 22.16: Processing the tags as shown in the example of figure 22.13.

Click on the button labeled **Next** to go to the last wizard step, where you can specify the output options. If you choose to keep the default settings, three different types of output will be generated; 1) The demultiplexed reads, one output for each specified barcode (the file name starts with "Barcode:" and is followed by the specified barcode sequence), 2) The discarded reads that did not have a barcode (this file is called "Not grouped"), and 3) a "Demultiplex Reads report", which shows the fraction of reads with and without a barcode (see figure 22.17).

If you have paired data the procedure is exactly the same, except for one thing: the dialog shown in figure 22.16 will be displayed twice - one for each part of the pair.

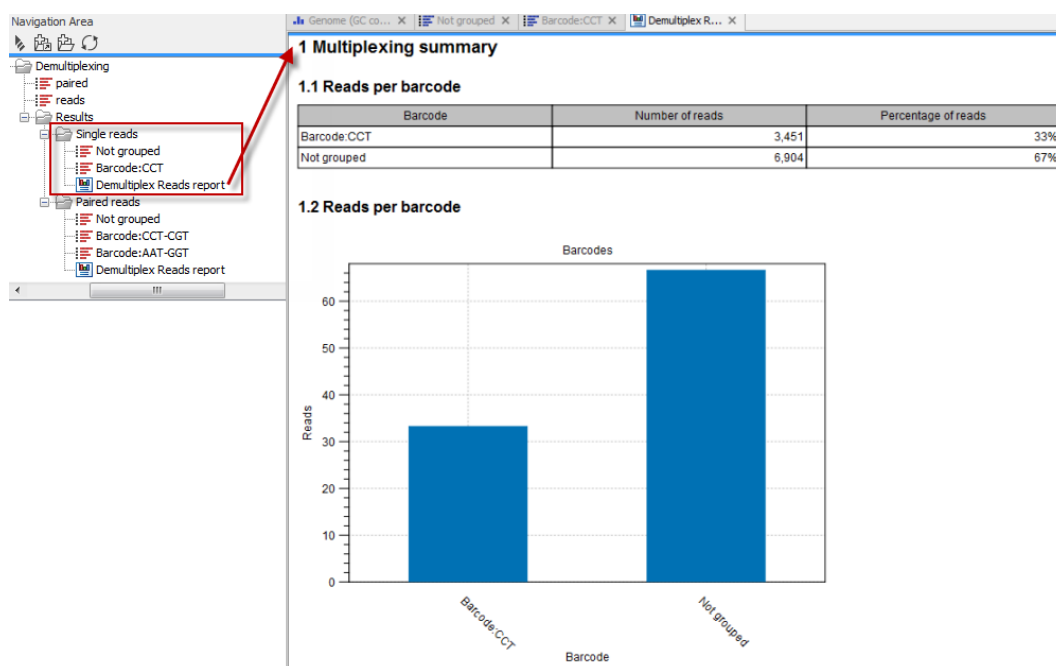

Figure 22.17: Three different outputs are generated when analyzing single reads with only one sample using the default output settings. If several samples had been mixed together there would be a sequence list for each sample (each specified barcode). The Demultiplex Reads report is shown in the right-hand side of the figure.

Figure 22.18 shows an example that could illustrate paired end reads. In this example we have paired end reads from two different samples mixed together.

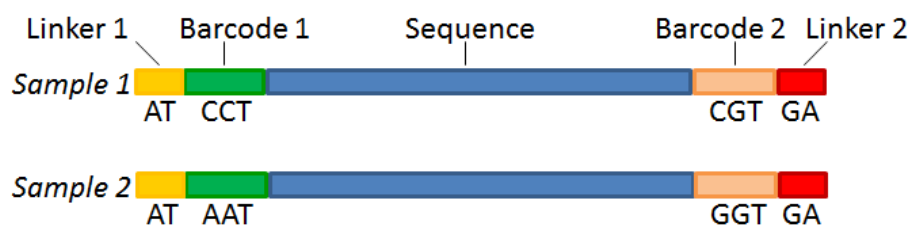

Figure 22.18: Paired end reads with linkers and barcodes. Two different samples are mixed together in this example.

In a situation where the paired reads are expected to be barcoded in the same way (see example below), you would set the parameters for read1 (wizard step 3) and read2 (wizard step 4) to be the same.

Read1 : -Linker-Barcode1-Sequence

Read2 : -Linker-Barcode1-Sequence

However, if read2 of the pair is not expected to be the same as read1 in the pair, it is necessary to adjust these settings accordingly. For example, it is possible that read2 does not contain any barcode sequence at all. In this case, you would simply set the sequence parameter for the mate and exclude the barcode and linker parameters. If the two reads in the read pair have different

barcodes, the situation would look like this:

Read1 : -Linker-Barcode1-Sequence

Read2 : -Linker-Barcode2-Sequence

To demultiplex paired end reads the first two steps are similar to the demultiplexing of single reads. Select the paired end read sequences that should be demultiplexed (figure 22.19).

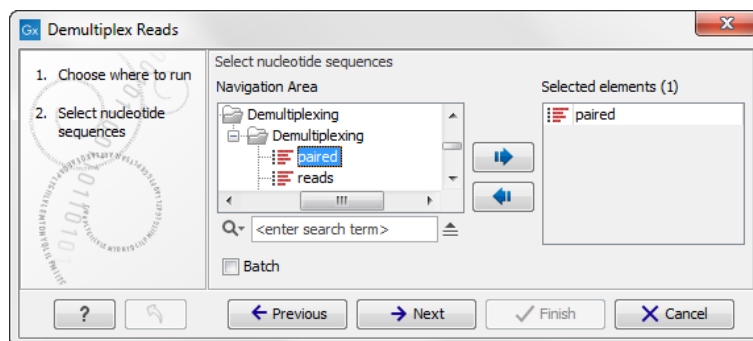

Figure 22.19: Specifying the paired end reads to demultiplex.

Click on the button labeled **Next** to define the tags and sequence for the forward reads (figure 22.20).

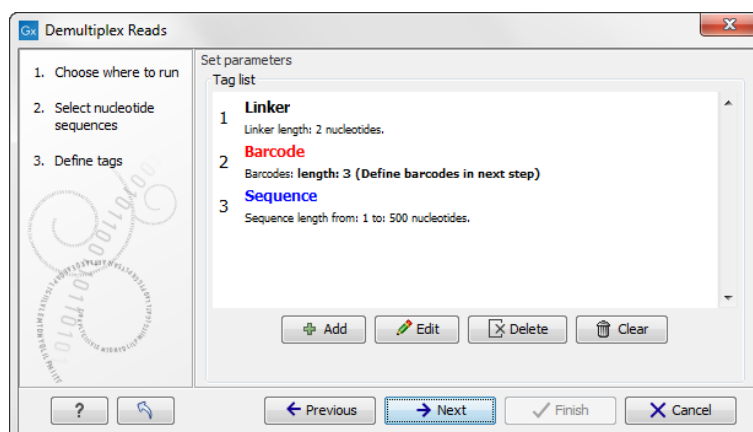

Figure 22.20: Specifying the setup of the forward read (tags and sequence).

Barcodes can be entered manually or imported from a properly formatted CSV or Excel file:

Manually The barcodes can be entered manually by clicking the **Add** (➡) button. In the example shown in figure 22.18 the barcodes should be defined as shown in figure 22.21.

You can edit the barcodes and the names by clicking the cells in the table. The barcode name is used when naming the results.

Import from CSV or Excel To import a file of barcodes, click on the **Import** (📁) button. The input format consists of two columns: the first contains the barcode sequence, the second contains the name of the barcode. An acceptable csv format file would contain columns of information that looks like:

```
"AAAAAA", "Sample1"
"GGGGGG", "Sample2"
"CCCCCC", "Sample3"
```

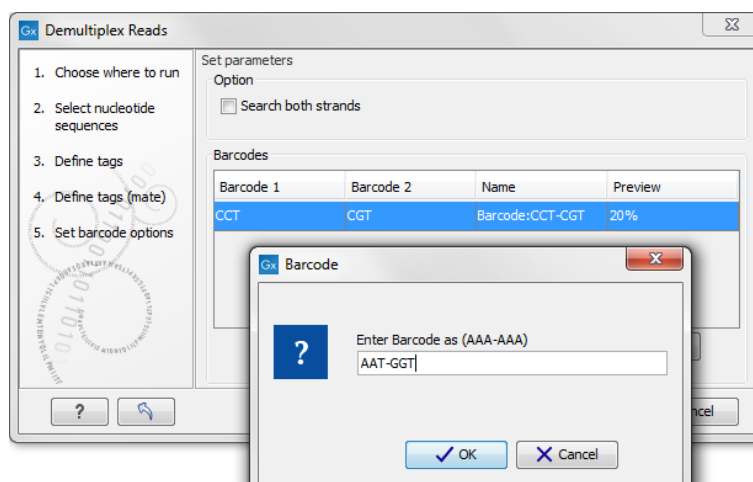

Figure 22.21: The barcodes for the set of paired end reads for sample 1 have already been defined and the barcodes for sample 2 is being entered in the format AAA-AAA, which corresponds to Barcode1-Barcode2 for sample 2 in the example shown in figure 22.18.

Note that double quotes around values are always necessary regardless of whether columns are separated with a comma or a semi-colon.

The **Preview** column will show a preview of the results by running through the first 10,000 reads (figure 22.22).

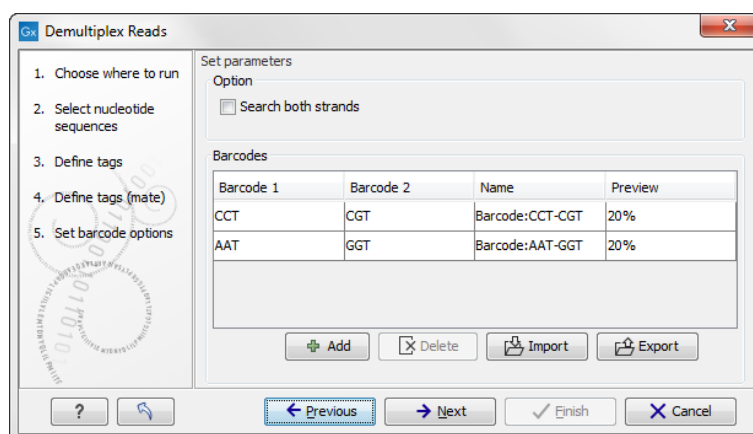

Figure 22.22: A preview of the results.

At the top, you can choose to search on both strands for the barcodes (this is needed for some 454 protocols where the MID is located at either end of the read).

If you would like to change the name of the sequence(s), this can be done at this step by double-clicking on the specific name that you would like to change. This is shown in figure 22.23.

Click on the button labeled **Next** to define the tags and sequence for the reverse reads (figure 22.24).

Click **Next** to specify the output options. First, you can choose to create a list of the reads that could not be grouped. Second, you can create a summary report showing how many reads were found for each barcode. Click **Finish** to perform the demultiplexing.

There is also an option to create subfolders for each sequence list. This can be handy when the

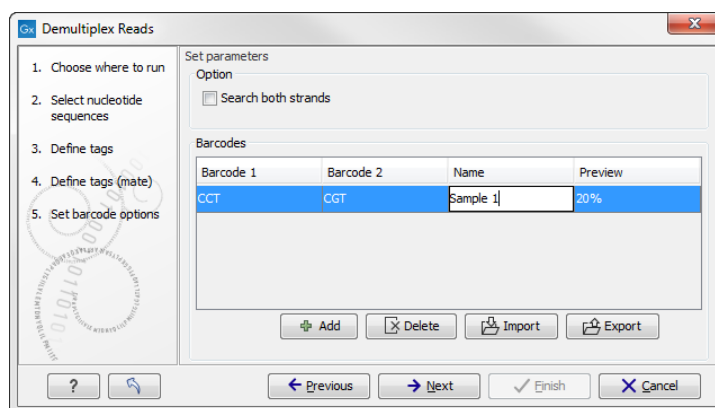

Figure 22.23: The name of the sequence can be renamed by double-clicking on the existing name.



Figure 22.24: Specifying the setup of the reverse read (tags and sequence).

results need to be processed in batch mode (see section 8.3).

A new sequence list will be generated for each barcode containing all the sequences where this barcode is identified. Both the linker and barcode sequences are removed from each of the sequences in the list, so that only the target sequence remains. This means that you can continue the analysis by doing trimming or mapping. Note that you have to perform separate mappings for each sequence list.

An example of the demultiplexing summary report is shown in figure 22.25.

1 Demultiplexing summary

1.1 Reads per barcode

Barcode	Number of reads	Percentage of reads
Barcode:GGT	1,745,043	26%
Barcode:CGT	1,305,703	20%
Barcode:AAT	1,850,050	28%
Barcode:CCT	1,251,849	19%
Not grouped	445,560	7%

1.2 Reads per barcode

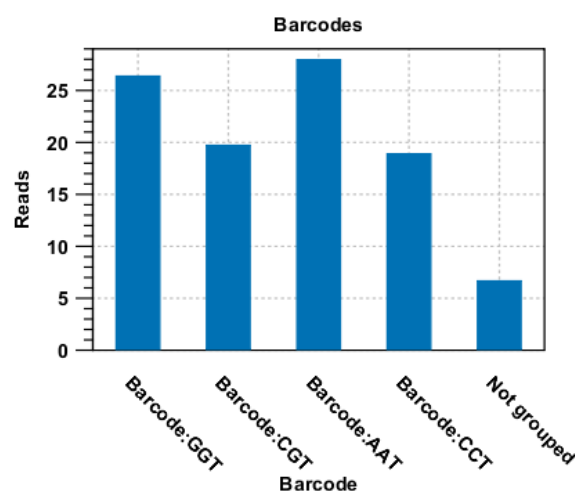

Figure 22.25: An example of a report showing the number of reads in each group. In this example four different barcodes were used to separate four different samples.

An example using Illumina barcoded sequences

The data set in this example can be found at the Short Read Archive at NCBI: <http://www.ncbi.nlm.nih.gov/sra/SRX014012>. It can be downloaded directly in fastq format via the URL http://trace.ncbi.nlm.nih.gov/Traces/sra/sra.cgi?cmd=dload&run_list=SRR030730&format=fastq. The file you download can be imported directly into the Workbench.

The barcoding was done using the following tags at the beginning of each read: CCT, AAT, GGT, CGT (see supplementary material of [Cronn et al., 2008] at <http://nar.oxfordjournals.org/cgi/data/gkn502/DC1/1>).

The settings in the dialog should thus be as shown in figure 22.26.

Click **Next** to specify the bar codes as shown in figure 22.27 (use the **Add** button).

With this data set we got the four groups as expected (shown in figure 22.28). The **Not grouped** list contains 445,560 reads that will have to be discarded since they do not have any of the barcodes.

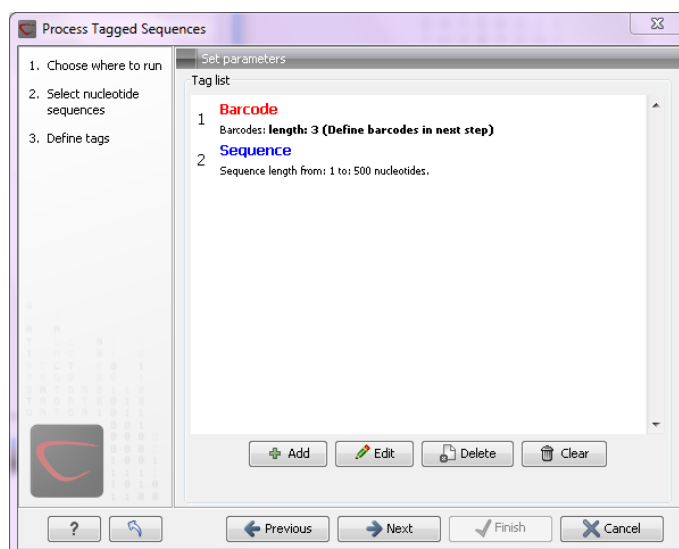

Figure 22.26: Setting the barcode length at three

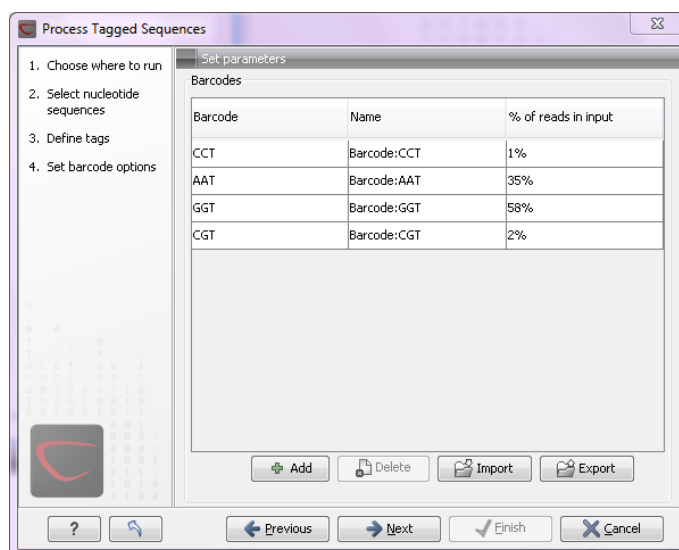

Figure 22.27: A preview of the result

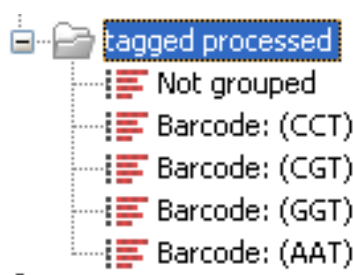

Figure 22.28: The result is one sequence list per barcode and a list with the remainders

22.3 Sequencing data quality control

Quality assurance as well as concern regarding sample authenticity in biotechnology and bioengineering have always been serious topics in both production and research. While next generation sequencing techniques greatly enhance in-depth analyses of DNA-samples, they, however, introduce additional error-sources. Resulting error-signatures can neither be easily removed from

resulting sequencing data nor even recognized, which is mainly due to the massive amount of data. Altogether biologists and sequencing facility technicians face not only issues of minor relevance, e.g. suboptimal library preparation, but also serious incidents, including sample-contamination or even mix-up, ultimately threatening the accuracy of biological conclusions.

Unfortunately, most of the problems and evolving questions raised above can't be solved and answered entirely. However, the sequencing data quality control tool of the *CLC Genomics Workbench* provides various generic tools to assist in the quality control process of the samples by assessing and visualizing statistics on:

- Sequence-read lengths and base-coverages
- Nucleotide-contributions and base-ambiguities
- Quality scores as emitted by the base-caller
- Over-represented sequences and hints suggesting contamination events

This tool aims at assessing above quality-indicators and investigates proper and improper result presentation. The inspiration comes from the FastQC-project (<http://www.bioinformatics.babraham.ac.uk/projects/fastqc/>).

22.3.1 QC Sequencing Report Content

The report comes in two different flavors: a supplementary report consisting of tables representing all the values that are calculated, and a main summary graphical report where the tables are visualized in plots (see an example in figure 22.29). Both reports can be exported as pdf files or Excel spread sheets.

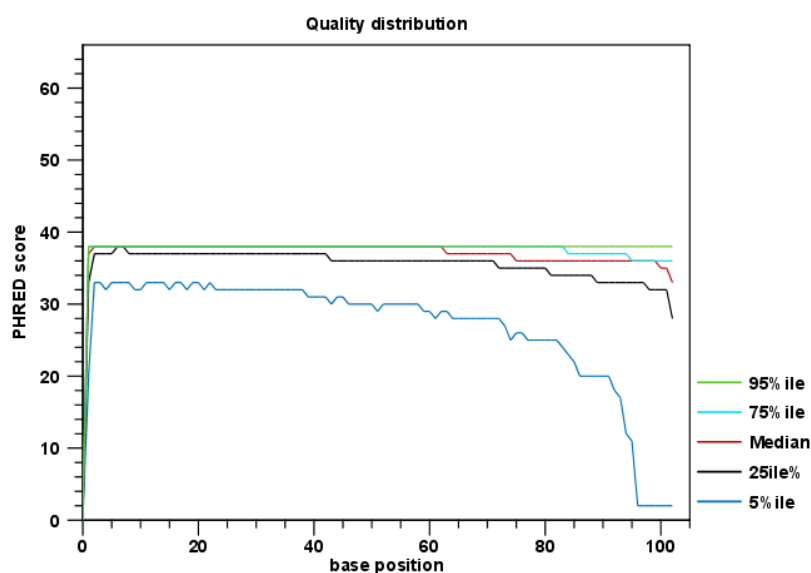

Figure 22.29: An example of a plot from the graphical report, showing the quality values per base position.

The Summary table provides information regarding the creation date, the author, the software used, the number of data sets the report is based upon, as well as data name and content in terms

of read number and total number of nucleotides. The report is then divided in per-sequence and per-base analyses. In the per-sequence analyses, some characteristic (a single value) is assessed for each sequence and then contributes to the overall assessment. In per-base assessments each base position is examined and counted independently. In both sections, the first items assess the most simple characteristics that are supported by all sequencing technologies while the quality analyses examine quality scores reported from technology-dependent base callers. Please note that the NGS import tools of the *CLC Genomics Workbench* and *CLC Genomics Server* convert quality scores to PHRED-scale, regardless of the data source.

Per-sequence analysis

Lengths distribution Counts the number of sequences that have been observed for individual sequence lengths. The resulting table correlates sequence-lengths in base-pairs with numbers of sequences observed with that number of base-pairs. The length distribution depends on your library preparation and sequencing protocol. If you observe secondary peaks at unexpected lengths you may want to consider removing these. Using the Workbench Trim tool you can trim away reads above and/or below a certain length.

GC-content distribution Counts the number of sequences that feature individual %GC-contents in 101 bins ranging from 0 to 100%. The %GC-content of a sequence is calculated by dividing the absolute number of G/C-nucleotides by the length of that sequence, and should look like a normal distribution in the range of what is expected for the genome you are working with. If the GC-content is substantially lower (the normal distribution is shifted to the left), it may be that GC-rich areas have not been properly covered. You can check this by mapping the reads to your reference. A non-normal distribution, or one that has several peaks indicates the presence of contaminants in the reads.

Ambiguous base content Counts the number of sequences that feature individual %N-contents in 101 bins ranging from 0 to 100%, where N refers to all ambiguous base-codes as specified by IUPAC. The %N-content of a sequence is calculated by dividing the absolute number of ambiguous nucleotides through the length of that sequence. This distribution should be as close to 0 as possible.

Quality distribution Calculates the amount of sequences that feature individual PHRED-scores in 64 bins from 0 to 63. The quality score of a sequence as calculated as arithmetic mean of its base qualities. PHRED-scores of 30 and above are considered high quality. If you have many reads with low quality you may want to discuss this with your sequencing provider. Low quality bases/reads can also be trimmed off with the Trim Sequences tool.

Per-base analysis

Coverage Calculates absolute coverages for individual base positions. The resulting graph correlates base-positions with the number of sequences that supported (covered) that position.

Nucleotide contributions Calculates absolute coverages for the four DNA nucleotides (A, C, G or T) for each base position in the sequences. In a random library you would expect little or no difference between the bases, thus the lines in this plot should be parallel to each other. The relative amounts of each base should reflect the overall amount of the bases in your genome. A strong bias along the read length where the lines fluctuate a lot for

certain positions may indicate that an over-represented sequence is contaminating your sequences. However, if this is at the 5' or 3' ends, it will likely be adapters that you can remove using the Trim Sequences tool.

GC-content Calculates absolute coverages of C's + G's for each base position in the sequences. If you see a GC bias with changes at specific base positions along the read length this could indicate that an over-represented sequence is contaminating your library.

Ambiguous base-content Calculates absolute coverages of N's, for each base position in the sequences, where N refers to all ambiguous base-codes as specified by IUPAC.

Quality distribution Calculates the amount of bases that feature individual PHRED-scores in 64 bins from 0 to 63. This results in a three-dimensional table, where dimension 1 refers to the base-position, dimension 2 refers to the quality-score and dimension 3 to amounts of bases observed at that position with that quality score. PHRED-scores above 20 are considered good quality. It is normal to see the quality dropping off near the end of reads. Such low-quality ends can be trimmed off using the Trim Sequences tool.

Over-representation analyses

Enriched 5-mer distribution The 5-mer analysis examines the enrichment of penta-nucleotides. The enrichment of 5-mers is calculated as the ratio of observed and expected 5-mer frequencies. The expected frequency is calculated as product of the empirical nucleotide probabilities that make up the 5-mer. (Example: given the 5-mer = CCCCC and cytosines have been observed to 20% in the examined sequences, the 5-mer expectation is 0.2^5). Note that 5-mers that contain ambiguous bases (anything different from A/T/C/G) are ignored. This analysis calculates the absolute coverage and enrichment for each 5-mer (observed/expected based on background distribution of nucleotides) for each base position, and plots position vs enrichment data for the top five enriched 5-mers (or fewer if less than five enriched 5-mers are present). It will reveal if there is a bias at certain positions along the read length. This may originate from non-trimmed adapter sequences, poly A tails and more.

Sequence duplication levels The duplicated sequences analysis identifies sequence reads that have been sequenced multiple times. A high level of duplication may indicate an enrichment bias, as for instance introduced by PCR amplification. Please note that multiple input sequence lists will be considered as one federated data set for this analysis. Batch mode can be used to generate separate reports for individual sequence lists.

In order to identify duplicate reads the tool examines all reads in the input and uses a clone dictionary containing per clone the read representing the clone and a counter representing the size of the clone. For each input read these steps are followed: (1) check whether the read is already in the dictionary. (2a) if yes, increment the according counter and continue with next read. (2b) if not, put the read in the dictionary and set its counter to 1.

To achieve reasonable performance, the dictionary has a maximum capacity of 250,000 clones. To this end, step 2a involves a random decision as to whether a read is granted entry into the clone dictionary. Every read that is not already in the dictionary has the same chance T of entering the clone dictionary with $T = 250,000 / \text{total amount of input reads}$. This design has the following properties:

- The clone dictionary will ultimately contain at most 250,000 entries.

- The sum of all clone sizes in the dictionary amounts at most to the total number of input reads.
- Because of T being constant for all input reads, even a cluster of reads belonging to the same clone and first occurring towards the end of the input can be detected.
- Because of the random sampling, the tool might underestimate the size of a read clone, specifically if its first read representative does not make it into the dictionary. The ratio is that a larger clone has a higher cumulative chance of being eventually represented in the dictionary than a smaller clone.

Because all current sequencing techniques tend to report decreasing quality scores for the 3' ends of sequences, there is a risk that duplicates are NOT detected, merely because of sequencing errors towards their 3' ends. The identity of two sequence reads is therefore determined based on the identity of the first 50nt from the 5' end.

The results of this analysis are presented in a plot and a corresponding table correlating the clone size (duplication count) with the number of clones of that size. For example, if the input contains 10 sequences and each sequence was seen exactly once, then the table will contain only one row with duplication-count=1 and sequence-count=10. Note: due to space restrictions the corresponding bar-plot shows only bars for duplication-counts of $x=[0-100]$. Bar-heights of duplication-counts >100 are accumulated at $x=100$. Please refer to the table-report for a full list of individual duplication-counts.

Duplicated sequences This results in a list of actual sequences most prevalently observed. The list contains a maximum of 25 (most frequently observed) sequences and is only present in the supplementary report.

22.3.2 Adapters

Currently, adapter contamination, i.e. adapter sequences in the reads, cannot be detected in a reliable way with this tool. In some cases, adapter contamination will show up as enriched 5-mers near the end of sequences but only if the contamination is severe.

22.3.3 Running the quality control tool

The tool is found in the Toolbox:

Toolbox | NGS Core Tools  | **Create Sequencing QC Report** 

Select one or more sequence lists with sequencing reads as input. If sequence lists in the Navigation Area were already selected, these will be shown in the Selected Elements window. When multiple lists are selected as an input, they are all analyzed in one pool. If you need separate reports for each data set, you can run it in a batch. Click **Next** to adjust output options which allow you to select the graphical and supplementary report.

22.4 Merge overlapping pairs

Some paired end library preparation methods using relatively short fragment size will generate data with overlapping pairs. This type of data can be handled as standard paired-end data in the *CLC Genomics Workbench*, and it will work perfectly fine (see details for variant detection in section 25.13).

However, in some situations it can be useful to merge the overlapping pair into one sequence read instead. The benefit is that you get longer reads, and that the quality improves (normally the quality drops towards the end of a read, and by overlapping the ends of two reads, the consensus read now reflects two read ends instead of just one).

In the *CLC Genomics Workbench*, there is a tool for merging overlapping reads, which are in forward-reverse orientation:

Toolbox | NGS Core Tools (📁) | **Merge Overlapping Pairs** (📄)

Select one or more sequence lists with paired end sequencing reads as input.

Please note that read pairs have to be in forward-reverse orientation. Please also note that after merging the merged reads will always be in the forward orientation. As an aside, length trimming of reads can be done before or after merging, however the merged read's 3' is the 5' of the reverse read, so that trimming the original reads using the **Remove 5' terminal nucleotides** option corresponds to trimming the merged reads using both the **Remove 5' terminal nucleotides** option and the **Remove 3' terminal nucleotides** option.

Clicking **Next** allows you to set parameters as displayed in figure 22.30.

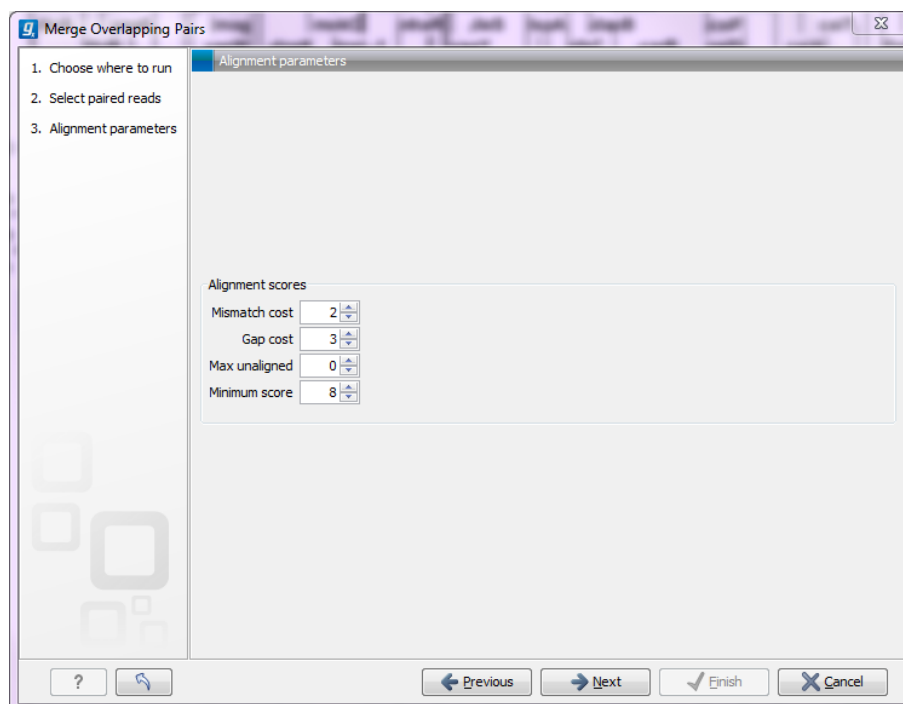

Figure 22.30: Setting parameters for merging overlapping pairs.

In order to understand how these parameters should be set, an explanation of the merging algorithm is needed: Because the fragment size is not an exact number of base pairs and is different from fragment to fragment, an alignment of the two reads has to be performed. If the alignment is *good and long enough*, the reads will be merged. *Good enough* in this context means that the alignment has to satisfy some user-specified score criteria (details below). Because of sequencing errors that typically are more abundant towards the end of the read, the alignment is not expected always to be perfect, and the user can decide how many errors are acceptable. *Long enough* in this context means that the overlap between the reads has to be non-coincidental. Merging two reads that do not really overlap, leads to errors in the downstream analysis, thus it

is very important to make sure that the overlap is big enough. If only a few bases overlap was required, some read pairs will match by chance, so this has to be avoided.

The following parameters are used to define what is *good enough* and *long enough*

- **Mismatch cost** The alignment awards one point for a match, and the mismatch cost is set by this parameter. The default value is 2.
- **Gap cost** This is the cost for introducing an insertion or deletion in the alignment. The default value is 3.
- **Max unaligned end mismatches** The alignment is local, which means that a number of bases can be left unaligned. If the quality of the reads is dropping to be very poor towards the end of the read, and the expected overlap is long enough, it makes sense to allow some unaligned bases at the end. However, this should be used with great care which is why the default value is 0. As explained above, a wrong decision to merge the reads leads to errors in the downstream analysis, so it is better to be conservative and accept fewer merged reads in the result.
- **Minimum score** This is the minimum score of an alignment to be accepted for merging. The default value is 10. As an example: with default settings, this means that an overlap of 13 bases with one mismatch will be accepted (12 matches minus 2 for a mismatch).

Please note that even with the alignment scores above the minimum score specified in the tool setup, the paired reads also need to have the number of end mismatches below the "Maximum unaligned end mismatches" value specified in the tool setup to be qualified for merging.

After clicking **Next** you can select whether a report should be generated as part of the output. The main result will be two sequence lists for each list in the input: one containing the merged reads (marked as single end reads), and one containing the reads that could not be merged (still marked as paired data). Since the *CLC Genomics Workbench* handles a mix of paired and unpaired data, both of these sequence lists can be used in the further analysis. However, please note that low quality can be one of the reasons why a pair cannot be merged. Hence, the list of reads that could not be paired is more likely to contain more reads with errors than the one with the merged reads.

22.4.1 Using quality scores when merging

Quality scores come into play in two different ways when merging overlapping pairs.

First, if there is a conflict between the reads in a pair (i.e. a mismatch or gap in the alignment), quality scores are used to determine which base the merged read should have at a given position. The base with the highest quality score will be the one used. In the case of gaps, the average of the quality scores of the two surrounding bases will be used. In the case that two conflicting bases have the same quality or both reads have no quality scores, an [IUPAC ambiguity code](see the appendix section H) representing these bases will be inserted.

Second, the quality scores of the merged read reflect the quality scores of the input reads.

We assume independence of errors in calculating the new quality score for a merged position and carry out the following calculations:

- When the two reads agree at a position, the two quality scores are summed to form the quality score of the base in the new read. The score is capped at the maximum value on the quality score scale which is 64. Phred scores are log scores, so their sums represent the multiplication of the original error probabilities.
- If the two bases disagree at a position, the quality score of the base in the new read is determined by subtracting the lowest score from the highest score of the input reads. Similar to the addition of scores when bases are the same, this adjusts the error probability to reflect a decreased certainty that the base reported at that position is correct.

Thus, if two bases at a given position of an overlapping region are different, and each of those bases was originally given a high phred score, the score assigned to the merged base will be very low. This reflects the fact that the base at this position is unreliable.

If a base at a given position in one read of an overlapping region has a very low quality score and the base at that position in the other read has a high score, it is likely that the base with the high quality score is correct. The adjusted quality score for this position in the merged read would reflect that there is less certainty in the base at that position than before. However, such a position would still be assigned quite a high quality, as the base call is still likely to be correct.

22.4.2 Report of merged pairs

Figure 22.31 shows an example of the report generated when merging overlapping pairs.

It contains three sections:

- A summary showing the numbers and percentages of reads that have been merged.
- A plot of the alignment scores. This can be used to guide the choice of minimum alignment score as explained in section 22.4.
- A plot of read lengths. This shows the distribution of read lengths for the pairs that have been merged:
 - The length of the overlap.
 - The length of the merged read.
 - The combined length of the two reads in the pair before merging.

1 Summary

	Number of reads	Percentage
Merged	20,105,092	44.53%
Not merged	25,044,608	55.47%
Total	45,149,700	100%

2 Alignment score distribution

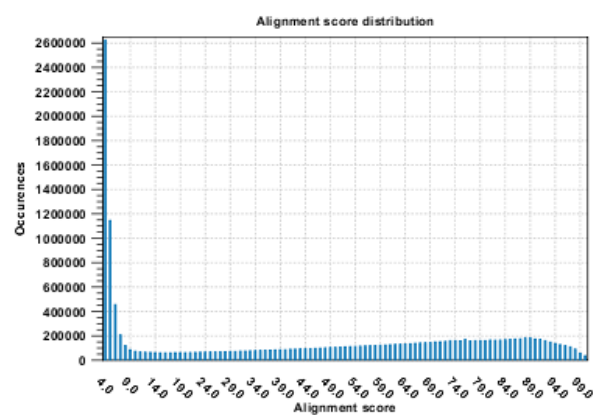

3 Length distribution

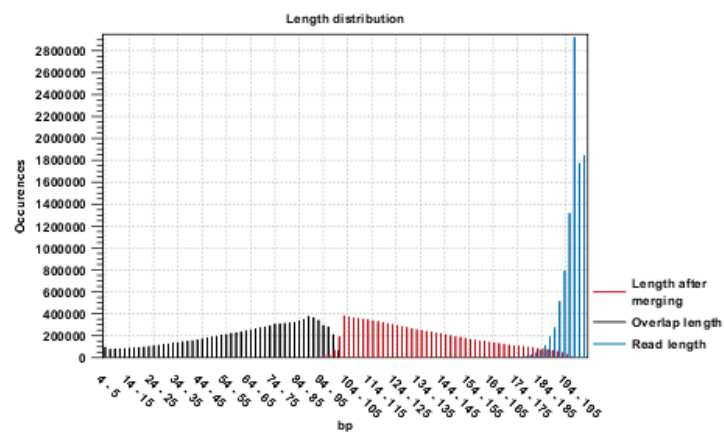

Figure 22.31: Report of overlapping pairs.

Chapter 23

Tracks

Contents

23.1 Track lists	576
23.1.1 Zooming and navigating track views	578
23.1.2 Adding, removing and reordering tracks	578
23.1.3 Showing a track in a table	579
23.1.4 Open track from a track list in table view	579
23.1.5 Finding annotations on the genome	580
23.1.6 Extract sequences from tracks	581
23.1.7 Creating track lists in workflows	584
23.2 Retrieving reference data tracks	585
23.3 Merging tracks	585
23.4 Converting data to tracks and back	585
23.4.1 Convert to tracks	586
23.4.2 Convert from tracks	586
23.5 Annotate and filter tracks	589
23.5.1 Annotate with overlap information	589
23.5.2 Extract reads based on overlap	589
23.5.3 Filter annotations on name	592
23.5.4 Filter Based on Overlap	592
23.6 Filter Based on Overlap	593
23.7 Graphs	593
23.7.1 Create GC Content Graph	594
23.7.2 Create Mapping Graph	595
23.7.3 Identify Graph Threshold Areas	598

This chapter explains how to visualize tracks, how to retrieve reference data and finally how to perform generic comparisons between tracks.

A track is the fundamental building block for NGS analysis in the *CLC Genomics Workbench*. The idea behind tracks is to provide a unified framework for the visualization, comparison and

analysis of genome-scale studies such as whole-genome sequencing or exome resequencing projects and a variety of different -Seq data (i.e. RNA-seq, ChIP-Seq, DNase-Seq).¹

In tracks, all information is tied to genomic positions. A central coordinate-system is provided by a reference genome, which allows that different types of data or results for different samples can be seen and analyzed together.

Different types of data are represented in different types of tracks, and each type of track has its own particular editors. An example of a paired-end mapping read-track displaying reads and coverage is shown in figure 23.1.

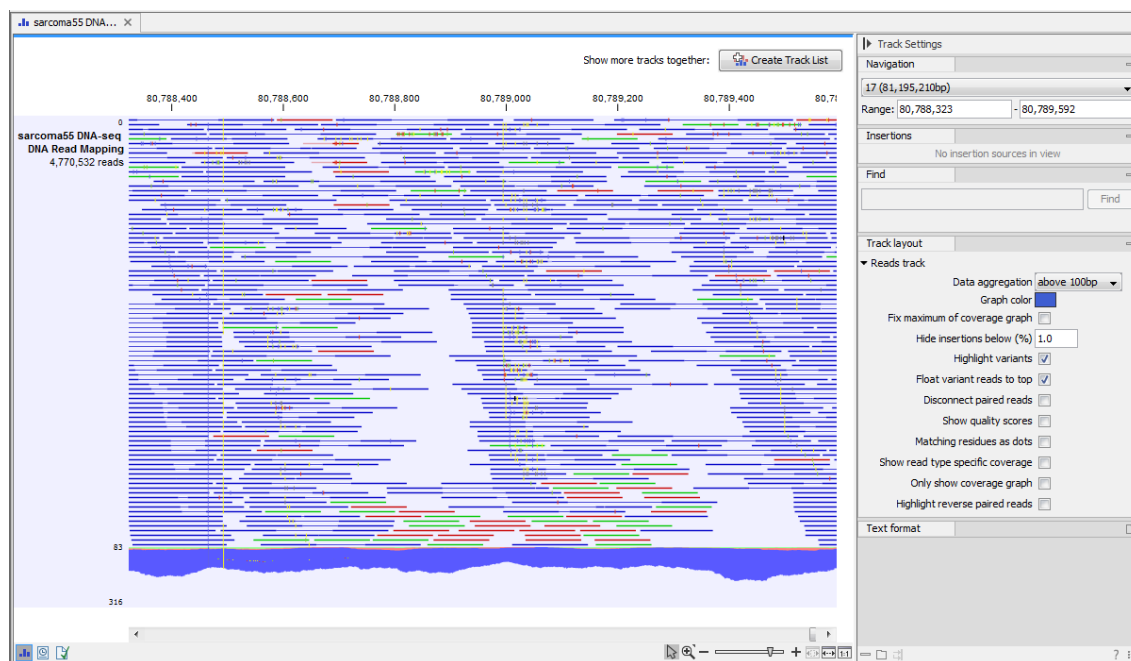

Figure 23.1: A paired-end mapping read-track opened, displaying reads and coverage. On the top right, the button for creating a Track List is visible. On the right is the SidePanel.

The different track types in the CLC Genomics Workbench are:

A sequence (☒) This is the track type that is used for holding the reference genome. The sequence track contains the single reference sequences of the genome (e.g. the chromosomes or the consensus sequences of de novo assembled contigs).

A reads track (☒) This is the track type that is used for holding a read mapping e.g. as produced by the Map Reads to Reference (see section 24.1), Local Realignment (see section 24.5) or RNA-Seq Analysis (see section 26.1) tools. The reads track contains all the reads that have been mapped at their mapped positions, and you can zoom in all the way to base resolution. In case there are more reads than the height of the track allows, an overflow graph will be displayed below the reads in the same colors than the reads that it represents.

A variant track (☒) A variant track is a particular kind of track that is used to store features that fulfill the requirements for being a variant. A particular requirement for being a variant

¹The track concept was first introduced with the Genomics Gateway plugin in 2011 and made an integral part of the CLC Genomics Workbench 5.5 release.

is that it refers to a particular region of the reference, and it is possible to describe exactly how the sample "Allele" sequence looks in this region, as compared to what the "reference allele" sequence looks like in this region. Variants may be of type SNV, MNV, replacement, insertion or deletion. A variant track may be produced either by running a Variant detection analysis (e.g using a variant caller or by importing a variant format file (such as a "vcf" or a "gvf" file) or downloading it from a database (e.g. dbSNP). The tool InDels and Structural Variants (see section 25.2) detects structural variants, including insertions, deletions, inversions, translocations and tandem duplications. It will produce a variant track, which will contain some insertions and deletions (the "InDel" track). However, the tool will also detect some insertions for which the "Allele" sequence is not fully, but only partially, known. These insertions do not fulfill the requirements of being a variant and therefore cannot be put in the variant track. Instead they are put in the "SV track", along with the inversions and translocations. The "SV" track is an "annotation" (or "feature") track, which is less strict and more flexible, in the requirements to the types of annotations (or features) that it can contain (see below).

An annotation track  Each annotation track contains a certain type of annotations. Examples are gene or mRNA tracks, which contain gene, respectively mRNA, annotations, UTR tracks, conservation score tracks and target region tracks. They may be obtained either by importing (see section 6.2 or downloading them into the Workbench (e.g from a .bed, .gtf or .gff file or a database, such as ENSEMBL). Also, many of the tools in the *CLC Genomics Workbench* will output annotation tracks. Examples are the InDels and Structural Variants tool, which will put the detected structural variants (that do not fulfill the requirements for being of type "variant") in an annotation track, or the ChIP-Seq detection tool which will put the detected "peaks" into a "peak" annotation track. A description of how to annotate and filter tracks is found in section 23.5.

A coverage graph  The coverage graph track is calculated from a reads track and contains a graphical display of the coverage at each position in the reference.

An expression track  The RNA-seq algorithm produces expression tracks: one for genes and one for transcripts. These have an annotation for each gene or transcript, and an expression value associated to that annotation. The type of expression value associated with each annotation is determined by the expression value parameter selected in the RNA-Seq tool. These values are visualized as a color gradient from blue to red; the lowest expression value within each chromosome of the track is represented as 0% and the highest expression value within each chromosome of the track is represented by 100%.

An example of the different types of tracks is given in figure 23.2.

For comparison tools specific to resequencing and variants, please see chapter 25.

23.1 Track lists

For details on how to find and import different tracks see section 6.2. Tracks are saved as files in the **Navigation Area** with specific icons representing each track type, e.g. an annotation track .

To visualize several tracks together, they can be combined into a **Track List** . Track lists can be created in different ways. One way is via the menu bar:

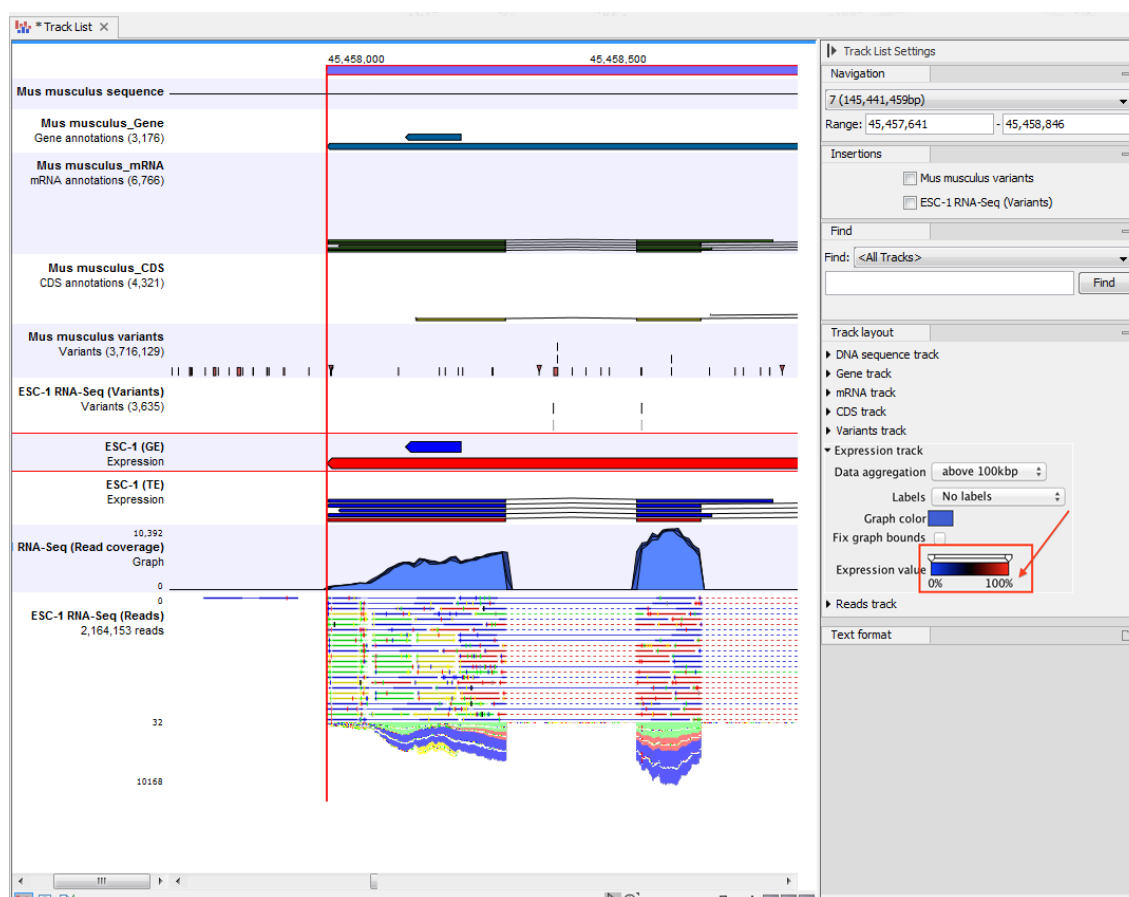

Figure 23.2: A tracklist containing different types of tracks. From the top: a sequence track, three annotation tracks with gene, mRNA and CDS annotations respectively, two variant tracks, a gene-level (GE) and a transcript level (TE) expression track, a coverage track and a reads track.

File | New | Track List (📊)

Another way is to use the Track Tool **Create Track List** (📊). Finally, tracks can be created directly using the button labeled **Create Track List** that is found in the top right corner of the open track in the view area. Figure 23.3 shows an example of a track list including a track with mapped reads at the top, followed by a variant detection track, and in the lower part of the figure, the reference sequence with CDS annotations.

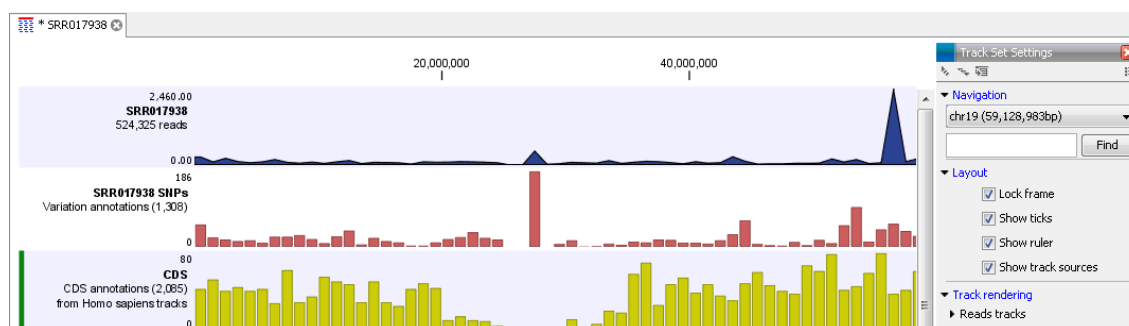

Figure 23.3: Three tracks shown in the track list view

The track list is designed to be used as a container for multiple tracks for easy visualization

and comparative analysis. Therefore all the involved tracks and the track list are required to be present and located in one single location (Workbench or CLC Server). Otherwise, they will be marked as "Unresolved track" in the track list.

23.1.1 Zooming and navigating track views

It is possible to zoom in and out with the zoom tools in the lower right-hand corner of the View Area, or by using a mouse scroll wheel while pressing the Ctrl (⌘ on Mac) key. If you want to zoom in to 100 % to see the data at base level, click the **Zoom to base level** (1:1) icon.

If you want to zoom out to see all the data, click the **Zoom to Fit** (↔) icon. When zooming out you will see that the data is visualized in an aggregated format using a density bar plot or a graph.

23.1.2 Adding, removing and reordering tracks

You can organize your tracks by dragging them up and down. Right-clicking on any of the tracks opens up a context menu with several options (Figure 23.4). The options shown in the context menu will vary depending on which tracks you have open in the viewing area. Hence, you may not be presented with all the options described here.

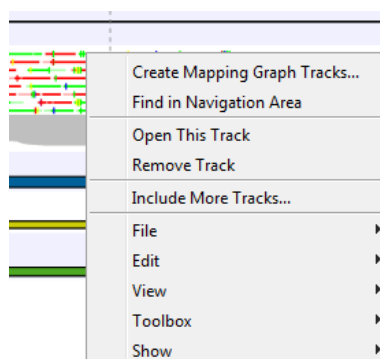

Figure 23.4: Options to handle and organize tracks.

Create Mapping Graph Tracks This will allow you to create a new track from a mapping track (learn more in section 23.7).

Find in Navigation Area This will select the track in the **Navigation Area**.

Open This Track This opens a new view of the track. For annotation and variant tracks, a table view is opened as described in section 23.1.3. This can also be accomplished by double-clicking the track.

Remove Track This will remove the track from the current view. You can add it again by dragging it from the **Navigation Area** into the track list view or by pressing **Undo** (↶).

Include More Tracks This will allow you to add other track sets to your current track set. Please note that the information in the track will still be stored in its original track set. This means that you by including a track in this way at the same time is adding a reference to this track in another track set. An example of this could be the inclusion of a SNP track from another sample to your current analysis.

23.1.3 Showing a track in a table

All tracks containing annotations (including variants) can be opened in a table. From the track list (see section 23.1) this is done either by double-clicking the label of the track or by right-clicking the track and choosing **Open This Track**. Alternatively, you can open the track from the **Navigation Area** and switch to the table view () at the bottom.

The table will have one row for each annotation, and the columns will reflect its information content. Figure 23.5 shows an example of a variant database track that is presented in a table.

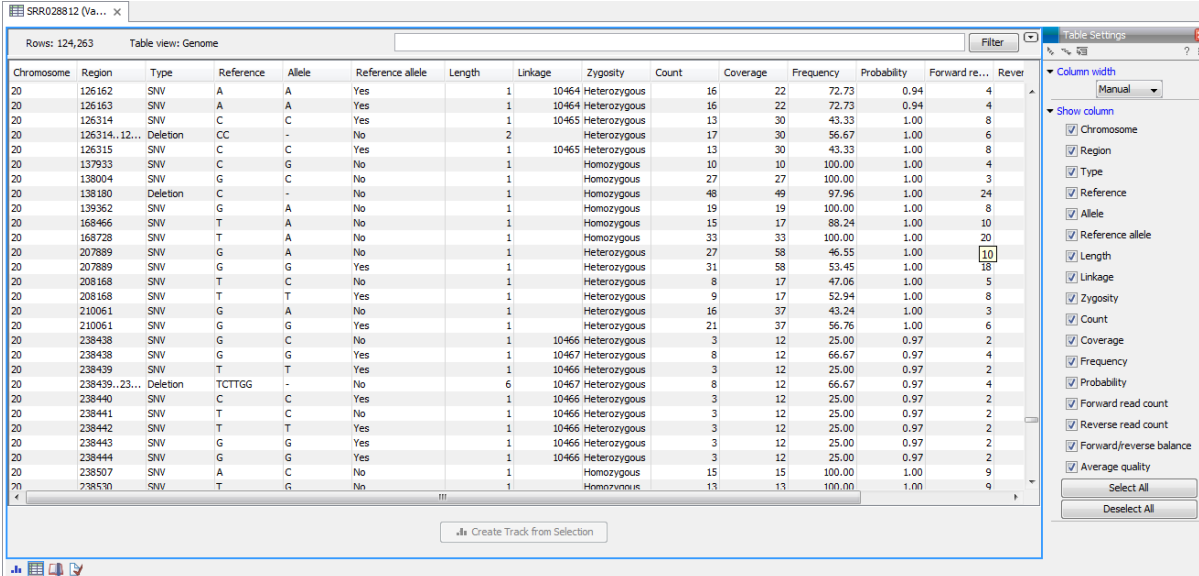

Chromosome	Region	Type	Reference	Allele	Reference allele	Length	Linkage	Zygosity	Count	Coverage	Frequency	Probability	Forward re...	Rever
20	126162	SNV	A	A	Yes	1	10464	Heterozygous	16	22	72.73	0.94	4	4
20	126163	SNV	A	A	Yes	1	10464	Heterozygous	16	22	72.73	0.94	4	4
20	126314	SNV	C	C	Yes	1	10465	Heterozygous	13	30	43.33	1.00	8	8
20	126314..12...	Deletion	CC	-	No	2		Heterozygous	17	30	56.57	1.00	6	6
20	126315	SNV	C	C	Yes	1	10465	Heterozygous	13	30	43.33	1.00	8	8
20	137933	SNV	C	G	No	1		Homozygous	10	10	100.00	1.00	4	4
20	139004	SNV	G	C	No	1		Homozygous	27	27	100.00	1.00	3	3
20	138180	Deletion	C	-	No	1		Homozygous	48	49	97.96	1.00	24	24
20	139362	SNV	G	A	No	1		Homozygous	19	19	100.00	1.00	8	8
20	168466	SNV	T	A	No	1		Homozygous	15	17	88.24	1.00	10	10
20	168728	SNV	T	A	No	1		Homozygous	33	33	100.00	1.00	20	20
20	207889	SNV	G	A	No	1		Heterozygous	27	58	46.55	1.00	10	10
20	207889	SNV	G	G	Yes	1		Heterozygous	31	58	53.45	1.00	18	18
20	208168	SNV	T	C	No	1		Heterozygous	8	17	47.06	1.00	5	5
20	208168	SNV	T	T	Yes	1		Heterozygous	9	17	52.94	1.00	8	8
20	210061	SNV	G	A	No	1		Heterozygous	16	37	43.24	1.00	3	3
20	210061	SNV	G	G	Yes	1		Heterozygous	21	37	56.76	1.00	6	6
20	238438	SNV	G	C	No	1	10466	Heterozygous	3	12	25.00	0.97	2	2
20	238438	SNV	G	G	Yes	1	10467	Heterozygous	8	12	66.67	0.97	4	4
20	238439	SNV	T	Yes	1	10466	Heterozygous	3	12	25.00	0.97	2	2	
20	238439..23...	Deletion	TCTTGG	-	No	6	10467	Heterozygous	8	12	66.67	0.97	4	4
20	238440	SNV	C	C	Yes	1	10466	Heterozygous	3	12	25.00	0.97	2	2
20	238441	SNV	T	C	No	1	10466	Heterozygous	3	12	25.00	0.97	2	2
20	238442	SNV	T	T	Yes	1	10466	Heterozygous	3	12	25.00	0.97	2	2
20	238443	SNV	G	G	Yes	1	10466	Heterozygous	3	12	25.00	0.97	2	2
20	238444	SNV	G	G	Yes	1	10466	Heterozygous	3	12	25.00	0.97	2	2
20	238507	SNV	A	C	No	1		Homozygous	15	15	100.00	1.00	9	9
20	238508	SNV	T	G	No	1		Homozygous	13	13	100.00	1.00	9	9

Figure 23.5: Showing a variant track in a table view.

You can use the table to sort, filter and select annotations (see Appendix 3.3). Please note that there are two additional options for *filtering on overlaps* in the "Region" column

When selecting a row in the table the graphical view will jump to this position on the genome. Please note that table filtering only affects the table. The track itself remains unaffected and keeps all annotations. If you also wish to filter tracks in the graphical view, the **Annotate and Filter** tools can be used instead.

At the bottom of the table a button labeled **Create Track from Selection** is available. This function can be used to create tracks showing only a subset of the data and annotations. Select the relevant rows in the table and click the button to create a new track that only includes the selected subset of the annotations. This function is particularly useful when used in combination with the filter.

23.1.4 Open track from a track list in table view

To open a table view of a track that is part of a track list, open the track list by double-clicking on the track name in the **Navigation Area**. The track will open in a graphical view. To open a single track from the track list in table view, either right-click on the track and choose "Open This Track" (see figure 23.6) or double-click on the name of the track you would like to open in table view (in the left side of the track when it is open in the **View Area**. This will automatically open

op the specific track in table view.

The screenshot shows a genomic browser interface. At the top, there are several tracks: bSNP135Common.gtf_Exon, NC_000017 (Genome), bSNP135Common.gtf_Gene, and 135Common.gtf_Transcript. A right-click context menu is open over the bSNP135Common.gtf_Gene track, with 'Open This Track' highlighted. A red arrow points to the 'Open This Track' option, and another red arrow points to the 'Open This Table' option. Below the tracks, there is a table view showing genomic data. The table has columns for Chromosome, Region, Name, score, source, gene_id, and transcript_id. The table contains several rows of data, including entries for NC_000017 and various gene transcripts. A tooltip for the BRCA2 gene is visible, showing details such as /gene="BRCA2", /note="Derived by automated computational analysis using gene prediction method: BestRefseq.", /db_xref="GeneID:675", /db_xref="HGNC:1101", and /db_xref="MIM:600185".

Figure 23.6: One way to open a table view of a track that is part of a track list is to right click on the track of interest and select "Open This Table".

23.1.5 Finding annotations on the genome

In the **Side Panel** under **Find**, a search field allows you to quickly find the annotation that you are looking for. The list of tracks further allows you to restrict the search to a particular track (e.g. a gene track).

In the search field you can enter any kind of text that exists in the annotation track. As an example, consider the gene and tool tip shown in figure 23.7.

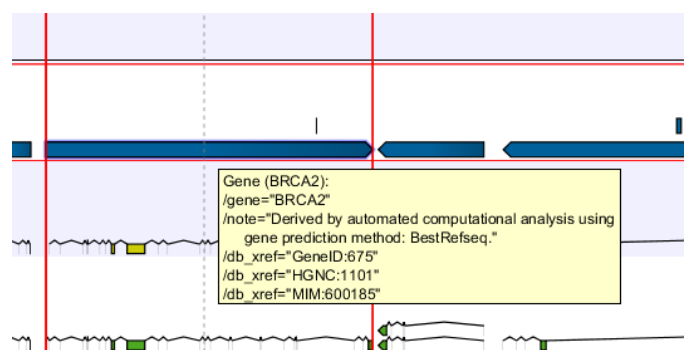

Figure 23.7: The BRCA2 gene.

This gene could be found by searching for the name specifically or, by using a wildcards (asterisks), less specific search terms could be use, giving more flexibility. To find BRCA2, for

example, any of the following entries could be typed in the search field:

BRCA2 This would match the annotation name exactly.

BRCA* This would match the annotation name as well as other genes with a text starting with BRCA (e.g. the BRCA1 gene).

***RCA2** This would match the annotation name as well as other genes with a text ending with RCA2 (e.g. the SMARCA2 gene).

600185 This would match the `db_xref` qualifier for the OMIM database. All the text shown for the annotation in figure 23.7 can be searched this way, both as exact matches and with the * before or after the search term.

Just below the search field in the **Side Panel**, a status label informs about the progress of the search and the hit that has been found. Placing the mouse on top of the label will display a tool tip with more info (see 23.8).

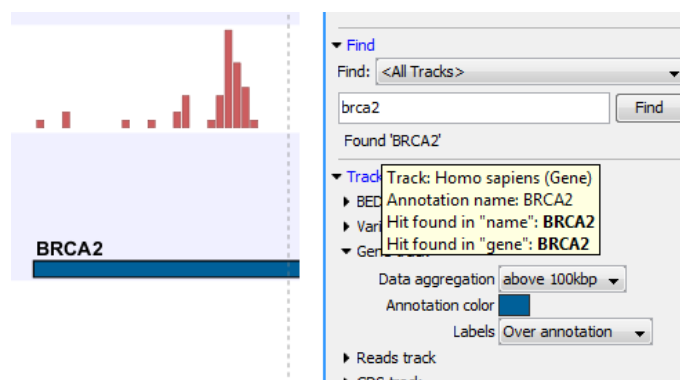

Figure 23.8: *The BRCA2 gene found.*

The search will be performed throughout the entire genome beginning with the chromosome currently shown and stopping when it finds the first hit. Press **Find** again to find the next hit. Once the whole genome has been traversed, the status will inform you that you have searched the whole genome. Click the **Find** button to start the search again.

Please note that you can also use the table view of an annotation track to perform more advanced queries of the data (see section 23.1.3).

23.1.6 Extract sequences from tracks

Like for all other sequence lists (see section 13.2), it is possible to extract sequences from tracks. The sequence of interest can be selected by dragging the mouse over the region of interest followed by a right click on the reads and a click on **Extract sequences** (figure 23.9).

This opens up the dialog shown in figure 23.10 that allows specification of whether the selected sequences should be extracted as single sequences or as a list of sequences.

Right clicking on the reads also enable the option **Extract from selection**, a function that corresponds to the **Extract from selection** described in section 17.7.6 although with small differences. Common for both versions of the **Extract from selection** function is that when extracting reads in an interval, only reads that are completely covered by the selection will be

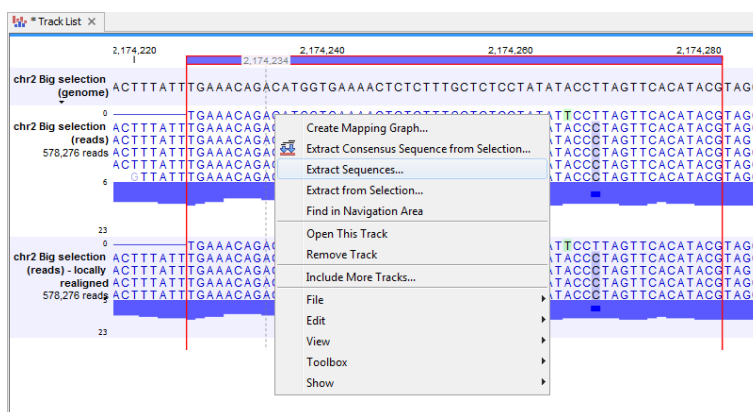

Figure 23.9: Extract sequences from tracks.

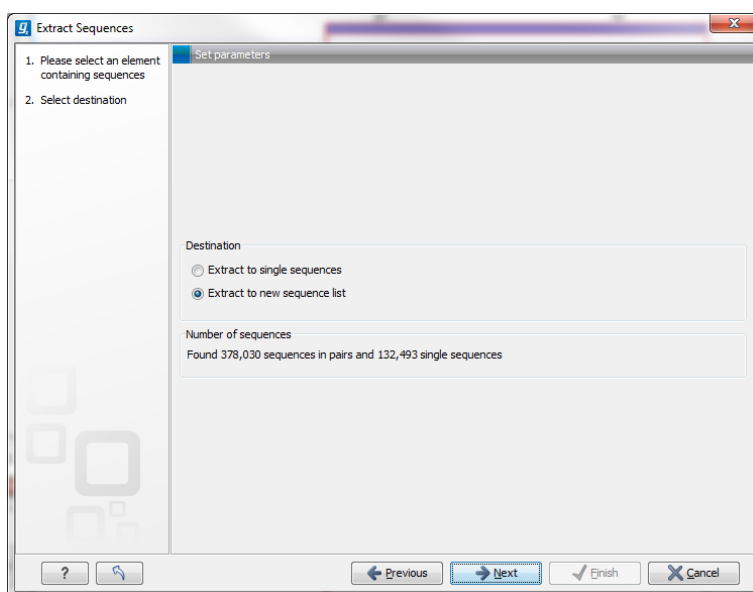

Figure 23.10: Select destination for extracted sequences.

part of the extracted sequence, which in turn means that the tool can be used to extract only a subset of reads.

Clicking **Extract from selection** opens up the dialog shown in figure 23.11.

The purpose of this dialog is to let you specify which kinds of reads you wish to include. Per default all reads are included.

The options are:

Interval

Only include reads contained within the intervals Only reads that are included within the selection will be extracted. Reads that continue outside the selected area are not included.

Paired status

Include intact paired reads When paired reads are placed within the paired distance specified, they will fall into this category. Per default, these reads are colored in blue.

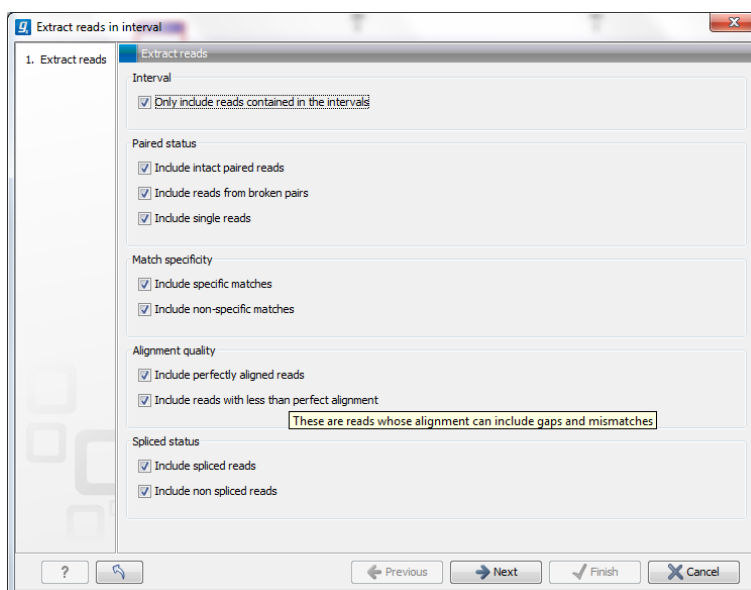

Figure 23.11: Select the reads to include.

Include paired reads from broken pairs When a pair is broken, either because only one read in the pair matches, or because the distance or relative orientation is wrong, the reads are placed and colored as single reads, but you can still extract them by checking this box.

Include single reads This will include reads that are marked as single reads (as opposed to paired reads). Note that paired reads that have been broken during assembly are not included in this category. Single reads that come from trimming paired sequence lists are included in this category.

Match specificity

Include specific matches Reads that only are mapped to one position.

Include non-specific matches Reads that have multiple equally good alignments to the reference. These reads are colored yellow per default.

Alignment quality

Include perfectly aligned reads Reads where *the full read* is perfectly aligned to the reference sequence (or consensus sequence for de novo assemblies). Note that at the end of the contig, reads may extend beyond the contig (this is not visible unless you make a selection on the read and observe the position numbering in the status bar). Such reads are not considered perfectly aligned reads because they don't align in their entire length.

Include reads with less than perfect alignment Reads with mismatches, insertions or deletions, or with unaligned nucleotides at the ends (the faded part of a read).

Spliced status

Include spliced reads Reads that are across an intron.

Include non spliced reads Reads that are not across an intron.

23.1.7 Creating track lists in workflows

Track lists can be created as part of workflows. Track lists are different from all other workflow outputs in the sense that the tracks inside the track lists have to be saved separately, even if they are included in a track list.

Figure 23.12 shows an example where two tracks are fed into the **Create Track List** element.

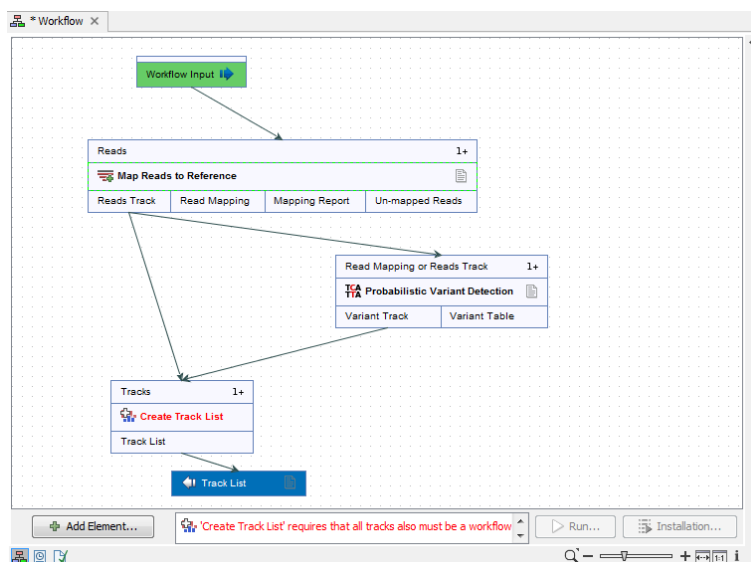

Figure 23.12: This workflow does not work because the two tracks need to be marked as output.

In this example, there is a warning at the bottom of the editor pointing at the fact that these two tracks need to be selected as output in order for the workflow to be validated. In figure 23.13, this has been corrected by selecting the tracks as output, and the workflow can now be executed.

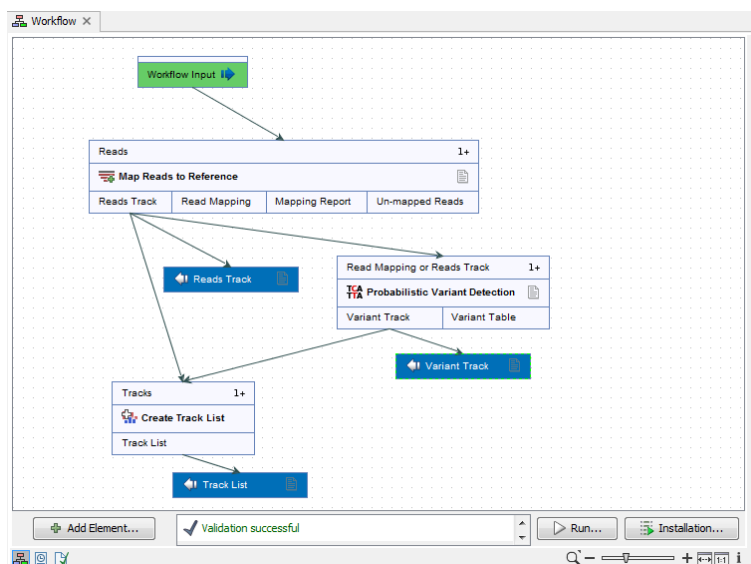



Figure 23.13: The tracks have been selected as output, and the workflow can now be executed.

23.2 Retrieving reference data tracks

For most applications (except de novo sequencing), you will need reference data in the form of a reference genome sequence, annotations, known variants etc. There are three basic ways of obtaining reference data tracks:

1. Use the integrated tool for downloading reference genomes as tracks (see section 7.1).
2. Import tracks from files (learn more in section 6.2).
3. Convert sequences with annotations to tracks (learn more in section 23.4). Sequences can come from a variety of sources:

Standard Import () The standard import accepts common data formats like fasta, genbank etc. (learn more in section 6)

Downloading from NCBI The integrated tool for searching and downloading data from NCBI (learn more in section 7.2).

Contigs created from de novo assembly. Contig sequences from de novo assembly (see section 28.1) can be considered a reference genome for e.g. subsequent resequencing analysis applications.

Please note that tracks are not yet supported with all transcriptomics tools of *CLC Genomics Workbench*. In this case, you have to provide standard sequences (downloading from NCBI or importing files).

23.3 Merging tracks

Two tracks can be merged using the **Merge Annotation Tracks** tool:

Toolbox | Track Tools () | **Merge Annotation Tracks**

Select two or more tracks to be merged. The tracks have to be of the same type, e.g. gene tracks, and be based on the same genome.

Click **Next** and **Finish** to merge the tracks.

If the same annotation is found in both tracks, it is merged into one. If the two annotations share the same region (i.e. same coordinates), they are merged. Information from both annotations are retained in the output. Annotations are merged even when their names differ. Which name is being kept is entirely based on the order of the input tracks as the name being kept is derived from the track that was selected first in the **Merge Read Mappings** wizard. An extra column labeled **Origin tracks** is added to the resulting track indicating which track the annotation originates from. The Merging Annotation Tracks tool is useful when merging gene tracks from different sources using different naming conventions.

Please note that this tool is not well-suited for comparing tracks (see section 25.15 instead).





23.4 Converting data to tracks and back

The *CLC Genomics Workbench* provides tools for converting data to tracks, for extracting sequences and annotations from tracks, and for creating standard annotated sequences and mappings.

23.4.1 Convert to tracks

When working with tracks, information from standard sequences and mappings are split into specialized tracks with sequence, annotations and reads. This tool creates a number of tracks based on the input sequences:

Toolbox | Track Tools | Convert to Tracks

The following kinds of data can be converted to tracks: nucleotide sequences () , sequence lists () , read mappings () / () , and the mapping and annotation information from RNA-Seq results () . Select the input and click **Next** to specify which tracks should be created (see figure 23.14).

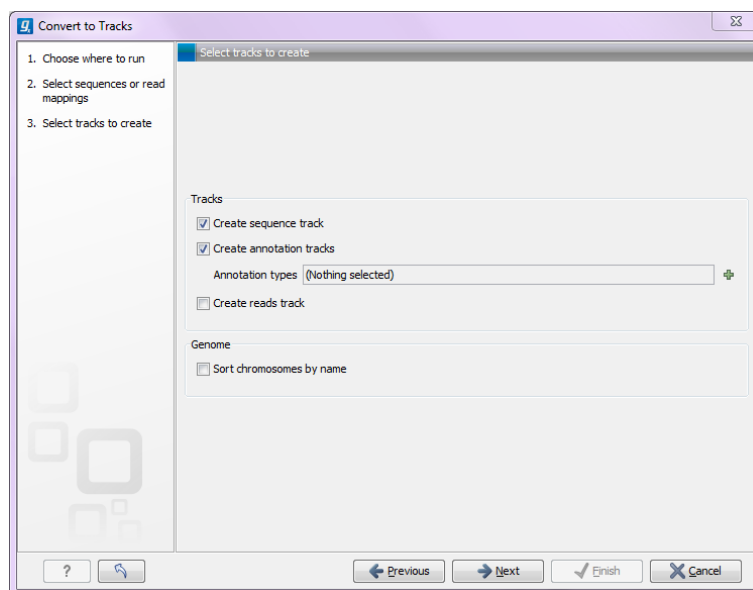

Figure 23.14: Converting data to tracks.

For sequences and sequence lists, you can **Create a sequence track** (for mappings, this will be the reference sequence) and a number of **Annotation tracks**. For each annotation type selected, a track will be created. For mappings, a **Reads track** can be created as well.

At the bottom of the dialog, there is an option to sort sequences by name. This is useful for example to order chromosomes in the menus etc (chr1, chr2, etc). Alphanumerical sorting is used to ensure that the part of the name consisting of numbers is sorted numerically (to avoid e.g. chr10 getting in front of chr2). When working with de novo assemblies with huge numbers of contigs, this option will require additional memory and computation time.

23.4.2 Convert from tracks

Tracks are useful for comparative analysis and visualization, but sometimes it is necessary to convert a track to a normal sequence or mapping. This can be done with the **Convert from Tracks** tool that can be found here:

Toolbox | Track Tools | Convert from Tracks

One or more tracks can be used as input. In the example given in figure 23.15 a reads track and two annotation tracks are converted simultaneously to an annotated read mapping (figure 23.16).

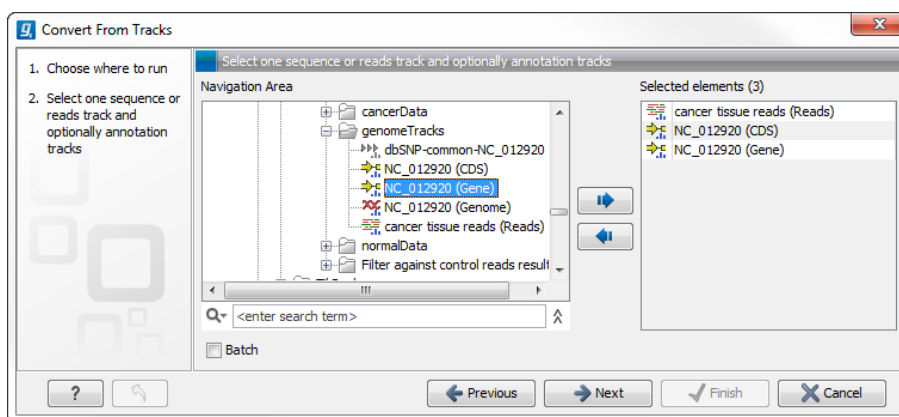

Figure 23.15: A reads track and two annotation tracks are converted from track format to stand alone format.



Figure 23.16: The upper part of the figure shows the three input tracks. For simplicity the three individual tracks are shown in a track list. The lower part of the figure shows the resulting stand alone annotated read mapping.

Likewise it is possible to create an annotated, stand-alone reference from a reference track and the desired number of annotation tracks. This is shown in figure 23.17 where one reference and two annotation tracks are used as input.

The output is shown in figure 23.18. The reference sequence has been transformed to stand alone format with the two annotations "CDS" and "Gene".

Depending on the input provided, the tool will create one of the following types of output:

Sequence (☒) Will be created when a sequence track (☒) with a genome with only one sequence (one chromosome) is provided as input

Sequence list (☒) Will be created when a sequence track (☒) with a genome with several sequences (several chromosomes) is provided as input

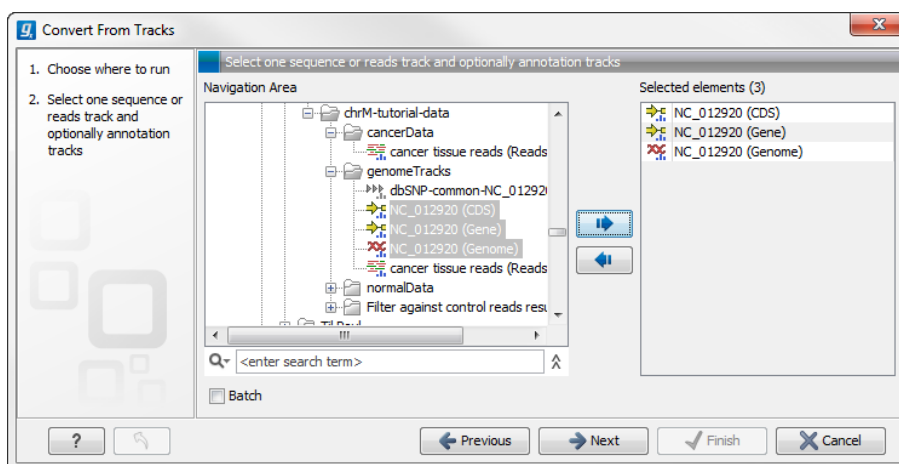

Figure 23.17: A reference track and two annotation tracks are converted from track format to stand alone format.



Figure 23.18: The upper part of the figure shows the three input tracks. For simplicity the three individual tracks are shown in a track list. The lower part of the figure shows the resulting stand alone annotated reference sequence.

Mapping (≡) Will be created when a reads track (≡) with a genome with only one sequence (one chromosome) is provided as input.

Mapping table (≡) Will be created when a reads track (≡) with a genome with several sequences (several chromosomes) is provided as input.

In all cases, any number of annotation tracks (→) / (→) can be provided, and the annotations will be added to the sequences (reference sequence for mappings) as shown in figure 23.16.

23.5 Annotate and filter tracks

One of the big advantages of using tracks is that tracks support comparative analysis between different kinds of data. This section describes generic tools for annotating and filtering tracks (for filtering and annotating variants, please refer to chapter 25).

23.5.1 Annotate with overlap information

This will create a copy of the track used as input and add information from overlapping annotations or variants:

Toolbox | Track Tools (📊) | Annotate and Filter | Annotate with Overlap Information

First, select the track you wish to annotate and click **Next**. You can choose any kind of annotation track as input. Next, select the variant track for overlap comparison.

The result of this tool is a new track with all the annotations from the input track and with additional information from the annotations that overlap from the other track. The requirement for being registered as an overlap is that parts of the annotations are overlapping, regardless of the strandedness of the annotations (note that this makes it unsuitable for comparing e.g. two gene tracks but great for annotating variants with overlapping genes or regulatory regions).

When running the "Annotate with overlap information" tool with a gene track as input and a variant track as parameter track, a new column describing the specific variant is added to the Track Table. The variant description also appears in the track tooltips when mousing over the individual variants.

23.5.2 Extract reads based on overlap

This tool can be used to extract subsets of reads based on annotations. When extracting reads with a specific annotation, the annotation will function as a tag pulling out all the reads with the overlapping annotation (or, when handling paired read data, all the pairs of reads). To launch the tool, go to:

Toolbox | Track Tools (📊) | Annotate and Filter | Extract Reads Based on Overlap (👉)

Read mapping tracks can be used as input (figure 23.19).

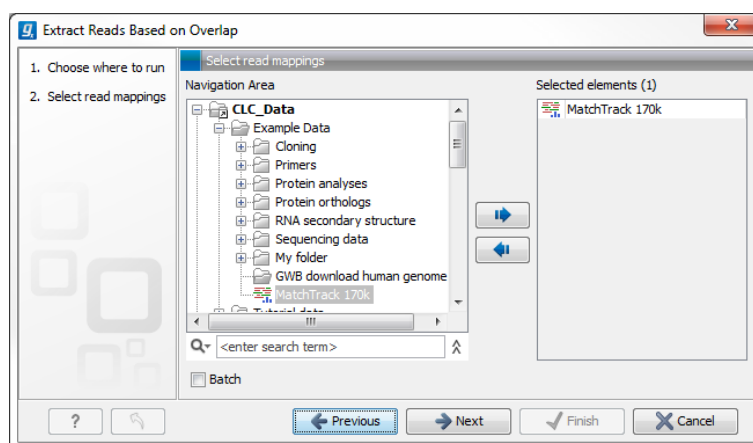

Figure 23.19: Select a read mapping. Only one read mapping can be selected at the time.

The next step is to select the annotated track(s) to be used for pulling out reads and specify which reads to include (figure 23.20). Note that it is also possible to select here a RNA-seq statistical comparison.

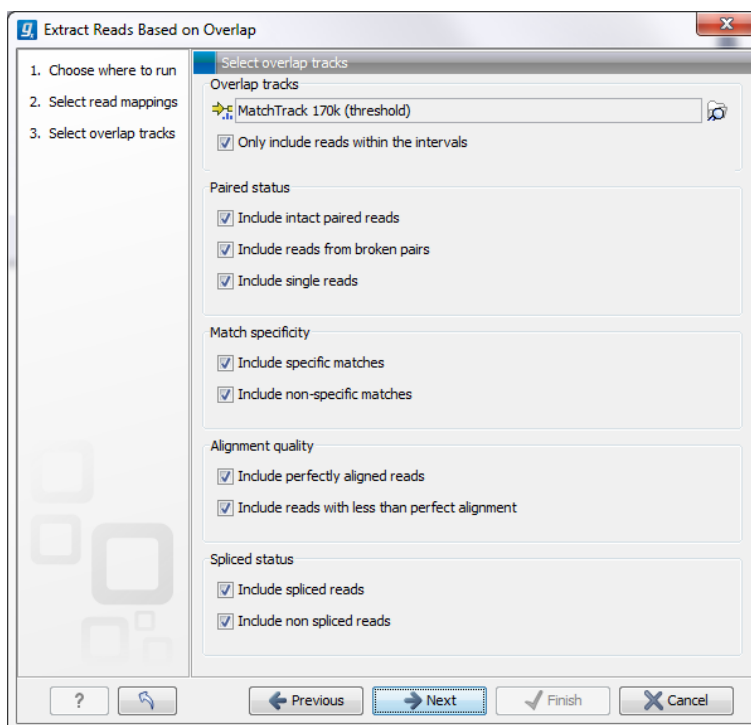

Figure 23.20: Select the track(s) containing the annotation(s) of interest. Multiple tracks can be selected at the same time.

The options in this wizard are:

Overlap tracks

Select the annotated track

Only include reads within the intervals It is possible to select whether only reads within the intervals should be extracted, or whether reads continuing outside the annotated region should be extracted. The difference between the options can be seen in figure 23.21.

Paired status

Include intact paired reads When paired reads are placed within the paired distance specified, they will fall into this category. Per default, these reads are colored in blue.

Include paired reads from broken pairs When a pair is broken, either because only one read in the pair matches, or because the distance or relative orientation is wrong, the reads are placed and colored as single reads, but you can still extract them by checking this box.

Include single reads This will include reads that are marked as single reads (as opposed to paired reads). Note that paired reads that have been broken during assembly are not included in this category. Single reads that come from trimming paired sequence lists are included in this category.

Match specificity

Include specific matches Reads that only are mapped to one position.

Include non-specific matches Reads that have multiple equally good alignments to the reference. These reads are colored yellow per default.

Alignment quality

Include perfectly aligned reads Reads where *the full read* is perfectly aligned to the reference sequence (or consensus sequence for de novo assemblies). Note that at the end of the contig, reads may extend beyond the contig (this is not visible unless you make a selection on the read and observe the position numbering in the status bar). Such reads are not considered perfectly aligned reads because they don't align in their entire length.

Include reads with less than perfect alignment Reads with mismatches, insertions or deletions, or with unaligned nucleotides at the ends (the faded part of a read).

Spliced status

Include spliced reads Reads that are across an intron.

Include non spliced reads Reads that are not across an intron.

Figure 23.20 shows two examples of output when the overlap track used as input was generated using the "Identify Graph Threshold Areas".

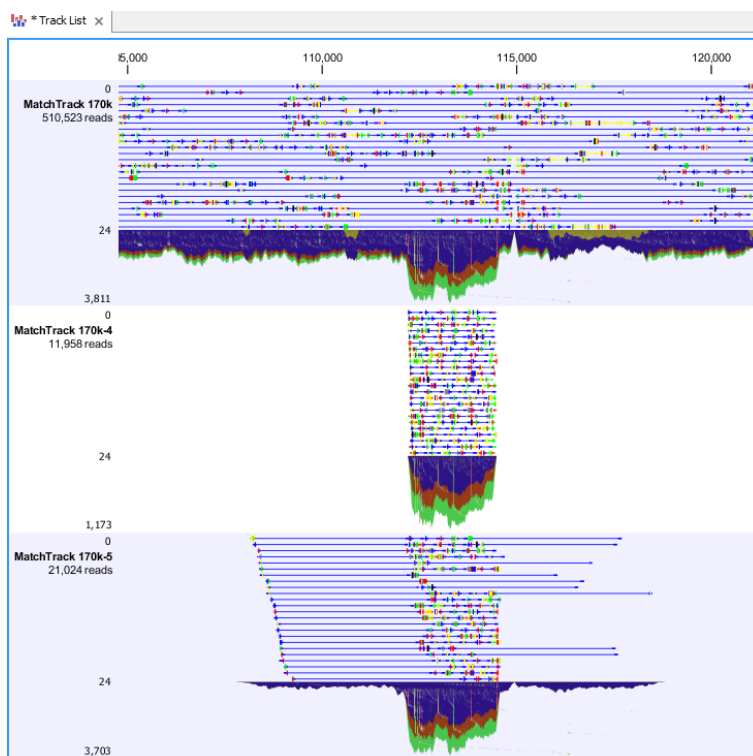

Figure 23.21: Output from Extract reads based on overlap. Top: The read mapping used as input. Middle: Output when "Only include reads within intervals" has been ticked. Bottom: Output when "Only include reads within intervals" has been deselected.

23.5.3 Filter annotations on name

The name filter allows you to use a list of names as input to create a new track only with these names. This is useful if you wish to filter your variants so that only those within certain genes are reported.

The proposed workflow would be to first create a new gene track only containing the genes of interest. This is done using this tool. Next, use the filter from the overlapping annotations tool (see section 23.6) to filter the variants based on the track with genes of interest.

Toolbox | Track Tools | Annotate and Filter | Filter Annotations on Name

Select the track you wish to filter and click **Next**.

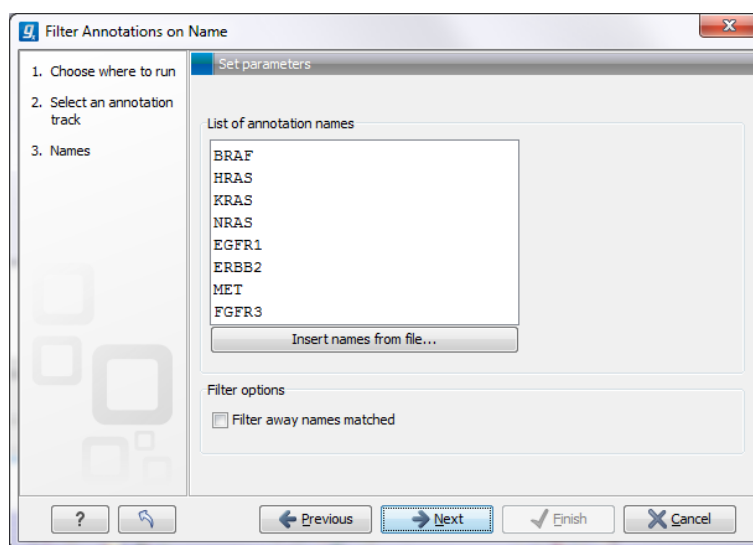

Figure 23.22: Specify names for filtering.

As shown in figure 23.22, you can specify a list of annotation names. Each name should be on a separate line.

In the bottom part of the wizard you can choose whether you wish to keep the annotations that are found, or whether you wish to exclude them. In the use case described above a track was created with only those annotations being kept that matched the specified names. Sometimes the other option may be useful, for example if you wish to screen certain categories of genes from the analysis (for example excluding all cancer genes to reduce the risk of coincidental findings when analyzing patient samples).

23.5.4 Filter Based on Overlap

The overlap filter will be used for filtering an annotation track based on an overlap with another annotation track. This can be used to e.g. only show variants that fall within genes or regulatory regions or for restricting variants results to only cover a subset of genes as explained in section 23.5.3. Please note that for comparing variant tracks, more specific filters should be used (see section 25.14.1).

If you are just interested in finding out whether one particular position overlaps any of the annotations, you can use the advanced table filter and filter on the region column (track tables are described in section 23.1.3).

23.6 Filter Based on Overlap

The overlap filter will be used for filtering an annotation track based on an overlap with another annotation track. This can be used to e.g. only show variants that fall within genes or regulatory regions or for restricting variants results to only cover a subset of genes.

If you are just interested in finding out whether one particular position overlaps any of the annotations, you can use the advanced table filter and filter on the region column (track tables are described in section 23.1.3).

Select the track you wish to filter and click **Next** to specify the track of overlapping annotations (see figure 23.23).

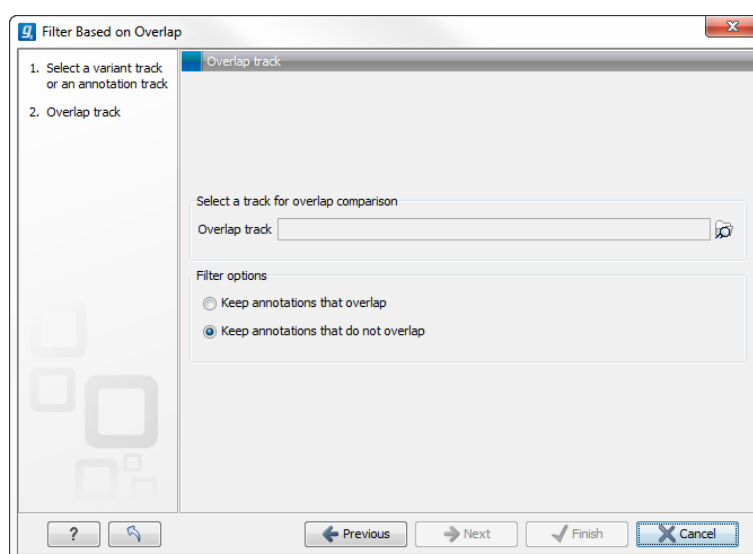

Figure 23.23: Select overlapping annotations track.

Next, select the track that should be used for comparison and tick whether you wish to keep annotations that overlap, or whether to keep annotations that do not overlap with the track selected. An overlap has a simple definition – if the annotation used as input has at least one shared position with the other track, there is an overlap. The boundaries of the annotations do not need to match.

23.7 Graphs

Graphs can be a good way to quickly get an overview of certain types of information. This is the case for e.g. the GC content in a sequence or the read coverage. The *CLC Genomics Workbench* offers two different tools that can create graph tracks from either a sequence or a read mapping. The two available tools are:

- **Create GC Content Graph**
- **Create Mapping Graph**

Both tools are found in the toolbox:

Toolbox | Track Tools  | Graphs

Graph tracks can also be created directly from the track view or track list view by right-clicking the track you wish to use as input, which will give access to the toolbox.

To understand what graph tracks are, we will look at an example. We will use the **Create GC Content Graph** tool to go into detail with one type of graph tracks.

23.7.1 Create GC Content Graph

The **Create GC Content Graph** tool needs a sequence track as input and will create a graph track with the GC contents of that sequence.

To run the tool go to the toolbox:

Toolbox | Track Tools  | Graphs | Create GC Content Graph

Select the sequence track that should be used as input (see figure 23.24).

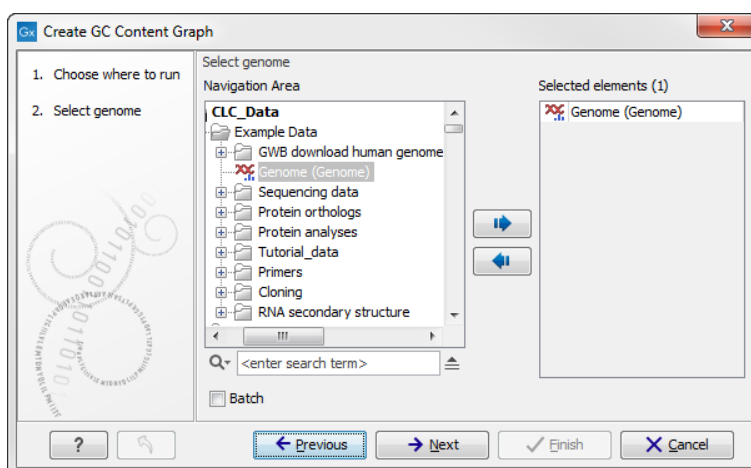

Figure 23.24: Select the sequence track that should be used as input.

Click on the button labeled **Next** to go to the next wizard step (see figure 23.25). In this wizard step you can specify the window size, which is the size of the window around the central base in the region that is used to calculate the GC content. This number must be odd as you need a central base and an equal number of bases to each side of the central base. E.g. with a window size of 25, the GC content for the central base will be calculated based on the nucleotide composition in the central base and the 12 bases upstream and 12 bases downstream of the central base.

Click on the button labeled **Next**, choose to save your results, and click on the button labeled **Finish**. The output can be seen in figure 23.26. The output from "Create GC Content Graph" is a graph track. The graph track shows one value for each base with one graph being available for each chromosome. When zoomed out as shown in this figure, three different graphs with three different colors can be seen. The top graph with the darkest blue color represents the maximum observed GC content values in the specific region, the graph in the middle with the intermediate blue color shows the mean observed GC content values in the specific region, and the graph at the bottom with the light blue color shows the minimum observed GC content values in the specific region.

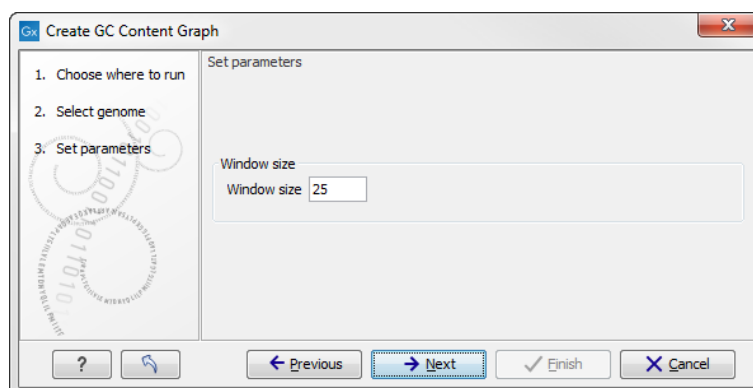

Figure 23.25: Specify the window size. The window size is the region around each individual base that should be used to calculate the GC content in a given region.

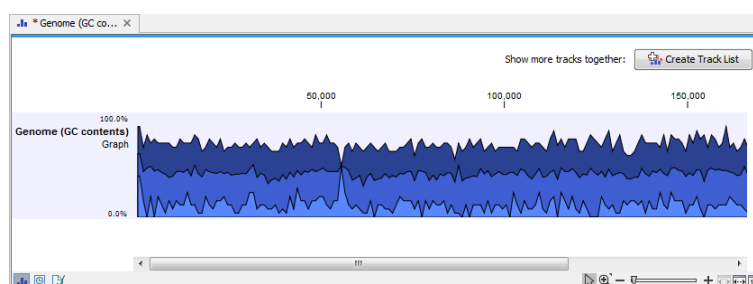

Figure 23.26: The output from "Create GC Content Graph" is a graph track. The graph track shows one value for each base with one graph being available for each chromosome.

When zooming all the way in to single nucleotide level only one graph can now be seen as you are now no longer looking at large genomic regions. Instead, you can now use the tooltip by mousing over each individual base to look at the GC content for that particular base and the number of bases that you specified as the window size to be used. This is shown in figure 23.27 where the top part of the figure shows the graph track when zoomed all the way out and the bottom part of the figure shows a track list with the sequence track that was used as input together with the output graph track. The input and the output tracks were combined in one view as a track list (see section 23.1) by clicking on the button labeled **Create Track List** found in the upper right corner of the graph track in the top part of the figure (see the red arrow).

23.7.2 Create Mapping Graph

The **Create Mapping Graph** tool can create a range of different graphs from a read mapping track. To run the tool go to the toolbox:

Toolbox | **Track Tools** () | **Graphs** | **Create Mapping Graph**

Select the read mapping as shown in figure 23.28 and click on the button labeled **Next**.

Select the graph tracks that you would like to create. The following options exist:

- Read coverage. For each position this graph shows the number of reads contributing to the alignment (see a more elaborate definition in section 24.2.8).
- Non-specific read coverage. Non-specific reads are reads that would fit equally well other places in the reference genome.

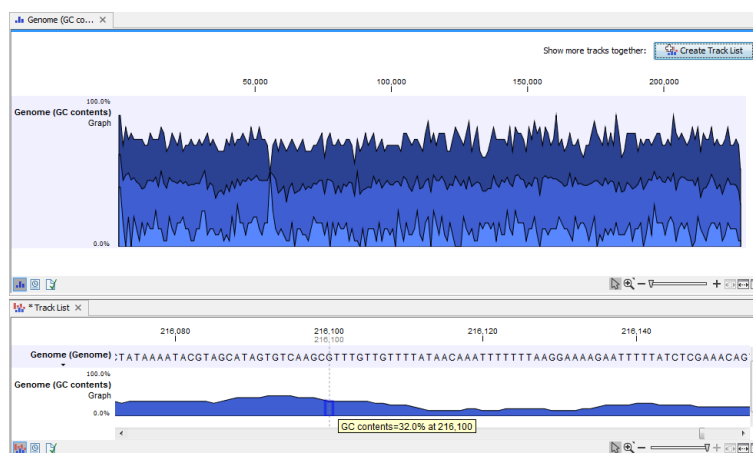

Figure 23.27: The top part of the figure shows the graph track when zoomed all the way out. The bottom part of the window shows a graph track together with the input genomic sequence at single nucleotide resolution. By mousing over one nucleotide, you can see the GC content for this position. In our example we chose a window size of 25 nucleotides and the GC content that is shown for one nucleotide is the GC content for the central nucleotide and the 12 bases upstream and downstream of this nucleotide.

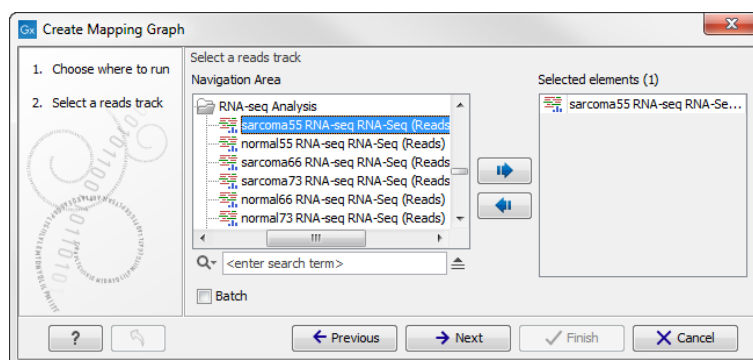

Figure 23.28: Creating graph track from mappings.

- Unaligned ends coverage. Un-aligned ends arise when a read has been locally aligned to a reference sequence, and then end of the read is left unaligned because there are mismatches or gaps relative to the reference sequence. This part of the read does not contribute to the read coverage above. The unaligned ends coverage graph shows how many reads that have unaligned ends at each position.
- Non-perfect read coverage. Non-perfect reads are reads with one or more mismatches or gaps relative to the reference sequence.
- Paired read coverage. This lists the coverage of intact pairs. If there are no single reads and no pairs are broken, it will be the same as the standard read coverage above.
- Paired end distance. Displays the average distance between the forward and the reverse read in a pair. A pair contributes to this graph from the beginning of the first read to the end of the second read.
- Broken pair coverage. A pair is broken either because only one read in the pair matches, or because the distance or relative orientation between the reads is wrong.

- Reads start coverage. For each position this graph shows the number of reads that start in that position.

One graph track output will be created for each of the graph tracks you have chosen by checking the boxes shown in figure 23.29.

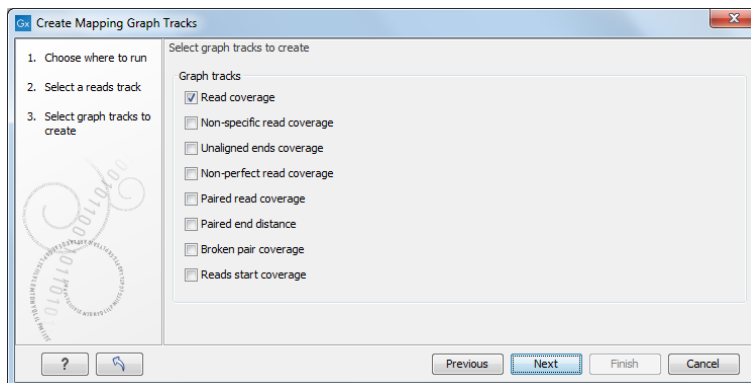

Figure 23.29: Choose the types of graph tracks you would like to generate.

Click on the button labeled **Next**, choose where to save the generated output(s) and click on the button labeled **Finish**.

An example of three different outputs is shown in figure 23.30. Two of the views have been dragged and dropped to other areas of the **View Area** to be able to see them in the same window. If you would like to learn more about how to do this, please refer to section 2.1.7.

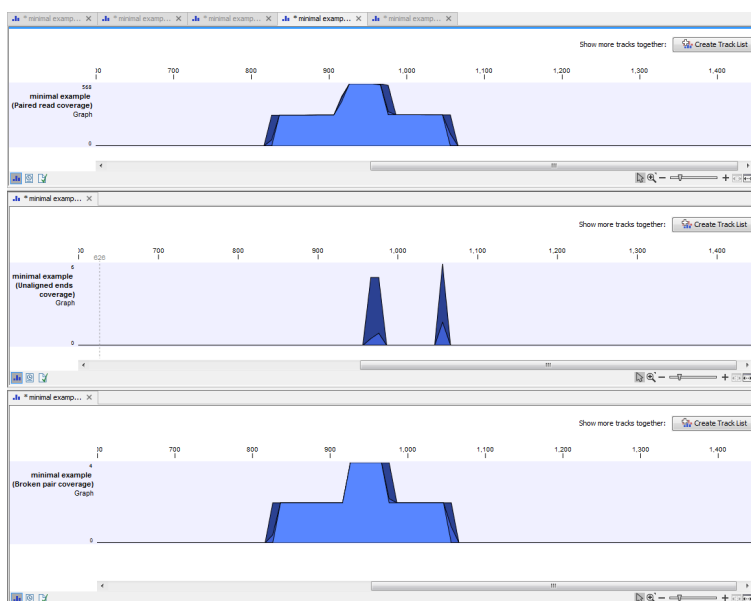

Figure 23.30: Three types of graph tracks are shown.

In this example we generated all possible outputs and chose to open them without saving. You can see that the names of the tabs are marked with an asterisk, which indicates that the graph shown in the view area has not been saved or that changes have been made that must be saved if you want to keep them. Three of the generated outputs have been opened. If you would like to see the outputs in the same view, you can do this by creating a track list. Click on the button labeled **Create Track List** in the upper right corner of each of the graph tracks shown in the **View**

Area. Combining graph tracks in a track list links the individual tracks together, which makes it much easier to compare the different graph tracks.

Another thing that is worth noting is the options found in the **Side Panel**. In particular the option "Fix graph bounds" found under **Track layout** is useful to know if you would like to manually adjust the numbers on the y-axis.

23.7.3 Identify Graph Threshold Areas

The **Identify Graph Threshold Areas** tool uses graph tracks as input to identify graph regions that fall within certain limits or thresholds. Both a lower and an upper threshold can be specified to create an annotation track for those regions of a graph track where the values are in the given range (see figure 23.31). The range chosen for the lower and upper thresholds will depend on the data (coverage, quality etc).

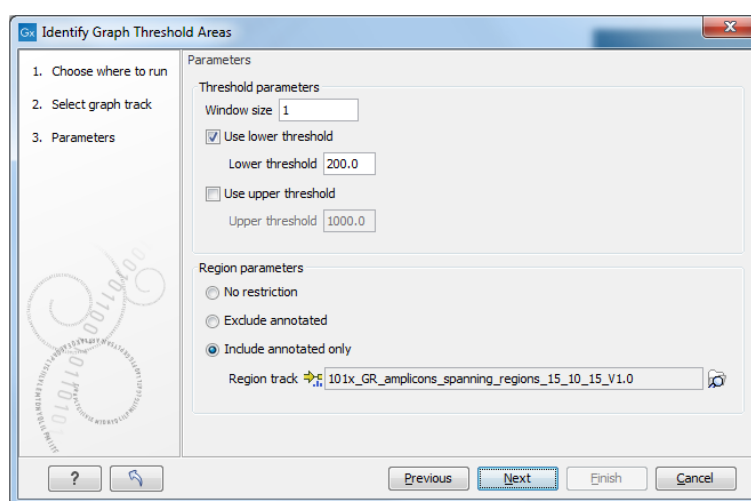

Figure 23.31: Specification of lower and upper thresholds.

The **window-size** parameter specifies the width of the window around every position that is used to calculate an average value for that position and hence "smooths" the graph track beforehand. A window size of 1 will simply use the value present at every individual position and determine if it is within the upper and lower threshold, hence resulting in the same "non-smoothing" behavior as previous versions of the workbench without this parameter. In contrast, a window size of 100 checks if the average value derived from the surrounding 100 positions falls between the minimum and maximum threshold. Such larger windows help to prevent "jumps" in the graph track from fragmenting the output intervals or help to detect over-represented regions in the track that are only visible when looked at in the context of larger intervals and lower resolution.

It is also possible to restrict the tool to certain regions. This is useful when looking for low coverage regions restricted to certain amplicons.

An example output is shown in figure 23.32 where the coverage graph has a couple of local minima near zero. However, by using the averaging window, the tool is able to produce a single unbroken annotation covering the entire region. Of course larger window sizes result in regions that are broader and hence their boundaries are less likely to exactly coincide with the borders of visually recognizable borders of regions in the track.

When zoomed out, the graph tracks are composed of three curves showing the maximum, mean,

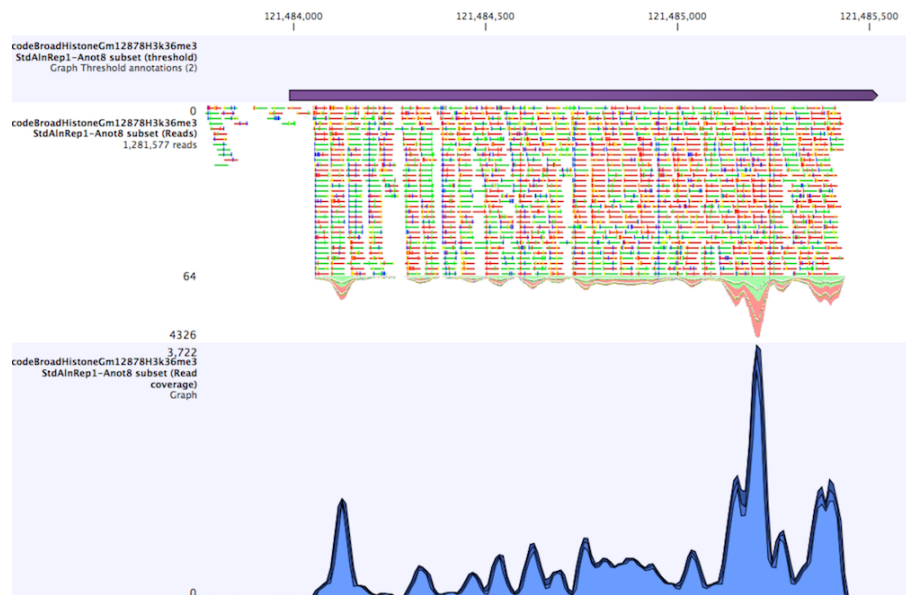

Figure 23.32: Track list including a region identified by the parameters set above on a dataset of H3K36 methylation from ENCODE. The top track shows the resulting region. Below is the track containing the reads. The graph track at the bottom shows the coverage with the minimum, mean, and maximum observed values.

and minimum value observed in a given region (see figure 23.32). When zoomed in all the way down to base resolution only one curve will be shown reflecting the exact observation at each individual position.

Chapter 24

Read mapping

Contents

24.1 Map Reads to Reference	601
24.1.1 Selecting reads and reference	601
24.1.2 Including or excluding regions (masking)	602
24.1.3 Mapping parameters	602
24.1.4 Mapping paired reads	606
24.1.5 Non-specific matches	607
24.1.6 Gap placement	608
24.1.7 Computational requirements	609
24.1.8 Reference Caching	610
24.2 Mapping output	610
24.2.1 Mapping output options	610
24.2.2 Mapped reads coloring	611
24.2.3 Reads track output from a read mapping	613
24.2.4 Stand-alone read mapping	617
24.2.5 Mapping table	618
24.2.6 Mapping view settings	619
24.2.7 Overlapping paired reads	622
24.2.8 Find broken pair mates	622
24.3 Mapping reports	623
24.3.1 Summary mapping report	624
24.3.2 Detailed mapping report	626
24.4 Mapping SOLid reads in color space	632
24.4.1 Viewing color space information	633
24.4.2 Mapping in color space	634
24.5 Local realignment	637
24.5.1 Method	637
24.5.2 Realignment of unaligned ends	637
24.5.3 Guided Realignment	638
24.5.4 Multi-pass local realignment	640
24.5.5 Known Limitations	640

24.5.6	Computational Requirements	641
24.5.7	How to run the Local Realignment tool	642
24.6	Merge mapping results	644
24.7	Remove duplicate mapped reads	645
24.7.1	Algorithm details and parameters	646
24.7.2	Running the duplicate reads removal	648
24.8	Extract consensus sequence	648
24.9	Sample reads	652

24.1 Map Reads to Reference

Read mapping is a very fundamental step in most applications of high-throughput sequencing data. The *CLC Genomics Workbench* includes read mapping in several other tools (e.g. in the RNA-Seq Analysis), but this chapter will focus on the core read mapping algorithm. At the end of the chapter you can find descriptions of the read mapping reports and a tool to merge read mappings.

There are two different versions of the core mapper: one for color space data, and one for base space data. At <http://www.qiagenbioinformatics.com/support/resources/> you can find white papers with detailed benchmarks and descriptions of both algorithms.

The following description focuses on the parameters that can be directly influenced by the user.

24.1.1 Selecting reads and reference

To start the read mapping:

Toolbox | NGS Core Tools (📁) | Map Reads to Reference (🔍)

In the first dialog, select the sequences or sequence lists containing the sequencing data (figure 24.1). Please note that reads longer than 100,000 bases are not supported.

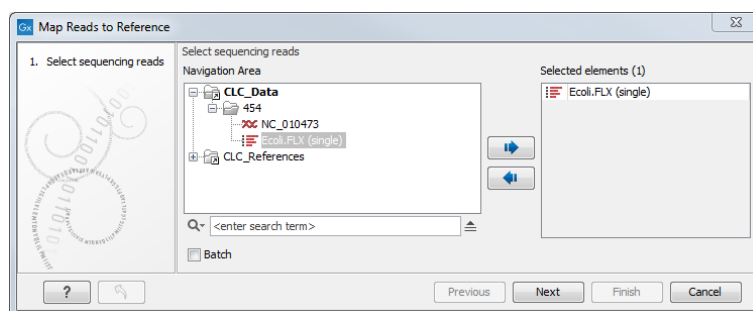

Figure 24.1: Specifying the reads as input. You can also choose to work in batch.

When the sequences are selected, click **Next**, and you will see the dialog shown in figure 24.2.

At the top you select one or more reference sequences by clicking the **Browse and select element** (🔍) button. You can select either single sequences, a list of sequences or a sequence track as reference. Note the following constraints:

- single reference sequences longer than 2gb ($2 \cdot 10^9$ bases) are not supported.

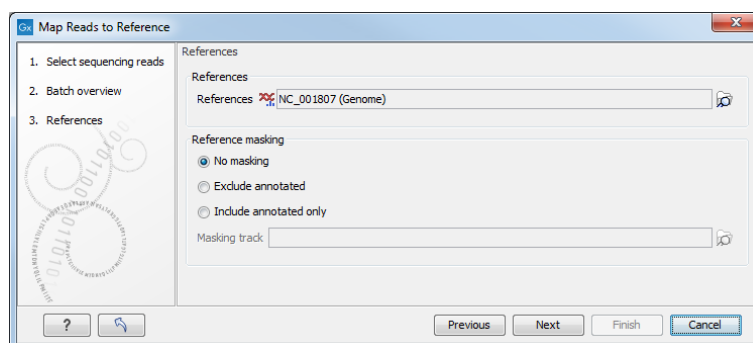

Figure 24.2: Specifying the reference sequences and masking.

- a maximum of 120 input items (sequence lists or sequence elements) can be used as input to a single read mapping run.

24.1.2 Including or excluding regions (masking)

The next part of the dialog shown in figure 24.2 lets you *mask* the reference sequences. Masking refers to a mechanism where parts of the reference sequence are not considered in the mapping. This can be useful for example when mapping data is captured from specific regions (e.g. for amplicon resequencing). The read mapping will still base its output on the full reference - it is only the core read mapping that ignores regions.

Masking is performed by discarding the masked out nucleotides. As a result the reference is split into separate sequences, which are positioned according to the original unmasked reference sequence.

Note that you should be careful that your data is indeed only sequenced from the target regions. If not, some of the reads that would have matched a masked-out region perfectly may be placed wrongly at another position with a less-perfect match and lead to wrong results for subsequent variant calling. For resequencing purposes, we recommend testing whether masking is appropriate by running the same data set through two rounds of read mapping and variant calling: one with masking and one without. At the end, comparing the results will reveal if any off-target sequences cause problems in the variant calling.

Masking out repeats or using other masks with many regions is not recommended. Repeats are handled well and does not cause any slowdown. On the contrary, masking repeats is likely to cause a dramatic slowdown in speed, increase memory requirements and lead to incorrect read placement.

To mask a reference sequence, first click the **Include** or **Exclude** options, and second click the **Browse** (🔍) button to select a track to use for masking. If you have annotations on a sequence instead of a track, you can convert the annotation type to a track (see section 23.4).

24.1.3 Mapping parameters

Clicking **Next** leads to the parameters for the read mapping (see figure 24.3).

The first parameter allows the mismatch cost to be adjusted:

- **Match score** The positive score for a match between the read and the reference sequence.

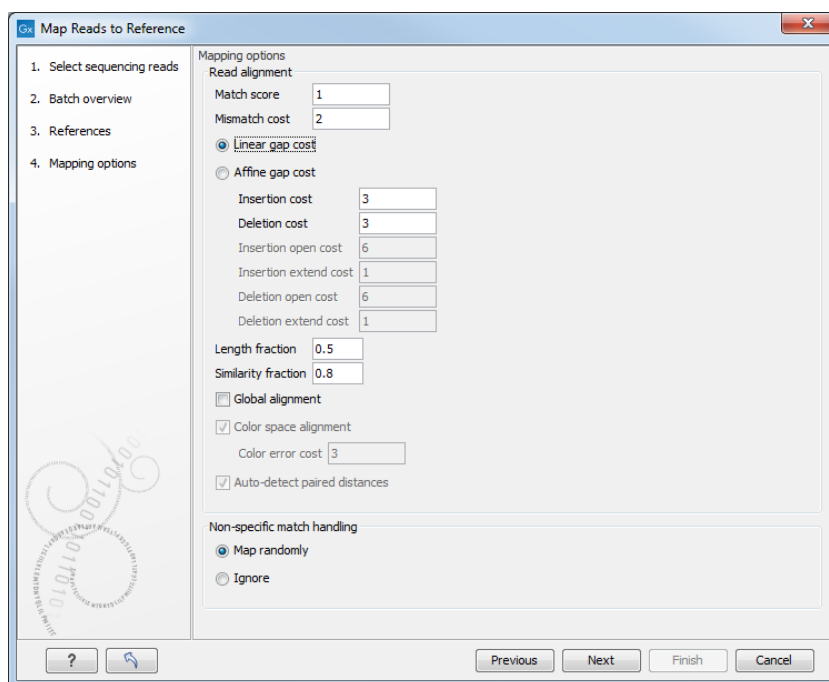

Figure 24.3: Setting parameters for the mapping.

It is set by default to 1 but can be adjusted up to 10.

- **Mismatch cost** The cost of a mismatch between the read and the reference sequence. Ambiguous nucleotides such as "N", "R" or "Y" in read or reference sequences are treated as a mismatches and any column with one of these symbols will therefore be penalized with the mismatch cost.

After setting the mismatch cost you need to choose between linear gap cost and affine gap cost, and depending on the model you chose, you need to set two different sets of parameters that control how gaps in the read mapping are penalized.

- **Linear gap cost** The cost of a gap is computed directly from the length of the gap and the insertion or deletion cost. This model often favors small, fragmented gaps over long contiguous gaps. If you choose linear gap cost, you must set the insertion cost and the deletion cost:

Insertion cost The cost of an insertion in the read (a gap in the reference sequence). The cost of an insertion of length ℓ will be

$$\ell \cdot \text{Insertion cost}, \quad (24.1)$$

Deletion cost The cost of a deletion in the read (gap in the read sequence). The cost of a deletion of length ℓ will be

$$\ell \cdot \text{Deletion cost}. \quad (24.2)$$

- **Affine gap cost** An extra cost associated with opening a gap is introduced such that long contiguous gaps are favored over short gaps. If you chose affine gap cost, you must also set the cost of opening an insertion or a deletion:

Insertion open cost The cost of opening an insertion in the read (a gap in the reference sequence).

Insertion extend cost The cost of extending an insertion in the read (a gap in the reference sequence) by one column.

Deletion open cost The cost of opening a deletion in the read (gap in the read sequence).

Deletion extend cost The cost of extending a deletion in the read (gap in the read sequence) by one column.

Using, affine gap cost, an insertion of length ℓ is penalized by

$$\text{Insertion open cost} + \ell \cdot \text{Insertion extend cost}, \quad (24.3)$$

and a deletion of length ℓ is penalized by

$$\text{Deletion open cost} + \ell \cdot \text{Deletion extend cost}. \quad (24.4)$$

In this way long consecutive gaps get a lower cost per column than small fragmented gaps and they are therefore favored.

The score of a match between the read and the reference is set to 1 by default. Adjusting the cost parameters above can improve the mapping quality, e.g. when the read error rate is high or the reference is expected to differ significantly from the sequenced organism. For example, if the reads are expected to contain many insertions and/or deletions, it can be a good idea to lower the insertion and deletion costs to allow more of such errors. However, one should also consider the possible drawbacks when adjusting these settings. For example, reducing the insertion and deletion cost increases the risk of mapping reads to the wrong positions in the reference.

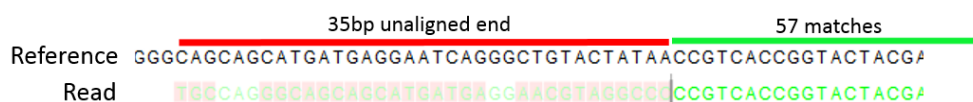

Figure 24.4: An alignment of a read where a region of 35bp at the start of the read is unaligned while the remaining 57 nucleotides matches the reference.

Figure 24.4 shows an example using linear gap cost where the read mapper is unable to map a region in a read due to insertions in the read and mismatches between the read and the reference. The aligned region of the read has a total of 57 matching nucleotides which result in an alignment score of 57 which is optimal when using the default cost for mismatches and insertions/deletions (2 and 3 respectively). If the mapper had aligned the remaining 35bp of the read as shown in Figure 24.5 using the default scoring scheme, the score would become:

$$(26 + 1 + 3 + 57) * 1 - 5 * 2 - 8 * 3 = 53 \quad (24.5)$$

In this case, the alignment shown in Figure 24.4 is optimal since it has the highest score. However, if either the cost of deletions or mismatches were reduced by one, the score of the alignment shown in Figure 24.5 would become 61 and 58, respectively, and thus make it optimal.

Once the optimal alignment of the read is found, based on the cost parameters described above, a filtering process determines whether this match is good enough for the read to be included in the output. The filtering threshold is determined by two factors:

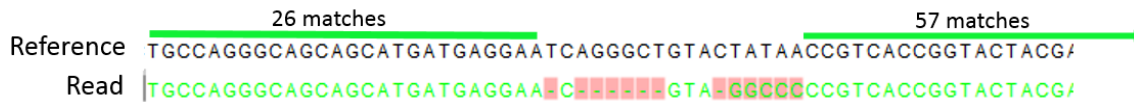

Figure 24.5: An alignment of a read containing a region with several mismatches and deletions. By reducing the default cost of either mismatches or deletions the read mapper can make an alignment that spans the full length of the read.

- Length fraction** The minimum percentage of the total alignment length that must match the reference sequence at the selected similarity fraction. A fraction of 0.5 means that at least half of the alignment must match the reference sequence before the read is included in the mapping (if the similarity fraction is set to 1). Note, that the minimal seed (word) size for read mapping is 15 bp, so reads shorter than this will not be mapped.
- Similarity fraction** The minimum percentage identity between the aligned region of the read and the reference sequence. For example, if the identity should be at least 80% for the read to be included in the mapping, set this value to 0.8. Note that the similarity fraction relates to the length fraction, i.e. when the length fraction is set to 50% then at least 50% of the alignment must have at least 80% identity (see figure 24.6).

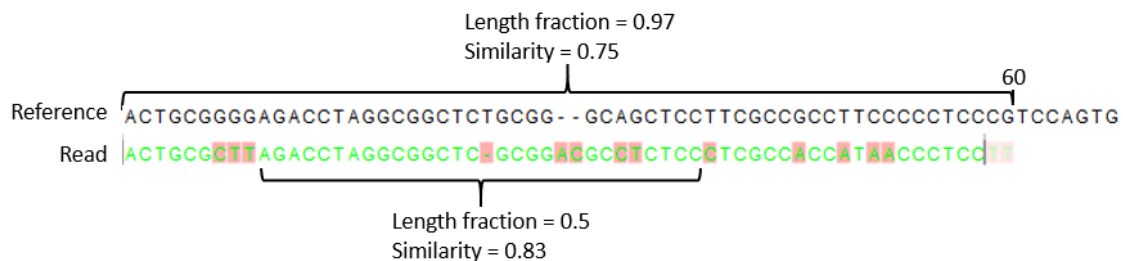

Figure 24.6: A read containing 59 nucleotides where the total alignment length is 60. The part of the alignment that gave rise to the optimal score has length 58 which excludes 2 bases at the left end of the read. The length fraction of the matching region in this example is therefore $58/60 = 0.97$. Given a minimum length fraction of 0.5, the similarity fraction of the alignment is computed as the maximum similarity fraction of any part of the alignment which constitute at least 50% of the total alignment. In this example the marked region in the alignment with length 30 (50% of the alignment length) has a similarity fraction of 0.83 which will satisfy the default minimum similarity fraction requirement of 0.8.

- Global alignment** By default, mapping is done with **local alignment** of the reads to the reference. The advantage of performing local alignment instead of global alignment is that the ends are automatically left unaligned if there are many differences from the reference at the ends. For many sequencing platforms, the quality of the bases drop along the read, and a local alignment approach is desirable. Note that the aligned region has to be greater than the length threshold set. If **global alignment** is preferred, it can be enabled with a checkbox as shown in figure 24.3.
- Color space alignment** When mapping data in color space (data from SOLiD systems), the **color space** checkbox is enabled, and a corresponding cost for color errors can be set. If you do not have color space data, these will be disabled and are not relevant. For more details about this, please see section 24.4 which explains how color space mapping is performed in greater detail.

24.1.4 Mapping paired reads

- Auto-detect paired distances** At the bottom of the dialog shown in figure 24.3 you can specify how **Paired reads** should be handled. You can read more about how paired data is imported and handled in section 6.3.9. If the sequence list used as input contains paired reads, this option will automatically be enabled - if it contains single reads, this option will not be applicable.

The *CLC Genomics Workbench* offers as the default choice to automatically calculate the distance between the pairs. If this is selected, the distance is estimated in the following way:

- A sample of 100,000 reads is extracted randomly from the full data set and mapped against the reference using a very wide distance interval.
- The distribution of distances between the paired reads is analyzed, and an appropriate distance interval is selected:
 - If less than 10,000 reads map, a simple calculation is used where the minimum distance is one standard deviation below the average distance, and the maximum distance is one standard deviation above the average distance.
 - If more than 10,000 reads map, a more sophisticated method is used which investigates the shape of the distribution and finds the boundaries of the peak.
- The full sample is mapped using this distance interval.
- The **history** (📄) of the result records the distance interval used.

The above procedure will be run for each sequence list used as input, assuming that they do not necessarily share the same library preparation and could have different distributions of paired distances. Figure 24.7 shows an example of the distribution of intervals with and without automatic pair distance interval estimation.

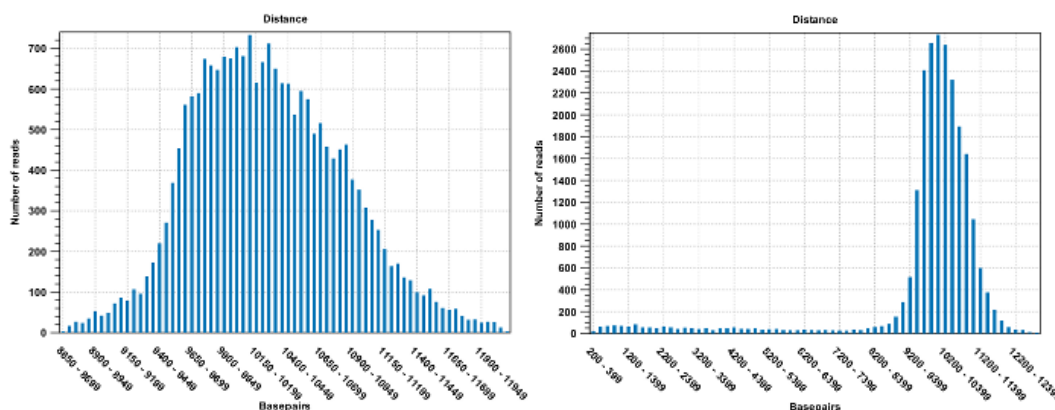

Figure 24.7: To the left: mapping with a narrower distance interval estimated by the workbench. To the right: mapping with a large paired distance interval (note the large right tail of the distribution).

Sometimes the automatic estimation of the distance between the pairs may return a warning "multiple intervals detected". This may happen if the reads derive from multiple libraries or from certain types of amplicon sequencing protocols. In this case, the estimates may still be correct, but, if in doubt, the user may want to disable the option to automatically estimate paired

distances and instead manually specify minimum and maximum distances between pairs on the input sequence list.

If the automatic detection of paired distances is not checked, the mapper will use the information about minimum and maximum distance recorded on the input sequence lists (see section 6.3.9).

The 'automatic detection of paired distance' option when mapping should be used with caution. It is possible that the estimated distance setting is too narrow and consequently many read pairs will be flagged broken. Sometimes, a second peak in the Paired Distance distribution graph is not picked up on by the estimation tool.

If a large portion of pairs are flagged 'Broken' we recommend the following:

1. Inspect the detailed mapping report (see section 24.3.2) to deduce a distance setting interval - and compare this to the estimated distance used by the mapper (found in the mapping history).
2. Open the paired reads list and set a broad paired distance in the Elements tab. Then run a new mapping with the 'auto-detect...' OFF. Make sure to have a report produced. Open this report and look at the Paired Distance Distribution graph. This will tell you the distances that your pairs did map with. Use this information to narrow down the distance setting and perhaps run a third mapping using this.
3. Another cause of excessive amounts of broken pairs is misspecification of the read pair orientation. This can be changed in the Elements tab of the paired reads list prior to running a mapping.

See section 24.3.2 for further information.

When a paired distance interval is set, the following approach is used for determining the placement of read pairs:

- First, all the optimal placements for the two individual reads are found.
- Then, the allowed placements according to the paired distance interval are found.
- If both reads can be placed independently but no pairs satisfies the paired criteria, the reads are treated as independent and marked as a **broken pair**.
- If only one pair of placements satisfy the criteria, the reads are placed accordingly and marked as uniquely placed even if either read may have multiple optimal placements.
- If several placements satisfy the paired criteria, the pair is treated as a non-specific match (see section 24.1.5 for more information.)
- If one read is uniquely mapped but the other read has several placements that are valid given the distance interval, the mapper chooses the location that is closest to the first read.

24.1.5 Non-specific matches

At the bottom of the dialog, you can specify how **Non-specific matches** should be treated. The concept of Non-specific matches refers to a situation where a read aligns at *more than one position with an equally good score*. In this case you have two options:

- **Random.** This will place the read in one of the positions randomly.
- **Ignore.** This will not include the read in the final mapping.

Note that a read is only considered non-specific when the read matches equally well at several alignment positions. If there are e.g. two possible alignment positions and one of them is a perfect match and the other involves a mismatch, the read is placed at the position with the perfect match and it is not marked as a non-specific match.

For paired data, reads are only considered non-specific matches if the entire pair could be mapped elsewhere with equal scores for both reads, or if the pair is broken in which case a read can be categorized as non-specific in the same way as single reads (see section 24.1.4).

When looking at the mapping, the default color for non-specific matches is yellow.

24.1.6 Gap placement

In the case of insertions or deletions in homopolymeric or repetitive regions, the precise placement of the insertion or deletion cannot be determined from the data. An example is shown in figure 24.8.

```

TTCTCAAACAAT
TTCTC-AACAAT
TTCTC-AACAAT
TTCTC-AACAAT
TTCTC-AACAAT
TTCTC-AACAAT
TTCTC-AACAAT

```

Figure 24.8: Three A's in the reference (top) have been replaced by two A's in the reads (shown in red). The gap is placed towards the 5' end, but could have been placed towards the 3' end with an equally good mapping score for the read.

In this example, three A's in the reference (top) have been replaced by two A's in the reads (shown in red). The gap is placed towards the 5' end (left side), but could have been placed towards the 3' end with an equally good mapping score for the read as shown in figure 24.9.

```

TTCTCAAACAAT
TTCTCAA-CAAT
TTCTCAA-CAAT
TTCTCAA-CAAT
TTCTCAA-CAAT
TTCTCAA-CAAT
TTCTCAA-CAAT

```

Figure 24.9: Three A's in the reference (top) have been replaced by two A's in the reads (shown in red). The gap is placed towards the 3' end, but could have been placed towards the 5' end with an equally good mapping score for the read.

Since either way of placing the gap is arbitrary, the goal of the mapper is to place the gaps consistently at the same side for all reads.

Many insertions and deletions in homopolymeric or repetitive regions reported in the public databases dbSNP and 1000Genomes have been identified based on mappings done with tools like BWA and Bowtie, that place insertions or deletions at the left side of a homopolymeric tract. Thus, to help facilitate the comparison of variant results with such public resources, the **Map Reads to Reference** tool, as of version 6.5 of the *CLC Genomics Workbench*, will place insertions or deletions in homopolymeric tracts at the left hand side.

This is a change to earlier versions of the *CLC Genomics Workbench* (version 6.0.5 and earlier) where the read mapper placed insertions and deletions in homopolymeric tracts at the right hand side of the homopolymer, as viewed in the Workbench.

This has the implication that insertion and deletion variants called in homopolymeric regions will be in different positions relative to the reference when based on mappings run in version 6.0.5 and earlier, compared to variant calls based on mappings run in version 6.5 and later. Thus, if comparisons between sample variant tracks will be done in the *CLC Genomics Workbench*, we recommend re-running mappings so all samples are mapped using the mapping tool in version 6.5 of the *CLC Genomics Workbench* or higher, or all samples to be compared have been mapped using version 6.0.5 and lower.

For users of the COSMIC database or other clinical databases following the recommendations from the Human Genome Variation Society (HGVS) The Human Genome Variation Society (HGVS) recommendations, which pertain to variants within genes, state that for insertions and deletions in homopolymeric or repetitive regions, the most 3' position (corresponding to the strand of the gene) possible should be arbitrarily assigned as the site of change (see <http://www.hgvs.org/mutnomen/recs-DNA.html#del>). Resources such as COSMIC adhere to these recommendations. In this case, placement to the farthest possible left hand position, as viewed in the *CLC Genomics Workbench*, of insertions or deletions in repetitive or homopolymeric tracts, has a different effect, depending on whether the gene involved is on the positive or negative strand of the reference. Such variants located within genes on the negative strand can be compared with the COSMIC database, while those within genes lying on the positive strand cannot be, as the positions relative to the reference will be different in this case.

The opposite situation is true when variant calls are based on mappings run in version 6.0.5 of the *CLC Genomics Workbench* or earlier. That is, if comparing to a resource following HGVS recommendations, like COSMIC, insertions and deletions in homopolymeric or repetitive regions called within genes that lie on the positive strand will be comparable based on position relative to the reference, while those within genes on the negative strand will not be.

24.1.7 Computational requirements

The memory requirements of **Map Reads to Reference** depends on four factors. The size of the reference, the length of the reads, the read error rate and the number of CPU cores available. The limiting factor is often the size of the reference while the contribution of the other three factors to the total memory consumption is usually small (see below).

A good estimate for the memory required by the base space read mapper to represent a reference is one MB for each Mbp in the reference. For example the human reference genome requires $3200 * 1MB = 3.2GB$ of memory. The color space mapper is able to scale down its memory consumption, such that even large references can be represented using small amounts of memory. However, when the memory consumption is scaled down it causes the read mapping to

become slower.

When mapping short high quality reads, such as Illumina reads, the added memory consumption per CPU core is small. However, when mapping long reads with a high error rate, such as PacBio reads, each CPU core can add several hundred MB to the total memory consumption. Consequently, mapping long reads with high error rate on a machine with many CPU cores, can cause a large increase in the memory requirements for all CLC read mappers. An additional 4GB of memory should be reserved for the *CLC Genomics Workbench*, and thus the recommended minimum amount of memory for mapping short high quality reads (e.g. Illumina reads) to the human genome is 8GB.

24.1.8 Reference Caching

In some cases repeated mappings against the same reference will result in a dramatically reduced runtime because the internal data structure used for mapping the reads, which is reference specific, can be reused. This has been enabled by storing files in the system tmp folder as a caching mechanism. Only a certain amount of disk space will be used and once reaching the limit, the oldest files are cleaned up. Consequently, the reference data structure files will automatically have to be recreated if the cache was filled or the tmp folder was cleaned up.

The default space limit is 8 GB which can be changed by going to

Edit | Preferences | Advanced | Read Mapper

On the server and for webstart the cache size can be controlled by creating a settings file "readmapper.properties" with an entry going like this "referencecachesize = 8589934592" where the size is in bytes. On grid setups, the "readmapper.properties" file will have to be added manually to each grid worker directory.

24.2 Mapping output

24.2.1 Mapping output options

Click **Next** lets you choose how the output of the mapping should be reported (see figure 24.10).

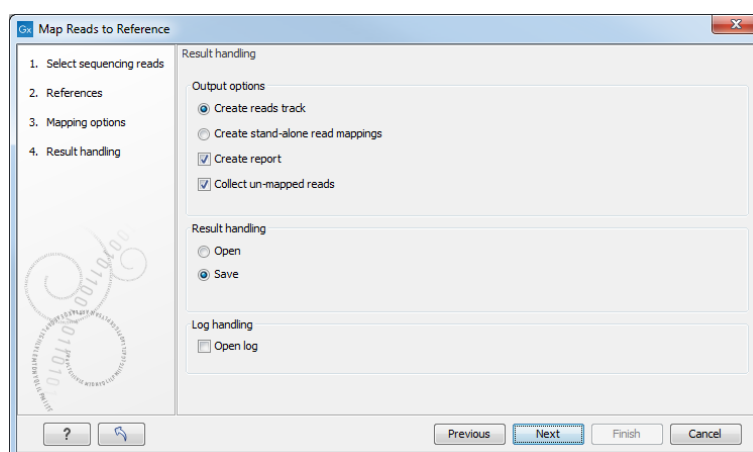

Figure 24.10: Mapping output options.

The main choice in output format is at the top of the dialog - the read mapping can either be stored as a track or as a stand-alone read mapping. Both options have distinct features and advantages:

Reads track A reads track is very "lean" (i.e. with respect to memory requirements) since it only contains the reads themselves. Additional information about the reference, consensus sequence or annotations can be added and viewed alongside in the context of a Track List later (by adding, for example, a reference and/or annotation track, respectively). This kind of output is useful when working with tracks in general and especially for resequencing purposes this is recommended. Details about viewing and editing of reads-tracks are described in section 23. The main advantage of having the output of the read-mapping process represented as a track is that this way it seamlessly integrates with other downstream analysis tools. In contrast, the stand-alone read mapping output has a couple of specialized functions which are not directly available for single reads-tracks but requires the context of the overall tracks-framework. However, unless any specific functionality of the stand-alone read-mapping is required, we recommend to use the tracks output for the additional flexibility in further analysis. Later it is possible to convert to and from tracks (see section 23.4). The side-panel functionality for viewing a read track and an annotation track is shown in Figure 24.18.

Stand-alone read mapping This output is more elaborate than the reads track and includes the full reference sequence (including annotations) and a consensus sequence is created as part of the output. Furthermore, the possibilities for detailed visualization and editing are richer than for the reads track (see section 17.7). The down-side of a stand-alone read mapping is that it copies all the information from the reference sequence which can take up a lot of disk space, and second that it does not lend itself to comparative analyses. If you wish to compare e.g. SNPs from one sample to another sample, or against a database of variants, this calls for using a reads-track instead. Note that if multiple reference sequences are used as input, a read mapping table is created (see section 24.2.5).

In addition to the choice between the two main output options, there are two independent output options available that can be (de-)activated in both cases:

- **Create report.** This will generate a summary report as described in section 24.3.1.
- **Collect un-mapped reads.** This will collect all the reads that could not be mapped to the reference into a sequence list (there will be one list of unmapped reads per sample, and for paired reads, there will be one list for intact pairs and one for single reads where the mate could be mapped).

Note that the Map Reads to Reference tool will output an empty read mapping and report when nothing mapped, and empty unmapped reads if everything mapped.

Finally, you can choose to save or open the results, and if you wish to see a log of the process, see section 8.2.

Clicking **Finish** will start the mapping.

24.2.2 Mapped reads coloring

The mapped reads are colored by default according to the following color code:

- Single reads mapping in their forward direction are green.
- Single reads mapping in their reverse direction are red.
- Paired reads are blue. The thick line represents the read itself; the thin line represents the distance between each read in the pair. Note that reads from broken pairs are colored according to their forward/reverse orientation or as a non-specific match.
- Non-specific matches are yellow. When a read would have matched equally well another place in the mapping, it is considered a non-specific match. This color will "overrule" the other colors. Note that when mapping to several reference sequences, i.e. chromosomes, a read is considered a double match when it matches more than once across all the chromosomes.

Unaligned ends, that is the part of the reads that is not mapped to the reference (also known as soft-clipped read ends) will be shown with a faded color, e.g. light green, light red, light blue or light yellow, depending on the color of the read.

In a stand alone read mapping, reads that are members of a broken pair are highlighted in darker shades of the read color, unless the Read layout is set to "Packed" (see figure 24.11). In a reads track, members of a broken pair are not highlighted in darker shades of the read color.

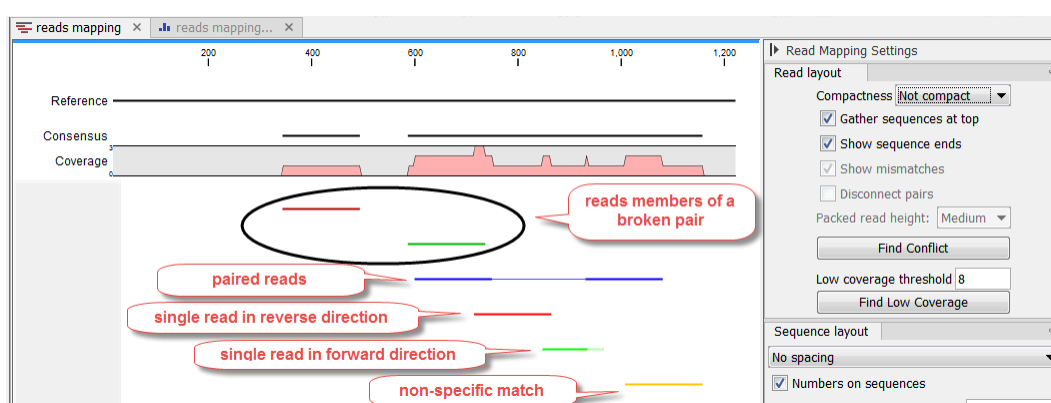

Figure 24.11: Default reads color for a stand alone read mapping when compactness is not set to "Packed".

In a stand alone read mapping, these default colors can be changed using the functionalities of the side panel (see section 24.2.6).

Mismatches between the read and reference are shown as narrow vertical traits following the Rasmol color scheme (figure 24.12):

- A - red.
- T - green.
- C - blue.
- G - yellow.

When zooming in at the nucleotide level, any mismatches between the read and reference are shown in black with a background color highlighting according to the Rasmol color scheme (see figure 24.13).



Figure 24.12: Mismatches between the reads and reference are shown as narrow vertical traits following the Rasmol color scheme.

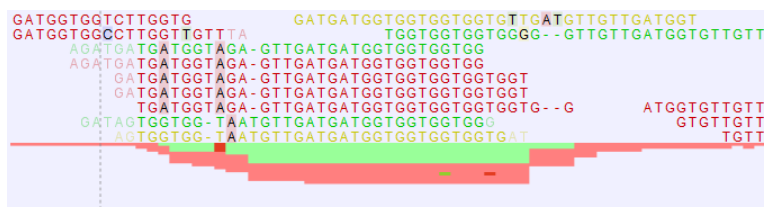

Figure 24.13: At the nucleotide level, mismatches between the reads and reference are shown in black with a Rasmol background color. The overflow graph below the reads shows how many more forward or reverse reads cannot be displayed in the track. Expand the tracks to see all reads at the nucleotide level.

At this level, usually more reads are mapped to the reference than can be shown in the track. In such cases the reads will be displayed in an overflow graph below the reads. The overflow graph is shown in the same colors as the sequences, and mismatches in reads are shown as horizontal lines following the Rasmol color scheme.

If your read mapping or track shows the message 'Too much data for rendering' on a grey background, simply zoom in to see your reads in more detail. This occurs when there are too many reads to be displayed clearly. More specifically, where there are more than 500,000 reads displayed in a reads track, more than 200,000 reads displayed in a read mapping, or when the region being viewed in a read mapping is longer than 200,000 bases. Paired reads count as one in these cases.

24.2.3 Reads track output from a read mapping

When the option "Create reads track" is chosen when running the tool "Map Reads to Reference", only the reads themselves will be saved. It is always possible to add information about the reference, consensus sequence or annotations later by creating a Track List. The main advantage of having the output of the read mapping process represented as a track is that this way it seamlessly integrates with other downstream analysis tools. So unless any specific functionality of the stand-alone read mapping is required, we recommend to use the tracks output for the additional flexibility in further analysis. Later it is possible to convert to and from tracks (see section 23.4).

The side-panel functionality for viewing a read track and an annotation track is shown in Figure 24.18.

An aggregated Reads Track is shown in figure 24.14. The three blue shades shown in the Reads Track represent the aggregated mapped reads. This is displayed when the amount of data in view reaches the data aggregation setting. Within the specified aggregation bucket, from top to bottom the blue colors mean:

- The maximum coverage value (read count).
- The average coverage value.
- The minimum coverage value.

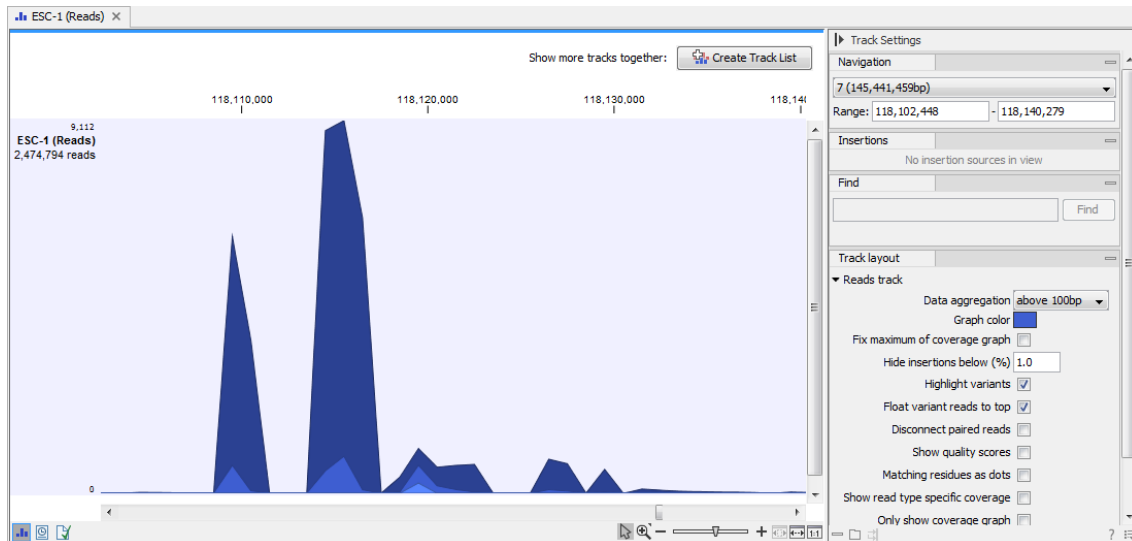

Figure 24.14: In the aggregated Reads Track, the three blue shades represent the aggregated mapped reads.

The data aggregation view is an alternative way of displaying a large amount of data (mapped reads) on the screen in order to shorten the data display time. This aggregated view allows you to navigate the view more smoothly and when used in combination with other tracks, this view can be used to get an overview of e.g. how many SNPs are located in a certain region.

In figure 24.15 we have zoomed in on a reads track (at the top showing the individual reads), with CDS and SNP annotations shown below.

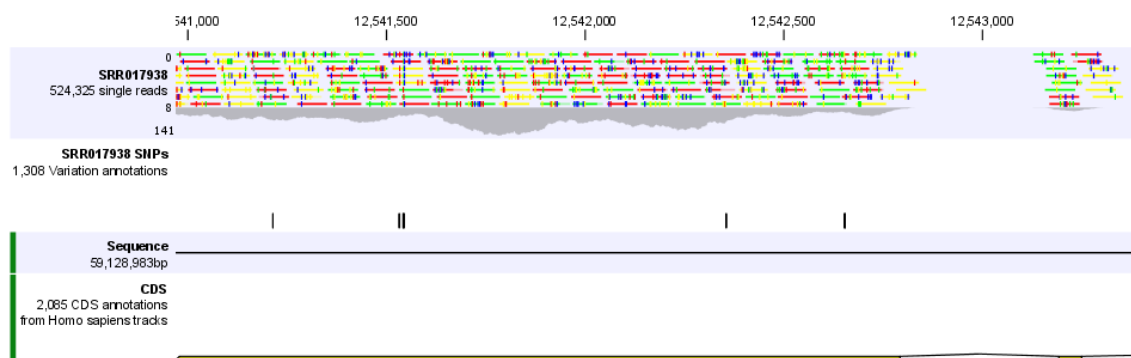

Figure 24.15: Zooming in on the tracks reveals details.

If you zoom in further the alignment of the reads and the reference sequence can be viewed at single nucleotide level (see figure 24.16).

In this case only three reads are visible. In order to see more reads, increase the height of the reads track by dragging down the lower part of the track with the mouse (Figure 24.17).

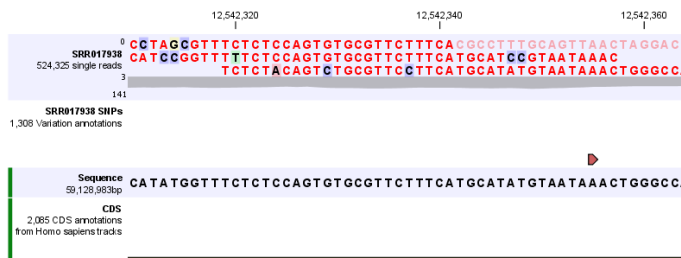

Figure 24.16: Zoom in to see the bases of the reads and the reference sequence.

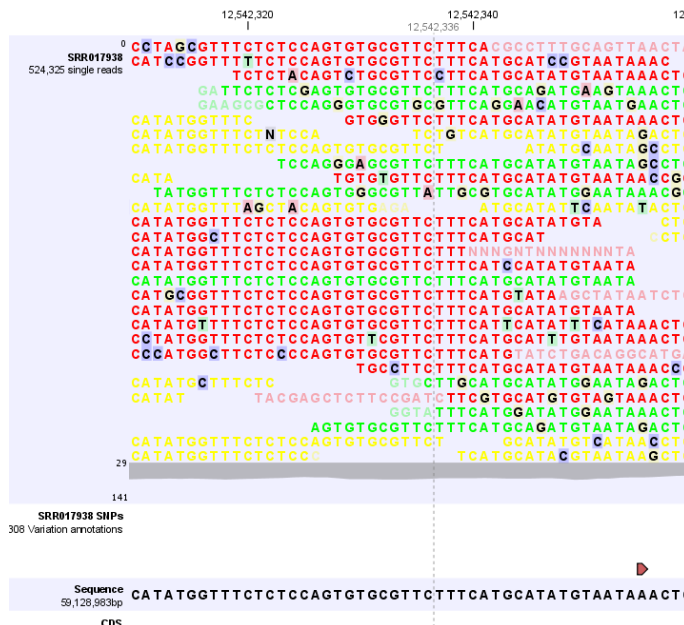

Figure 24.17: Adjusting the height of the track.

The options for the **Side Panel** vary depending on which track is shown in the View Area. In figure 24.18 an example is shown for a read mapping:

Navigation. Gives information about which chromosome is currently shown. Below this, you can see the start and end positions of the shown region of the chromosome. The drop-down list can be used to jump to a different chromosome. It is also possible to jump to a new position. This can be done by typing in the start and end positions in the text fields. Thousands separators are supported. The selected region will automatically appear in the viewing area.

Insertions. Only relevant for variant tracks.

Find. Not relevant for reads tracks.

Track layout. The options for the Track layout varies depending on which track type is shown. The options for a read track are:

- **Data aggregation.** Allows you to specify whether the information in the track should be shown in detail or whether you wish to aggregate data. By aggregating data you decrease the detail level but increase the speed of the data display process, which is of particular interest when working with big data sets. The threshold (in bp) for when data should be aggregated can be specified with the drop-down box. The threshold

describes the unit (or "bucket") size in base pairs, above which the data will start being aggregated. The bucket size depends on the track length and the zoom level. Hence, a data aggregation threshold with a low value will only show details when zoomed in, whereas a high value means that you can see details even when zoomed out. Please note that when using the high values, it will take longer time to display the data on the screen. Figure 24.18 shows the options for a read track and an annotation track. The data aggregation settings can be adjusted for each displayed track type.

- **Graph color.** Makes it possible to change the graph color.
- **Fix maximum of coverage graph.** Specifies the maximum coverage to be shown on the y-axis and makes the coverage on individual read tracks directly comparable with each other. Applies across all of the read mapping tracks.
- **Hide insertions below (%).** Hides insertions where the percentage of reads containing insertions is below this value. To hide all insertions, set this value to 101.
- **Highlight variants.** Variants are highlighted
- **Float variant reads to top.** When checked, reads with variations will appear at the top of the view.
- **Disconnect paired reads.** Disconnects paired end reads.
- **Show quality scores.** Shows the quality score. Ticking this option makes it possible to adjust the colors of the residues based on their quality scores. A quality score of 20 is used as default and will show all residues with a quality score of 20 or below in a blue color. Residues with quality scores above 20 will have colors that correspond to the selected color code. In this case residues with high quality scores will be shown in reddish colors. Clicking once on the color bar makes it possible to adjust the colors. Double clicking on the slider makes it possible to adjust the quality score limits. In cases where no quality scores are available, blue (the color normally used for residues with a low quality score) is used as default color for such residues.
- **Matching residues as dots.** Replaces matching residues with dots, only variants are shown in letters.
- **Show read type specific coverage.** When enabled, the coverage graph that summarizes those reads that could not be explicitly shown is now replaced by one coverage graph for each read type found in the Reads track. The read types graphs are made transparent so that the overlap can be visible when graphs are rendered on top of each other. This option can for instance be used for easy and visual comparison of the strand specific coverage.
- **Only show coverage graph.** When enabled, only the coverage graph is shown and no reads are shown.
- **Highlight reverse paired reads.** When enabled, read pairs with reverse orientation are highlighted with a light blue color.

When working with other track types such as gene tracks, other options are available:

Labels. Controls where in relation to the annotation features the labels will be shown, i.e. **Flag** places a label at the beginning of the gene, and above the feature graphics as shown in figure 24.19.

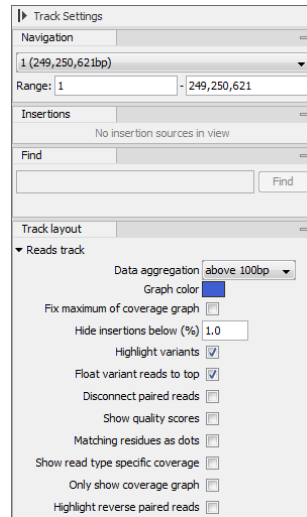

Figure 24.18: The Side Panel for reads tracks.

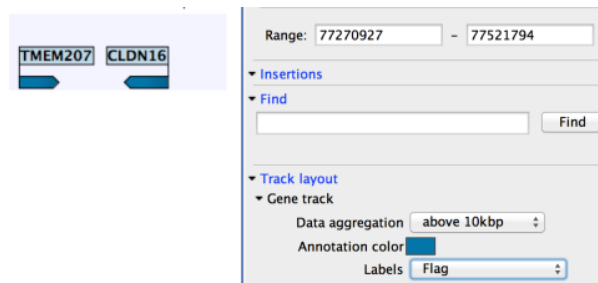

Figure 24.19: The Side Panel for annotation tracks.

24.2.4 Stand-alone read mapping

Reads can be mapped to linear and circular chromosomes. Read mappings to circular genomes are visualized linearly as shown in figure 24.20.



Figure 24.20: Mapping reads to a circular chromosome. Reads that are marked with double arrows at the ends are reads that map across the starting point of the sequence. The arrows indicate that the alignment continues at the other end of the reference sequence.

Reads that map across the starting point of the sequence are shown both at the start and end of the reference sequence. Such reads are marked with >> at the end of the read to indicate that

the alignment continues at the other end of the reference sequence.

Mapping results can either be tracks (📊) (see chapter 23) or mapping tables (📄) or single mappings (📄). This section explains more about the latter two.

Note: If your read mapping or track shows the message 'Too much data for rendering' on a grey background, simply zoom in to see your reads in more detail. This occurs when there are too many reads to be displayed clearly. More specifically, where there are more than 500,000 reads displayed in a reads track, more than 200,000 reads displayed in a read mapping, or when the region being viewed in a read mapping is longer than 200,000 bases. Paired reads count as one in these cases.

24.2.5 Mapping table

When several reference sequences are used or you are performing *de novo* assembly with the reads mapped back to the contig sequences, all your mapping data will be accessible from a table (📄). It means that all the individual mappings are treated as one single file to be saved in the **Navigation Area** as a table.

An example of a mapping table for a *de novo* assembly is shown in figure 24.21.

Name	Consensus length	Total read count	Average coverage	Reference sequence	Reference length
1 mapping	29594383	35647839	47,24	1	39427671
2 mapping	19301838	30548891	62,03	2	19698289
3 mapping	22939382	36398908	62,16	3	23459830
4 mapping	18114273	25832440	55,78	4	18585056
5 mapping	26413673	36836356	54,76	5	26975502
Mt mapping	361460	2551503	263,59	Mt	366924
Pt mapping	154490	23137498	6,074,88	Pt	154478

Figure 24.21: The mapping table.

The information included in the table is:

- **Name.** When mapping reads to a reference, this will be the name of the reference sequence.
- **Consensus length.** The length of the consensus sequence. Subtracting this from the length of the reference will indicate how much of the reference that has not been covered by reads.
- **Total read count.** The number of reads. Reads with multiple hits on different reference sequences are placed according to your input for **Non-specific matches**
- **Average coverage.** This is simply summing up the bases of the aligned part of all the reads divided by the length of the reference sequence.

- **Reference sequence.** The name of the reference sequence.
- **Reference length.** The length of the reference sequence.

An example of a contig table produced by mapping reads to a reference is shown in figure 24.22. The read mappings use information from the reference sequences that were used as input.

Name	Consensus length	Total read count	Average coverage
ERSO25626_Arabidopsis-thaliana_Illumina-Ge...	56576	68189	48,48
ERSO25626_Arabidopsis-thaliana_Illumina-Ge...	7494	9571	51,64
ERSO25626_Arabidopsis-thaliana_Illumina-Ge...	40991	51224	50,00
ERSO25626_Arabidopsis-thaliana_Illumina-Ge...	18714	24953	53,19
ERSO25626_Arabidopsis-thaliana_Illumina-Ge...	4436	5158	47,00
ERSO25626_Arabidopsis-thaliana_Illumina-Ge...	444	1174	104,86
ERSO25626_Arabidopsis-thaliana_Illumina-Ge...	318	399	48,66
ERSO25626_Arabidopsis-thaliana_Illumina-Ge...	63200	79841	50,70
ERSO25626_Arabidopsis-thaliana_Illumina-Ge...	17983	25306	56,06
ERSO25626_Arabidopsis-thaliana_Illumina-Ge...	11195	13874	49,81
ERSO25626_Arabidopsis-thaliana_Illumina-Ge...	61270	79020	51,65
ERSO25626_Arabidopsis-thaliana_Illumina-Ge...	260	206	29,35
ERSO25626_Arabidopsis-thaliana_Illumina-Ge...	856	833	40,48
ERSO25626_Arabidopsis-thaliana_Illumina-Ge...	38475	42955	45,72
ERSO25626_Arabidopsis-thaliana_Illumina-Ge...	3287	4102	52,14
ERSO25626_Arabidopsis-thaliana_Illumina-Ge...	151399	198332	52,10
ERSO25626_Arabidopsis-thaliana_Illumina-Ge...	12112	14707	48,78
ERSO25626_Arabidopsis-thaliana_Illumina-Ge...	80673	105777	51,96
ERSO25626_Arabidopsis-thaliana_Illumina-Ge...	8695	11699	53,28
ERSO25626_Arabidopsis-thaliana_Illumina-Ge...	60241	79204	51,61

Figure 24.22: The contig table.

In addition to the information found in the *de novo* table, the mapping table also provides information about name, common name and Latin name of each reference sequence.

At the bottom of the table there are three buttons that can be used to open or extract sequences. Select the relevant rows (press Ctrl + A - ⌘ +A on Mac - to select all) before clicking on the buttons:

- **Open Mapping.** Opens the read mapping for visual inspection. You can also open one mapping simply by double-clicking in the table.
- **Extract Consensus/Contigs.** For *de novo* assembly results, the contig sequences will be extracted. For results when mapping against a reference, the **Extract Consensus** tool will be used (see section 24.8).
- **Extract Subset.** Creates a new mapping table with the mappings that you have selected.

You can copy the textual information from the table by selecting in the table and click **Copy** (⌘). This can then be pasted into e.g. Excel. You can also export the table in Excel format.

24.2.6 Mapping view settings

When you open a single mapping, there are many viewing options available in the **Side Panel** for customizing the layout (see section 19.2). We cover here the ones relevant to review read mapping results.

- **Read layout.** This section appears at the top of the **Side Panel** when viewing a stand alone read mapping:

- **Compactness.** The compactness setting options let you control the level of detail to be displayed. This setting affects many of the other settings in the **Side Panel** as well as the general behavior of the view. For example: if the compactness is set to **Compact**, you will not be able to see quality scores or annotations on the reads, even if these are turned on via the Nucleotide info section of the Side Panel. You can change the Compactness setting in the Side Panel directly, or you can use the shortcut: press and hold the Alt key while you scroll with the mouse wheel or touchpad.
 - * **Not compact.** This allows the mapping to be viewed in full detail, including quality scores and trace data for the reads, where this is relevant. To view such information, additional viewing options under the **Nucleotide info** view settings must also be selected. For further details on these, please see section 17.1.2 and section 10.1.
 - * **Low.** Hides trace data, quality scores and puts the reads' annotations on the sequence.
 - * **Medium.** The labels of the reads and their annotations are hidden, and the residues of the reads cannot be seen.
 - * **Compact.** Even less space between the reads.
 - * **Packed.** All the other compactness settings will stack the reads on top of each other, but the packed setting will use all space available for displaying the reads. When zoomed in to 100%, you can see the residues but when zoomed out the reads will be represented as lines just as with the Compact setting. The packed mode is very useful when viewing large amounts of data. However certain functionality possible with other views are not available in packed view. For example, no editing of the read mapping or selections of it can be done and color coding changes are not possible. An example of the packed setting is shown in figure 24.23.

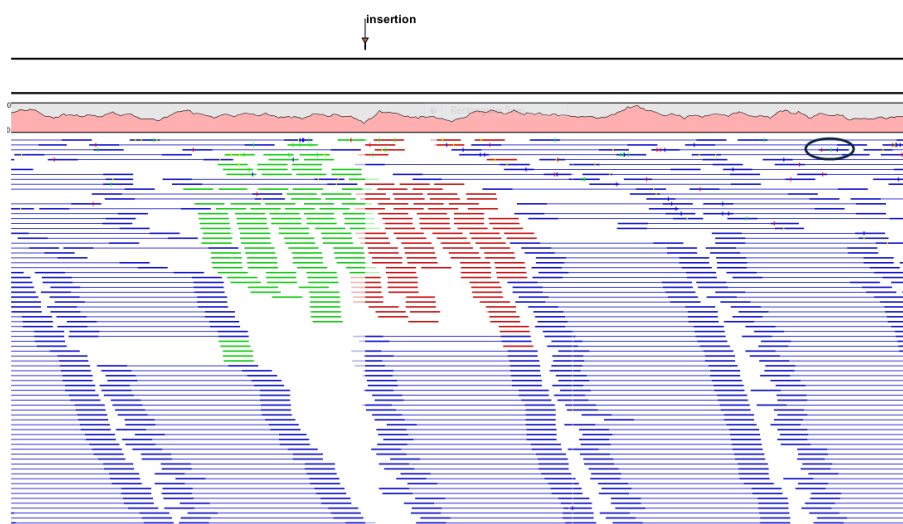

Figure 24.23: An example of the packed compactness setting. We highlighted in black an example of 3 narrow vertical lines representing mismatching residues.

- **Gather sequences at top.** Enabling this option affects the view that is shown when scrolling horizontally. If selected, the sequence reads which did not contribute to the visible part of the mapping will be omitted whereas the contributing sequence reads will automatically be placed right below the reference. This setting is not relevant when the compactness is packed.

- **Show sequence ends.** Regions that have been trimmed are shown with faded traces and residues. This illustrates that these regions have been ignored during the assembly.
 - **Show mismatches.** When the compactness is packed, you can highlight mismatches which will get a color according to the Rasmol color scheme. A mismatch is whenever the base is different from the reference sequence at this position. This setting also causes the reads that have mismatches to be floated at the top of the view.
 - **Disconnect paired reads.** This option will break up the paired reads in the display (they are still marked as pairs - this just affects the visualization). The reads are marked with colors for the direction (default red and green) instead of the color for pairs (default blue). This is particularly useful when investigating overlapping pairs in packed view and when the strand / read orientation is important.
 - **Packed read height.** When the compactness is set to "packed", you can choose the height of the visible reads. When there are more reads than the height specified, an overflow graph will be displayed below the reads. The overflow graph is shown in the same colors as the sequences, and mismatches in reads are shown as narrow vertical lines (see figure 24.23). The colors of the small lines represent the mismatching residue. The color codes for the horizontal lines correspond to the color used for highlighting mismatches in the sequences (red = A, blue = C, yellow = G, and green = T), meaning that a red line with half the height of the blue part of the overflow graph will represent a mismatching "A" in half of the paired reads at this particular position.
 - **Find Conflict.** Clicking this button selects the next position where there is a conflict between the sequence reads. Residues that are different from the reference are colored (as default), providing an overview of the conflicts. Since the nextF conflict is automatically selected it is easy to make changes. You can also use the Space key to find the next conflict.
 - **Low coverage threshold.** All regions with coverage up to and including this value are considered low coverage. When clicking the 'Find low coverage' button the next region in the read mapping with low coverage will be selected.
- **Alignment info.** There is one additional parameter:
 - **Coverage:** Shows how many sequence reads that are contributing information to a given position in the mapping. The level of coverage is relative to the overall number of sequence reads.
 - * **Foreground color.** Colors the letters using a gradient, where the left side color is used for low coverage and the right side is used for maximum coverage.
 - * **Background color.** Colors the background of the letters using a gradient, where the left side color is used for low coverage and the right side is used for maximum coverage
 - * **Graph.** The coverage is displayed as a graph (Learn how to export the data behind the graph in section 6.7).
 - **Height.** Specifies the height of the graph.
 - **Type.** The graph can be displayed as Line plot, Bar plot or as a Color bar.
 - **Color box.** For Line and Bar plots, the color of the plot can be set by clicking the color box. If a Color bar is chosen, the color box is replaced by a gradient color box as described under Foreground color.

- **Residue coloring.** There is one additional parameter:
 - **Sequence colors.** This option lets you use different colors for the reads.
 - * **Main.** The color of the consensus and reference sequence. Black per default.
 - * **Forward.** The color of forward reads (single reads). Green per default.
 - * **Reverse.** The color of reverse reads (single reads). Red per default.
 - * **Paired.** The color of paired reads. Blue per default. Note that reads from **broken pairs** are colored according to their Forward/Reverse orientation or as a Non-specific match, but with a darker nuance than ordinary single reads.
 - * **Non-specific matches.** When a read would have matched equally well another place in the mapping, it is considered a non-specific match. This color will "overrule" the other colors. Note that if you are mapping with several reference sequences, a read is considered a double match when it matches more than once *across all the contigs/references*. A non-specific match is yellow per default.

- **Sequence layout.** At the top of the **Side Panel**:
 - **Matching residues as dots** Matching residues will be presented as dots. Only the top sequence will be preserved in its original format.

24.2.7 Overlapping paired reads

Depending on the sequencing protocol paired reads may overlap. If the mates of an overlapping pair disagree on one or more positions (e.g. due to sequencing errors) the viewer will represent this as a paired read with either NNN's (gap) or a IUPAC code inserted. This reflects the way the Workbench variant callers would treat disagreements - if two overlapping reads do not agree about the variant base, they are both ignored. If you wish to inspect the mates of overlapping pairs you can check the side panel option 'Disconnect paired reads'. An example is shown in figure 24.24.

24.2.8 Find broken pair mates

The **Find Broken Pair Mates** tool is not applicable to tracks, but is available only to stand-alone read mappings.

Figure 24.25 shows an example of a read mapping with paired reads (shown in blue). In this particular region, there are some broken pairs (red and green reads). Pairs are marked as broken if the respective orientation or distance between the reads is not right (see general info on handling paired data in section 6.3.9), or if one of the reads do not map at all.

In some situations it is useful to investigate where the mate of the broken pairs map. This would indicate genomic rearrangements, mis-assemblies of de novo assembly etc. In order to see this, select the region in question on the reference sequence, right-click and choose **Find Broken Pair Mates**.

This will open the dialog shown in figure 24.26.

The purpose of this dialog is to let you specify if you want to annotate the resulting broken pair overview with annotation information. In this case, you would see if there are any overlapping genes at the position of the mates.

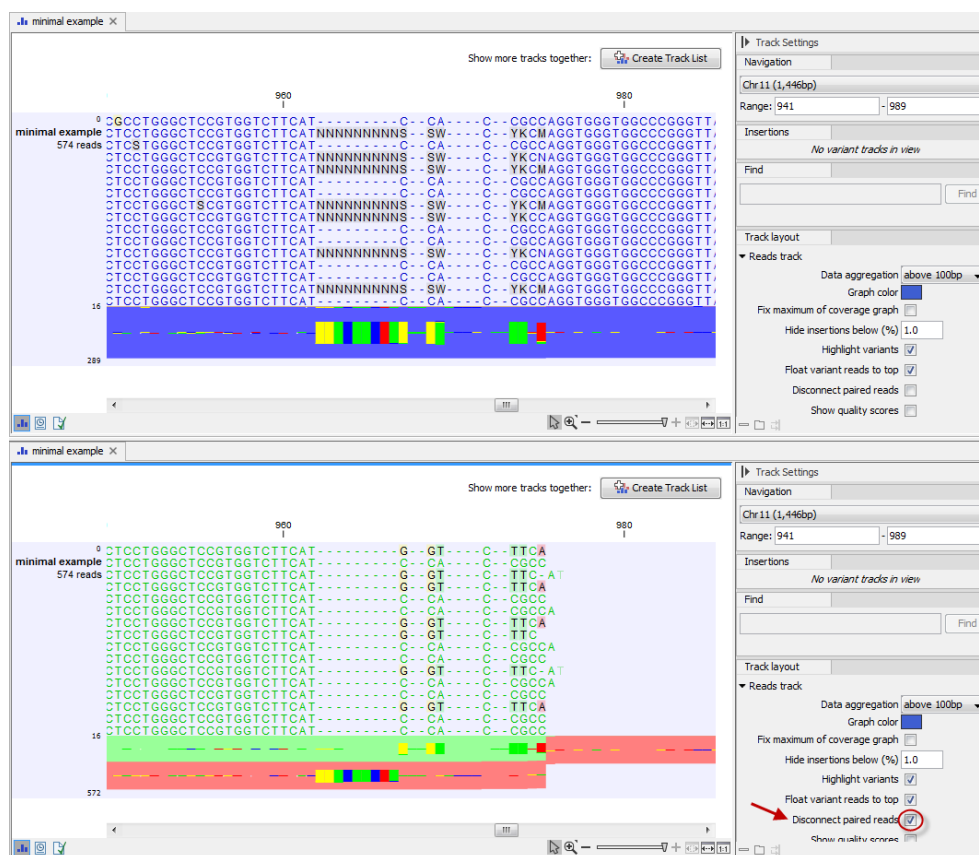

Figure 24.24: Overlapping paired reads containing discrepancies in the overlapping region. The divergent area in the overlapping read pair is marked with N's and IUPAC codes in the top part of the figure. Disconnecting the paired reads by ticking the box "Disconnect Paired Reads" in the Side Panel allows you to see the individual reads.

In addition, the dialog provides an overview of the broken pairs that are contained in the selection.

Click **Next** and **Finish**, and you will see an overview table as shown in figure 24.27.

The table includes the following information for both parts of the pair:

Reference The name of the reference sequence where it is mapped

Start and end The position on the reference sequence where the read is aligned

Match count The number of possible matches for the read. This value is always 1, unless the read is a non-specific match (marked in yellow)

Annotations Shows a list of the overlapping annotations, based on the annotation type selected in figure 24.26.

You can select some or all of these broken pairs and extract them as a sequence list for further analysis by clicking the **Create New Sequence List** button at the bottom of the view.

24.3 Mapping reports

You can create two kinds of reports regarding read mappings and de novo assemblies: *First*,

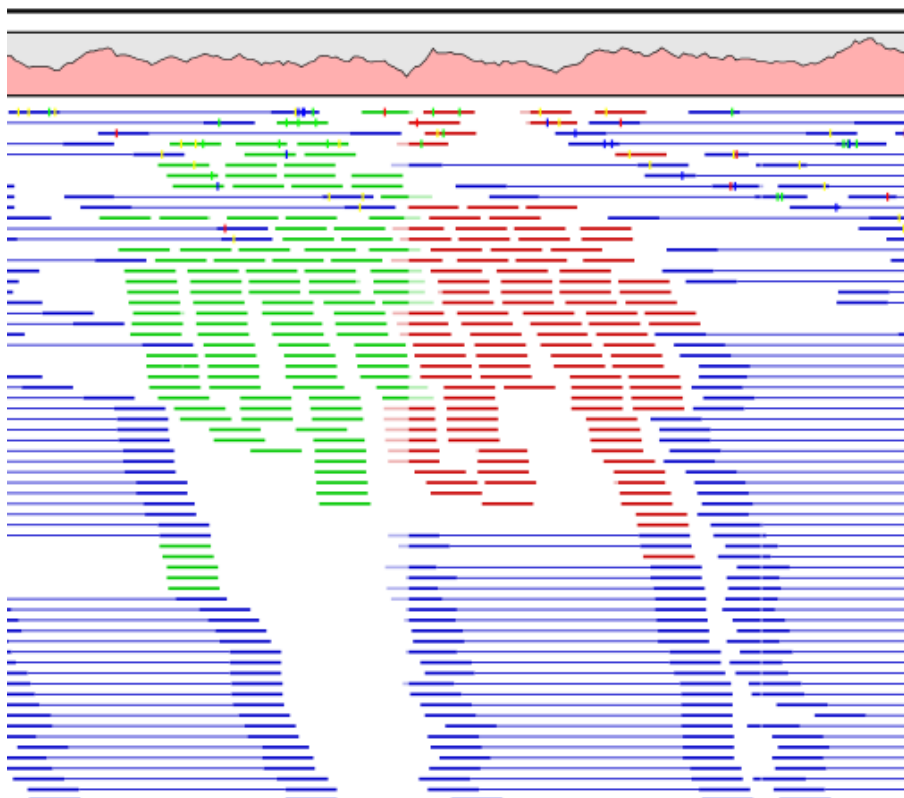

Figure 24.25: *Broken pairs.*

you can choose to generate a summary report about the mapping process itself (see section 24.2.2). *Second*, you can generate a detailed statistics report after the mapping or assembly has finished. This report is useful if you want to generate statistics across results made in different processes, and it generates more detailed statistics than the summary mapping report. Both reports are described below.

See section section 28.1.13 for more information about de novo assembly reports.

24.3.1 Summary mapping report

If you choose to create a report as part of the read mapping (see section 24.2.2), this report will summarize the results of the mapping process. An example of a report is shown in figure 24.28

The information included in the report is:

- **Summary statistics.** A summary of the mapping statistics:
 - **Reads.** The number of reads and the average length.
 - **Mapped.** The number of reads that are mapped and their average length.
 - **Not mapped.** The number of reads that do not map and their average length.
 - **References.** Number of reference sequences.
- **Parameters.** The settings used are reported for the process as a whole and for each sequence list used as input.

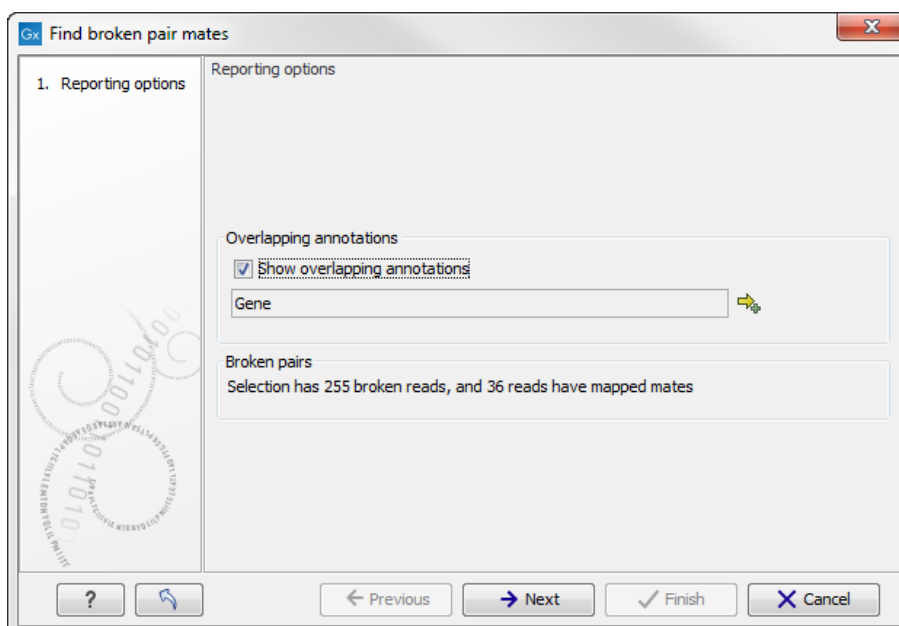

Figure 24.26: Finding the mates of broken pairs.

...	Start	End	Matc...	Anno...	...	Start	End	Match count	Annotations
...	101	136	1	-	...	4686047	4686082	1	yjtD
...	93	128	1	-	...	4686048	4686083	1	yjtD
...	101	136	1	-	...	4686050	4686085	1	yjtD
...	92	127	1	-	...	4686053	4686088	1	yjtD
...	86	121	1	-	...	4686054	4686089	1	yjtD
...	97	132	1	-	...	4686054	4686089	1	yjtD
...	90	125	1	-	...	4686059	4686094	1	yjtD
...	109	144	1	-	...	4686061	4686096	1	yjtD
...	103	138	1	-	...	4686062	4686097	1	yjtD
...	99	134	1	-	...	4686065	4686100	1	yjtD
...	104	139	1	-	...	4686065	4686100	1	yjtD
...	113	148	1	-	...	4686066	4686101	1	yjtD
...	114	149	1	-	...	4686066	4686101	1	yjtD
...	110	145	1	-	...	4686067	4686102	1	yjtD

Figure 24.27: An overview of the broken pairs.

- **Distribution of read length.** For each sequence length, you can see the number of reads and the distribution in percent. This is mainly useful if you don't have too much variance in the lengths as you have in e.g. Sanger sequencing data.
- **Distribution of matched reads lengths.** Equivalent to the above, except that this includes only the reads that have been matched to a contig.
- **Distribution of non-matched reads lengths.** Show the distribution of lengths of the rest of the sequences.

You can copy the information from the report by selecting in the report and click **Copy** (📄). You can also export the report in Excel format.

1 Mapping summary report

1.1 Summary statistics

	Count	Percentage of reads	Average length	Number of bases	Percentage of bases
References	1	-	20,158.00	20,158	-
Mapped reads	1,000	99.80%	76.00	76,000	99.89%
Not mapped reads	2	0.20%	40.00	80	0.11%
Reads in pairs	996	99.40%	250.00	75,696	99.50%
Broken paired reads	4	0.40%	76.00	304	0.40%
Total reads	1,002	100.00%	75.93	76,080	100.00%

1.2 Distribution of read length

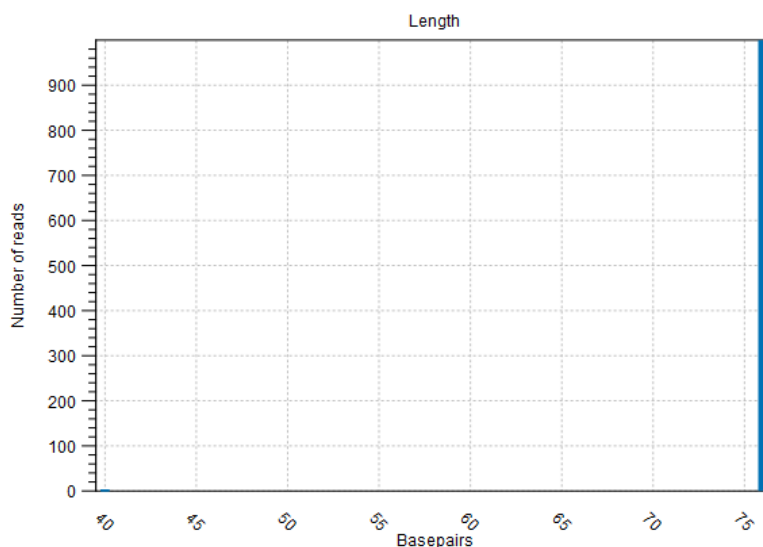

Figure 24.28: The summary mapping report.

24.3.2 Detailed mapping report

Note that this tool can be used to create a detailed report on a read mapping or a de novo assembly.

To create a detailed mapping report:

Toolbox | NGS Core Tools (📁) | Create Detailed Mapping Report (📄)

This opens a dialog where you can select mapping results (📄)/ (📄)/ (📄) or RNA-Seq analysis results (📄).

Clicking **Next** will display the dialog shown in figure 24.29

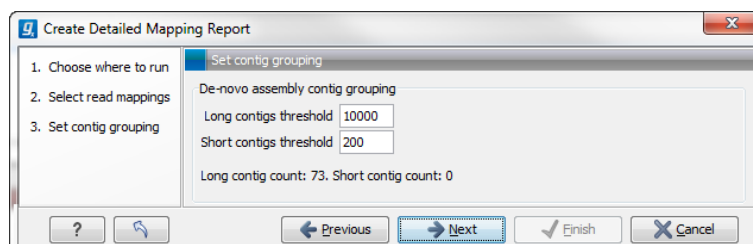

Figure 24.29: Parameters for mapping reports.

In the next wizard window "Set contig group", you can set thresholds for grouping long and short contigs. The grouping is used to show statistics like number of contigs, mean length etc. for the contigs in each group. Thresholds can only be specified for de novo assemblies that do not have a consensus sequence, i.e., these options are disabled whenever a consensus sequence is present or if you are working with a read mapping. Note that the de novo assembly in the *CLC Genomics Workbench* per default only reports contigs longer than 200 bp (this can be changed when running the assembly).

Click **Next** to select output options as shown in figure 24.30

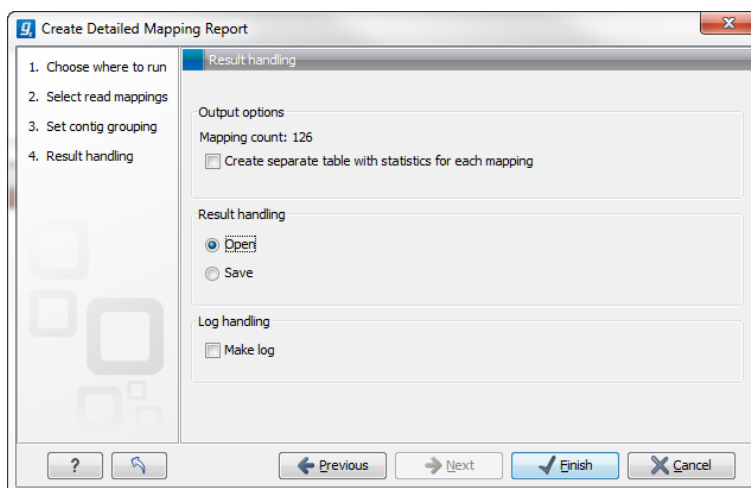

Figure 24.30: Result handling options.

By checking **Create table with statistics for each mapping**, you can create a table showing detailed statistics for each reference sequence (for de novo results the contigs act as reference sequences, so it will be one row per contig).

The first section of the detailed report is a summary of the statistics: reference count, type, total reference length, GC contents in %, total read count, mean read length, and total read length

- Reference count
- Type
- Total reference length
- GC contents in %
- Total read count
- Mean read length
- Total read length

The rest of the report, as well as the optional statistic tables are described in the following sections.

References

The second section of the detailed report concerns the Reference sequence(s).

First, a table gives information about **Reference coverage**, including coverage statistics and GC content of the reference sequence.

The second table gives **Coverage statistics**. A position on the reference is counted as "covered" when at least one read is aligned to it. Note that unaligned ends (faded nucleotides at the ends) that are produced when mapping using local alignment do not contribute to the coverage. Also, positions with an ambiguous nucleotide in the reference (i.e., not A, C, T or G) count as zero coverage regions, regardless of the number of reads mapping across them.

In the example shown in figure 24.31, there is a region of zero coverage in the middle and one time coverage on each side. Note that the gaps to the very right are within the same read which means that these two positions on the reference sequence are still counted as "covered".

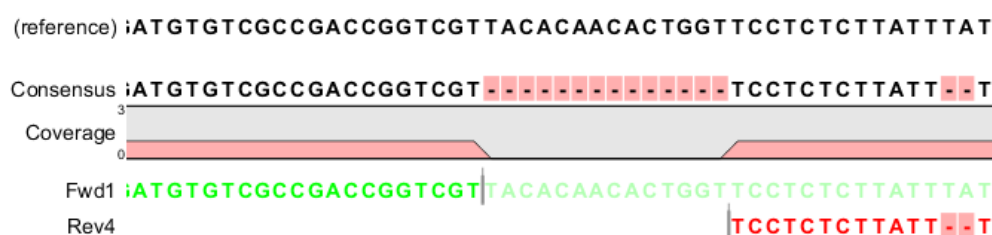

Figure 24.31: A region of zero coverage in the middle and one time coverage on each side. Note that the gaps to the very right are within the same read which means that these two positions on the reference sequence are still counted as "covered".

In this table, coverage is reported on two levels: including and excluding zero coverage regions. In some cases, you do not expect the whole reference to be covered, and only the coverage levels of the covered parts of the reference sequence are interesting. On the other hand, if you have sequenced the full genome that you use as reference, the overall coverage is probably the most relevant number (i.e. including zero coverage regions).

In the third and fourth subsections, two graphs display **Coverage level distribution**, with and without zero coverage regions. Two bar plots show the distribution of coverage with coverage level on the x-axis and number of positions with that coverage on the y-axis (as seen in figure 24.32).

The graph to the left shows all the coverage levels, whereas the graph to the right shows coverage levels within 3 standard deviations from the mean. The reason for this is that for complex genomes, you will often have a few regions with extremely high coverage which will affect the resolution of the graph, making it impossible to see the coverage distribution for the majority of the references. These coverage outliers are excluded when only showing coverage within 3 standard deviations from the mean. Below the second coverage graph there are some statistics on the data that is outside the 3 standard deviations.

Subsection 5 gives some statistics on the **Zero coverage regions**; the number, minimum and maximum length, mean length, standard deviation, and total length.

One of the biases seen in sequencing data concerns GC content. Often there is a correlation

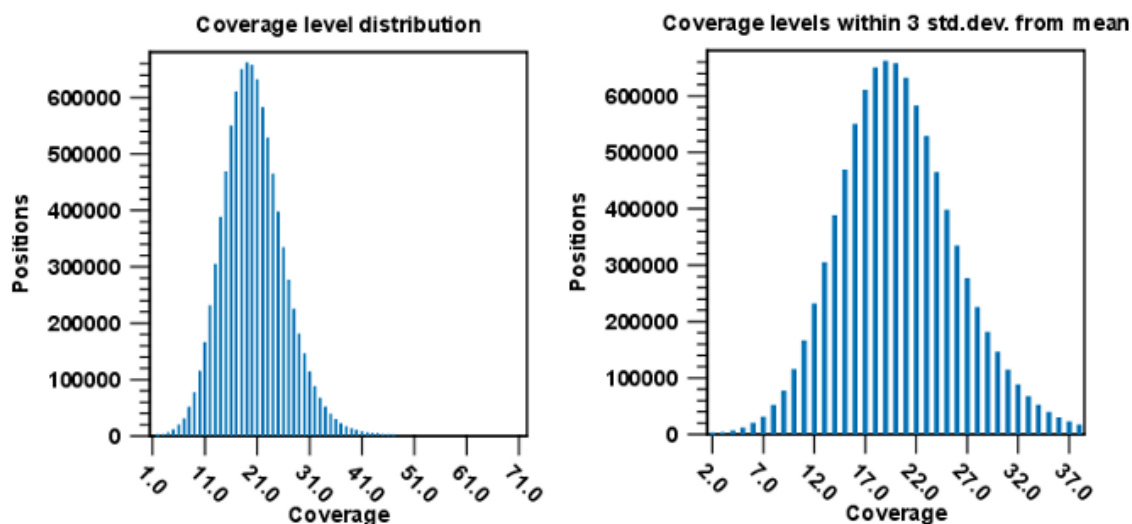

Figure 24.32: Distribution of coverage - to the left for all the coverage levels, and to the right for coverage levels within 3 standard deviations from the mean.

between GC content and coverage. In order to investigate this correlation, the report includes in subsection 6 a **Coverage versus GC Content** graph plotting coverage against GC content (see figure 24.33). Note that you can see the GC content for each reference sequence in the table(s) above.

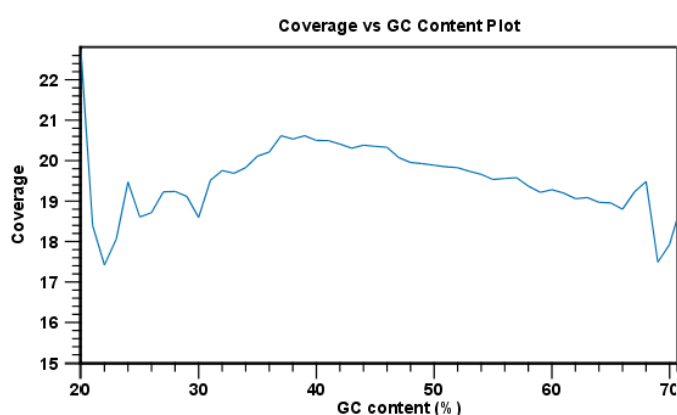

Figure 24.33: The plot displays, for each GC content level (0-100 %), the mean read coverage of 100bp reference segments with that GC content.

The plot displays, for each GC content level (0-100 %), the mean read coverage of 100bp reference segments with that GC content.

For a report created from a de novo assembly, this section finishes with statistics about the reads which are the same for both reference and de novo assembly (see section 24.2.8 below).

Read statistics

This section contains simple statistics for **all mapped reads**, **non-specific matches** (reads that match more than place during the assembly), **non-perfect matches** (reads with one or more mismatches or gaps relative to the reference sequence) and **paired reads**.

Note! Paired reads are counted as two, even though they form one pair. The section on paired reads also includes information about paired distance and counts the number of pairs that were broken due to:

- Wrong distance: When starting the mapping, a distance interval is specified. If the reads during the mapping are placed outside this interval, they will be counted here.
- Mate inverted: If one of the reads has been matched as reverse complement, the pair will be broken (note that the pairwise orientation of the reads is determined during import).
- Mate on other contig: If the reads are placed on different contigs, the pair will also be broken.
- Mate not matched: If only one of the reads match, the pair will be broken as well.

Each subsection contains a table that recapitulates the read count, % of all mapped reads, mean read length and total read length, and for some sections two graphs showing the distribution of match specificity or the distribution of mismatches.

Note that for the section concerning paired reads (see figure 24.34), the distance includes both the read sequence and the insert between them as explained in section 6.3.9.

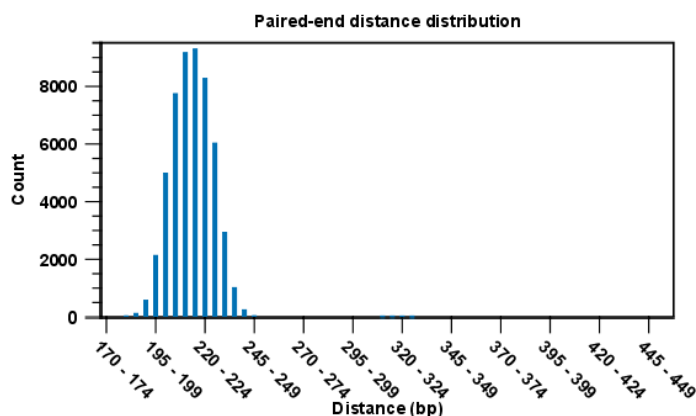

Figure 24.34: A bar plot showing the distribution of distances between intact pairs.

The following subsections give graphs showing **read length distribution**, **insertion length distribution**, **deletion length distribution**. Two plots of the distribution of insertion and deletion lengths can be seen in figure 24.35 and figure 24.36.

Nucleotide differences in reads relative to a reference gives the percentage of read bases that differ with the reference for all base pairs and a deletion. In the **Nucleotide mapping** section two tables give the counts and percentages of differences between the reads and the reference for each base. Graphs display the relative errors and errors counts between reads to reference and reference to reads, i.e., which bases in the reference are substituted to which bases in the

reads. This information is plotted in different ways with an example shown here in figure 24.35.

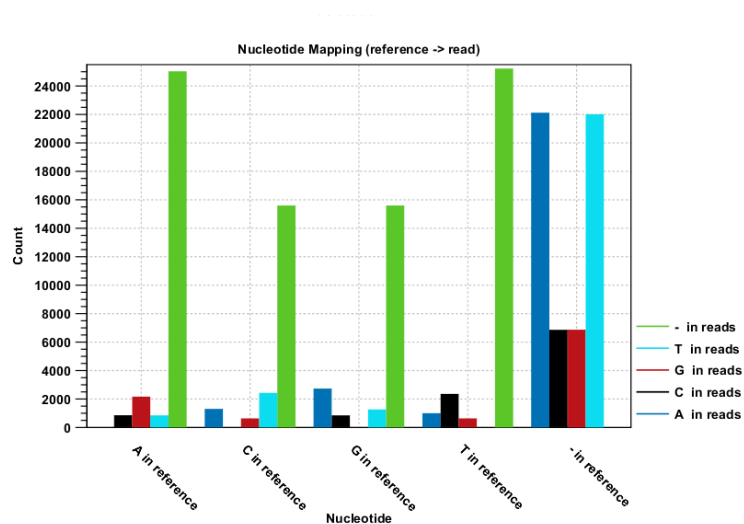

Figure 24.35: The As and Ts are more often substituted with a gap in the sequencing reads than C and G.

This example shows for each type of base in the reference sequence, which base (or gap) is found most often. Please note that only mismatches are plotted - the matches are not included. For example, an A in the reference is more often replaced by a G than any other base.

Below these plots, there are two plots of the **quality values for matches** and **quality values for mismatches**. Next, there is a plot of the mismatch fraction for each read position. Typically with quality dropping towards the end of a read, there will be more mismatches towards the end as the example in figure 24.36 shows.

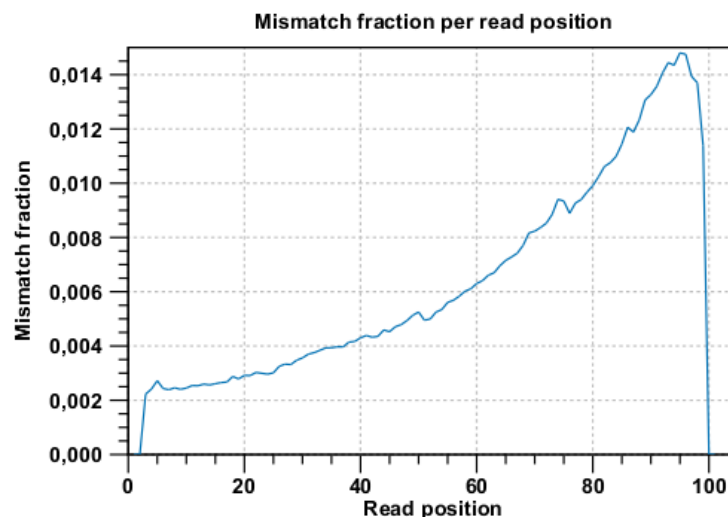

Figure 24.36: There are mismatches towards the end of the reads.

The last plots section deals with unaligned read lengths.

Statistics table for each mapping

By checking **Create table with statistics for each mapping**, a table showing detailed statistics for each reference sequence will be generated (figure 24.37).

Contig	Reference name	Reference length	Mapped reads	Forward reads	Reversed reads	Reads in aligned pairs	Reads in broken pairs
Mate-pair trimmed (paired) contig 1 mapping	Mate-pair trimmed (paired) contig 1	598431	581188	290527	290661	468898	78160
Mate-pair trimmed (paired) contig 2 mapping	Mate-pair trimmed (paired) contig 2	662986	795762	380307	379455	617740	102074
Mate-pair trimmed (paired) contig 3 mapping	Mate-pair trimmed (paired) contig 3	1276788	1342117	671880	670237	1093648	184842
Mate-pair trimmed (paired) contig 4 mapping	Mate-pair trimmed (paired) contig 4	1942568	2080079	1038727	1041352	1691292	298464
Mate-pair trimmed (paired) contig 5 mapping	Mate-pair trimmed (paired) contig 5	213874	252017	125918	126099	202202	34458
Mate-pair trimmed (paired) contig 6 mapping	Mate-pair trimmed (paired) contig 6	38337	38976	19380	19495	30344	5052
Mate-pair trimmed (paired) contig 7 mapping	Mate-pair trimmed (paired) contig 7	212765	256420	128226	128194	207388	33970
Mate-pair trimmed (paired) contig 8 mapping	Mate-pair trimmed (paired) contig 8	409328	465796	232601	233195	378052	63940
Mate-pair trimmed (paired) contig 9 mapping	Mate-pair trimmed (paired) contig 9	1288	1851	963	918	790	174
Mate-pair trimmed (paired) contig 10 mapping	Mate-pair trimmed (paired) contig 10	387450	457494	228976	228518	373258	59520
Mate-pair trimmed (paired) contig 11 mapping	Mate-pair trimmed (paired) contig 11	49201	55290	27653	27637	43492	7128
Mate-pair trimmed (paired) contig 12 mapping	Mate-pair trimmed (paired) contig 12	106203	123969	61892	62077	99770	16100
Mate-pair trimmed (paired) contig 13 mapping	Mate-pair trimmed (paired) contig 13	68610	78671	39339	39322	62656	10516
Mate-pair trimmed (paired) contig 14 mapping	Mate-pair trimmed (paired) contig 14	65386	70202	35004	35198	55002	9334
Mate-pair trimmed (paired) contig 15 mapping	Mate-pair trimmed (paired) contig 15	2302	2806	1381	1425	1060	292
Mate-pair trimmed (paired) contig 16 mapping	Mate-pair trimmed (paired) contig 16	23999	25364	12701	12663	19600	3306
Mate-pair trimmed (paired) contig 17 mapping	Mate-pair trimmed (paired) contig 17	1541	2275	1126	1149	962	132
Mate-pair trimmed (paired) contig 18 mapping	Mate-pair trimmed (paired) contig 18	57004	55769	27978	27791	43332	7260
Mate-pair trimmed (paired) contig 19 mapping	Mate-pair trimmed (paired) contig 19	1212	1425	779	646	600	162
Mate-pair trimmed (paired) contig 20 mapping	Mate-pair trimmed (paired) contig 20	28480	31189	15642	15547	24172	4006
Mate-pair trimmed (paired) contig 21 mapping	Mate-pair trimmed (paired) contig 21	2974	6969	3544	3425	2848	760
Mate-pair trimmed (paired) contig 22 mapping	Mate-pair trimmed (paired) contig 22	67758	79208	39445	39763	62998	10464
Mate-pair trimmed (paired) contig 23 mapping	Mate-pair trimmed (paired) contig 23	3141	6602	3261	3341	2910	746
Mate-pair trimmed (paired) contig 24 mapping	Mate-pair trimmed (paired) contig 24	5545	33388	16533	16655	21670	4220
Mate-pair trimmed (paired) contig 25 mapping	Mate-pair trimmed (paired) contig 25	1076	567	282	285	604	22
Mate-pair trimmed (paired) contig 26 mapping	Mate-pair trimmed (paired) contig 26	5741	6156	3086	3070	3814	748
Mate-pair trimmed (paired) contig 27 mapping	Mate-pair trimmed (paired) contig 27	2198	2334	1205	1129	886	290
Mate-pair trimmed (paired) contig 28 mapping	Mate-pair trimmed (paired) contig 28	3725	6807	3306	3501	3090	838
Mate-pair trimmed (paired) contig 29 mapping	Mate-pair trimmed (paired) contig 29	1611	1790	941	849	748	188
Mate-pair trimmed (paired) contig 30 mapping	Mate-pair trimmed (paired) contig 30	2035	821	413	408	564	50
Mate-pair trimmed (paired) contig 31 mapping	Mate-pair trimmed (paired) contig 31	1402	1447	731	716	594	120
Mate-pair trimmed (paired) contig 32 mapping	Mate-pair trimmed (paired) contig 32	5372	9729	4906	4923	5646	1174
Mate-pair trimmed (paired) contig 33 mapping	Mate-pair trimmed (paired) contig 33	1468	544	273	271	372	22
Mate-pair trimmed (paired) contig 34 mapping	Mate-pair trimmed (paired) contig 34	1222	1283	650	633	490	122
Mate-pair trimmed (paired) contig 35 mapping	Mate-pair trimmed (paired) contig 35	1499	2764	1362	1402	946	246

Figure 24.37: There are mismatches towards the end of the reads.

24.4 Mapping SOLiD reads in color space

The SOLiD sequencing technology from Applied Biosystems is different from other sequencing technologies since it does not sequence one base at a time. Instead, two bases are sequenced at a time in an overlapping pattern. There are 16 different dinucleotides, but in the SOLiD technology, the dinucleotides are grouped in four carefully chosen sets, each containing four dinucleotides. The colors are as follows:

Base 1	Base 2			
	A	C	G	T
A	●	●	●	●
C	●	●	●	●
G	●	●	●	●
T	●	●	●	●

Notice how a base and a color uniquely defines the following base. This approach can be used to deduce a whole sequence from the initial nucleotide and a series of colors. Here is a sequence and the corresponding colors.

Sequence T A C T C C A T G C A
Colors ● ● ● ● ● ● ● ● ● ● ●

The colors do not uniquely define the sequence. Here is another sequence with the same list of colors:

Sequence A T G A G G T A C G T
Colors ● ● ● ● ● ● ● ● ● ● ●

But if the first nucleotide is known, the colors do uniquely define the remaining sequence. This is exactly the strategy used in SOLiD sequencing: The first nucleotide is known from the primer used, and the remaining nucleotides are deduced from the colors.

As with other sequencing technologies, errors do occur with the SOLiD technology. If a single nucleotide is changed, two colors are affected since a single nucleotide is contained in two overlapping dinucleotides:

```

Sequence  T A C T C C A T G C A
Colors    . . . . .

```

```

Sequence  T A C T C C A A G C A
Colors    . . . . .

```

Sometimes, a wrong color is determined at a given position. Due to the dependence between dinucleotides and colors, this affects the remaining sequence from the point of the error:

```

Sequence  T A C T C C A T G C A
Colors    . . . . .

```

```

Sequence  T A C T C C A A C G T
Colors    . . . . .

```

Thus, when the instrument makes an error while determining a color, the error mode is very different from when a single nucleotide is changed. This ability to differentiate different types of errors and differences is a very powerful aspect of SOLiD sequencing. With other technologies sequencing errors always appear as nucleotide differences.

24.4.1 Viewing color space information

Importing data from SOLiD systems (see section 6.3.4) will from *CLC Genomics Workbench* be imported as color space. This means that if you open the imported data, it will look like figure 24.38

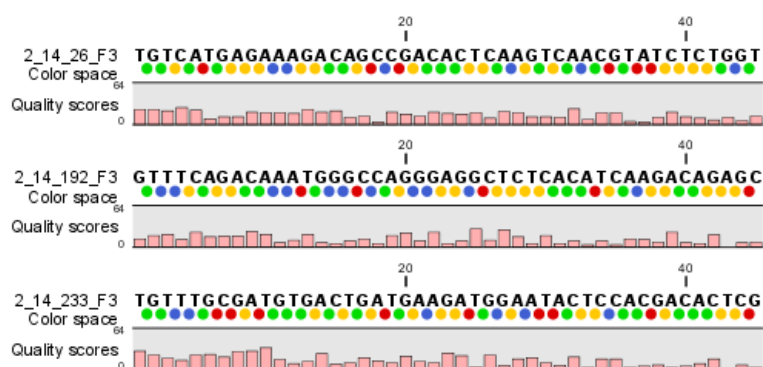

Figure 24.38: Color space sequence list.

In the **Side Panel** under **Nucleotide info**, you find the **Color space encoding** group which lets you define a few settings for how the colors should appear. These settings are also found in the side panel of mapping results and single sequences.

Infer encoding This is used if you want to display the colors for non-color space sequence (e.g. a reference sequence). The colors are then simply inferred from the sequence.

Show corrections This is only relevant for mapping results - it will show where the mapping process has detected color errors. An example of a color error is shown in figure 24.39.

Hide unaligned ends This option determines whether color for the unaligned ends of reads should be displayed. It also controls whether colors should be shown for gaps. The idea behind this is that these color dots will interfere with the color alignment, so it is possible to turn them off.

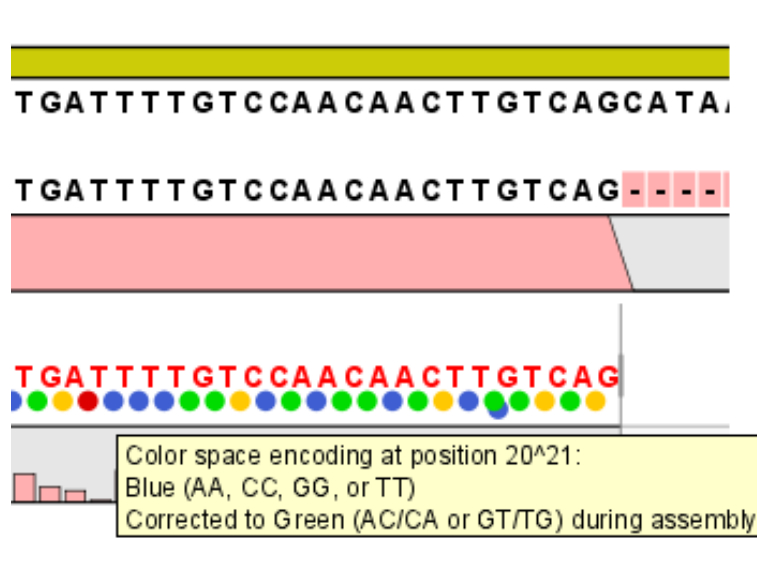

Figure 24.39: One of the dots have both a blue and a green color. This is because this color has been corrected during mapping. Putting the mouse on the dot displays the small explanatory message.

24.4.2 Mapping in color space

Reads from a SOLiD sequencing run may exhibit all the same differences to a reference sequence as reads from other technologies: mismatches, insertions and deletions. On top of this, SOLiD reads may exhibit color errors, where a color is read wrongly and the rest of the read is affected. If such an error is detected, it can be corrected and the rest of the read can be converted to what it would have been without the error.

Consider this SOLiD read:

Read	T A C T C C A A C G T
Colors	• • • • • • • • • •

The first nucleotide (T) is from the primer, so this is ignored in the following analysis. Now, assume that a reference sequence is this:

Reference	G C A C T G C A T G C A C
Colors	• • • • • • • • • •

Here, the colors are just inferred since they are not the result of a sequencing experiment.

Looking at the colors, a possible alignment presents itself:

```

Reference  G C A C T G C A T G C A C
Colors      . . | . | . | . : . | . | . : . : . : . : .
              | | | : | | : : : :
Read       A C T C C A A C G T
Colors      . . . . . . . . .
  
```

In the beginning of the read, the nucleotides match (ACT), then there is a mismatch (G in reference and C in read), then two more matches (CA), and finally the rest of the read does not match. But, the colors match at the end of the read. So a possible interpretation of the alignment is that there is a nucleotide change in position four of the read and a color space error between positions six and seven in the read. Such an interpretation can be represented as:

```

Reference  G C A C T G C A T G C A C
              | | | : | | | | |
Read       A C T C C A*T G C A
  
```

Here, the * represents a color error. The remaining part of the displayed read sequence has been adjusted according to the inferred error. So this alignment scores nine times the match score minus the mismatch cost and a color error cost. This color error cost is a new parameter that is introduced when performing read mapping in color space.

Note that a color error may be inferred before the first nucleotide of a read. This is the very first color after the known primer nucleotide that is wrong, changing the whole read.

Here is an example from a set of real SOLiD data that was reference assembled by taking color space into account using ungapped global alignments.

444_1840_767_F3 has 1 match with a score of 35:

```

1046535 GATACTCAATGCCGCCAAAGATGGAAGCCGGGCCA 1046569 reference
      |||
      GATACTCAATGCCGCCAAAGATGGAAGCCGGGCCA reverse read
  
```

444_1840_803_F3 has 0 matches

444_1840_980_F3 has 1 match with a score of 29:

```

2620828 GCACGAAAACGCCCGTGGCTGGATGGT*CAAC*GTC 2620862 reference
      |||
      GCACGAAAACGCCCGTGGCTGGATGGT*CAAC*GTC read
  
```

444_1840_1046_F3 has 1 match with a score of 32:

```

3673206 TT*GGTCAGGGTCTGGGCTTAGGCGGTGAATGGGGC 3673240 reference
      ||*
      TT*GGTCAGGGTCTGGGCTTAGGCGGTGAATGGGGC reverse read
  
```

444_1841_22_F3 has 0 matches

444_1841_213_F3 has 1 match with a score of 29:

```

1593797 CTTTG*AGCGCATTGGTTCAGCGTGTAATCTCCTGCA 1593831   reference
      |||||*||||||| |||||
      CTTTG*AGCGCATTAGTTCAGCGTGTAATCTCCTGCA           reverse read

```

The first alignment is a perfect match and scores 35 since the reads are all of length 35. The next alignment has two inferred color errors that each count is -3 (marked by * between residues), so the score is $35 - 2 \times 3 = 29$. Notice that the read is reported as the inferred sequence taking the color errors into account. The last alignment has one color error and one mismatch giving a score of $34 - 3 - 2 = 29$, since the mismatch cost is 2.

Running the same reference assembly without allowing for color errors, the result is:

444_1840_767_F3 has 1 match with a score of 35:

```

1046535 GATACTCAATGCCGCCAAAGATGGAAGCCGGGCCA 1046569   reference
      |||||
      GATACTCAATGCCGCCAAAGATGGAAGCCGGGCCA           reverse read

```

444_1840_803_F3 has 0 matches

444_1840_980_F3 has 0 matches

444_1840_1046_F3 has 1 match with a score of 29:

```

3673206 TTGGTCAGGGTCTGGGCTTAGGCGGTGAATGGGGC 3673240   reference
      |||||
      AAGGTCAGGGTCTGGGCTTAGGCGGTGAATGGGGC           reverse read

```

444_1841_22_F3 has 0 matches

444_1841_213_F3 has 0 matches

The first alignment is still a perfect match, whereas two of the other alignment now do not match since they have more than two errors. The last alignment now only scores 29 instead of 32, because two mismatches replaced the one color error above. This shows the power of including the possibility of color errors when aligning: many more matches are found.

The reference assembly program in *CLC Genomics Workbench* does not directly support alignment in color space only, but if such an alignment was carried out, sequence 444_1841_213_F3 would have three errors, since a nucleotide mismatch leads to two color space differences. The alignment would look like this:

444_1841_213_F3 has 1 match with a score of 26:

```

1593797 CTTTG*AGCGCATT*G*GTCAGCGTGTAATCTCCTGCA 1593831   reference
      |||||*|||||||*|*|||||||
      CTTTG*AGCGCATT*G*GTCAGCGTGTAATCTCCTGCA           reverse read

```

So, the optimal solution is to both allow nucleotide mismatches and color errors in the same program when dealing with color space data. This is the approach taken by the assembly program in *CLC Genomics Workbench*.

Note! If you set the color error cost as low as 1 while keeping the mismatch cost at 2 or above, a mismatch will instead be represented as two adjacent color errors.

24.5 Local realignment

The goal of the local realignment tool is to improve on the alignments of the reads in an existing read mapping. The local realignment algorithm works by exploiting the information available in the alignments of *other* reads when it is attempting to re-align any given read. Most mappers do not use cross-read information as it would be computationally prohibitive to do within the mapping algorithm. However, once the reads have been mapped, local realignment procedures can exploit this information.

Realignment will typically occur in areas around insertions and deletions in the sample reads relative to the reference. In such regions we wish to see our reads mapped with one end of the read on one side of the indel and the rest mapped on the other side. However, the mapper that originally mapped the reads to the reference does not have information about the existence of an indel to use when mapping a given read. Thus, reads that are mapped to such regions, but that only have a short part of the read representing the region on one side of the indel, will typically not be mapped properly across the indel, but instead be mapped with this end unaligned, or into the indel region with many mismatches. The Local Realignment tool can use information from the other reads mapping to a region containing an indel, including reads that are located more centered across the indel and thus have been mapped with ends on either side of the indel. As a result an alternative mapping, as good as or better than the original, can be generated.

Local realignment will typically have an effect on any read mapping, whether the reads were mapped using a local or global alignment algorithm (i.e. with the Global alignment option of the mapping tool unchecked (the default) or checked, respectively). An example of the effect of using the Local Realignment tool on a read mapping made using the local alignment algorithm is shown in figure 24.40. An example in the case of a mapping made using the global alignment algorithm is shown in figure 24.41.

24.5.1 Method

The local realignment algorithm uses a variant of the approach described by Homer et al. [Homer N, 2010]. In the first step, alignment information of all input reads are collected in an efficient graph-based data structure, which is essentially similar to a de-Brujn graph. This realignment graph represents how reads are aligned to the reference sequence and how reads overlap each other. In the second step, metadata are derived from the graph structure that indicate at which alignment positions realignment could potentially improve the read mapping, and also provides hypotheses as to how reads should be realigned to yield the most concise multiple alignment. In the third step the realignment graph and its metadata are used to actually perform the local realignment of each individual read. Figure 24.42 depicts a partial realignment graph for the read mapping shown in figure 24.40.

24.5.2 Realignment of unaligned ends

A typical error in read alignments is the occurrence of unaligned ends (also known as soft-clipped read ends). These unaligned ends are introduced by the read mapper as a consequence of an unresolved indel towards the end of a read. Those unaligned ends can be realigned in many

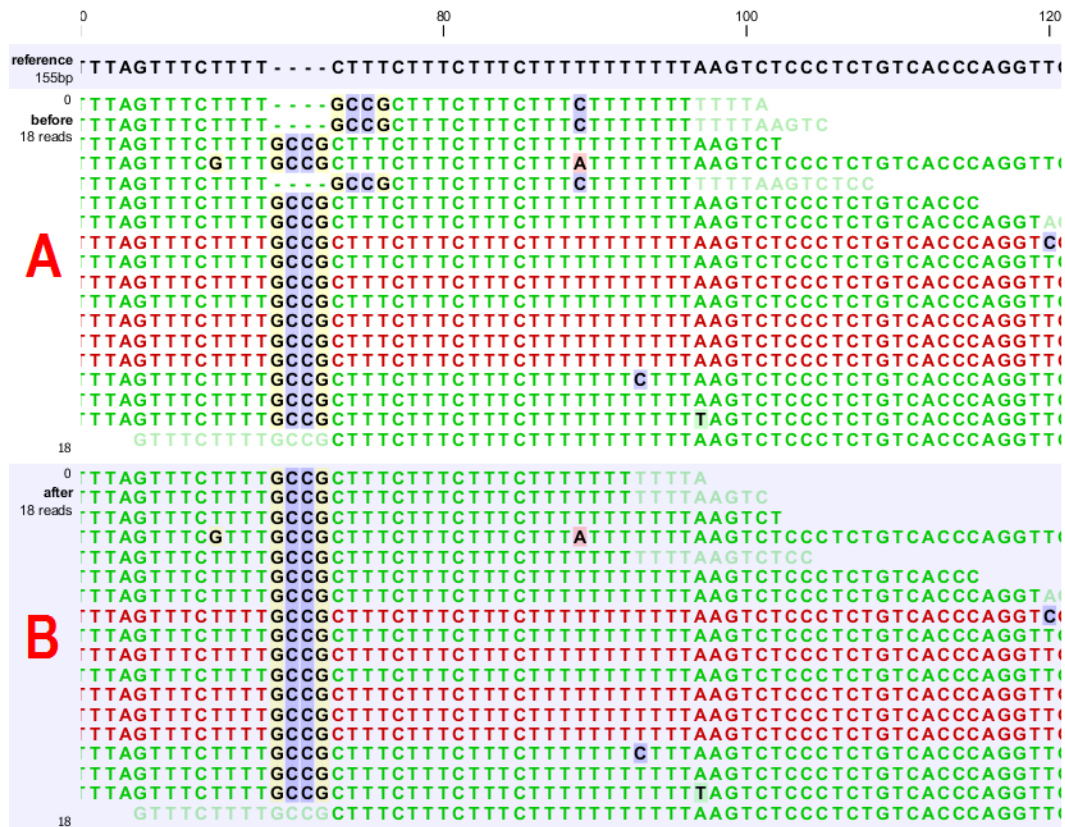

Figure 24.40: Local realignment of a read mapping produced with the 'local' option. [A] The alignments of the first, second, and fifth read in this read mapping do not support the four-nucleotide insertion supported by the remaining reads. A variant caller might be tempted to call a heterozygous insertion of four nucleotides in one allele and heterozygous replacement of four nucleotides in a second allele. [B] After applying local realignment, the first, second, and fifth read consistently support the four-nucleotide insertion.

cases, after the read itself has been locally realigned according to the indel that prevented the read mapper from aligning the read ends correctly. Figure 24.43 depicts such an example.

24.5.3 Guided Realignment

One limitation of the local realignment algorithm employed is that at least one read must be aligned correctly according to the true indel present in the data. If none of the reads is aligned correctly, local realignment cannot improve the alignment, since it lacks information about how to do so. To overcome this limitation, local realignment can be guided in two ways:

1. **Guidance variants:** By supplying the Local realignment tool with a track of guidance variants. There are two modes for using the guidance variant track: either the 'un-forced' guidance mode (if the 'Force realignment to guidance-variants' is left un-ticked) or the 'forced' guidance mode (if the 'Force realignment to guidance-variants' is ticked). In the 'unforced' mode, 'pseudo-reads' are given to the local realignment algorithm representing the guidance variants, allowing the local realignment algorithm to explore the paths in the graph corresponding to these alignments. In the 'forced' mode, 'pseudo-references' are given to the local realignment algorithm representing the guidance variants, allowing



Figure 24.41: Local realignment of a read mapping produced with the 'global' option. Before realignment the green read was mapped with two mismatches. After realignment it is mapped with the inserted 'CCC' sequence (seen in the alignment of the red read) and no mismatches.

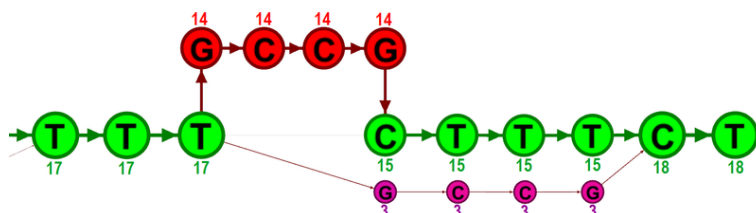

Figure 24.42: The green nodes represent nucleotides of the reference sequence. The four red nodes represent the four-nucleotide insertion observed in fourteen mapped reads. The four violet nodes represent the four mismatches to the reference sequence observed in three mapped reads. During realignment of the original reads, two possible paths through the graph are discovered. One path leads through the four red nodes, the other through the four violet nodes. Since red nodes have been observed in fourteen of the original reads, whereas the violet nodes have only been seen in three original reads, the path through the four red nodes is preferred over the path through the violet nodes.

the reads to be aligned to allele sequences of these in addition to the original reference sequence - with matches being awarded and encouraged equally much. The 'unforced' mode can be used with any guidance variant track as input. The 'force' mode should *only* be used with guidance variants for which there is strong prior evidence that they exist in the data (e.g., the 'InDel' track from the Structural Variants' tool (see Section 25.2) produced on the read mapping that is being aligned). Unless you do have strong evidence for the presence of these guidance variants, we do not recommend using the 'forced' mode as it can lead to the introduction of false positives in your alignment and all subsequent analyses.

2. **Concurrent local realignment of multiple samples:** Multiple input read mappings increase the chance to encounter at least one read mapped correctly. This guiding mechanism has been particularly designed for scenarios, where samples are known to be related, such as in family trials.

Figure 24.44 and figure 24.45 show examples that can be improved by guiding the local realignment algorithm.

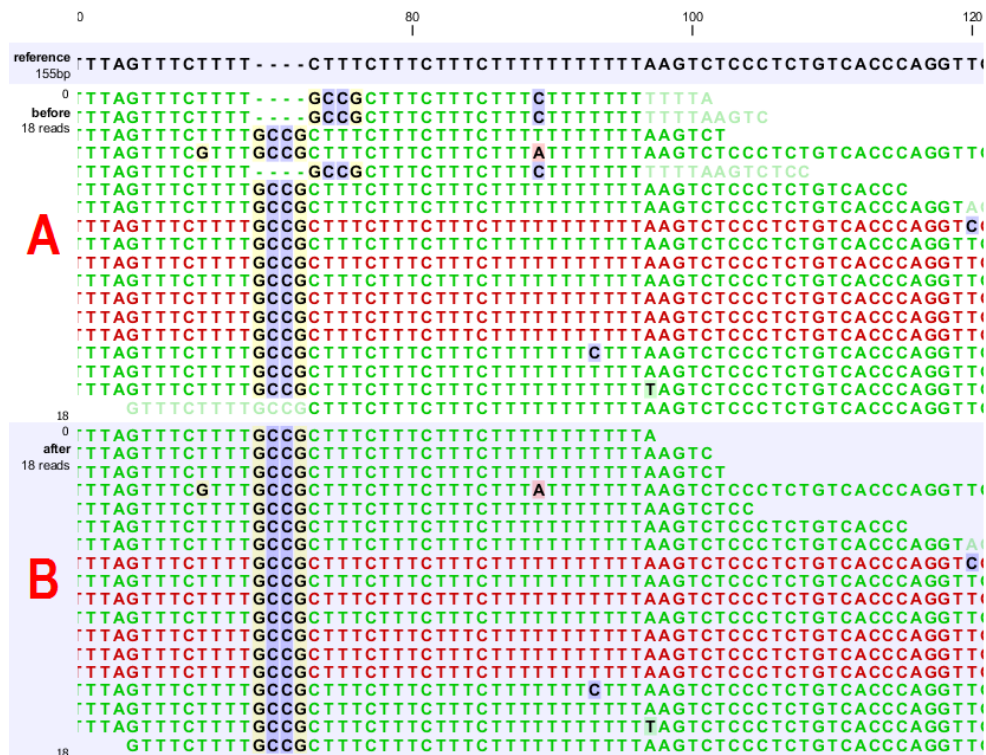

Figure 24.43: [A] The alignments of the first, second, and fifth read in this read mapping do not support the four-nucleotide insertion supported by the remaining reads. Additionally, the first, second, fifth and the last reads have unaligned ends. [B] After applying local realignment the first, second and fifth read consistently support the four-nucleotide insertion. Additionally, all previously unaligned ends have been realigned, because they perfectly match the reference sequence now (see also figure 24.40).

24.5.4 Multi-pass local realignment

As described in section 24.5.1 the algorithm initially builds the realignment graph using the input read mapping. After the graph has been built the algorithm realigns individual reads based on information inferred from the realignment graph structure and its associated metadata. In some cases repetitive realignment iterations yield even more improvements, because with each realignment iteration the structure of the realignment graph changes slightly, potentially permitting further improvements. Local realignment therefore supports to perform multiple iterations implicitly. This is not only considered a convenience feature, but also saves a great deal of runtime by avoiding repeated transfers of large input data sets. For most samples local realignment will quickly saturate in the number of improvements. Generally, two realignment passes are strongly recommended. More than three passes rarely yield further improvements.

24.5.5 Known Limitations

The major limitation of the local realignment algorithm is the necessity of at least one read being mapped correctly according to an indel present in the data. Insufficient alignment data results in suboptimal realignments or no realignments at all. As a work-around, local realignment can be guided by supplying a track of variants that enable the algorithm to determine improvements. Further guidance can be achieved by increasing the amount of alignment information and thereby



Figure 24.44: [A] Three reads are misaligned in the presence of a four nucleotide insertion relative to the reference. [B] When applying local realignment without guidance the alignment is not improved. [C] Here local realignment is performed in the presence of the guiding variant track seen in (E). This enables the algorithm to consider alternative alignments, which are accepted whenever they have significant improvements over the original (as in read three that has a comparatively long unaligned-end). [D] If the alignment is performed with the option "Force realignment to guidance-variants" enabled, the realignment will be forced to realign according to the guiding variants track shown in (E), and this will result in realignment of all three reads. [E] The guiding variants track contains, amongst others, the four nucleotide insertion.

increasing the chance to observe at least one read mapped correctly.

Reads are ignored, but retained in outputs, if:

- Lengths are longer than 50,000 base pairs.
- The alignment is longer than 50,000 base pairs.
- Crossing the boundaries of circular chromosomes.

Guiding variants are ignored, if:

- They are of type "Replacement".
- They are longer than 200 bp (set as default value, but can be changed using the Maximum Guidance Variant Length parameter).
- If they are inter-chromosomal structural variations.
- If they contain ambiguous nucleotides.

24.5.6 Computational Requirements

The realignment graph is produced using a sliding-window approach with a window size of 250,000 bp. If local realignment is run with multiple passes, then each pass has its own realignment



Figure 24.45: [B] Three reads are misaligned in the presence of a four nucleotide insertion into the reference. Applying local realignment without guiding information would not yield any improvements (not shown). [C] Performing local realignment on both samples (A) and (B) enables the algorithm to improve the alignments of sample (B).

graph. While memory consumption is typically below two gigabytes for single-pass, processor loads are substantial. Realigning a human sample of approximately 50x coverage will take around 24 hours on a typical desktop machine with four physical cores. Building the realignment graph and realignment of reads are parallelized actions, such that the algorithm scales very well with the number of physical cores. Server machines exploiting 12 or more physical cores typically run three times faster than the desktop with only four cores.

24.5.7 How to run the Local Realignment tool

The tool is found in the Toolbox:

Toolbox | NGS Core Tools (🗄️) | Local Realignment (🔍)

Select one or multiple read mappings as input. If one read mapping is selected, local realignment will attempt to realign all contained reads, if appropriate. If multiple read mappings are selected, their reference genome must exactly match. Local realignment will realign all reads from all input read mappings as if they came from the same input. However, local realignment will create one output read mapping for each input read mapping, thereby preserving the affiliation of each read to its sample. Clicking Next allows you to set parameters as displayed in figure 24.46.

Alignment settings

- Realign unaligned ends** This option, if enabled, will trigger the realignment algorithm to attempt to realign unaligned ends as described in section "Realignment of unaligned ends (soft clipped reads)". This option should be enabled by default unless unaligned ends arise from known artifacts (such as adapter remainders in amplicon sequencing setups) and are thus not expected to be realignable anyway. Ignoring unaligned ends will yield a significant run time improvement in those cases. Realigning unaligned ends under normal conditions (where unaligned ends are expected to be realignable), however, does not contribute a lot

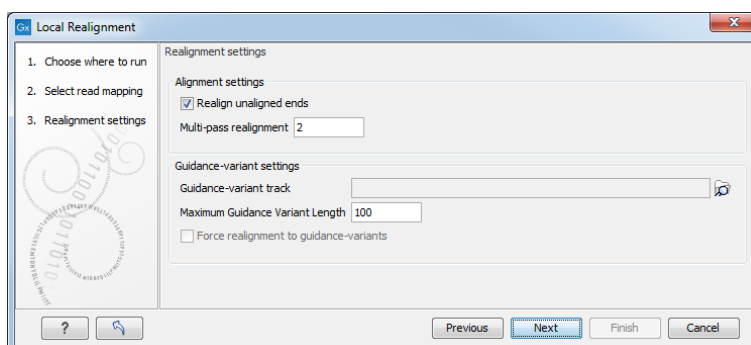

Figure 24.46: Set the realignment options.

of processing time.

- **Multi-pass realignment** This option is used to specify, how many realignment passes shall be performed by the algorithm. More passes improve accuracy at the cost of longer run time (approx. 25% per pass). Two passes are recommended; more than three passes barely yield further improvements.

Guidance-variant settings

- **Guidance-variant track** A track of variants to guide realignment of reads. Guiding can be used in at least two scenarios: (1) if reads are short or expected variants are long and (2) if cross sample comparisons are performed and some samples are already well genotyped. A track of variants can be produced by either of the variant callers, The Structural Variant tool or by importing variants from external data sources, such as dbSNP, etc.
- **Maximum Guidance Variant Length** set at 200 by default but can be increased to include guidance variants longer than 200 bp.

There are two modes for using the guidance track:

- **Un-forced** If the 'Force realignment to guidance-variants' is un-ticked the guidance variants are used as 'weak' prior evidence: each guidance variant will be represented by a pseudo-read, allowing the local realignment to explore the alignments that the guidance variants suggest. Any variant track may be used to guide the realignment when the un-forced mode is chosen.
- **Force realignment to guidance-variants** If the 'Force realignment to guidance-variants' is ticked the guidance variants are used as 'strong' prior evidence: a 'pseudo' reference will be generated for each guidance variant, and the alignment of nucleotides to their sequences will be awarded and encouraged as *much* as the alignment to the original reference sequence. Thus, the 'Force realignment to guidance-variants' options should *only* be used when there is prior information that the variants in the guidance variant track are infact present in the sample. This would e.g. be the case for an 'InDel' track produced by the Structural Variant tool (see Section 25.2), in an analysis of the same sample as the realignment is carried out on. Using 'forced' realignment to a general variant data base track is generally *strongly* discouraged.

The next dialog allows specification of the result handling. Under "Output options" it is possible to specify whether the results should be presented as a reads track or a stand-alone read mapping (figure 24.47).

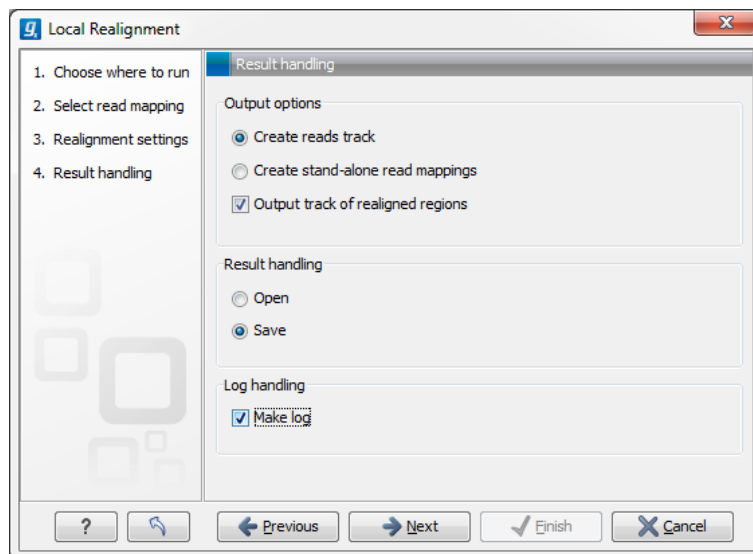

Figure 24.47: An output track of realigned regions can be created.

If enabled, the option **Output track of realigned regions** will cause the algorithm to output a track of regions that help pinpoint regions that have been improved by local realignment. This track has purely informative intention and cannot be used for anything else.

24.6 Merge mapping results

If you have performed two mappings with the same reference sequences, you can merge the results using the **Merge Read Mappings** (≡). This can be useful in situations where you have already performed a mapping with one data set, and you receive a second data set that you want to have mapped together with the first one. In this case, you can run a new mapping of the second data set and merge the results:

Toolbox | NGS Core Tools (≡) | Merge Read Mappings (≡)

This opens a dialog where you can select two or more mapping results, either in the form of tracks or read mappings. If the mappings are based on the same reference sequences (based on the name and length of the reference sequence), the reads will be merged into one mapping. If different reference sequences are used, they will simply be incorporated into the same result file (either a track or a mapping table).

The output from the merge can either be a track or standard mappings (equivalent to the read mapper's output, see section 24.1).

Click **Next** if you wish to adjust how to handle the results (see section 8.2). If not, click **Finish**. For all the mappings that could be merged, a new mapping will be created. If you have used a mapping table as input, the result will be a mapping table. Note that the consensus sequence is updated to reflect the merge. The consensus voting scheme for the first mapping is used to determine the consensus sequence. This also means that for large mappings, the data processing can be quite demanding for your computer.

24.7 Remove duplicate mapped reads

The purpose of this tool is to efficiently remove duplicate reads from a mapping, when duplicate reads have arisen due to the use of PCR amplification (or other enrichment) during sample preparation. This does not mean, however, that this tool should be used on all data that had an amplification step. In fact, use of this tool in the case of RNA-Seq data, amplicon data, or any sample where the start of a large number of reads are purposely at the same reference location, it is not recommended to make use of this tool. The tool may be used on mappings of single end reads, paired end reads or both.

A read duplication can be easily distinguished when mapping reads to a reference sequence as shown in the example in figure 24.48.

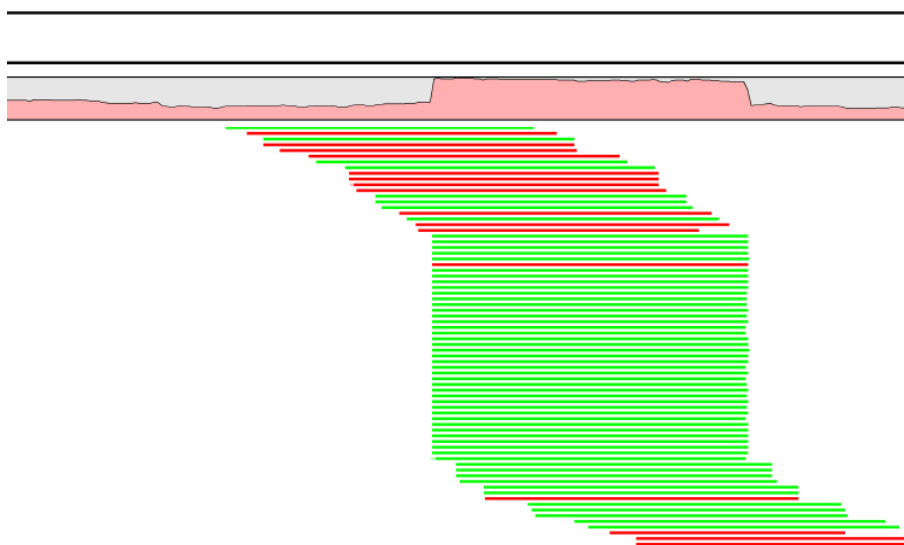

Figure 24.48: *Mapped reads with a set of duplicate reads, the colors denote the strand (green is forward and red is reverse).*

When sequencing library preparation involves a PCR amplification step, it is common to observe multiple reads where identical nucleotide sequences are disproportionately represented in the final results. Thus, to facilitate processing of mappings based on this kind of data, it may be necessary to perform a duplicate read removal step, which flags identical reads and subsequently removes them from the data set. However, this step is complicated by the low, but consistent, presence of sequencing errors that may cause otherwise identical sequences to differ slightly. Thus, it is important that the duplicate read removal includes some tolerance for nearly identical sequences, which could still be reads from the same PCR artifact.

In samples that have been mapped to a reference genome, duplicate reads from PCR amplification typically result in areas of disproportionately high coverage and are often the cause of significant skew in allelic ratios, particularly when replication errors are made by the enzymes (e.g. polymerases) used during amplification. Sequencing errors incorporated post-amplification can affect both sequence- and coverage-based analysis methods, such as variant calling, where introduced errors can create false positive SNPs, and ChIP-Seq, where artificially inflated coverage can skew the significance of certain locations. By utilizing the mapping information, it is possible to perform the duplicate removal process rapidly and efficiently.

Note! We only recommend using the duplicate read removal if there are amplification steps involved in the library preparation. It is not recommended for RNA-Seq data, amplicon data, or any sample where the start of a large number of reads are purposely at the same reference location.

The method used by the duplicate read removal is to identify reads that share common coordinates (e.g. the same start and end coordinate), sequencing direction (or mapped strand) and the same sequence, these being the unifying characteristics behind sequencing reads that originate from the same amplified fragments of nuclear material. However, due to the frequent occurrence of sequencing errors, the tool utilizes simple heuristics to prune sequences with small variations from the consensus, as would be expected from errors observed in data from next-generation sequencing platforms. Base mismatch errors that were incorporated during amplification or prior to amplification will be indistinguishable from SNPs and may not be filtered out by this tool.

24.7.1 Algorithm details and parameters

The algorithm operates with the following assumption: Mapped reads from duplicated DNA fragments will share a mapping orientation (e.g. will map to the same strand), and depending on their orientation, will share either a start coordinate (forward reads), an end coordinate (reverse reads) or both (paired end reads).

Based on this assumption, a group of reads that share identical start and end coordinates (or start coordinate and length for single end reads) and also share identical sequences can be considered as potential duplications of the same DNA fragment. These reads are then investigated to find reads to be removed and reads to be kept. In order to explain how this works, we will use a small example shown in figure 24.49.

AC <u>G</u> GACTG <u>C</u> TT	60
ACTGACTG <u>C</u> TT	5
ACTGACTG <u>A</u> TT	100

Figure 24.49: An alignment of three different sequence. The numbers are read counts, e.g. the read at the top occurs 60 times.

The example shows 165 reads that share the same start position and orientation and are considered for duplicate read removal. 60 reads share the sequence shown at the top, 5 reads share the middle sequence, and 100 reads share the sequence at the bottom. The differences are at position 3 and 9 (underlined).

The tool will now create a tree structure out of these reads as illustrated in figure 24.50.

The first branch point in the tree is at the third position, where sequence number one has a G and the other sequences have a T. The other two sequence disagree at position nine, where one has a C and another has an A.

The next step is to iteratively merge the branches, starting from the end of the tree. The first branch point to consider is at position nine. Since only 5 reads have a C and 100 reads have an A, the C branch is collapsed. This is shown in figure 24.51.

As a user, you can specify the **threshold** for when the reads should be merged. The default is 20 %: when the minority branch has less than 20 % of the read count of the both branches, it is

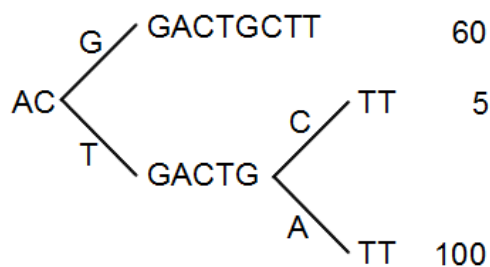

Figure 24.50: The reads from figure 24.49 represented as a Patricia tree [Morrison, 1968].

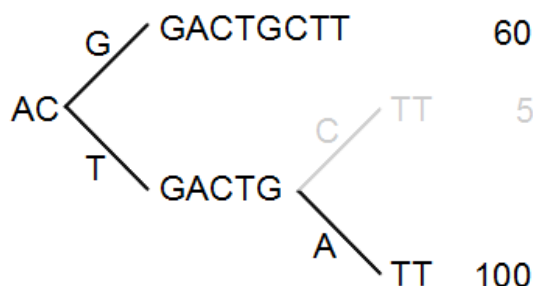

Figure 24.51: Merging the sequences.

collapsed.

The next branch to consider is at the third position, where there are now 105 reads that have a T and 60 reads that have a G (see figure 24.52).

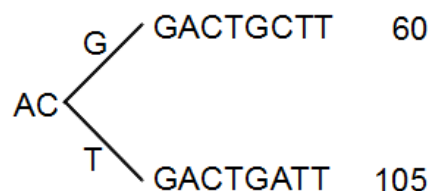

Figure 24.52: Merging the sequences.

With the default setting at 20%, these two branches will not be collapsed, because there are too many reads on the minority branch (60 reads versus 105 reads). Since this process is aimed at collapsing reads that are only distinguished apart by sequencing errors, you would not expect this situation to be caused by sequencing errors, but rather true biological variation (or PCR errors in the early cycles that are indistinguishable from true variation).

If we raised the threshold to 60%, the two branches above would be merged into one if it was not for the second rule governing the merging of branches: The sequences have to be identical except for the difference at the branch point. Looking at the sequences in figure 24.52, there is a difference at position 9 which means that these two branches would never be merged, regardless the threshold and the read counts.

The result of the duplicate reads removal in this example would be that the 165 reads are reduced to two in the result.

24.7.2 Running the duplicate reads removal

The tool is found in the Toolbox:

Toolbox | NGS Core Tools (📁) | Remove Duplicate Mapped Reads (📄)

This opens a dialog where you can select mapping results in read tracks (📄) format. Clicking **Next** allows you to set the threshold parameters as displayed in figure 24.53.

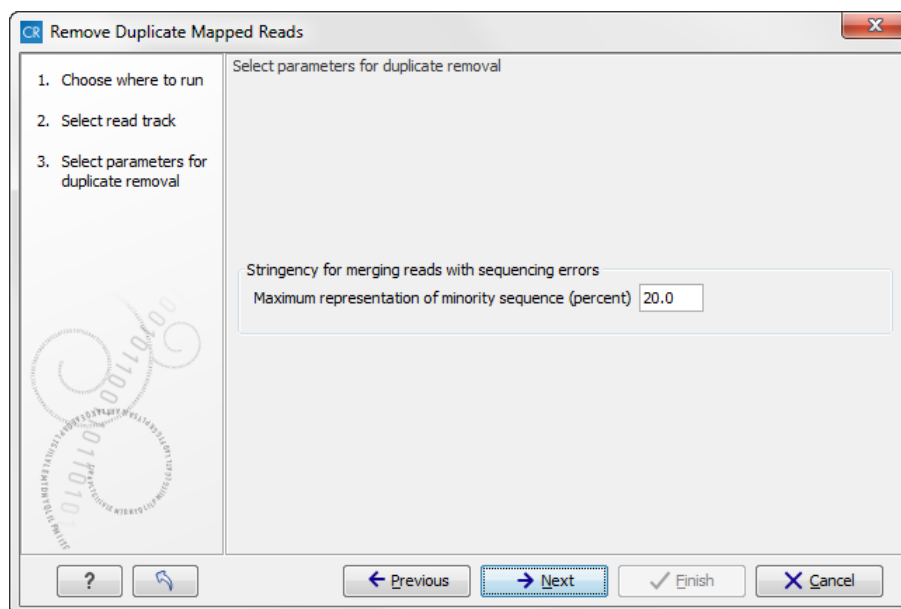

Figure 24.53: Setting the stringency for merging similar reads.

The parameter is explained in detail in section 24.7.1.

Clicking **Next** will reveal the output options. The main output is a list of the reads that remain after the duplicates have been removed. In addition, you can get the following output:

List of duplicate sequences These are the sequences that have been removed.

Report This is a brief summary report with the number of reads that have been removed (see an example in figure 24.54).

Note! The Remove Duplicate Mapped Reads tool may run this before or after local realignment. The order in which these two tools are run should make little if any difference.

24.8 Extract consensus sequence

For all kinds of read mappings, including those generated from *de novo* assembly or RNA-seq analyses, a consensus sequence can be extracted. In addition, you can extract a consensus sequence from a BLAST result as well. The consensus sequence extraction tool can be run in batch and as part of workflows.

To start the tool:

Toolbox | NGS Core Tools (📁) | Extract Consensus Sequence (📄)

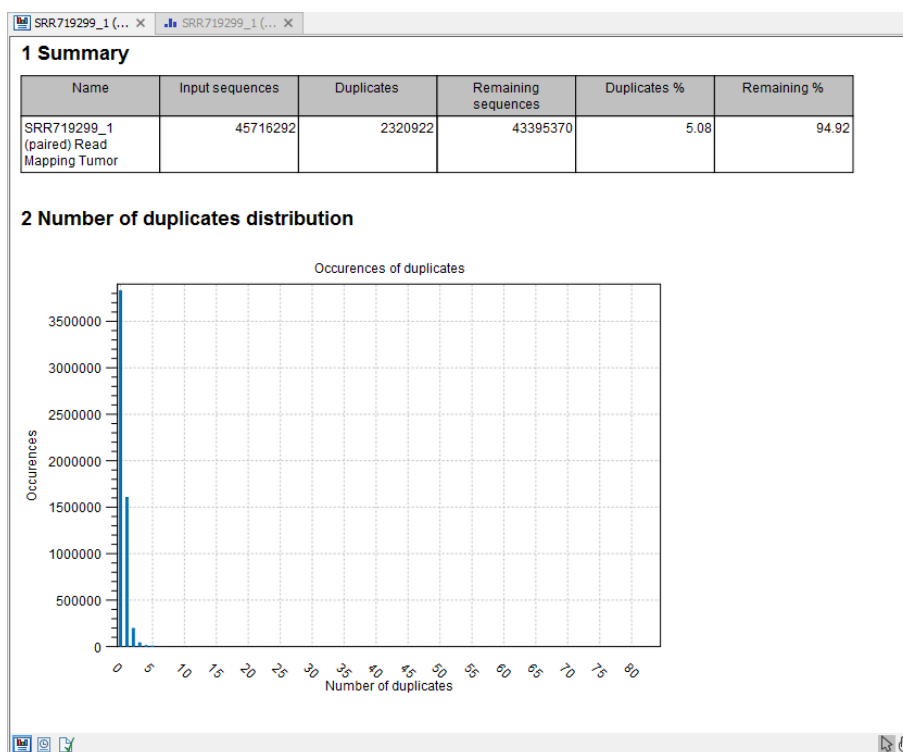

Figure 24.54: Summary statistics on the duplicate mapped reads.

This opens a dialog where you can select mappings, either in the form of tracks or read mappings, or BLAST results. Click **Next** to specify how the consensus sequence should be created (see figure 24.55).

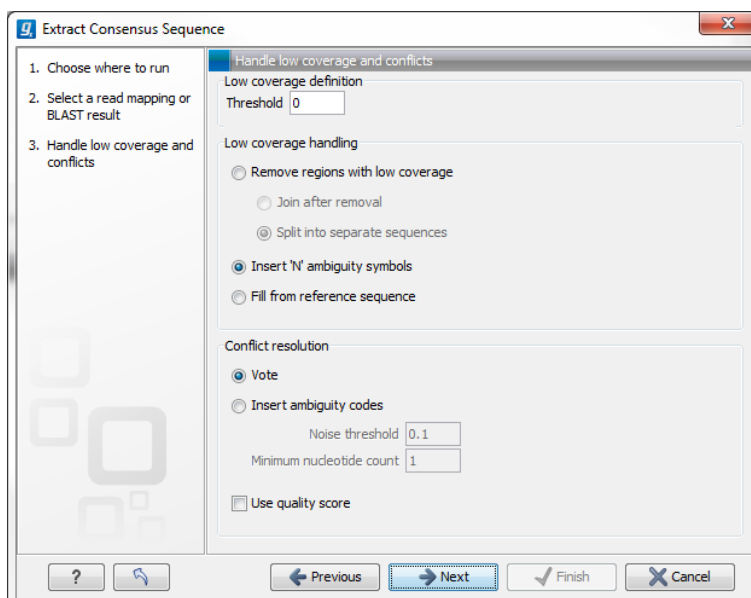

Figure 24.55: Specifying how the consensus sequence should be extracted.

It is also possible to extract a consensus sequence from a mapping view by right-clicking the name of the consensus or reference sequence or a selection on the reference sequence and select **Extract Consensus Sequence** (↕).

When extracting a consensus sequence, you can decide how to handle regions with low coverage (a definition of coverage can be found in section 24.2.8). The first step is to define a **threshold for when coverage is considered low**. The default value is 0, which means that low coverage is defined as no coverage (i.e. no reads align to the reference at this position). That means if you have one read covering a given position, it will only be that read that determines the consensus sequence. If you need more confidence that the consensus sequence is correct, we advise raising this value. Setting a higher low coverage threshold will require more mapped reads to construct the consensus sequence.

A consensus based on mapped reads cannot be generated in regions that meet or are below the value set for the low coverage threshold, there are several options for handling these low coverage regions:

- **Remove regions with low coverage.** When using this option, no consensus sequence is created for the low coverage regions. There are two ways of creating the consensus sequence from the remaining contiguous stretches of high coverage: either the consensus sequence is **split** into separate sequence when there is a low coverage region, or the low coverage region is simply ignored, and the high-coverage regions are directly **joined** (in this case, an annotation is added at the position where a low coverage region is removed in the consensus sequence produced, see below).
- **Insert 'N' ambiguity symbols.** This will simply add Ns for each base in the low coverage region. An annotation is added for the low coverage region in the consensus sequence produced (see below).
- **Fill from reference sequence.** This option will use the sequence from the reference to construct the consensus sequence for low coverage regions. An annotation is added for the low coverage region in the consensus sequence produced (see below).

In addition to deciding how to handle low coverage regions, you can also decide how to handle conflicts or disagreement between the reads when building a consensus sequence in regions above the low coverage threshold:

- **Vote.** Whenever the reads disagree on the base at a given position, the vote resolution will let the majority of the reads decide which base is correct.
 - If the most common symbol is a gap, then the consensus symbol is a gap.
 - If there are equal numbers of gaps and non-gaps, then it is one of the other symbols.
 - When choosing between symbols we choose in the order A - C - G - T.
 - Ambiguous symbols cannot be chosen.

In addition, you can specify to let the voting use the base calling **quality scores** from the reads. This is done by simply adding all quality scores for each base and let the sum determine which one is correct. The base with the highest total quality scores will be chosen. If there are two bases that end up summing to the same total quality score for all reads at that location, A is preferred before C, C before G, and G before T. An annotation with the complete information that was used to resolve the conflict will be added.

- **Insert ambiguity codes.** When this options is selected, read conflicts are addressed by using an ambiguity code representing all read bases represented at the reference location.

The problem with the voting option is that it will not be able to represent true biological heterozygous variation in the data. For a diploid genome, if two different alleles are present in an almost even number of reads, only one will be represented in the consensus sequence. With the option to insert ambiguity codes, this can be solved. (The IUPAC ambiguity codes used can be found in Appendix H and G.) However, if an ambiguity code would always be inserted if just one read had a different base, there would be an ambiguity code whenever there was a sequencing error. In high-coverage NGS data that would be a big problem, because sequencing errors would be abundant. To solve this problem, you can specify a **Noise threshold**. The default value for this is 0.1 which means that for a base to contribute to the ambiguity code, it must be in at least 10 % of the reads at a given position. The **Minimum nucleotide count** specifies the minimum number of reads that are required before a nucleotide is included. Nucleotides below this limit are considered noise. If no nucleotide passes the noise filters, the position is omitted from the consensus sequence.

- **Use quality score.** The "Use quality score" checkbox option is available for conflicts regardless of whether "Vote" or "Insert ambiguity codes" has been selected. The "Use quality score" checkbox option allows you to use the base calling **quality scores** from the reads. This is done by simply adding all the quality scores for each base and let the sum determine which bases to consider. In other words, if quality scores are used, we will sum the quality score (instead of amount of reads) for each base on each position before applying the noise filters and finally call the consensus symbol.

Click **Next** to set the output option as shown in figure 24.56).

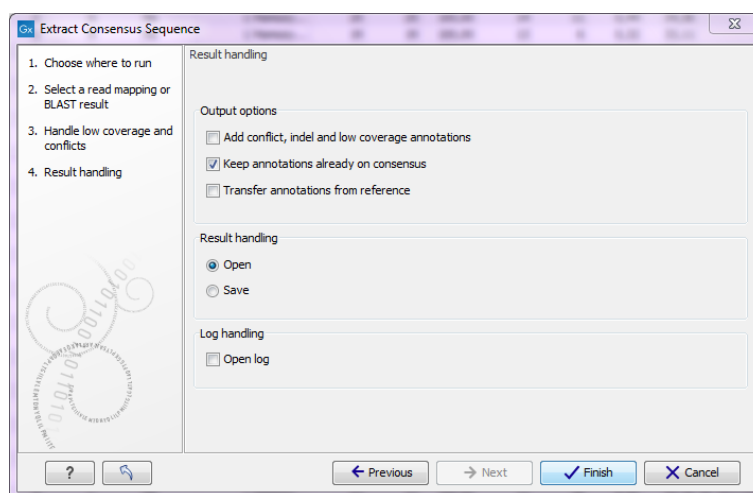

Figure 24.56: Choose to add annotations to the consensus sequence.

The annotations that can be added to the consensus sequence produced by this tool, show both conflicts that have been resolved and low coverage regions (unless you have chosen to split the consensus sequence). Please note that for large data sets, this can amount to a very high number of annotations, which will cause the tool to take longer to complete, and the result will take up much more disk space.

For stand-alone read mappings, it is possible to transfer existing annotations to the consensus sequence produced. Since the consensus sequence produced may be broken up, the annotations will also be broken up, and may not have the same length as before. In some cases, gaps and low-coverage regions will lead to differences in the sequence coordinates between the input data

and the new consensus sequence. The annotations copied will be placed in the region on the consensus that corresponds to the region on the input data, but the actual coordinates might have changed.

Track-based read mappings do not themselves contain annotations and thus the options related to transferring annotations, "Transfer annotations from the reference sequence" and "Keep annotations already on consensus", cannot be selected for this type of input.

Copied/transferred annotations will contain the same qualifier text as the original. That is, the text is not updated. As an example, if the annotation contains 'translation' as qualifier text this translation will be copied to the new sequence and will thus reflect the translation of the original sequence, not the new sequence, which may differ.

The resulting consensus sequence (or sequences) will have quality scores assigned if quality scores were found in the reads used to call the consensus. For a given consensus symbol X we compute its quality score from the "column" in the read mapping. Let Y be the sum of all quality scores corresponding to the "column" below X , and let Z be the sum of all quality scores from that column that supported X ¹. Let $Q = Z - (Y - Z)$, then we will assign X the quality score of q where

$$q = \begin{cases} 64 & \text{if } Q > 64 \\ 0 & \text{if } Q < 0 \\ Q & \text{otherwise} \end{cases}$$

24.9 Sample reads

The **Sample Reads** tool is very useful for reducing the size of data sets. It allows the user to reduce the number of reads in a sequence list to an absolute number of reads, or a pre-defined percentage of the original list.

A reduced sequence list can be relevant when editing contigs with a high coverage, as an excessive amount of reads can be overly resource-demanding and can hinder read mapping editor functions. Sampling reads, and subsequently mapping the sampled reads to contigs with the Map Reads to Contig tool can maintain the speed of many edit operations in the contig aligner without any loss of important information. Similarly, in the case of de novo assembly, very high coverage in a location will increase the probability this location is seen as a sequencing error. You can thus use the Sample Reads tool to reduce coverage to a maximum average coverage of 100x using the following calculation:

1. Multiply the estimated size of the genome you intend to assemble by 100. This value will be the total number of bases you should use as input for assembly.
2. Divide the total input bases the average length of your sequencing reads.
3. Use this number as input for the number of reads to obtain as output from the Sample Reads tool.

To learn more about the Map Reads to Contig tool and the De Novo Assembly tool, see chapter 28.

¹By supporting a consensus symbol, we understand the following: when conflicts are resolved using voting, then only the reads having the symbol that is eventually called are said to support the consensus. When ambiguity codes are used instead, all reads contribute to the called consensus and thus $Y = Z$.

To run the **Sample Reads** tool: **Toolbox** | **NGS Core Tools** () | **Sample reads** ()

This opens the dialog shown in figure 24.57. Select the relevant reads and click **Next**.

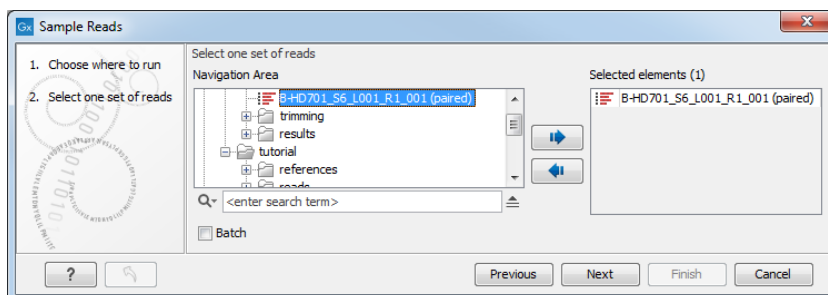

Figure 24.57: *Select the reads.*

This leads to the **Sample size parameters** step shown in figure 24.58.

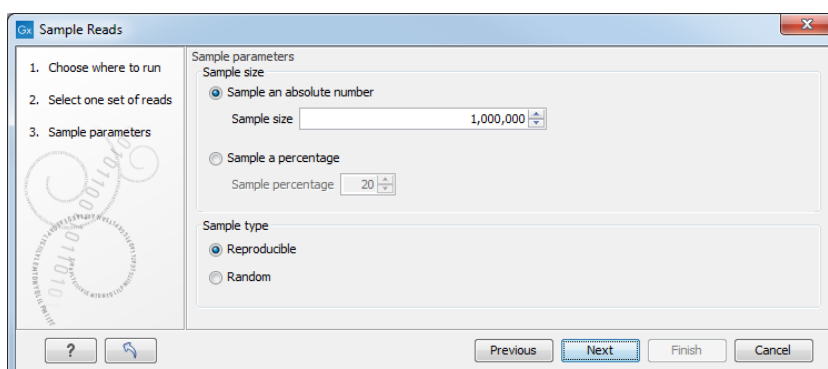

Figure 24.58: *Specify the sample size parameters.*

In the **Sample size parameters** it is possible to sample down to either an absolute number of reads, or a sample percentage of the original file, with sample percentage defining the percentage of the sub-sample paired reads (for single end reads) and pairs of reads (for paired reads).

It is also possible to choose between a **Reproducible** or **Random** output. The Reproducible option will always returns the same sample (i.e., containing the same reads) for a given sample size or percentage; the Random option returns a different sample each time the tool is run.

After the **Result handling** step, click **Finish**.

Chapter 25

Resequencing

Contents

25.1 Create Statistics for Target Regions	656
25.1.1 Running the Create Statistics for Target Regions	656
25.1.2 Coverage summary report	657
25.1.3 Per-region statistics	660
25.1.4 Coverage table	663
25.1.5 Coverage graph	663
25.2 InDels and Structural Variants	664
25.2.1 How to run the InDels and Structural Variants tool	664
25.2.2 The Structural Variants and InDels output	668
25.2.3 The InDels and Structural Variants detection algorithm	671
25.2.4 The InDels and Structural Variants detection algorithm - Step 1: Creating Left- and Right breakpoint signatures	672
25.2.5 The InDels and Structural Variants detection algorithm - Step 2: Creating Structural variant signatures	673
25.2.6 Theoretically expected structural variant signatures	674
25.2.7 How sequence complexity is calculated	679
25.3 Coverage analysis	680
25.3.1 Running the Coverage analysis tool	680
25.4 Variant Detectors - overview	683
25.4.1 Differences in the variants called by the different tools	684
25.4.2 How the variant detection tools work	687
25.5 Fixed Ploidy Variant Detection	688
25.5.1 Ploidy and sensitivity	689
25.6 Low Frequency Variant Detection	689
25.7 Basic Variant Detection	690
25.8 Variant Detectors - error model estimation	691
25.9 Variant Detectors - filters	691
25.9.1 General filters	691
25.9.2 Noise filters	693
25.10 Variant Detectors - the outputs	698

25.10.1 The variant track output	699
25.10.2 The annotated table output	702
25.10.3 The report	702
25.11 The Fixed Ploidy and Low Frequency variant callers: detailed descriptions . .	703
25.11.1 The Fixed Ploidy Variant Caller: Models and methods	703
25.11.2 The Low Frequency Variant caller: Models and methods	708
25.12 Variant data	711
25.12.1 Variant tracks	712
25.12.2 The annotated variant table	715
25.12.3 Variant types	716
25.13 Detailed information about overlapping paired reads	716
25.14 Annotate and filter variants	716
25.14.1 Filter against known variants	717
25.14.2 Annotating from known variants	718
25.14.3 Annotate with exon numbers	719
25.14.4 Annotate with flanking sequence	719
25.14.5 Identify candidate variants	720
25.14.6 Filter marginal variant calls	721
25.14.7 Filter reference variants	722
25.15 Comparing variants	722
25.15.1 Compare variants within group	722
25.15.2 Compare sample variants	723
25.15.3 Fisher exact test	723
25.15.4 Trio analysis	726
25.15.5 Filter Against Control Reads	728
25.16 Predicting functional consequences	729
25.16.1 Amino acid changes	729
25.16.2 Predict splice site effect	734
25.16.3 GO enrichment analysis	735
25.16.4 Conservation score annotation	737
25.16.5 Link Variants to 3D Protein Structure	737
25.16.6 Download 3D Protein Structure Database	750
25.17 Identify Known Mutations from Sample Mappings	750
25.17.1 How to run the Identify Known Mutations from Sample Mappings tool . .	751
25.17.2 Output from the Identify Known Mutations from Sample Mappings workflow	753

In the *CLC Genomics Workbench* resequencing is the overall category for applications comparing genetic variation of a sample to a reference sequence. This can be targeted resequencing of a single locus or whole genome sequencing. The overall workflow will typically involve read mapping, some sort of variant detection and interpretation of the variants.

This chapter describes the tools relevant for the resequencing workflows downstream from the actual read mapping which is described in chapter 24.

25.1 Create Statistics for Target Regions

This tool is designed to report the performance (enrichment and specificity) of a targeted re-sequencing experiment. Targeted re-sequencing is due to its low costs, very popular and several companies provide platforms and protocols (learn more at http://en.wikipedia.org/wiki/Exome_sequencing#Target-enrichment_strategies). Array-based approaches are offered by e.g. Agilent (SureSelect) and Roche Nimblegen. Furthermore, amplicon sequencing with PCR primers is offered by RainDance, Fluidigm and others.

Given an annotation track with the target regions (e.g. imported from a bed file), this tool will investigate a read mapping to determine whether the targeted regions have been appropriately covered by sequencing reads as well as information about how specific the reads map to the targeted regions. The results are provided both as a summary report and as track or table with detailed information about each targeted region.

Note! This tool is for re-sequencing data only; if you have RNA-seq data, please see section 26.1.

25.1.1 Running the Create Statistics for Target Regions

To create the target regions statistics:

Toolbox | Resequencing (🔍) | Create Statistics for Target Regions (📄)

This opens a wizard where you can select mapping results (📄) / (📄) / (📄). Clicking **Next** will take you to the wizard shown in figure 25.1.

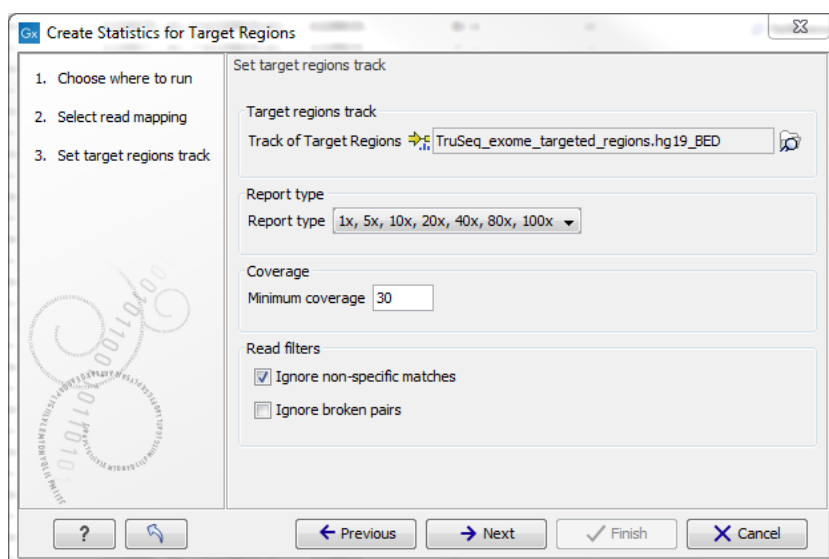

Figure 25.1: Specifying the track of target regions.

Click the **Browse** (🔍) icon to select an annotation track that defines the targeted regions of your reference genome. You can either import the target regions as an annotation file (see section 6.2) or convert (see section 23.4) from annotations on a reference genome that is already stored in the **Navigation Area**.

The **Report type** allows you to select different sets of predefined coverage thresholds to use for reporting (see below). Furthermore, you will be asked to provide a **Minimum coverage** threshold. This will be used to provide the length of each target region that has at least this coverage.

Finally, you are asked to specify whether you want to **Ignore non-specific matches** and **Ignore**

broken pairs. When these are applied reads that are non-specifically mapped or belong to broken pairs will be ignored.

Click **Next** to specify the type of output you want (see figure 25.2).

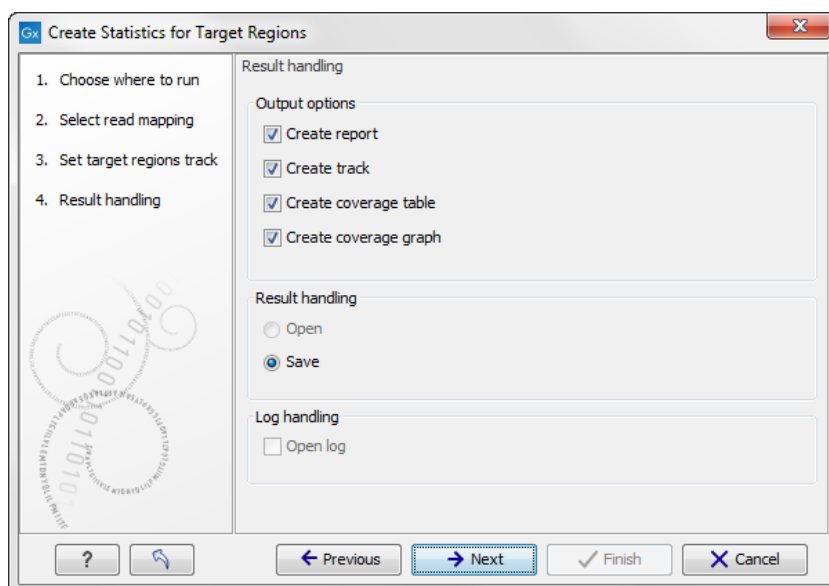

Figure 25.2: Specifying how the result should be reported.

There are three options:

- The report gives an overview of the whole data set as explained in section 25.1.2.
- The track gives information on coverage for each target region as described in section 25.1.3.
- The coverage table outputs coverage for each position in all the targets as described in section 25.1.4.
- The coverage graph outputs a graphical presentation of the coverage for each position in all the targets. Positions outside the targets will have the value 0. The values are calculated by the "Target regions statistics" tool - that is, where broken pairs and multi-hit reads are included or ignored, depending upon what the user has specified in the wizard. On the x-axis is the reference position; on the y-axis is the coverage. The x-axis and y-axis values are identical to those found in the corresponding columns of the coverage table.

Click **Finish** to create the selected reports.

25.1.2 Coverage summary report

An example of a coverage report is shown in figure 25.3).

This figure shows only the top of the report. The full content is explained below:

Coverage summary This table shows overall coverage information.

Number target regions The number of targeted regions.

1 Target regions

1.1 Summary

Number target regions	439,473
Total length of target regions	80,017,566
Average coverage	31.9
Number of target regions with coverage below 30	364,318
Total length of regions of targets with coverage below 30	68,334,059

1.2 Fractions of targets with coverage at least 30

Number of targeted regions for which	Count	Percentage
>100% of the targeted region has coverage at least 30	75,155	17.00
>90% of the targeted region has coverage at least 30	102,823	23.00
>80% of the targeted region has coverage at least 30	128,142	29.00
>70% of the targeted region has coverage at least 30	151,199	34.00
>60% of the targeted region has coverage at least 30	172,099	39.00
>50% of the targeted region has coverage at least 30	191,463	43.00
>40% of the targeted region has coverage at least 30	207,965	47.00
>30% of the targeted region has coverage at least 30	221,911	50.00
>20% of the targeted region has coverage at least 30	233,754	53.00
>10% of the targeted region has coverage at least 30	244,462	55.00
>0% of the targeted region has coverage at least 30	439,473	100.00

Figure 25.3: The report with overviews of mapped reads.

Total length of target regions The sum of the size of all the targeted regions (this means it is calculated from the annotations alone and is not influenced by the reads).

Average coverage For each position in each target region the coverage is calculated, and stored (you can see the individual coverages in the **Coverage table** output, figure 25.8). The 'average coverage' is calculated by taking the mean of all the calculated coverages in all the positions in all target regions. Note that if the user has chosen **Ignore non-specific matches** or **Ignore broken pairs** these reads will not contribute to the coverage. Note also that bases in over-lapping paired reads will only be counted as 1.

Number of target regions with low coverage The number of target regions which have positions with a coverage that is below the user-specified **Minimum coverage** threshold.

Total length of target regions with low coverage The total length of these regions.

Fractions of targets with coverage at least... This table shows how many target regions have a certain percentage of the region above the user-specified **Minimum coverage** threshold.

Fractions of targets with coverage at least... A histogram presentation of the table above in **Fractions of targets with coverage at least...**

Coverage of target regions positions This plot shows the coverage level on the x axis, and the number of positions in the target regions with that coverage level.

Coverage of target regions positions A version of the histogram above zoomed in to the values that lie $\pm 3SDs$ from the median.

Minimum coverage of target regions This shows the percentage of the targeted regions that are covered by this many bases. The intervals can be specified in the dialog when running the analysis. Default is 1, 5, 10, 20, 40, 80, 100 times. In figure 25.4 this means that 26.58 % of the positions on the target are covered by at least 40 bases.

Targeted regions overview This section contains two tables: one that summarizes, for each reference sequence, information relating to the *reads* mapped, and one that summarizes, for each reference, information relating to the *bases* mapped (figures 25.4 and 25.5). Note that, for the table that is concerned with *reads*, reads in over-lapping pairs are counted individually. Also note that, for the table that is concerned with *bases*, bases in overlapping paired reads are counted only as one (Examples are given in figures 25.6 and figure 25.7).

Reference The name of the reference sequence.

Total mapped reads The total number of mapped reads on the reference, including reads mapped outside the target regions.

Mapped reads in targeted region Total number of reads in the targeted regions. Note that if there are overlapping regions, reads covered by two regions will be counted twice. If a read is only partially inside a targeted region, it will still count as a full read.

Specificity The percentage of the total mapped reads that are in the targeted regions.

Total mapped reads excl ingored The total number of mapped reads on the reference, including reads mapped outside the target regions, excluding the non-specific matches or broken pairs, if the user has switched on the option to ignore those.

Mapped reads in targeted region excl ingored Total number of reads in the targeted regions, excluding the non-specific matches or broken pairs, if the user has switched on the option to ignore those.

Specificity excl ingored The percentage of the total mapped reads that are in the targeted regions.

Reference The name of the reference sequence.

Total mapped bases The total number of mapped bases on the reference, including bases mapped outside the target regions.

Mapped bases in targeted region Total number of bases mapped within in the targeted regions. Note that if there are overlapping regions, bases included in two regions will be counted twice.

Specificity The percentage of the total mapped bases that are in the targeted regions.

Total mapped bases excl ingored The total number of mapped bases on the reference, including bases mapped outside the target regions, excluding the bases in non-specific matches or broken pairs, if the user has switched on the option to ignore those.

Mapped bases in targeted region excl ingored Total number of bases in the targeted regions, excluding the bases in non-specific matches or broken pairs, if the user has switched on the option to ignore those.

Specificity excluded The percentage of the total mapped bases that are in the targeted regions.

Distribution of target region length A plot of the length of the target regions, and a version of the plot where only the target region lengths that lie within +3SDs of the median target length are shown.

Base coverage The percentage of base positions in the target regions that are covered by respectively 0.1, 0.2, 0.3, 0.4, 0.5 and 1.0 times the mean coverage, where the mean coverage is the **average coverage** given in table 1.1. Because this is based on mean coverage, the numbers can be used for cross-sample comparison of the quality of the experiment.

Base coverage plot A plot showing the relationship between fold mean coverage and the number of positions. This is a graphical representation of the **Base coverage** table above.

Mean coverage per target position Three plots listing the mean coverage for each position of the targeted regions. The first plot shows coverage across the whole target, using a percentage of the target length on the x axis (to make it possible to have targets with different lengths in the same plot). This is reported for reverse and forward reads as well. In addition, there are two plots showing the same but with base positions on the x axis counting from the start and end of the target regions, respectively. These plots can be used to evaluate whether there is a general tendency towards lower coverage at the end of the targeted region, and whether there is a bias in terms of forward and reverse reads coverage.

Read count per %GC The plot shows the GC content of the reference sequence on the X-axis and the number of mapped reads on the Y-axis. This plot will show if there is a bias caused by higher GC-content in the sequence.

25.1.3 Per-region statistics

In addition to the summary report, you can see coverage statistics for each targeted region. This is reported as a track, and you can see the numbers by going to the table  view of the track. An example is shown in figure 25.6:

Chromosome The name is taken from the reference sequence used for mapping.

Region The targeted region.

Name The annotation name derived from the annotation (if there is additional information on the annotation, this is retained in this table as well).

Target region length The length of the region.

Target region length with coverage above... The length of the region that is covered by at least the **Minimum coverage** level provided in figure 25.1.

Percentage with coverage above... The percentage of the positions in the region with coverage at least the **Minimum coverage** level provided in figure 25.1.

1.5 Minimum coverage of targeted regions

Coverage	
1 x	95.06%
5 x	89.83%
10 x	82.40%
20 x	62.40%
40 x	26.58%
80 x	4.78%
100 x	2.34%

2 Targeted region overview

Reference	Total mapped reads	Mapped reads in targeted region	Specificity (%)	Total mapped reads excl ignored	Mapped reads in targeted region excl ignored	Specificity excl ignored (%)
1	4,338,296	2,168,439	49.98	4,338,296	2,168,439	49.98
2	4,929,239	2,384,422	48.37	4,929,239	2,384,422	48.37
3	2,495,513	1,242,395	49.79	2,495,513	1,242,395	49.79
4	2,214,025	768,447	34.71	2,214,025	768,447	34.71

Figure 25.4: The report: mapped reads.

Reference	Total mapped bases	Mapped bases in targeted region	Specificity (%)	Total mapped bases excl ignored	Mapped bases in targeted region excl ignored	Specificity excl ignored (%)
1	344,955,568	252,700,911	73.26	344,955,568	252,700,911	73.26
2	388,499,642	276,219,534	71.10	388,499,642	276,219,534	71.10
3	196,369,744	144,978,039	73.83	196,369,744	144,978,039	73.83
4	173,524,865	91,208,669	52.56	173,524,865	91,208,669	52.56

Figure 25.5: The report: mapped bases.

Read count Number of reads that cover this region. Note that reads that only cover the region partially are also included. Note that reads in over-lapping pairs are counted individually (see figures 25.6 and figure 25.7).

Base count The number of bases in the reads that are covering the target region. Note that bases in overlapping pairs are counted only once (see figures 25.6 and figure 25.7).

%GC The GC content of the region.

Min coverage The lowest coverage in the region.

Max coverage The highest coverage in the region.

Mean coverage The average coverage in the region.

Median coverage The median coverage in the region.

Zero coverage bases The number of positions with no coverage.

Mean coverage (excluding zero coverage) The average coverage in the region, excluding any zero-coverage parts.

Median coverage (excluding zero coverage) The median coverage in the region, excluding any zero-coverage parts.

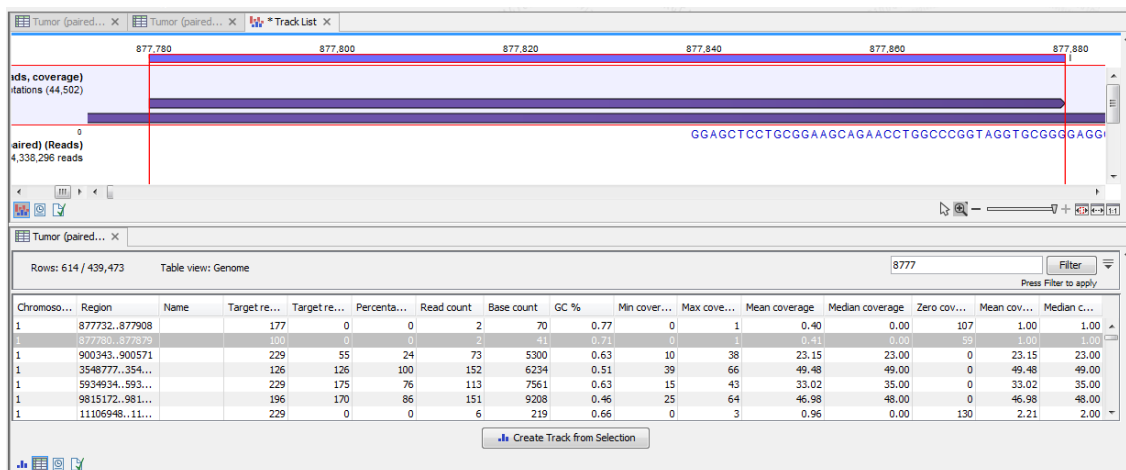

Figure 25.6: A track list containing the target region coverage track and reads track. The target region coverage track has been opened from the track list and is shown in table view. Detailed information on each region is displayed. Only one paired read maps to the region selected.

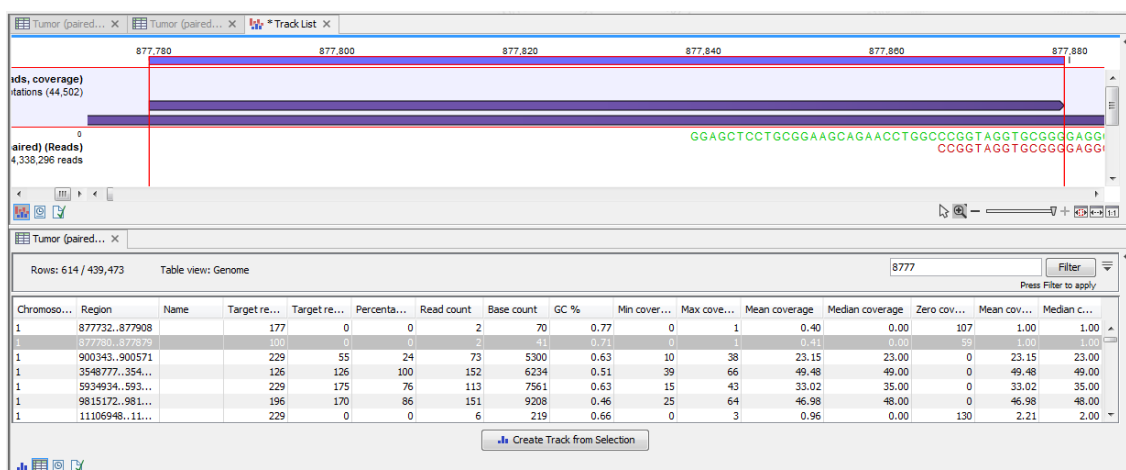

Figure 25.7: The same data as shown in figure 25.6, but now the Disconnect paired reads option in the side-panel of the reads track has been ticked, so that the two reads in the paired read are shown disconnected.

In the shown figure, the coverage table is shown in split view with a track list. The coverage track has been opened from the track list by clicking once on the name found in the left side in the track list. When opening a read mapping in split view from a track list, the two views are linked, this means that when you click on an entry in the table, this position will be brought into focus in the track list.

For information about how to create a track list, please see section 23.1.

25.1.4 Coverage table

Besides standard information such as position etc, the coverage table (figure 25.8) lists the following information for each position in the whole target:

Name The name of the target region.

Target region position The name of the target region.

Reference base The base in the reference sequence.

Coverage The number of bases mapped to this position. Note that bases in over-lapping pairs are counted only once. Also note that if the user has chosen the **Ignore non-specific matches** or **Ignore broken pairs** options, these reads will be ignored. (see discussion on coverage in section 24.2.8).

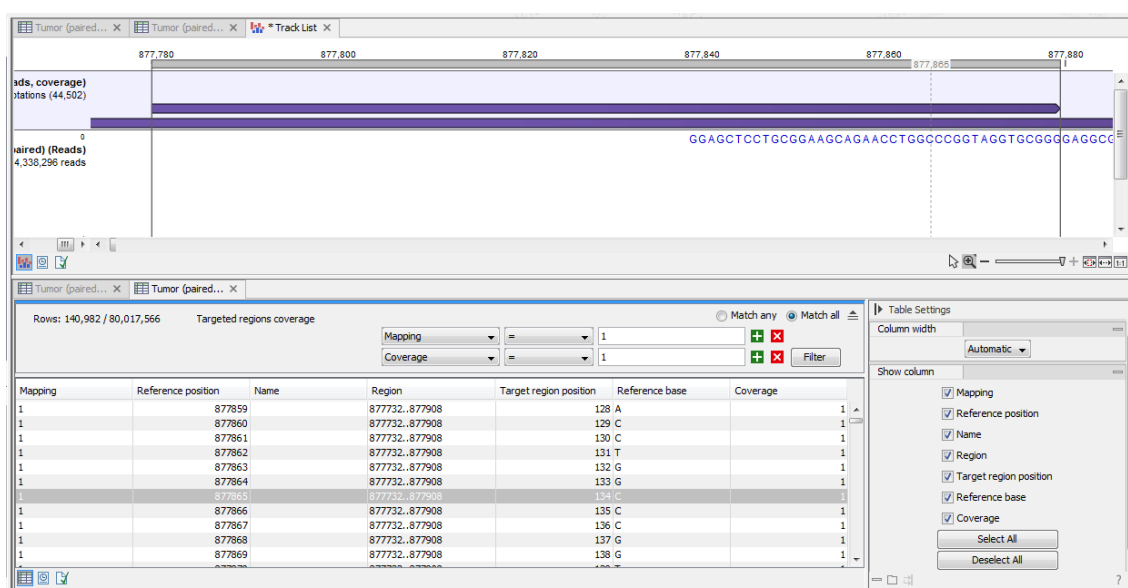

Figure 25.8: The targeted region coverage table for the same region as shown in same as shown in figures 25.6 and figure 25.7.

In the shown figure, the coverage table is shown in split view with a track list. The coverage track has been opened from the track list by clicking once on the name found in the left side in the track list. When opening a read mapping in split view from a track list, the two views are linked, this means that when you click on an entry in the table, this position will be brought into focus in the track list.

For information about how to create a track list, please see section 23.1.

25.1.5 Coverage graph

The coverage graph is a graphical presentation of the coverage for each position in all the targets (positions outside the targets will have the value 0). The values are calculated by the "Target regions statistics" tool, and are presented with the reference position on the x-axis and the coverage on the y-axis (see figure 25.9). The x-axis and y-axis values are identical to those found in the columns of the coverage table.

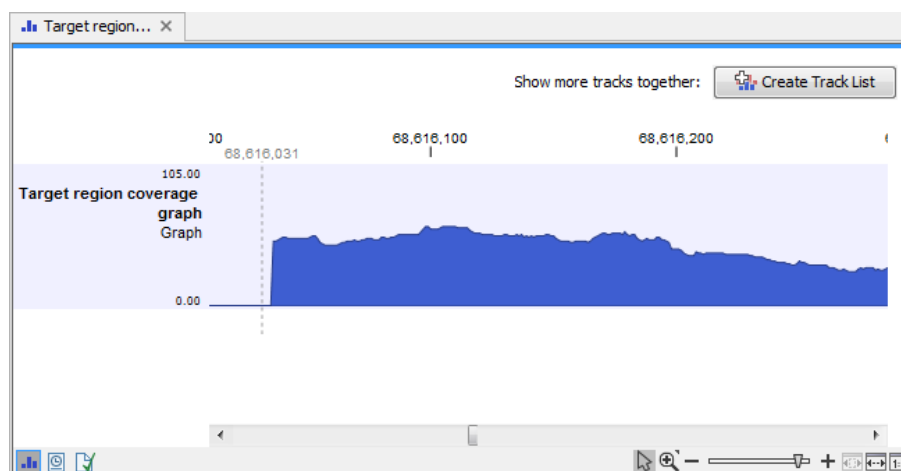

Figure 25.9: An example of a targeted region coverage graph.

25.2 InDels and Structural Variants

The InDels and Structural Variants tool is designed to identify structural variants such as insertions, deletions, inversions, translocations and tandem duplications in read mappings. The tool relies *exclusively* on information derived from unaligned ends (also called 'soft clippings') of the reads in the mappings. This means that:

- The tool will detect NO structural variants if there are NO reads with unaligned ends in the read mapping.
- Read mappings made with the CLC 'Map reads to reference' tool with the 'global' option switched on will have NO unaligned ends and the InDels and Structural Variants tool will thus find NO structural variants on these. (The 'global' option means that reads are aligned in their entirety - irrespectively of whether that introduces mismatches towards the ends of the reads. In the 'local' option such reads will be mapped with unaligned ends).
- Read mappings based on really short reads (say, below 35 bp) are not likely to produce many reads with unaligned ends of any useful length, and the tool is thus not likely to produce many structural variant predictions for these read mappings.
- Read mappings generated with the Large Gap Read Mapper are NOT optimal for the detection of structural variants with this tool. This is due to the fact that, the Large Gap Read Mapper will map some reads with (large) gaps, that would be mapped with unaligned ends with standard read mappers, and thus will leave a weaker unaligned end signal in the mappings for the Structural Variation tool to work with.

In its current version the InDels and Structural Variants tool has the following known limitations:

- It will only detect intra-chromosomal structural variants.

25.2.1 How to run the InDels and Structural Variants tool

To start the structural variant detection:

Toolbox | Resequencing (🚚) | InDels and Structural Variants tool (🔍)

This will open up a dialog. Select the read mapping of interest as shown in figure 25.10 and click on the button labeled **Next**.

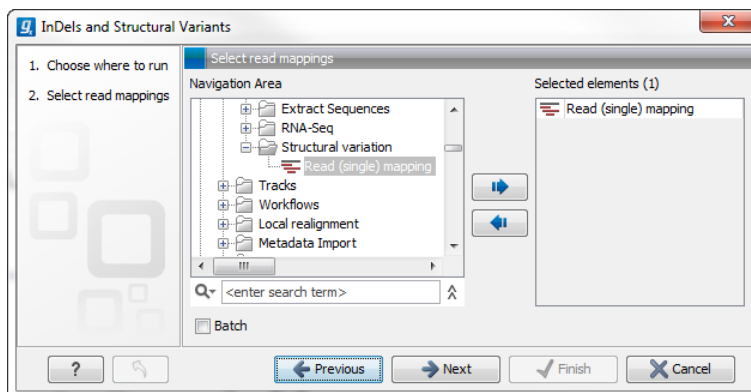

Figure 25.10: Select the read mapping of interest.

The next wizard step (Figure 25.11) is concerned with specifying parameters related to the algorithm used for calling structural variants. The algorithm first identifies positions in the mapping(s) with an excess of reads with left (or right) unaligned ends. Once these positions and the consensus sequences of the unaligned ends are determined, the algorithm maps the determined consensus sequences to the reference sequence around other positions with unaligned ends. If mappings are found that are in accordance with a 'signature' of a structural variant, a structural variant is called. For further details about the algorithm see section 25.2.3.

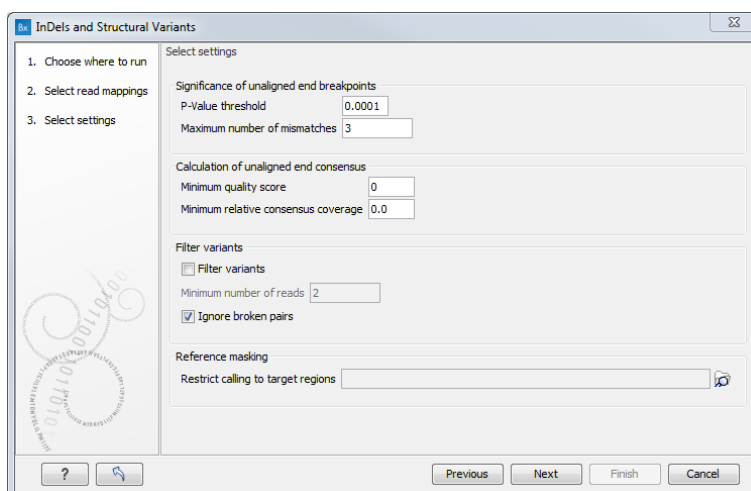

Figure 25.11: Select the relevant settings.

The '**Significance of unaligned end breakpoints**' parameters are concerned with when a position with unaligned ends should be considered by the algorithm, and when it should be ignored:

- **P-value threshold:** Only positions in which the fraction of reads with unaligned ends is sufficiently high will be considered. The 'P-value threshold' determines the cut-off value in a Binomial Distribution for this fraction. The higher the P-value threshold is set, the more unaligned breakpoints will be identified.
- **Maximum number of mismatches:** The 'Maximum number of mismatches' parameter determines which reads should be considered when inferring unaligned end breakpoints. Poorly map reads tend to have many mis-matches and unaligned ends, and it may be

preferable to let the algorithm ignore reads with too many mis-matches in order to avoid false positives and reduce computational time. On the other hand, if the allowed number of mis-matches is set too low, unaligned end breakpoints in proximities of other variants (e.g. SNVs) may be lost. Again, the higher the number of mis-matches allowed, the more unaligned breakpoints will be identified.

The **Calculation of unaligned end consensus** parameters can improve the calculation of the unaligned end consensus by removing bases according to:

- **Minimum quality score:** quality score under which bases should be ignored.
- **Minimum relative consensus coverage:** consensus coverage threshold under which bases should be ignored. The relative consensus coverage is calculated by taking the coverage at the current nucleotide position and dividing by the maximum coverage obtained along the unaligned ends upstream from this position. When the value thus calculated falls below the specified threshold, consensus generation stops. The idea behind the "Minimum relative consensus coverage" option is to stop consensus generation when dramatic drops in coverage are observed. For example, a drop from 1000 coverage to 10 coverage would give a relative consensus coverage of $10/1000 = 0.01$.

The **'Filter variants'** parameters are concerned with the amount of evidence for each structural variant required for it to be called:

- **Filter variants:** When the **Filter variants** box is checked, only variants that are inferred by breakpoints that *together* are supported by at least the specified **Minimum number of reads** will be called.
- **Ignore broken pairs:** This option is checked by default, but it can be unchecked to include variants located in broken pairs.

'Reference masking' allows specification of target regions:

- **Restrict calling to target regions:** When specifying a target region track only reads that overlap with at least one of the targets will be examined when the unaligned end breakpoints are identified. Hence only breakpoints that fall within, or in close proximity of, the targets will be identified (a read may overlap a target, but have an unaligned end outside the target - these are also identified and therefore breakpoints outside, but in the proximity of the target). The runtime will be decreased when you specify a target track as compared to when you do not.

Note! As the set of identified unaligned end breakpoints differs between runs where a target region track has been specified and where it has not, the set of predicted indels and structural variants is also likely to differ. This is because the indels and structural variants are predicted from the mapping patterns of the unaligned ends at the set of identified breakpoints. This is also the case even if you restrict the comparison to only involve the indels and structural variants detected within the target regions. You cannot expect these to be exactly the same but you can expect a large overlap.

Specify these settings and click **Next**. The "Results handling" dialog (Figure 25.12) will be opened. The Indels and Structural variants tool has the following output options:

- **Create report** When ticked, a report that summarizes information about the inferred breakpoints and variants is created.
 - **Create breakpoints** When ticked, a track containing the detected breakpoints is created.
 - **Create InDel variants** When ticked, a variant track containing the detected indels that fulfill the requirements for being 'variants' is created. These include:
 - the detected insertions for which the allele sequence is inferred, but not those for which it is not known, or only partly known. As the algorithm relies on mapping two unaligned ends against each other for detecting insertions *with inferred allele sequence*, the maximum length of these that can potentially be detected depends on (1) the read length and (2) the "length fraction" parameter of the read mapper. With current read lengths and default settings you are unlikely to get insertions *with inferred allele sequence* larger than a couple of hundred, and hence will not see insertions in this track larger than that.
 - medium sized deletions (those between six and 200 bp). All other deletions are put in the "Structural variants" track. The reason for not including all detected deletions in the indel track is that the main intended use of this track is to guide re-alignment. In our experience, the re-alignment algorithm performs best when only including the medium sized events. Notice that, in contrast to insertions, there is no upper limit on the length of deletions *with inferred allele sequence* that the algorithm can detect. This is because the allele sequence is trivial for deletions, whereas for insertions it must be inferred from the nucleotides in the unaligned ends.
- See section 25.12.1 for a definition of the requirements for 'variants'. Note that insertions and deletions that are not included in the InDel track, will be present in the 'Structural variants track' (described below).
- **Create structural variations** When ticked, a track containing the detected structural variants is created, including the insertions *with unknown allele sequence* and the deletions that are not included in the "InDel" track.

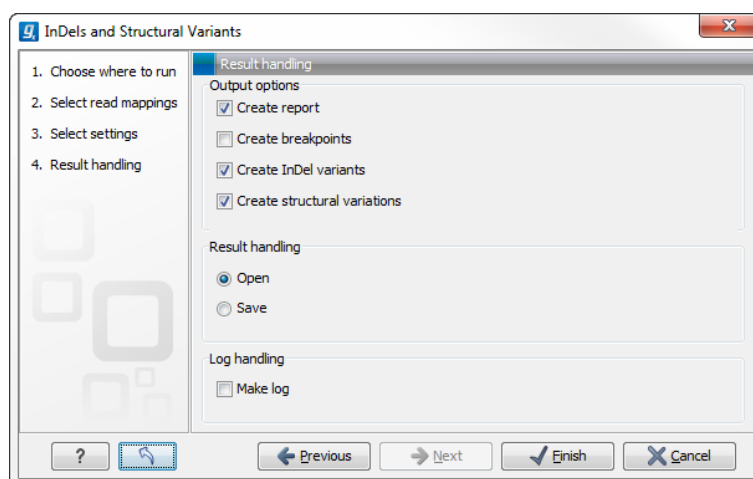

Figure 25.12: Select output formats.

An example of the output from the InDels and Structural Variant tool is shown in Figure 25.13. The output is described in detail in the next section (section 25.2.2).

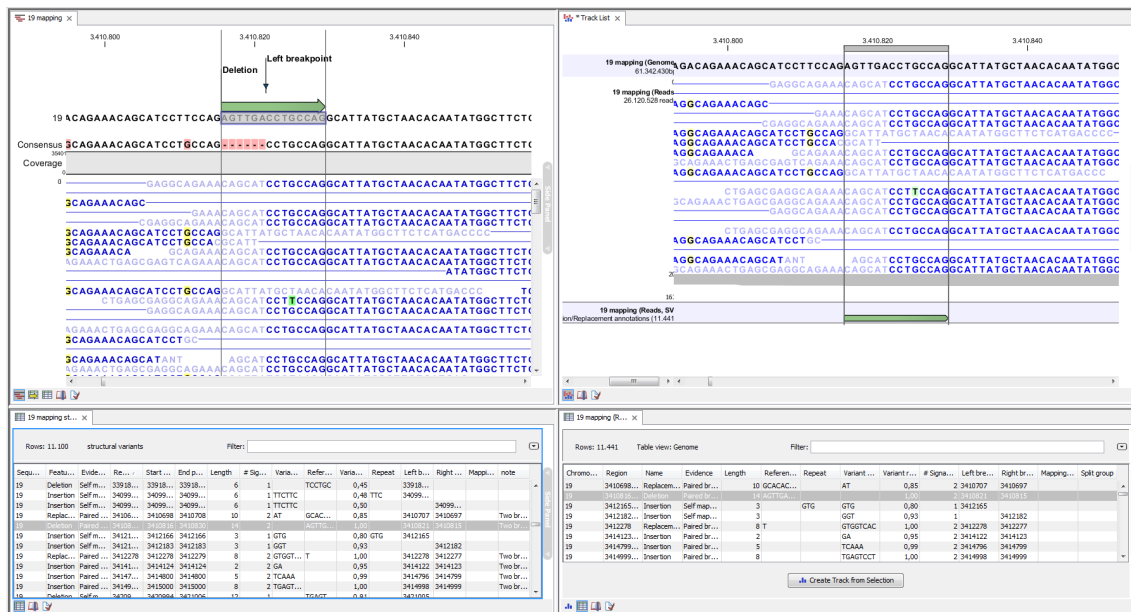

Figure 25.13: Example of the result of an analysis on a standalone read mapping (to the left) and on a reads track (to the right).

25.2.2 The Structural Variants and InDels output

The report

The report gives an overview of the numbers and types of structural variants found in the sample. It contains

- A table with a row for each reference sequence, and information on the number of breakpoint signatures and structural variants found.
- A table giving the total number of left and right unaligned end breakpoint signatures found, and the total number of reads supporting them.
- A distribution of the logarithm of the sequence complexity of the unaligned ends of the left and right breakpoint signatures (see section 25.2.7 for how the complexity is calculated).
- A distribution of the length of the unaligned ends of the left and right breakpoint signatures.
- A table giving the total number of the different types of structural variants found.
- Plots depicting the distribution of the lengths of structural variants identified.

The Breakpoints track (BP):

The breakpoints track contains a row for each called breakpoint with the following information:

- 'Chromosome': The chromosome on which the breakpoint is located.
- 'Region': The location on the chromosome of the breakpoint.
- 'Name': The type of the breakpoint ('left breakpoint' or 'right breakpoint').

- 'p-value': The p-value (in the Binomial distribution) of the unaligned end breakpoint.
- 'Unaligned': The consensus sequence of the unaligned ends at the breakpoint.
- 'Unaligned length': The length of the consensus sequence of the unaligned ends at the breakpoint.
- 'Mapped to self': If the unaligned end sequence at the breakpoint was found to map back to the reference in the vicinity of the breakpoint itself, a 'Deletion' or 'Insertion' based on 'self-mapping' evidence is called. This column will contain 'Deletion' or 'Insertion' if that is the case, or be empty if the unaligned end did not map back to the reference in the vicinity of the breakpoint itself.
- 'Perfect mapped': The number of 'perfect mapped' reads. This number is intended as a proxy for the number of reads that fit with the reference sequence. When calculating this number we consider all reads that extend across the breakpoint. We ignore reads that are non-specifically mapped, in a broken pair, or has more than the **maximum number of mismatches**. A read is perfectly mapped if (1) it has no insertions or deletions (mismatches are allowed) and (2) it has no unaligned end.
- 'Not perfect mapped': The number of 'not perfect mapped' reads. This number is intended as a proxy for the number of reads that fit with the predicted indel. When calculating this number we consider all reads that extend across the breakpoint or that has an unaligned end starting at the breakpoint. We ignore reads that are non-specifically mapped, in a broken pair, or has more than the **maximum number of mismatches**. A read is not perfect mapped if (1) it has an insertion or deletion or (2) it has an unaligned end.
- 'Fraction non-perfectly mapped': the 'Non perfect mapped' divided by the 'Non perfect mapped' + 'Perfect mapped'.
- 'Sequence complexity': The sequence complexity of the unaligned end of the breakpoint (see section 25.2.7 for how the sequence complexity is calculated).
- 'Reads': The number of reads supporting the breakpoint.

Note that typically, breakpoints will be found for which it is not possible to infer a structural variant. There may be a number of reasons for that: (1) the unaligned ends from which the breakpoint signature was derived might not be caused by an underlying structural variant, but merely be due to read mapping issues or noise, or (2) the breakpoint(s) which the detected breakpoint should have been matched to was/were not detected, and therefore no matching breakpoint(s) were found. Breakpoints may go un-detected either because of lack of coverage in the breakpoint region or because they are located within regions with exclusively non-uniquely mapped reads (only unaligned ends of uniquely mapping reads are used).

The InDel variants track (InDel):

The InDel variants track contains a row for each of the called insertions or deletions that *fulfills the requirements for being of a 'variant' type* (see section 25.12.3 for a description of the variant types "Insertion" and "Deletion"). These are the small to medium sized insertions and deletions (up to 200 bp in length) for which the algorithm was able to identify the allele sequence (that is, the exact inserted sequence, or the exact deleted sequence). For insertions, the full allele

sequence is found from the unaligned ends of mapped reads. For some insertions the length and allele sequence cannot be determined and as these do not fulfill the requirements of a 'variant', they do not qualify for representation in the 'InDel variant' track but instead appear in the Structural Variants track (see below). The information provided for each of the indels in the InDel variant track is the 'Chromosome', 'Region', 'Type', 'Reference', 'Allele', 'Reference Allele', 'Length' and 'Zygosity' columns that are provided for all variants (see section 25.12.1). In addition the following information, which is primarily intended to allow the user to assess the degree of evidence supporting each predicted indel, is provided:

- 'Evidence': The mapping evidence on which the call of the indel was based. This may be either 'Self mapped', 'Paired breakpoint', 'Cross mapped breakpoint' or 'Tandem duplication' depending on the mapping signature of the unaligned ends of the breakpoint(s) from which the indel was inferred.
- 'Repeat': The algorithm attempts to identify if the variant sequence contains perfect repeats. This is done by searching the region around the structural variant for perfect repeat sequences. The region searched is 3 times the length of variant around the insertion/deletion point. The maximum repeat length searched for is 10. If a repeat sequence is found, the repeated sequence is given in this column. If not, the column is empty.
- 'Variant ratio': This column contains the sum of the 'Non perfect mapped' reads for the breakpoints used to infer the indel, divided by the sum of the 'Non perfect mapped' and 'Perfect mapped' reads for the breakpoints used to infer the indel (see section the description above of the breakpoints track). This fraction is intended to give a hint towards the zygosity of the indel. The closer the value to 1, the higher the likelihood that the variant is homozygous.
- '# Reads': The total number of reads supporting the breakpoints from which the indel was constructed.
- 'Sequence complexity': The sequence complexity of the unaligned end of the breakpoint (see section 25.2.7). Indels with higher complexity are typically more reliable than those with low complexity.

The 'Zygosity' field is set to 'Homozygous' if the 'Variant ratio' is 0.80 or above, and 'Heterozygous' otherwise.

The Structural variants track (SV):

The Structural variants track contains a row for each of the called Structural variants that is not already reported in the InDel track. It contains the following information:

- 'Chromosome': The chromosome on which the structural variant is located.
- 'Region': The location on the chromosome of the structural variant.
- 'Name': The type of the structural variant ('deletion', 'insertion', 'inversion', 'replacement', 'translocation' or 'complex').

- 'Evidence': The breakpoint mapping evidence ('that is, the 'unaligned end 'signature') on which the call of the structural variant was based. This may be either 'Self mapped', 'Paired breakpoint', 'Cross mapped breakpoints', 'Cross mapped breakpoints (invalid orientation)', 'Close breakpoints', 'Multiple breakpoints' or 'Tandem duplication', depending on which type of signature that was found.
- 'Length': the length of the allele sequence of the structural variant. Note that the length of variants for which the allele sequence could not be determined is reported as 0 (e.g insertions inferred from 'Close breakpoints').
- 'Reference sequence': The sequence of the reference in the region of the structural variant.
- 'Variant sequence': The allele sequence of the structural variant if it is known. If not, the column will be empty.
- 'Repeat': The same as in the InDel track.
- 'Variant ratio': The same as in the InDel track.
- 'Signatures': The number of unaligned breakpoints involved in the signature of the structural variant. In most cases these will be pairs of breakpoints, and the value is 2, however some structural variants that have signatures involving more than two breakpoint (See section 25.2.6). Typically structural variants of type 'complex' will be inferred from more than 2 breakpoint signatures.
- 'Left breakpoints': The positions of the 'Left breakpoints' involved in the signature of the structural variant.
- 'Right breakpoints': The positions of the 'Right breakpoints' involved in the signature of the structural variant.
- 'Mapping scores fraction': The mapping scores of the unaligned ends for each of the breakpoints. These are the similarity values between the unaligned end and the region of the reference to which it was mapped. The values lie between 0 and 1. The closer the value is to 1, the better the match, suggesting better reliability of the inferred variant.
- 'Reads': The total number of reads supporting the breakpoints from which the indels was constructed.
- 'Sequence complexity': The sequence complexity of the unaligned end of the breakpoint (see section 25.2.7).
- 'Split group': Some structural variants extend over a very large a region. For these visualization is challenging, and instead of reporting them in a single row we split them in multiple rows - one for each 'end' of the variant. To allow the user to see which of these 'split features' belong together, we give features that belong to the same structural variant a common 'split group' identifier. If the column is empty the structural variant is not split, but contained within a single row.

25.2.3 The InDels and Structural Variants detection algorithm

The Indels and Structural Variants detection algorithm has two steps:

1. Identify 'breakpoint signatures': First, the algorithm identifies positions in the mapping(s) with an excess of reads with left (or right) unaligned ends. For each of these, it creates a Left breakpoint (LB) or Right breakpoint (RB) signature.
2. Identify 'structural variant signatures': Secondly, the algorithm creates structural variant signatures from the identified breakpoint signatures. This is done by mapping the consensus unaligned ends of the identified LB and RB signatures to selected areas of the references as well as to each other. The mapping patterns of the consensus unaligned ends are examined and structural variant annotations consistent with the mapping patterns are created.

The two steps of the algorithm are described in detail in sections 25.2.4 and 25.2.5.

25.2.4 The InDels and Structural Variants detection algorithm - Step 1: Creating Left- and Right breakpoint signatures

In the first step of the InDels and Structural Variants detection algorithm points in the read mapping are identified which have a significant proportion of reads mapped with unaligned ends. There are typically numerous reads with unaligned ends in read mappings – some are due to structural variants in the sample relative to the reference, others are due to poorly mapped, or poor quality reads. An example is given in figure 25.14. In order to make reliable predictions, attempts must be made to distinguish the unaligned ends caused by noisy read(mappings) from those caused by structural variants, so that the signal from the structural variants comes through as clearly as possible – both in terms of where the 'significant' unaligned ends are and in terms of what they look like.



Figure 25.14: Example of a read mapping containing unaligned ends with three unaligned end signatures.

To identify positions with a 'significant' portion of 'consistent' unaligned end reads we first estimate 'null-distributions' of the fractions of left and right unaligned end reads at each position in the read mapping, and subsequently use these distributions to identify positions with an 'excess' of unaligned end reads. In these positions we create a Left (LB) or Right (RB) breakpoint signature. To estimate the null-distributions we:

1. Calculate the coverage, c_i , in each position, i of all uniquely mapped reads (Non-specifically mapped reads are ignored. Furthermore, for paired read data sets, only intact paired reads pairs are considered – broken paired reads are ignored).

2. Calculate the coverage in each position of 'valid' reads with a starting left unaligned end, l_i (of minimum consensus length 3bp).
3. Calculate the coverage in each position of 'valid' reads with a starting right unaligned end, r_i (of minimum consensus length 3bp).

We then use the observed fractions of 'Left unaligned ends' ($\sum_i l_i / \sum_i c_i$) and 'Right unaligned ends' ($\sum_i r_i / \sum_i c_i$) as frequencies in binomial distributions of 'Left unaligned end' and 'Right unaligned end' read fractions. We go through each position in the read mapping and examine it for an excess of left (or right) unaligned end reads: if the probability of obtaining the observed number of left (or right) unaligned ends in a position with the observed coverage, is 'small', a Left breakpoint signature (LB), respectively Right breakpoint signature (RB), is created.

The two user-specified settings 'The P-value threshold' and the 'Maximum number of mismatches' determine which breakpoint signatures the algorithm will detect (see section 25.2.1 and Figure 25.11). The p-value is used as a cutoff in the binomial distributions estimated above: if the probability of obtaining the observed number of left (or right) unaligned ends in a position with the observed coverage, is smaller than the user-specified cut-off, a Left breakpoint signature (LB), respectively Right breakpoint signature (RB), is created. The 'Maximum number of mis-matches' parameter is used to determine which reads are considered 'valid' unaligned end reads. Only reads that have at most this number of mis-matches in their aligned parts are counted. The higher these two values are set, the more breakpoints will be called. The more breakpoints are called, the larger the search space for the Structural variation detection algorithm, and thus the longer the computation time.

In figure 25.14, three unaligned end signatures are shown. The left-most LB signature is called only when the p-value cut-off is chosen high (0.01 as opposed to 0.0001).

25.2.5 The InDels and Structural Variants detection algorithm - Step 2: Creating Structural variant signatures

In the second step of the InDels and Structural Variants detection algorithm the unaligned end 'breakpoint signatures' (identified in step 1) are used to derive 'structural variant signatures'. This is done by:

1. Generating a consensus sequence of the reads with unaligned ends at each identified breakpoint.
2. Mapping the generated consensus sequences against the reference sequence in the regions around *other* identified breakpoints ('cross-mapping').
3. Mapping the generated consensus sequences of breakpoints that are *near each other against each other* ('aligning').
4. Mapping the generated consensus sequences against the reference sequence in the *region around the breakpoint itself* ('self-mapping').
5. Considering the breakpoints whose unaligned end consensus sequences are found to cross map against each other together, and compare their mapping patterns to the set of theoretically expected 'structural variants signatures' (see section 25.2.6).

6. Creating a 'structural variant signature' for each of the groups of breakpoints whose mapping patterns were in accordance with one of the expected 'structural variants signatures'.

A structural variant is called for each of the created 'structural variant signatures'. For each of the groups of breakpoints whose mapping patterns were NOT in accordance with one of the expected 'structural variants signatures', we call a structural variant of type 'complex'.

The steps above require a number of decisions to be made regarding (1) When is the consensus sequence reliable enough to work with?, and (2) When does an unaligned end map well enough that we will call it a match? The algorithm uses a number of hard-coded values when making those decisions. The values are described below.

Algorithmic details

- **Generating a consensus:** The consensus of the unaligned ends is calculated by simple alignment without gaps. Having created the consensus, we exclude the unaligned ends which differ by more than 20% from the consensus, and recalculate the consensus. This prevents 'spuriously' unaligned ends that extend longer than other unaligned ends from impacting the tail of the consensus unaligned end.
- **Mapping of the consensus:**
 - **'Cross mapping':** When mapping the consensus sequences against the reference sequence around other breakpoints we require that:
 - * The consensus is at least 16 bp long.
 - * The score of the alignment is at least 70% of the maximal possible score of the alignment.
 - **'Aligning':** When aligning the consensus sequences two closely located breakpoints against each other we require that:
 - * The breakpoints are within a 100 bp distance of each other.
 - * The overlap in the alignment of the consensus sequences is least 4 nucleotides long.
 - **'Self-mapping':** When mapping the consensus sequences of breakpoints against the reference sequence in a region around the breakpoint itself we require that:
 - * The consensus is at least 9 bp long.
 - * A match is found within 400 bp window of the breakpoint.
 - * The score of the alignment is at least 90% of the maximal possible score of the alignment of the part of the consensus sequence that does not include the variant allele part.

25.2.6 Theoretically expected structural variant signatures

Different types of structural variants will leave different 'signatures' in terms of the mapping patterns of the unaligned ends. The 'structural variant signatures' of the set of structural variants that are considered by the Indels and Structural variant tool are drawn in figures [25.15](#), [25.16](#), [25.17](#), [25.18](#), [25.19](#), [25.20](#), [25.21](#), [25.22](#) and [25.23](#).

Deletion - cross mapped/paired breakpoints evidence

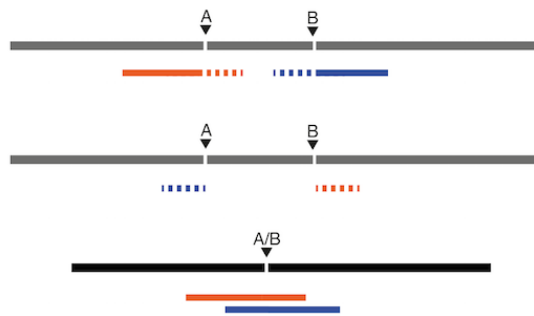

Sample reads map to reference genome. Unaligned ends detected between points A and B.

Unaligned ends map to reference at the opposite sides of points A and B.

Conclusion: Sample genome contains a deletion between A and B.

Figure 25.15: A deletion with cross-mapping breakpoint evidence.

Deletion - selfmapped evidence

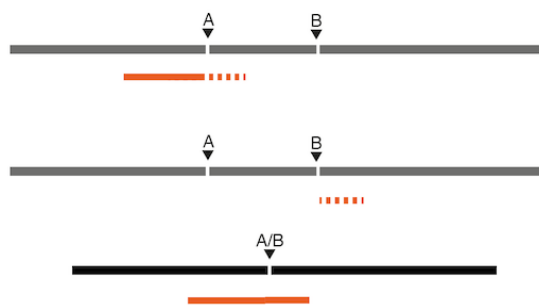

Sample read maps to reference genome before point A. Unaligned end detected between points A and B.

Unaligned end maps to reference after point B.

Conclusion: Sample genome contains a deletion between A and B.

Figure 25.16: A deletion with selfmapping breakpoint evidence.

Insertion - close breakpoints evidence

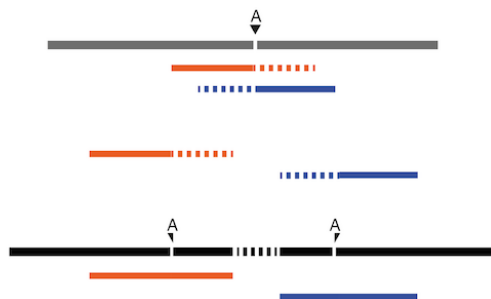

Sample reads map to reference genome at point A. Unaligned end detected at either side of point A.

Unaligned ends do not map to each other.

Conclusion: Sample genome contains an insertion. The inserted sequence cannot be fully deduced.

Figure 25.17: An insertion with close breakpoint evidence.

Insertion - crossedmapped evidence

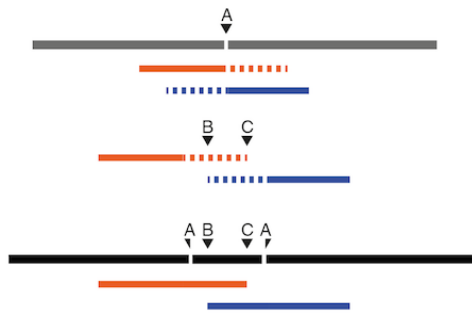

Sample reads map to reference genome at point A.
Unaligned end detected at either side of point A

Unaligned ends map to each other between points B and C

Conclusion: Sample genome contains an insertion.
The inserted sequence can be deduced

Figure 25.18: An insertion with cross-mapped breakpoints evidence.

Insertion - selfmapped evidence

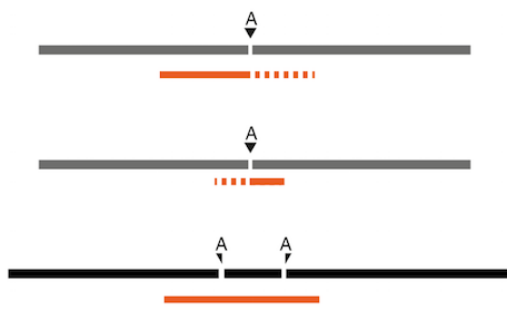

Sample reads map to reference genome before point A.
Unaligned end detected after point A.

Terminal part of the unaligned end maps at other side of A.

Conclusion: Sample genome contains an insertion.
The inserted sequence can be deduced.

Figure 25.19: An insertion with selfmapped breakpoint evidence.

Insertion - tandem duplication

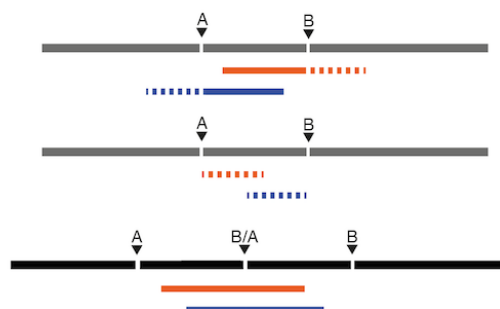

Sample reads map to the reference genome between points A and B.
Unaligned ends are detected before A and after B.

Unaligned ends map before B and after A.

Conclusion: Sample genome contains a tandem duplication insertion.

Figure 25.20: An insertion with breakpoint mapping evidence corresponding to a 'Tandem duplication'.

Inversion - crossmapped/paired breakpoints

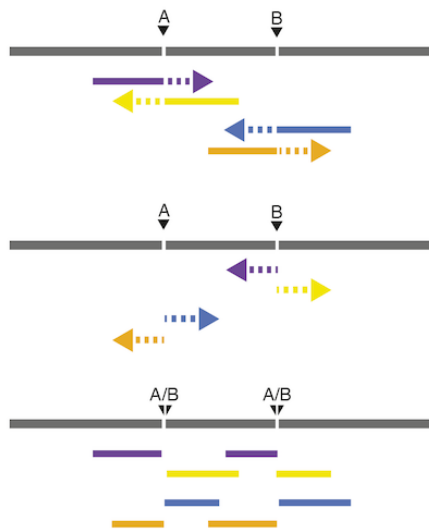

Unaligned ends are detected at two positions.

Unaligned ends from point A map at B reverse translated and vice versa.

Conclusion: The sample genome contains an inversion of the region between A and B.

Figure 25.21: *The unaligned end mapping pattern of an inversion.*

Replacement

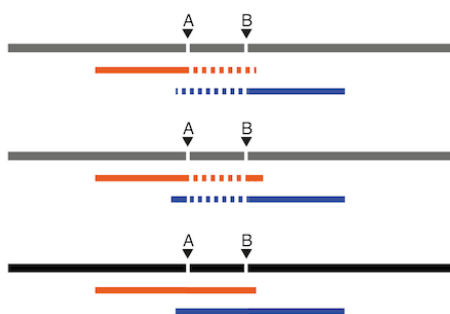

Unaligned ends are detected between A and B.

Unaligned ends map to each other. The consensus alignment of the reads map to the reference with a replaced internal sequence.

Conclusion: Sample genome contains a replacement between points A and B.

Figure 25.22: *The unaligned end mapping pattern of a replacement.*

Translocation

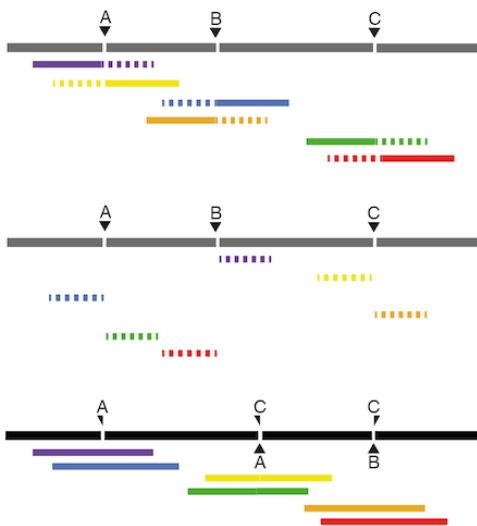

Unaligned ends are detected at three positions.

The unaligned ends map to other places around the same three positions in the specific pattern shown here.

Conclusion: The sample genome contains a translocation (the part between A and B in the sample has been deleted, and re-inserted at the point C in the sample).

Figure 25.23: *The unaligned end mapping pattern of a translocation.*

25.2.7 How sequence complexity is calculated

The sequence complexity of an unaligned end is calculated as the product of 'the observed vocabulary-usages' divided by 'the maximal possible vocabulary-usages', for word sizes from one to seven. When multiple breakpoints are used to construct a structural variant, the complexity is calculated as the product of the individual sequence complexities of the breakpoints constituting the structural variant.

The observed vocabulary usage for word size, k , for a given sequence is the number of different "words" of size k that exist in that sequence. The maximal possible vocabulary usage for word size k for a given sequence is the maximal number of different words of size k that can possibly be observed in a sequence of a given length. For DNA sequences, the set of all possible letters in such words is four, that is, there are four letters that represent the possible nucleotides: A, C, G and T. The calculation is most easily described using an example.

Consider the sequence CAGTACAG. In this sequence we observe:

- 4 different words of size 1 ('A', 'C', 'G' and 'T').
- 5 different words of size 2 ('CA', 'AG', 'GT', 'TA' and 'AC') Note that 'CA' and 'AG' are found twice in this sequence.
- 5 different words of size 3 ('CAG', 'AGT', 'GTA', 'TAC' and 'ACA') Note that 'CAG' is found twice in this sequence.
- 5 different words of size 4 ('CAGT', 'AGTA', 'GTAC', 'TACA' and 'ACAG')
- 4 different words of size 5 ('CAGTA', 'AGTAC', 'GTACA' and 'TACAG')
- 3 different words of size 6 ('CAGTAC', 'AGTACA' and 'GTACAG')
- 2 different words of size 7 ('CAGTACA' and 'AGTACAG')

Note that we only do the calculations for word sizes up to 7, even when the unaligned end is longer than this.

Now we consider the maximal possible number of words we could observe in a DNA sequence of this length, again restricting our considerations to word lengths of 7.

- Word size of 1: The maximum number of different letters possible here is 4, the single characters, A, G, C and T. There are 8 positions in our example sequence, but there are only 4 possible unique nucleotides.
- Word size of 2: The maximum number of different words possible here is 7. For DNA generally, there is a total of 16 different dinucleotides (4×4). For a sequence of length 8, we can have a total of 7 dinucleotides, so with 16 possibilities, the dinucleotides at each of our 7 positions could be unique.
- Word size of 3: The maximum number of different words possible here is 6. For DNA generally, there is a total of 64 different trinucleotides ($4 \times 4 \times 4$). For a sequence of length 8, we can have a total of 6 trinucleotides, so with 64 possibilities, the trinucleotides at each of our 6 positions could be unique.

- Word size of 4: The maximum number of different words possible here is 5. For DNA generally, there is a total of 256 different dinucleotides ($4 \times 4 \times 4 \times 4$). For a sequence of length 8, we can have a total of 5 quaternucleotides, so with 256 possibilities, the quaternucleotides at each of our 5 positions could be unique.

We then continue, using the logic above, to calculate a maximum possible number of words for a word size of 5 being 4, a maximum possible number of words for a word size of 6 being 3, and a maximum possible number of words for a word size of 7 being 2.

Now we can compute the complexity for this 7 nucleotide sequence by taking the number of different words we observe for each word length from 1 to 7 nucleotides and dividing them by the maximum possible number of words for each word length from 1 to 7. Here that gives us:

$$(4/4)(5/7)(5/6)(5/5)(4/4)(3/3)(2/2) = 0.595$$

As an extreme example of a sequence of low complexity, consider the 7 base sequence AAAAAAA. Here, we would get the complexity:

$$(1/4)(1/6)(1/5)(1/4)(1/3)(1/2)(1/1) = 0.000347$$

25.3 Coverage analysis

The coverage analysis tool is designed to identify regions in read mappings with unexpectedly low or high coverage. Such regions may be indicative of a deletion or an amplification in the sample relative to the reference. The algorithm fits a Poisson distribution to the observed coverage in the positions of the mapping. This distribution is used as the basis for identifying the regions of 'Low coverage' or 'High coverage'. The user chooses two parameter values in the wizard: (1) a 'Minimum length' and (2) a 'P-value threshold' value. The algorithm inspects the coverage in each of the positions in the read mapping and marks the ones with coverage in the lower or upper tails of the estimated Poisson distribution, using the provided p-value as cut-off. Regions with consecutive positions marked consistently as having low (respectively high) coverage, longer than the user specified 'Minimum length' value are called as 'Low coverage' (respectively 'High coverage') regions.

The coverage analysis tool produces an annotation track carrying the name of the original file followed by (COV). This file can be visualized as an annotation track or as a table depending on the users choice. The annotation table contains a row for each detected low or high coverage region, with information describing the location, the type and the p-value of the detected region. The p-value of a region is defined as the average of the p-values calculated for each of the positions in the region. The tool can also provide a report made of 2 tables. The first one, called References, lists per chromosome the number of reads, their length, and how many signatures of unexpectedly low or high coverage was found in the mapping. The second table lists on 2 rows low and high coverage signatures found, as well as how many reads were used to calculate these signatures.

25.3.1 Running the Coverage analysis tool

To run the Coverage analysis tool:

Toolbox | **Resequencing Analysis**  | **Coverage Analysis** 

This opens the dialog shown in figure 25.24.

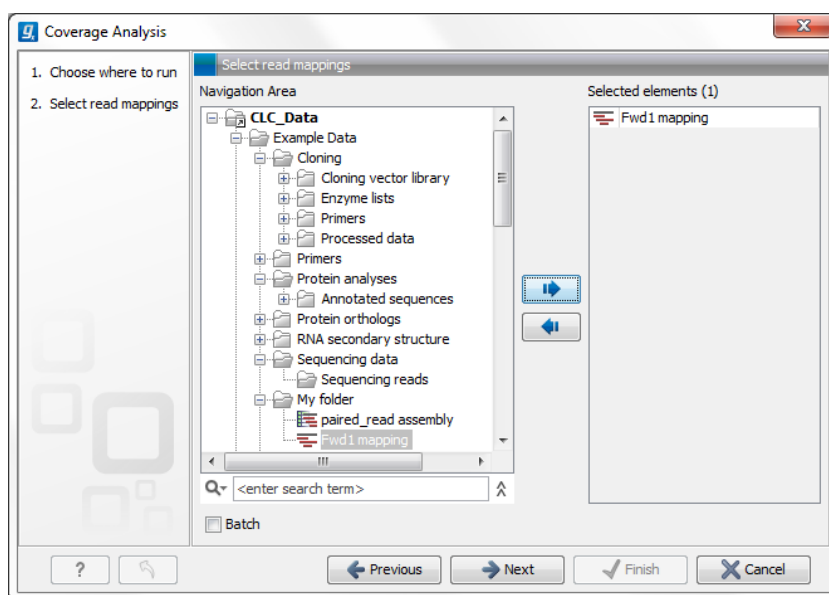

Figure 25.24: Select read mapping results.

Select a reads track or read mapping and click **Next**. This opens the dialog shown in figure 25.25.

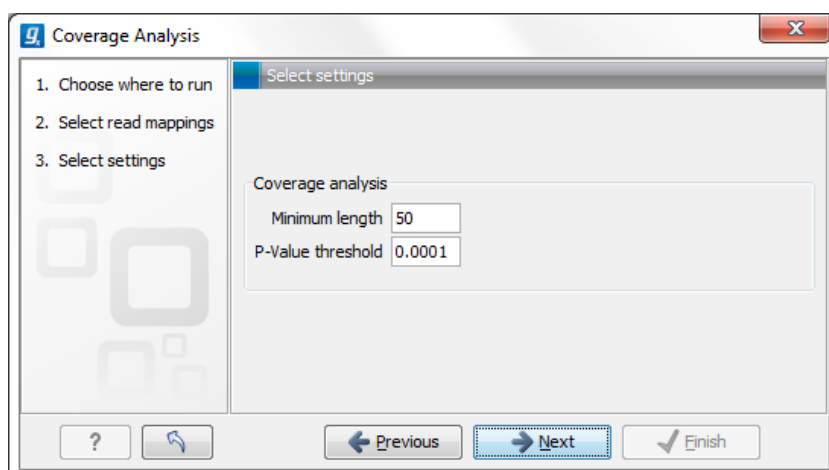

Figure 25.25: Specify the p-value cutoff.

Set the p-value and minimum length cutoff.

Click **Next** and specify the result handling (figure 25.26). Selecting the "Create regions" will generate the annotation track, while selecting the "Create report" will generate the report described above. Both options are pre-selected by default.

Open or save and click **Finish**.

An example of a track output of the Coverage analysis tool is shown in figure 25.27.

The Coverage Analysis table includes the following columns (figure 25.28):

Chromosome The name is taken from the reference sequence used for mapping

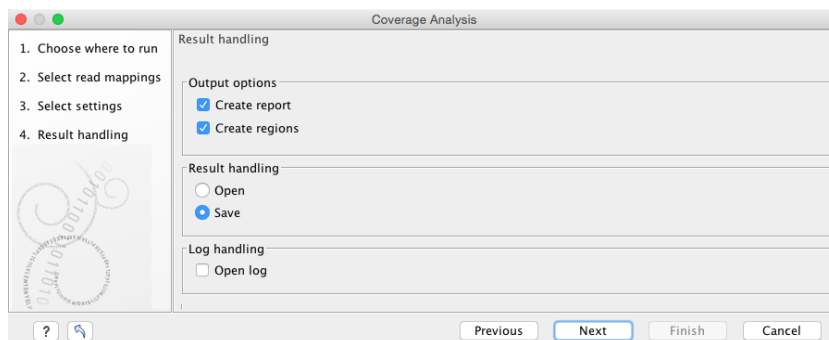

Figure 25.26: Specify the output.

Chromosome	Region	Name	p-value	Length
19	1..3000035	Low Coverage	2,55E-11	3000035
19	3005903..3006082	Low Coverage	2,29E-6	180
19	3006092..3006345	Low Coverage	8,18E-7	254
19	3006389..3006499	Low Coverage	7,80E-6	111
19	3012875..3012944	Low Coverage	9,02E-6	70
19	3013038..3013454	Low Coverage	2,64E-7	417
19	3013743..3014308	Low Coverage	5,35E-7	566
19	3018679..3018742	Low Coverage	3,14E-6	64
19	3019379..3019449	Low Coverage	9,93E-6	71
19	3022799..3023076	Low Coverage	1,76E-6	278
19	3023775..3023836	Low Coverage	3,39E-6	62
19	3023894..3023996	Low Coverage	2,78E-6	103
19	3024132..3024222	Low Coverage	1,66E-6	91
19	3025124..3025238	Low Coverage	9,75E-7	115
19	3025324..3025452	Low Coverage	1,45E-6	129
19	3025742..3025827	High Coverage	3,32E-6	86
19	3026047..3026159	Low Coverage	5,57E-6	113
19	3028029..3028112	High Coverage	7,44E-6	84
19	3028327..3028725	Low Coverage	1,02E-6	399

Figure 25.27: An example of a track output of the Coverage analysis tool.

Region The start and end position of this region on the reference sequence

Name The type of annotation: high or low coverage

P-Value The calculated significance p-value for this region

Length The length of the region

Chromosome	Region	Name	p-value	Length
18	51886795..51887354	High Coverage	1.39E-7	560
18	51887911..51888438	High Coverage	1.13E-7	528
18	51889026..51889406	High Coverage	2.31E-7	381
18	51891981..51892287	High Coverage	1.52E-7	307
18	51898705..51899113	High Coverage	1.87E-7	409
18	51900488..51900773	High Coverage	7.30E-8	286
18	51904439..51904741	High Coverage	1.66E-7	303
18	51933110..51933581	High Coverage	1.49E-7	472
18	52051811..52052012	High Coverage	9.22E-8	202
18	52258271..52258721	High Coverage	1.51E-7	451
18	52262019..52262459	High Coverage	2.91E-8	441
18	52264927..52265493	High Coverage	7.71E-8	567
18	52411949..52412210	High Coverage	5.05E-7	262
18	52544690..52545126	High Coverage	6.20E-8	437
18	52546468..52546831	High Coverage	1.52E-8	364
18	52551440..52551778	High Coverage	1.29E-7	339
18	52555072..52555458	High Coverage	9.10E-8	387
18	52556325..52556743	High Coverage	1.05E-7	419

Figure 25.28: The table output with detailed information on each region.

For the visual inspection and comparison to known gene/transcripts or other kind of annotations, all region are also annotated on the read mapping.

25.4 Variant Detectors - overview

CLC Genomics Workbench offers three tools for detecting variants.

- **Fixed Ploidy Variant Detection** (TFA) - described in detail in section 25.5
- **Low Frequency Variant Detection** (TFA) - described in detail in section 25.6
- **Basic Variant Detection** (TFA) - described in detail in section 25.7

They are designed for the analysis of different types of samples and they differ in their underlying assumptions about the data, and hence in their assessments of when there is enough information in the data for a variant to be called. An overview of these differences is given in figure 25.29.

Variant caller	Applications	Data	Variant detected	Comments	Examples of recommended applications
Fixed Ploidy	Germline variants	A sample for which the ploidy can be assumed known	Will detect variants whose representation in the reads is in accordance with the assumed ploidy	Will discard variants whose representation in the reads is likely due to sequencing errors or mapping artefacts	Germline variant calling
Low Frequency	Germline and somatic variants	A sample with unknown/mixed ploidy	Will detect variants whose representation in the reads is in accordance with the presence of a variant in a proportion of the reads	Will discard variants whose representation in the reads is likely due to sequencing errors	Any application where you are looking to detect low frequency (such as non-germline) variants
Basic	Any position that shows at least a specified number and frequency of nucleotide bases that differ from the reference base – irrespective of whether this may be explained by sequencing errors	Any	Will detect any variant observed in the reads	Will call a variant in any position that shows at least a specified number and frequency of nucleotide bases that differ from the reference base – irrespective of whether this may be explained by sequencing errors	exploratory read mapping applications - but not standard variant calling applications

Figure 25.29: An overview of the variant detection tools.

To run a variant detection tool, go to:

Toolbox | Resequencing Analysis (TFA) | Variant Detectors

If you double-click on one of the tools, a dialog is opened where you can select the **reads track** or read mapping to analyze.

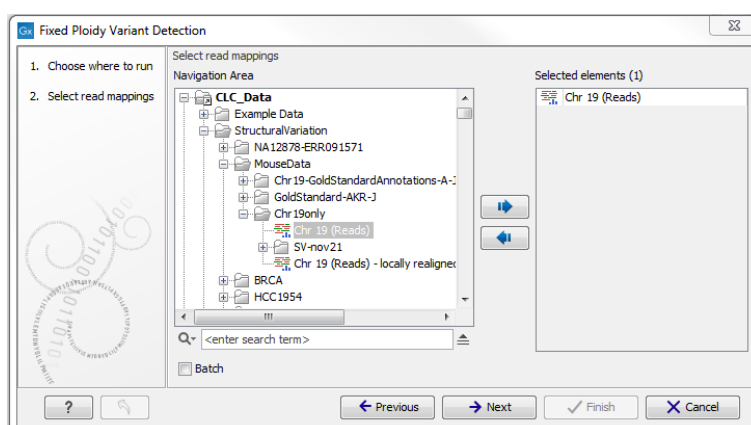

Figure 25.30: Select the read mapping that you want to analyze.

Click on the **Next** button when the reads track or mapping has been added to the right-hand side of the dialog.

The user is next asked to set the parameters that are specific for the variant detection tool. The three tools, their assumptions, and the tool-specific parameters are described later in their respective sections.

All variant detection tools will call:

- SNVs - single nucleotide variants
- MNVs - neighboring SNVs, where there is evidence they occur together
- small to medium-sized insertions and deletions - insertions and deletions fully represented within a single read
- replacements - neighboring SNVs and insertions or deletions

25.4.1 Differences in the variants called by the different tools

Because the tools differ in their underlying assumptions about the data, different variants may be called on the same data set using the same filter settings (see section 25.9). In general,

- the **Basic Variant Detection** tool calls the highest number of variants. It runs relatively quickly because it does not do any error-model estimation.
- the **Low Frequency Variant Detection** tool calls only a subset of the variants called by the Basic Variant Detection tool. The variants called by the Basic Variant Caller but **not** called by the Low Frequency Variant Detection tool usually originate from sequencing errors. The Low Frequency Variant caller is the slowest of the three variant callers as it estimates an error-model and does not just consider variants within a specified ploidy model.
- the **Fixed Ploidy Variant Detection** tool calls a subset of the variants called by the Low Frequency Variant Detection tool. The variants called by the Low Frequency Variant Caller but **not** called by the Fixed Ploidy Variant caller likely originate from mapping or sequencing errors.

The following examples show a Track list view of the variants detected by the three different variant detection tools for a particular data set with the same the filter settings. The top three variant tracks contain the results of the variant detection tools. The numbers of variants called are shown on the left side in brackets under the variant track names. The track 'basicV2' contains the results of the Basic Variant Detection tool, the track 'LowFreq' contains the results of the Low Frequency Variant Detection tool and the track 'FixedV2' contains the results of the Fixed Ploidy Variant detection tool. The other variant tracks display comparisons between results of the different tools. The particular comparisons is described in the name of each of these tracks.

Figure 25.31 highlights a variant reported by the Basic Variant Detection tool but not by the other variant caller tools. The information in the table view of the Basic Variant Detection results track ('basicV2') reveals that the variant is present at a low frequency (3 reads) in a high coverage position (209 reads), suggesting that is not a true variant but rather a sequencing error.

Figure 25.32 shows variant calls produced by the three variant callers with the same data and general filter settings. As expected, the Basic Variant Detection tool reports the most variants (884), the Fixed Ploidy reports the fewest (233), and the Low Frequency Variant Detection tool

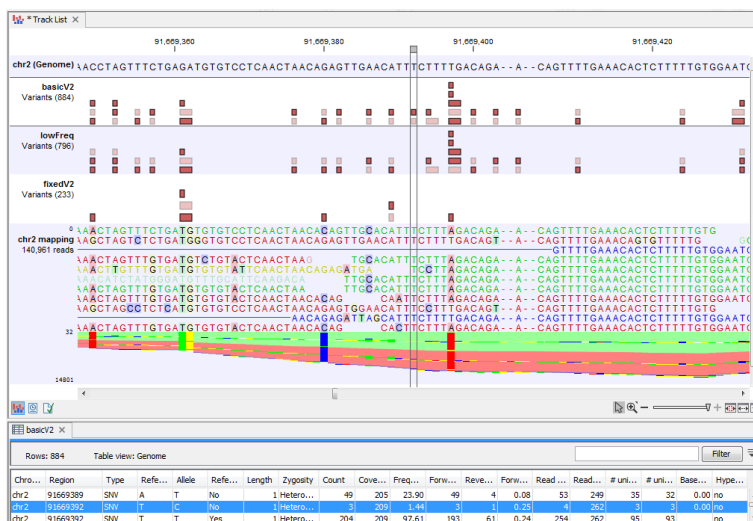

Figure 25.31: Case where a variant is detected only using the Basic Variant Detection tool.

detects a number between these two (796). But note that in the track named 'inLowFreqV2-notInBasicV2' that there are 9 variants reported by the Low Frequency Variant Detection tool that are not reported by the Basic Variant detection tool. It is because these variants are considered as several SNVs by the Low Frequency Variant Detection tool when they were part of a more complex MNV in the Basic Variant Detection results. In the case of the variant highlighted in figure 25.32, the Low Frequency Variant Detection calls for one variant in results track ('lowFreq'), while the Basic Variant Detection called a heterozygous 2 bp MNV in results track ('basicV2'). Here, the Low Frequency Variant Detection tool called only one of the two SNVs of that MNV. The second SNV of the MNV was not deemed to be supported by the evidence in the data when error modelling was carried out and so was not reported.

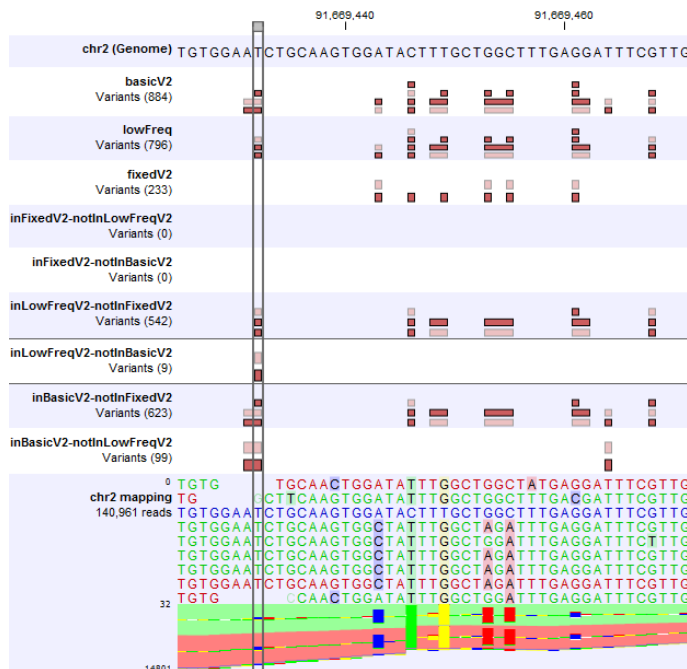

Figure 25.32: Case where variants can be detected as SNV by a tool and MNV by another.

Figure 25.33 shows a variant that is detected by both the Basic and the Low Frequency Variant Detection tools, but not by the Fixed Ploidy Variant Detection tool when a ploidy of 2 was specified. The information in the table view of the Low Frequency Variant Detection results track ('lowFreq') reveals that the highlighted variant is present in 29 reads in an area with coverage 204, a ratio inconsistent with what can be expected from a diploid sample, thus preventing the stringent Fixed Ploidy Variant Detection tool to call it as a variant. It is also unlikely that this variant was caused by sequencing error. The most likely explanation for the presence of this variant is that it originated from an error in the mapping of the reads. This happens if reads are mapped to a reference area that does not represent their true source, using for example an incomplete reference or one from a too distantly related organism.

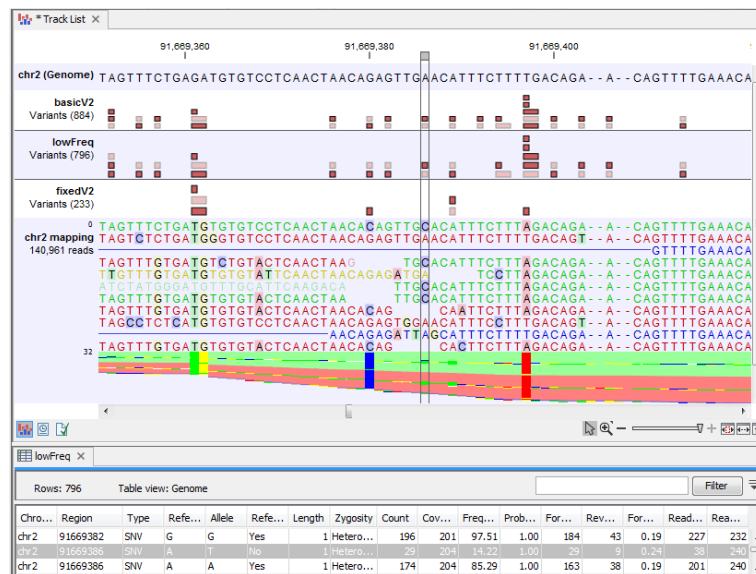

Figure 25.33: Case where a variant does not fit the ploidy assumption.

25.4.2 How the variant detection tools work

Each variant detection tool operates in a similar fashion, following successive and iterative steps while using common filters to call for variants. Before you start the tool, the wizard will take you through the different filters you can set to define which of the single polymorphisms detected should be called as a variant. The following sections describe the individual characteristics and the specific assumptions of the three variant detection tools. The filtering and output options common to the tools are described in detail in section 25.9 and section 25.10.

The steps of the Variant Detection tools are as follow:

1. The tool identify all possible variants from either the total input dataset or a subset of it, depending on how the following filters have been set:
 - **Reference masking** settings select the areas of the mapping that should be inspected for variants.
 - **Read filter** settings select for the reads that should be considered in the assessment.
 - **Count and coverage filters** selects for sites meeting coverage, frequency and absolute count requirements set for the analysis. Note that only the half of the cut-off values for these parameters are used in this first step, with the full cut-off values for count and coverage applied in a later phase. This ensures that larger variants existing at particular positions may be considered. Indeed, if the full filter values were applied when considering the single position variants in step 1, then it is possible that some SNVs would not be called, preventing in turn the detection of corresponding MNVs. By postponing filtering using the full value of the cutoffs specified, we minimize the risk of missing the detection of multiple position variants.
 - **Noise filters** decide of the inclusion of a read considering the quality and neighborhood composition of the area surrounding a potential variant.
2. In the case of the Fixed Ploidy and Low Frequency Variant Detection tools only, the tool estimates iteratively an error model while detecting potential variants.

For these variant detection tools, site-specific information is used in estimating error models, which are then used to distinguish true variants from likely sequencing errors. Potential single nucleotide variant will be only be kept if the model containing the variant is significantly better than the model without the variant. Full details for the Fixed Ploidy Variant Detection tool are given in section 25.5 and for the Low Frequency Variant Detection tool in section 25.6.
3. The tool checks each position for other features such as read direction, base qualities and so on using the cut-off values specified in the **Noise filters** (section 25.9).
4. The tool checks for complex variants by taking the single position variants identified in the steps above and checking if neighboring variants are present in *the same read*. If so, the tool 'joins' these SNVs into MNVs, longer insertions or deletions, or into replacements. Note that SNVs are joined only when they are present in the same read as it provides evidence that they occur together in the sample.
5. Finally the tool applies the full cut-off values supplied for the **Count and coverage filters** to the single and multiple position variants obtained during step 4.

25.5 Fixed Ploidy Variant Detection

The Fixed Ploidy Variant Detection tool relies on two models:

1. A model for the possible 'site-types' depends on the user-specified ploidy parameter: For a diploid organism there are two alleles and thus the site types are A/A, A/C, A/G, A/T, A/-, C/C, and so on until -/-.
2. A model for the sequencing errors that specifies the probabilities of having a certain base in the read but calling a different base. The error model is estimated from the data prior to calling the variants (see section 25.8).

The Fixed Ploidy algorithm will, given the estimated error model and the data observed in the site, calculate the probabilities of each of the site types. One of those site types is the site that is homozygous for the reference - that is, it stipulates that whatever differences are observed from the reference nucleotide in the reads is due to sequencing errors. The remaining site-types are those which stipulate that at least one of the alleles in the sample is different from the reference. The sum of the probabilities for these latter site types is the posterior probability that the sample contains at least one allele that differs from the reference at this site. We refer to this posterior probability as the 'variant probability'.

The Fixed Ploidy Variant Detection tool has two parameters: the 'Ploidy' and the 'Variant probability' parameters (figure 25.34):

- The 'ploidy' is the ploidy of the analyzed sample. The value that the user sets for this parameter determines the site types that are considered in the model. For more information about ploidy please see section 25.5.1.
- The 'Required variant probability' is the minimum probability value of the 'variant site' required for the variant to be called. Note that it is not the minimum value of the probability of the individual variant. For the Fixed Ploidy Variant detector, if a variant site - and not the variant itself - passes the variant probability threshold, then the variant with the highest probability at that site will be reported even if the probability of that particular variant might be less than the threshold. For example if the required variant probability is set to 0.9 then the individual probability of the variant called might be less than 0.9 as long as the probability of the entire variant site is greater than 0.9.

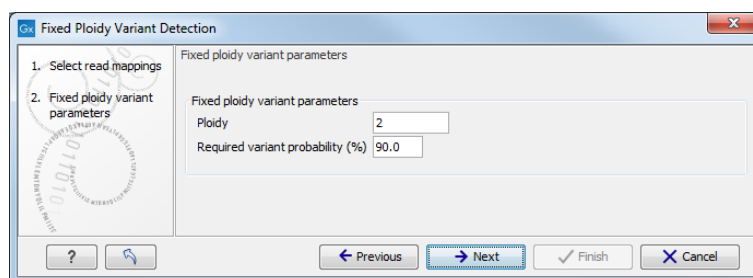

Figure 25.34: The Fixed Ploidy Variant Detection parameters.

As the Fixed Ploidy Variant Detection tool strongly depends on the model assumed for the ploidy, the user should carefully consider the validity of the ploidy assumption that he makes for his sample. The tool allows ploidy values up to and including 4 (tetraploids). For higher ploidy values

the number of possible site types is too large for estimation and computation to be feasible, and the user should use the Low Frequency or Basic Variant Detection Tool instead.

For a more in depth description of the Fixed Ploidy variant caller see Section [25.11](#).

25.5.1 Ploidy and sensitivity

The Fixed Ploidy Variant Detection tool has two parameters. The ploidy level you set defines the statistical model that will be used during the variant detection analysis and thereby also defines what will be reported. The number of alleles that variant may have depends on the value that has been chosen for the ploidy parameter. For example, if you chose a ploidy of 2, then the variant at a site could be a homozygote (two alleles the same in the sample, but different to the reference), or a heterozygote (two alleles different than each other in the sample, with at least one of them different from the reference). If you had chosen a ploidy of three, then the variant at a site could be a homozygote (three alleles the same in the sample, but different to the reference), or a heterozygote (three alleles different than each other in the sample, with at least one of them different from the reference).

The variant probability parameter defines how good the evidence has to be at a particular site for the tool to report a variant at that location. If the *site* passes this threshold, then the *variant* with the highest probability at that site will be reported.

Sensitivity of the tool can be altered by changing these parameters: to increase sensitivity, you could decrease the variant probability setting - more sites are being reported - or increase the ploidy - adding extra allele types.

For example, a sample with a ploidy of 2 has many C and a few G at a particular location where the reference is a T. There is high enough evidence that the actual position is different than the reference, so the variant with the highest probability at this location will be reported. In the diploid model, all the possibilities will have been tested (e.g. A|A, A|C....C|C, C|G. C|T....and so on). In this example, C|C had the highest probability, and as long as the relative prevalence of Gs is low compared to Cs - that is, the probability of C|C stays higher than C|G - C|C will be reported. But in a case where the sample has a ploidy of 3, the model will test all the triploid possibilities (e.g. A|A|A, A|A|C, A|A|G.....C|C|A, C|C|C, C|C|G.... and so on). For the same site, if the evidence in the reads results in the variant C|C|G having a higher probability than C|C|C, then it would be the variant reported. This shows that by increasing ploidy we have increased sensitivity of the tool, reporting a variant that represents the reads with G as well as the ones reporting a C at a particular position.

25.6 Low Frequency Variant Detection

As the Fixed Ploidy Variant Detection tool, the Low Frequency Variant Detection tool relies on

1. A statistical model for the analyzed sample and
2. A model for the sequencing errors.

A statistical test is performed at each site to determine if the nucleotides observed in the reads at that site could be due simply to sequencing errors, or if they are significantly better explained

by there being one (or more) alleles. If the latter is the case, a variant corresponding to the significant allele will be called with an estimated frequency.

The Low Frequency Variant Detection tool has one parameter (figure 25.35):

- **Required Significance:** this parameter determines the cut-off value for the statistical test for the variant not being due to sequencing errors. Only variants that are at least this significant will be called. The lower you set this cut-off, the fewer variants will be called.

The Low Frequency Variant Detection tool is suitable for analysis of samples of mixed tissue types (such as cancer samples) in which low frequent variants are likely to be present, as well as for samples for which the ploidy is unknown or not well defined. The tool also calls more abundant variants, and can be used for analysis of samples with ploidy larger than four. Note that, as the tool looks for all variants, abundant as well as low frequency ones, analysis will generally be slower than those of the other variant detection tools. In particular it will be very slow - possibly prohibitively so - for samples with extremely high coverage, or a very large number of variants (as in cases where the sample differs considerably from the reference).

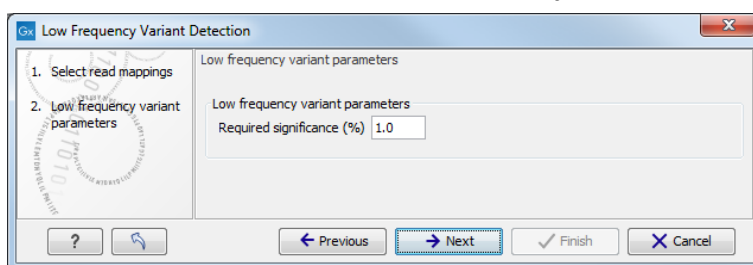

Figure 25.35: *The Low Frequency Variant Detection parameters.*

For a more in depth description of the Low Frequency variant caller see section 25.11.

25.7 Basic Variant Detection

The Basic Variant Detection tool does not rely on any assumptions on the data, and does not estimate any error model. It can be used on any type of sample. It will call a variant if it satisfies the requirements that you specify when you set the filters (see section 25.9). The tool has a single parameter (figure 25.36) that is specific to this tool: the user is asked to specify the 'ploidy' of the sample that is being analyzed. The value of this parameter does not have an impact on which variants are called - it will merely determine the contents of the 'hyper-allelic' column that is added to the variant track table: variants that occur in positions with more variants than expected given the specified ploidy, will have 'Yes' in this column, other variants will have 'No' (see section 25.10 for a description of the outputs).

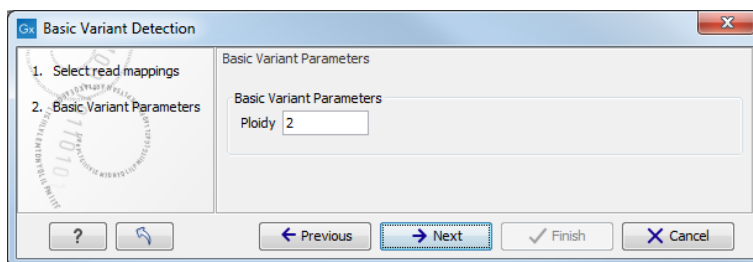

Figure 25.36: *The Basic Variant Detection parameters.*

25.8 Variant Detectors - error model estimation

The Fixed Ploidy and Low Frequency Variant Detection tools both rely on statistical models for the sequencing error rates. An error model is assumed and estimated for each quality score. Typically low quality read nucleotides will have a higher error rate than high quality nucleotides. In the error models, different types of errors have their own parameter, so if A's for example more often tend to result in erroneous G's than other nucleotides, that is also recognized by the error models. The parameters are all estimated from the data set being analyzed, so will adapt to the sequencing technology used and the characteristics of the particular sequencing runs. Information on the estimated error rates can be found in the Reports (see section 25.10 and figure 25.37).

1.5 Estimated frequencies of actual to called bases (quality scores: 20-29)

Called (across): Actual (below):	A	C	G	T	N	-
A	99.828	0.015	0.086	0.023	0.044	0.005
C	0.050	99.854	0.034	0.043	0.017	0.002
G	0.043	0.011	99.897	0.029	0.017	0.003
T	0.026	0.050	0.032	99.868	0.021	0.003
-	0.000	0.000	0.000	0.000	0.000	100.000

Number of sequenced bases with quality scores 20-29: 382,854,867

1.6 Estimated frequencies of actual to called bases (quality scores: 30-39)

Called (across): Actual (below):	A	C	G	T	N	-
A	99.979	0.001	0.008	0.003	0.008	0.001
C	0.010	99.976	0.002	0.008	0.002	0.001
G	0.008	0.001	99.974	0.012	0.004	0.001
T	0.003	0.008	0.002	99.983	0.003	0.001
-	0.000	0.000	0.000	0.000	0.000	100.000

Number of sequenced bases with quality scores 30-39: 7,400,088,878

Figure 25.37: Example of estimated error rates estimated from a whole exome sequencing Illumina data set.

The figure shows average estimated error rates across bases in the given quality score intervals (20-29 and 30-39, respectively). As expected, the estimated error rates (that is, the off-diagonal elements in the matrices in the figure) are higher for bases with lower quality scores. Note also that although the matrices in the figure show error rates of bases within *ranges* of quality scores, a separate matrix is estimated for each quality score in the error model estimation.

25.9 Variant Detectors - filters

The variant detectors offer a number of filters for which the user will set values in two wizard steps, the 'General filters' and the 'Noise filters'. Note that the tools add for most filters the values calculated and the bases filtered on as annotations to the variants (see section 25.10). This means that the filtering information is available in the variant track and that the user can choose to perform the filtering in a post-processing step from the variant track table rather than applying the filtering during the variant calling detection step.

The filters are described below.

25.9.1 General filters

The General filters relate to the regions and reads in the read mappings that should be considered, and the amount of evidence the user wants to require for a variant to be called (figure 25.38):

General filters

Reference masking

Ignore positions with coverage above 100000

Restrict calling to target regions

Read filters

Ignore broken pairs

Ignore non-specific matches Reads

Minimum read length 20

Coverage and count filters

Minimum coverage 10

Minimum count 2

Minimum frequency (%) 20.0

← Previous → Next ✓ Finish ✕ Cancel

Figure 25.38: *General filters*. The values shown are those that are default for *Fixed Ploidy Variant detection*.

Note on the use of the Low Frequency Variant Detection tool with Whole Genome Sequencing data: The default settings for the Low Frequency Variant caller are optimized for targeted resequencing protocols, and NOT whole genome sequencing (e.g. cancer gene panels) where it is not uncommon to have modest coverage for most part of the mapping, and abnormal areas (typically repeats around the centromeres) with very high coverage. Looking for low frequency variants in high coverage areas will exhaust the machine memory because there will be many low frequency variants due to some reads originating from near identical repeat sequences or simple sequencing errors. In order to run the tool on WGS data the parameter **Ignore positions with coverage above** should be adjusted to a lower number (typically 1000).

Reference masking

The 'Reference masking' filters allow the user to only perform variant calling (including error model estimation) in specific regions. In addition to selecting an annotation track, there are two parameters to specify:

- **Ignore positions with coverage above:** All positions with coverage above this value will be ignored when inspecting the read mapping for variants. The option is highly useful in cases where you have a read mapping which has areas of extremely high coverage as are areas around centromeres in whole genome sequencing applications for example.
- **Restrict calling to target regions:** Only positions in the regions specified will be inspected for variants.

Read filters

The Read filters determine which reads (or regions) should be considered when calling the variants.

- **Ignore broken pairs:** When ticked, reads from broken pairs are ignored. Broken pairs may arise for a number of reasons, one being erroneous mapping of the reads. In general,

variants based on broken pair reads are likely to be less reliable, so ignoring them may reduce the number of spurious variants called. However, broken pairs may also arise for biological reasons (e.g. due to structural variants) and if they are ignored some true variants may go undetected. Please note that ignored broken pair reads will not be considered for any non-specific match filters.

- **Non-specific match filter:** Non-specific matches are likely to come from repeat region whose exact mapping location is uncertain. In general, variants based on non-specific matches are likely to be less reliable. However, as there are regions in the genome that are entirely perfect repeats, ignoring non-specific matches may have the effect that true variants go undetected in these regions.

There are three options for specifying to which 'extent' the non-specific matches should be ignored:

- 'No': they are not ignored.
- 'Reads': they are ignored.
- 'Region': when this option is chosen no variants are called in regions covered by at least one non-specific match. In this case, the minimum length of reads that are allowed to trigger this effect has to be stated, as really short reads will usually be non-specific even if they do not stem from repeat regions.

Coverage and count filters

These filters specify absolute requirements for the variants to be called. Note that suitable values for these filters are highly dependent on the coverage in the sample being analyzed:

- **Minimum coverage:** Only variants in regions covered by at least this many reads are called.
- **Minimum count:** Only variants that are present in at least this many reads are called.
- **Minimum frequency:** Only variants that are present at least at the specified frequency (calculated as 'count'/'coverage') are called.

These values are calculated for each of the detected candidate variants. If the candidate variant meets the specified requirements, it is called. Note that when the values are calculated, only the 'countable reads' - the reads chosen by the user to NOT be ignored - are considered. For example, if the user had specified to ignore reads from broken pairs, they will not be countable. This is also the case for non-specific reads, and for reads with bases at the variant position that does not fulfill the base quality requirements specified by the 'Base Quality Filter' (see the section on 'Noise filters' below). Also note that overlapping paired reads only count as one read since they only represent one fragment.

25.9.2 Noise filters

The 'Noise filters' examine each candidate variant at a more detailed level and filter out those that are likely the result of systematic errors and/or biases, such as those coming from samples preparation steps or sequencing protocol (figure 25.39). These filters should be used with care as there is always the risk of not calling a real variant that has the characteristics of a systematically induced one.

Figure 25.39: Noise filters.

Quality filters

- **Base quality filter:** The base quality filter can be used to ignore the reads whose nucleotide at the potential variant position is of dubious quality. This is assessed by considering the quality of the nucleotides in the region around the nucleotide position. There are three parameters to determine the base quality filter:
 - **Neighborhood radius:** This parameter determines the region size. For example if a neighborhood radius of five is used, a nucleotide will be evaluated based on the nucleotides that are 5 positions upstream and 5 positions downstream of the examined site, for a total of 11 nucleotides. Note that, near the end of the reads, eleven nucleotides will still be considered by offsetting the region relative to the nucleotide in question.
 - **Minimum central quality:** Reads whose central base has a quality below the specified value will be ignored. This parameter does not apply to deletions since there is no 'central base' in these cases.
 - **Minimum neighborhood quality:** Reads for which the minimum quality of the bases is below the specified value will be ignored.

Figure 25.40 gives an example of a variant called when the base quality filter is NOT applied, and not called when it is. When switching on the 'Show quality scores' option in the side panel of the reads it becomes visible that the reads that carry the potential 'G' variant tend to have poor quality. Note that the error in the example shown is a 'typical' Illumina error: the reference has a 'T' that is surrounded by stretches of 'G', the 'G' signals 'drowning' the signal of the 'T'. As all reads that have a base with quality less than 20 in this potential variant position are ignored when the 'Base quality filter' is turned on, no variant is called, most likely because it now does not meet the requirements of either the 'Minimum coverage', 'Minimum count' or 'Minimum frequency' filters.

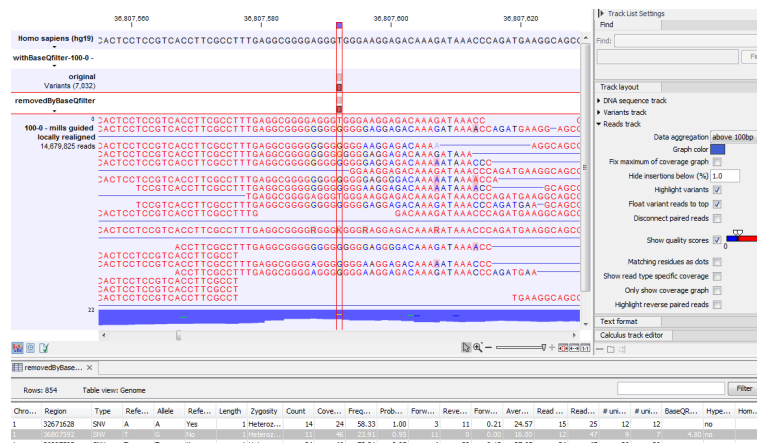

Figure 25.40: Example of a variant called when the base quality filter is NOT applied, and not called when it is.

Direction and position filters

Many sequencing protocols are prone to various types of amplification induced biases and errors. The 'Read direction' and 'Read position' filters are aimed at providing means for weeding out variants that are likely to originate from such biases.

- Read direction filter:** The read direction filter removes variants that are almost exclusively present in either forward or reverse reads. For many sequencing protocols such variants are most likely to be the result of amplification induced errors. Note, however, that the filter is **NOT suitable for amplicon data**, as for this you will not expect coverage of both forward and reverse reads. The filter has a single parameter:
 - Direction frequency:** Variants that are not supported by at least this frequency of reads from each direction are removed.
- Relative read direction filter:** The relative read direction filter attempts to do the same thing as the 'Read direction filter', but does this in a statistical, rather than absolute, sense: it tests whether the distribution among forward and reverse reads of the variant carrying reads is different from that of the total set of reads covering the site. The statistical, rather than absolute, approach makes the filter less stringent. The filter has one parameter:
 - Significance:** Variants whose read direction distribution is significantly different from the expected with a test at this level, are removed. The lower you set the significance cut-off, the fewer variants will be filtered out.
- Read position filter:** The read position filter is a filter that attempts to remove systematic errors in a similar fashion as the 'Read direction filter', *but* that is also **suitable for hybridization-based data**. It removes variants that are located differently in the reads carrying it than would be expected given the general location of the reads covering the variant site. This is done by categorizing each sequenced nucleotide (or gap) according to the mapping direction of the read and also where in the read the nucleotide is found; each read is divided in five parts along its length and the part number of the nucleotide is recorded. This gives a total of ten categories for each sequenced nucleotide and a given site will have a distribution between these ten categories for the reads covering the site. If a variant is present in the site, you would expect the variant nucleotides to follow the

same distribution. The read position filter carries out a test for whether the read position distribution of the variant carrying reads is different from that of the total set of reads covering the site. The filter has one parameter:

- **Significance:** Variants whose read position distribution is significantly different from the expected with a test at this level, are removed. The lower you set the significance cut-off, the fewer variants will be filtered out.

Figure 25.41 shows an example of a variant that is removed by the 'Read direction' filter. To see the direction of the reads, you must adjust the viewer settings in the 'Reads track' side panel to 'Disconnect paired reads'. Note that variant calling was done ignoring non-specific matches and broken pair reads, so only the 16 intact forward paired reads (the green reads) are considered. In this example there was no intact reverse reads.

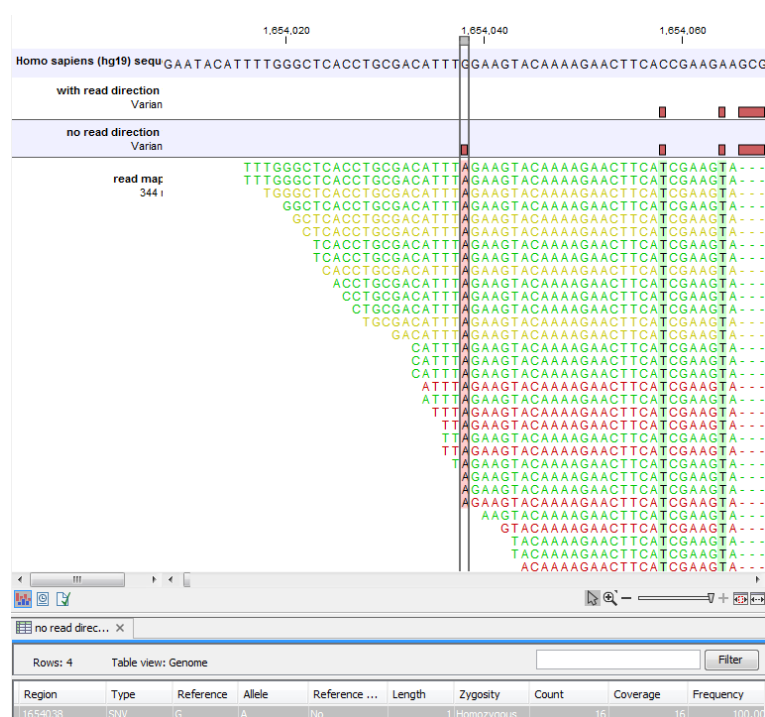

Figure 25.41: Example of a variant that is removed by the 'Read direction' filter.

Figure 25.42 shows an example of a variant that is removed by the 'Read position' filter, but not by the 'Read direction' filter. This variant is only seen in a set of reads having a similar start position, while reads that start in a different location do not contain this variant (e.g., none of the reads that start after position 186,641,600 carry the variant). This could indicate the incorporation of an incorrect base during the library preparation process rather than a true biological variant. The purpose of the 'Read position' filter is to reduce the presence of these types of variants. As with all noise filters, the more stringent the setting, the more likely you are to remove false positives and enrich your result for true positive variant calls but comes with the risk of filtering out true positives as well.

Understanding the type of false positive this filter is intended to remove will help you to determine what makes sense for your data set. For example, if your sequencing data did not include a PCR step or hybrid capture step, you may wish to use more lax settings for this filter (or not use it at all).

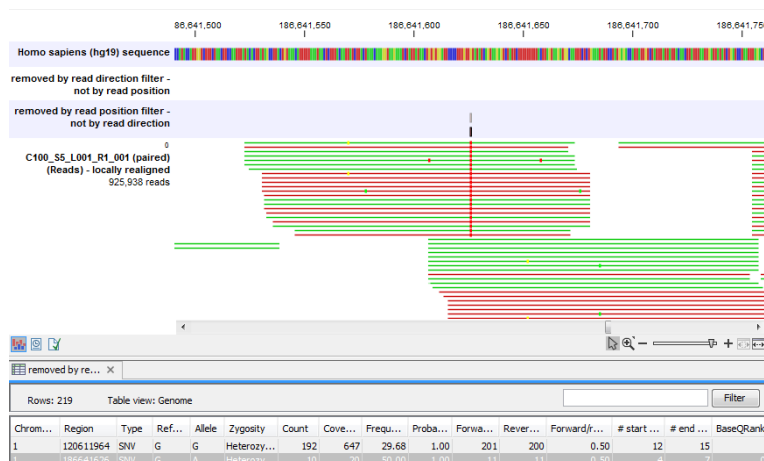

Figure 25.42: A variant that is filtered out by the Read position filter but not by the Read direction filter.

Technology specific filters

- Remove pyro-error variants:** This filter can be used to remove insertions and deletions in the reads that are likely to be due to pyro-like errors in homopolymer regions. There are two types of such errors: They may occur either at (1) the immediate ends of homopolymer regions or (2) as an 'overspill' a few nucleotides downstream of a homopolymer region. In case (1) the exact numbers of the same number of nucleotide is uncertain and a sequence like "AAAAAAAA" is sometimes reported as "AAAAAAAAA". In case (2) a sequence like "CGAAAAAGTCG" may sometimes get an 'overspill' insertion of an A between the T and C so that the reported sequence is C "CGAAAAAGTACG". Note that the removal is done in the reads as a very first step, before calling the initial 1 bp variants.

There are two parameters that must be specified for this filter:

- In homopolymer regions with minimum length:** Only insertion or deletion variants in homopolymer regions of at least this length will be removed.
- With frequency below:** Only insertion or deletion variants whose frequency (ignoring all non-reference and non-homopolymer variant reads) is lower than this threshold will be removed.

Note that the higher you set the **With frequency below** parameter, the more variants will be removed. Figure 25.43 shows an example of a variant that is called when the pyro-error filter with minimum length setting 3 and frequency setting 0.5 is used, but that is filtered when the frequency setting is increased to 0.8. The variant has a frequency of 55.71.

In addition to the example above, a simple example is provided below in figure 25.44 to illustrate the difference between variant frequency and pyro-variant removal frequency (where non-reference and non-homopolymer variant reads are ignored).

The read with the T variant is not counted when calculating the frequency for the homopolymer deletion, because we only want to estimate how often a homopolymer variant appears for a given allele, and the T read is not from the same allele as the A and gap reads.

For the deletion, the variant frequency will be 50 percent, if it is reported. This is because it appears in 3 of 6 reads.

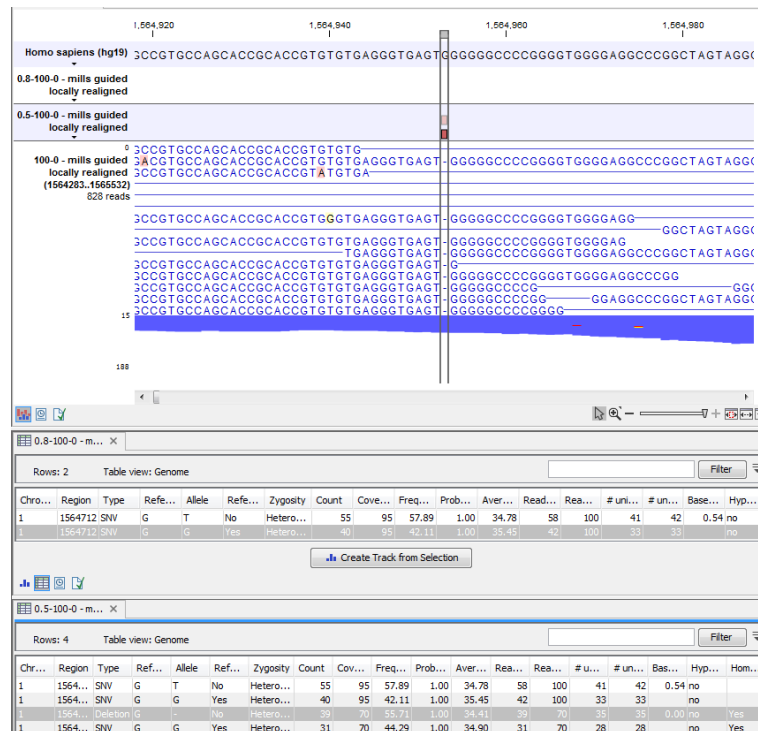

Figure 25.43: An example of a variant that is filtered out when the pyro-error filter is applied with settings 3 and 0.8, but not with settings 3 and 0.5.

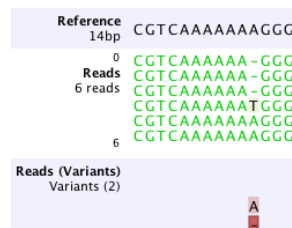

Figure 25.44: An example of a simple read mapping with 6 mapped reads. Three of them indicate a deletion, two match the reference, and one read is an A to T SNP

However, the pyro-variant removal frequency is 0.6, because it appears in 3 of 5 reads that come from the same allele. Thus the deletion will only be removed by the pyro-filter if the **With frequency below** parameter is above 0.6 and the **In homopolymer regions with minimum length** parameter is less than 7.

25.10 Variant Detectors - the outputs

The Variant Detection Tools have the following outputs: a variant track, an annotated variant table and a report (figure 25.45). The report contains information on the estimated error model and, as only the Fixed ploidy and the Low Frequency variant callers uses an error model, the report is only available for those, and not for the Basic Variant caller. The outputs are described below.

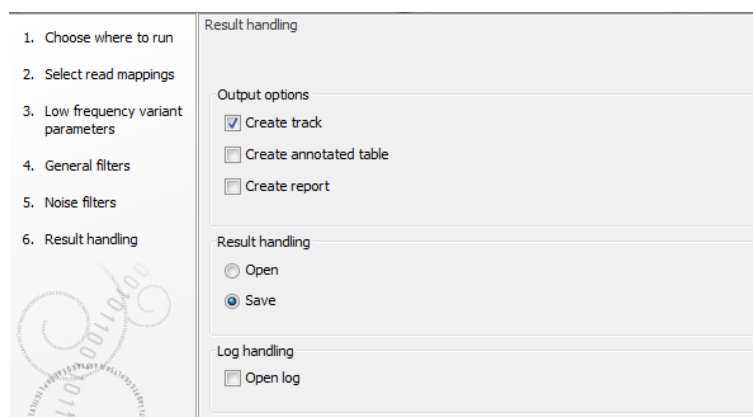

Figure 25.45: Output options.

25.10.1 The variant track output

The variant track contains information on each of the variants called, including reference alleles. When opened in the table view there is a number of columns for each of the variants (see figure 25.46).

Ch...	Region	Type	Refs...	Allele	Refer...	Length	Zygoty...	Count	Coverage	Frequ...	Proba...	Forwa...	Reve...	Forward/fr...	Avera...	Read C...	Read cov...	# uniq...	# uniq...	Base...	Hy...	...
1	1564953	Dele...	G	-	No	1	Heterozyg...	39	70	55.71	1.00	34	5	0.13	34.41	39	70	35	35	0.00	no	Yes
1	1564953	SNV	G	G	Yes	1	Heterozyg...	31	70	44.29	1.00	24	7	0.23	34.90	31	70	28	28	0.00	no	Yes
1	1920434^1...	Inse...	-	A	No	1	Heterozyg...	5	24	20.83	0.90	2	4	0.33	32.00	6	27	5	5	0.00	no	Yes
1	1920434^1...	Inse...	-	-	Yes	0	Heterozyg...	18	24	75.00	0.90	13	6	0.32	35.06	20	27	17	16	no	no	Yes
1	3395974..3...	MNV	CC	CC	Yes	2	Heterozyg...	23	42	54.76	1.00	20	6	0.23	35.96	26	47	36	39	no	no	Yes
1	3395974..3...	Dele...	CC	-	No	2	Heterozyg...	19	42	45.24	1.00	13	8	0.38	31.58	21	47	36	39	2.86	no	Yes

Figure 25.46: A variant track shown in the table view.

The contents of these are:

Chromosome The name of the reference sequence on which the variant is located.

Region The region on the reference sequence at which the variant is located. The region may be either a 'single position', a 'region' or a 'between position region'.

Type The type of variant. This can either be SNV (single-nucleotide variant), MNV (multi-nucleotide variant), insertion, deletion, or replacement. Learn more in section 25.12.3.

Reference The reference sequence at the position of the variant.

Allele The allele sequence of the variant.

Reference allele Describes whether the variant is identical to the reference. This will be the case for one of the alleles for most, but not all, detected heterozygous variants (e.g. the variant caller might detect two variants, A and G, at a given position in which the reference is 'A'. In this case the variant corresponding to allele 'A' will have 'Yes' in the 'reference allele' column entry, and the variant corresponding to allele 'G' would have 'No'. Had the variant caller called the two variants 'C' and 'G' at the position, both would have had 'No' in the 'Reference allele' column).

Length The length of the variant. The length is 1 for SNVs, and for MNVs it is the number of allele or reference bases (which will always be the same). For deletions, it is the length of the deleted sequence, and for insertions it is the length of the inserted sequence. For replacements, both the length of the replaced reference sequence and the length of the inserted sequence are considered, and the longest of those two is reported.

Zygoty The zygoty of the variant called, as determined by the variant caller. This will be either 'Homozygous', where there is only one variant called at that position or 'Heterozygous' where more than one variant was called at that position.

Count The number of 'countable' fragments supporting the allele. The 'countable' fragments are those that are used by the variant caller when calling the variant. Which fragments are 'countable' depends on the user settings when the variant calling is performed - if e.g. the user has chosen 'Ignore broken pairs', reads belonging to broken pairs are not 'countable'. Note that, although overlapping paired reads have two reads in their overlap region, they only represent one fragment, and are counted only as one. (Please see the column 'Read count' below for a column that reports the value for 'reads' rather than for 'fragments').

Coverage The fragment coverage at this position. Only 'countable' fragments are considered (see under 'Count' above for an explanation of 'countable' fragments). Note that, although overlapping paired reads have two reads in their overlap region, they only represent one fragment, and overlapping paired reads contribute only 1 to the coverage. (Please see the column 'Read coverage' below for a column that reports the value for 'reads' rather than for 'fragments'). Also see overlapping pairs in section 25.13 for how overlapping paired reads are treated.)

Frequency 'Count' divided by 'Coverage'.

Probability The contents of the Probability column (for Low frequency and Fixed Ploidy variant callers only) depend on the variant caller that produced and the type of variant:

- In the Fixed Ploidy Variant Detection Tool, the probability in the resulting variant track's 'Probability' column is NOT the probability referred to in the wizard. The probability referred to in the wizard is the required minimum (posterior) probability that the site is NOT homozygous for the reference. The probability in the variant track 'Probability' column is the posterior probability of the particular site-type called. The fixed ploidy tool calculates the probability of the different possible configurations at each site. So using this tool, for single site variants the probability column just contains this quantity (for variants that span multiple positions see below).
- The Low frequency Variant Detection tool makes statistical tests for the various possible explanations for each site. This means that the probability for the called variant must be estimated separately since it is not part of the actual variant calling. This is done by assigning prior probabilities to the various explanations for a site in a way that makes the probability for two explanations equal in exactly the situation where the statistical test shifts from preferring one explanation to the other. For a given single site variant, the probability is then calculated as the sum of probabilities for all the explanations containing that variant. So if a G variant is called, the reported probability is the sum of probabilities for these configurations: G, A/G, C/G, G/T, A/C/G, A/G/T, C/G/T, and A/C/G/T (and also all the configurations containing deletions together with G).

For multi position variants, an estimate is made of the probability of observing the same read data if the variant did not exist and all observations of the variant were due to sequencing errors. This is possible since a sequencing error model is found for both the fixed ploidy and rare variant tools. The probability column contains one minus this estimated probability. If this value is less than 50%, the variant might as well just be the result of sequencing errors and it is not reported at all.

Forward read count The number of 'countable' forward reads supporting the allele (see under 'Count' above for an explanation of 'countable' reads).

Reverse read count The number of 'countable' reverse reads supporting the allele (see under 'Count' above for an explanation of 'countable' reads).

Forward/reverse balance The minimum of the fraction of 'countable' forward reads and 'countable' reverse reads carrying the variant among all 'countable' reads carrying the variant (see under 'Count' above for an explanation of 'countable' reads).¹

Average quality The average base quality score of the bases supporting a variant. In the case of a deletion, the quality score is taken from the average quality of the two bases neighboring the deleted one, and the lowest is reported. Similarly for insertions, the quality in reads where the insertion is absent is taken from the minimum average of the two bases on either side of the position. It can be possible in rare cases, that the quality score reported in this column for a deletion or insertion is below the threshold set for 'Minimum central quality', because this parameter is not applied to any quality value calculated from positions *outside* of the central variant. To remove low quality variants from the output, use the **Filter Marginal Variant Calls** tool (see section 25.14.6). If there are no values in this column, it is probably because the sequencing data was imported without quality scores (learn more about importing quality scores from different sequencing platforms in section 6.3).

Read count The number of 'countable' reads supporting the allele. Only 'countable' reads are considered (see under 'Count' above for an explanation of 'countable' reads). Note that each read in an overlapping pair contribute 1. To view the reads in pairs in a reads track as single reads, check the 'Disconnect paired reads' option in the side-panel of the reads track. (Please see the column 'Count' above for a column that reports the value for 'fragments' rather than for 'reads').

Read coverage The read coverage at this position. Only 'countable' reads are considered (see under 'Count' above for an explanation of 'countable' reads). Note that each read in an overlapping pair contribute 1. To view the reads in pairs in a reads track as single reads, check the 'Disconnect paired reads' option in the side-panel of the reads track. (Please see the column 'Coverage' above for a column that reports the value for 'fragments' rather than for 'reads').

Unique start positions The number of unique start positions for 'countable' fragments that support the variant. This value can be important to look at in cases with low coverage. If all reads supporting the variant have the same start position, you could suspect that it is a result of an amplification error.

Unique end positions The number of unique end positions for 'countable' fragments that support the variant. This value can be important to look at in cases with low coverage. If all reads supporting the variant have the same end position, you could suspect that it is a result of an amplification error.

¹Some systematic sequencing errors can be triggered by a certain combination of bases. This means that sequencing one strand may lead to sequencing errors that are not seen when sequencing the other strand (see [Nguyen et al., 2011] for a recent study with Illumina data). In order to evaluate whether the distribution of forward and reverse reads is approximately random, this value is calculated as the minimum of the number of forward reads divided by the total number of reads and the number of reverse reads divided by the total number of reads supporting the variant. An equal distribution of forward and reverse reads for a given allele would give a value of 0.5.)

BaseQRankSum The BaseQRankSum column contains an evaluation of the quality scores in the reads that have a called variant compared with the quality scores of the reference allele. Reference alleles and variants for which no corresponding reference allele is called do not have a BaseQRankSum value. The score is a Z score, so a value of 2.0 means that the observed qualities for the variant are two standard deviations below the qualities for the reference allele. The scoring is performed using a Mann-Whitney U for comparing the two sets of quality scores from the reference allele and the variant.

Read position test probability The test probability for the test of whether the distribution of the read positions variant in the variant carrying reads is different from that of all the reads covering the variant position.

Read direction test probability The test probability for the test of whether the distribution among forward and reverse reads of the variant carrying reads is different from that of all the reads covering the variant position.

Hyper-allelic Basic and Fixed Ploidy Variant detectors only: Contains "yes", if the site contains more variants than the user-specified ploidy predicts, "no" if not.

Genotype Fixed Ploidy only: Contains the most probable genotype for the site.

Homopolymer The column contains "Yes" if the variant is likely to be a homopolymer error and "No" if not. This is assessed by inspecting all variants in homopolymeric regions longer than 2. A variant will get the mark "yes" if it is a homopolymeric length variation of the reference allele, or a length variation of another variant that is a homopolymeric variation of the reference allele. When several overlapping homopolymeric variants are identified, all except the most frequent are marked as being homopolymer. However, if one of the overlapping, homopolymeric variants is the reference allele, then all of them are marked as homopolymer.

QUAL This value is necessary for certain downstream analyses of the data after export in vcf format. It is calculated as

$$-10 \log_{10}(1 - p) \quad (25.1)$$

p being the probability that a particular variant exists in the sample (see above for the definition of probability). QUAL is capped at 200 for p=1.

25.10.2 The annotated table output

The 'Annotated table' contains only non-reference alleles. For a detailed description of the output, please see section [25.12.2](#).

25.10.3 The report

In addition to the estimated error rates of the different types of errors shown in figure [25.37](#), the report contains information on the total error rates for each quality score as well as a distribution of the qualities of the individual bases in the reads in the read mapping, at the sites that were examined for variants (see figure [25.47](#)).

1.1 Error rates for quality categories

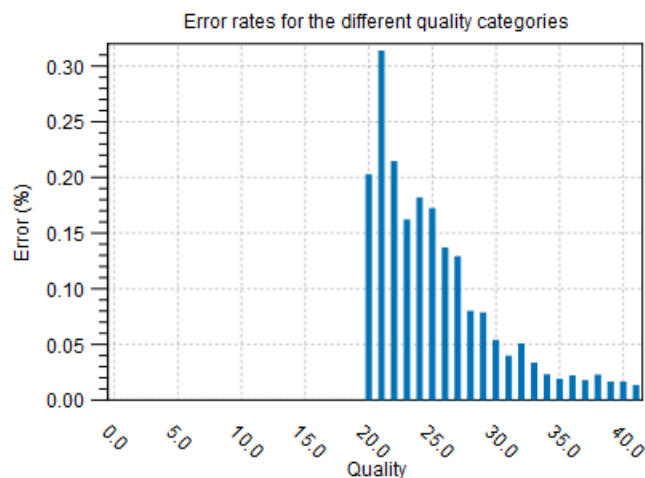

1.2 Qualities of examined sites

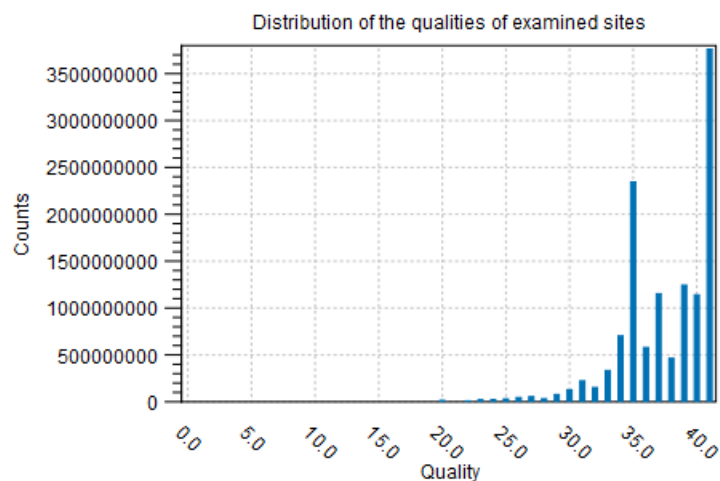

Figure 25.47: Part of the contents of the report on the variant calling.

25.11 The Fixed Ploidy and Low Frequency variant callers: detailed descriptions

This section provides a detailed description of the models, methods and estimation procedures behind the Fixed Ploidy and Low frequency variant callers. For less detailed descriptions please see sections Section 25.5 and Section 25.6.

25.11.1 The Fixed Ploidy Variant Caller: Models and methods

This section describes the model, method and estimation procedure behind the Fixed Ploidy Variant Caller. The Fixed Ploidy Variant Caller is designed for detecting variants in samples for which the ploidy is known. As the Fixed Ploidy Variant Caller assumes, and hence can exploit, information about underlying possible allele type sites, this variant caller has particularly high *specificity* for samples for which the ploidy assumption is valid.

The Fixed Ploidy Variant Caller

The purpose of the Fixed Ploidy Variant Caller is to call variants in samples with known ploidy from read mapping data. It can detect variants in samples from haploid (e.g. bacteria), diploid (e.g. human) and polyploid (upto tetraploid) organisms (e.g. higher plants). It detects Single Nucleotide Variants (SNVs), MNVs (Multiple Nucleotide Variants), insertions, deletions as well as replacements (combinations of neighboring insertions, deletions and SNVs for which the positions are ambiguous).

The algorithm behind the Fixed Ploidy Variant Caller combines a Bayesian model with a Maximum Likelihood approach. Variants are called by examining the posterior probabilities from the Bayesian model: at any given site a variant is called if the sum of the posterior probabilities of the site types that are different from the homozygous reference allele site type is larger than the user-specified 'probability' cut-off value. The variant called is the variant that corresponds to the site type with the highest posterior probability. When evaluating the posterior probabilities in the Bayesian model, maximum likelihood estimates for the parameters of the model are used. These are obtained from the likelihood function using an Expectation Maximization (EM) approach.

The model for the Fixed Ploidy Variant Caller

The statistical model for the Fixed Ploidy Variant Caller consists of a model for the **the possible site types**, S , and their prior probabilities, $f_s, s \in S$, and for **the sequencing errors**, e .

Prior site type probabilities: The set of possible site types is determined entirely by the assumed ploidy, and consists of the set of possible underlying nucleotide allele combinations that can exist within an individual with the specified number of alleles. E.g. if the specified ploidy is 2, the individual has two alleles, and the nucleotide at each allele can either be an A , a C , a G , a T or a $-$. The set of possible types for the diploid individual's sites is thus:

$$S = \{A/A, A/C, A/G, A/T, A/-, C/C, C/G, C/T, C/-, G/G, G/T, G/-, T/T, T/-, -/-\}.$$

Note that, as we cannot distinguish the alleles from each other there are not $5 \times 5 = 25$ possible site types, but only 15 (that is, the allele combination A/C is indistinguishable from the allele combination C/A).

We let f_s denote the prior probabilities of the site types $s \in S$. The prior probabilities of the site types are the frequencies of the true site types in the mapping. The values of these are unknown, and need to be estimated from the data.

Error probabilities: The model for the sequencing errors describes the probabilities with which the sequencing machine produces the nucleotide M , when what it should have produced was the nucleotide N , (M and $N \in \{A, C, G, T, -\}$). When quality values are available for the nucleotides in the reads, we let each quality value have its own error model; if not, a single model is assumed for all nucleotides. Each error model has the following 25 parameters:

$$\{e(N \rightarrow M) | N, M \in \{A, C, G, T, -\}\}.$$

The values of these parameters are also unknown, and hence also need to be estimated from the data.

Deriving the posterior probabilities of the site types

We will call a variant at a site if the sum of the posterior probabilities of the non-homozygous reference site types is larger than the user-specified cut-off value. For this we need to be able to calculate the posterior site type probabilities. We here derive the formula for these.

Using the Bayesian approach we can write the posterior probability of a site type, t , as follows:

$$\begin{aligned} P(t|data) &= \frac{P(data|t)P(t)}{P(data)} \\ &= \frac{P(data|t)P(t)}{\sum_{s \in S} P(data|s)P(s)}, \end{aligned} \quad (25.2)$$

where $P(t)$ is the prior probability of site type t (that is, $f_s, s \in S$, from above) and $P(data|t)$ is the likelihood of the data, given the site type t . The data consists of all the nucleotides in all the reads in the mapping. For a particular site, assume that we have k reads that cover this site, and let i be an index over the nucleotides observed, n_i , in the reads at this site. We thus have:

$$P(data|t) = P(n_1, \dots, n_k|t).$$

To derive the likelihood of the data, $P(n_1, \dots, n_k|t)$, we first need some notation: For a given site type, t , let $P_t(N)$ be the probability that an allele from this site type has the nucleotide N . The $P_t(N)$ probabilities are known and are determined by the ploidy: For a diploid organism, $P_t(N) = 1$ if t is a homozygous site and N is one of the alleles in t , whereas it is 0.5 if t is a heterozygous and N is one of the alleles in t , and it is 0, if N is not one of the alleles in t . For a triploid organism, the $P_t(N)$ will be either 0, 1/3, 2/3 or 1.

With this definition, we can write the likelihood of the data n_1, \dots, n_k in a site t as:

$$P(n_1, \dots, n_k|t) = \prod_{i=1}^k \sum_{N \in \{A,C,G,T,-\}} P_t(N) \times e_q(N \rightarrow n_i). \quad (25.3)$$

Inserting this expression for the likelihood, and the prior site type frequencies f_s and f_t for $P(s)$ and $P(t)$, in the expression for the posterior probability (25.2), we thus have the following equation for the posterior probabilities of the site types:

$$\begin{aligned} P(t|n_1, \dots, n_k) &= \frac{P(n_1, \dots, n_k|t)f_t}{\sum_{s \in S} P(n_1, \dots, n_k|s)f_s} \\ &= \frac{\prod_{i=1}^k \sum_{N \in \{A,C,G,T,-\}} P_t(N) \times e_q(N \rightarrow n_i)f_t}{\sum_{s \in S} \prod_{i=1}^k \sum_{N \in \{A,C,G,T,-\}} P_s(N) \times e_q(N \rightarrow n_i)f_s} \end{aligned} \quad (25.4)$$

The unknowns in this equation are the prior site type probabilities, $f_s, s \in S$, and the error rates $\{e(N \rightarrow M)|N, M \in \{A, C, G, T, -\}\}$. Once these have been estimated, we can calculate the posterior site type probabilities using the equation 25.4 for each site type, and hence, for each site, evaluate whether the sum of the posterior probabilities of the non-homozygous reference site types is larger than the cut-off. If so, we will set out current estimated site type to be that with the highest posterior probability.

Estimating the parameters in the model for the Fixed Ploidy Variant Caller

The Fixed Ploidy Variant Caller uses the Expectation Maximization (EM) procedure for estimating the unknown parameters in the model, that is, the prior site type probabilities, $f_s, s \in S$ and the error rates $\{e(N \rightarrow M) | N, M \in \{A, C, G, T, -\}\}$. The EM procedure is an iterative procedure: it starts with a set of initial prior site type frequencies, $f_s^0, s \in S$ and a set of initial error probabilities, $\{e_q^0(N \rightarrow M) | N, M \in \{A, C, G, T, -\}\}$. It then iteratively updates first the prior site type frequencies (to get $f_s^1, s \in S$), then the error probabilities (to get $\{e_q^1(N \rightarrow M) | N, M \in \{A, C, G, T, -\}\}$), then the site type frequencies again, etc. (a total of four rounds), in such a manner that the observed nucleotide patterns at the sites in the alignment become increasingly likely. To give an example of the forces at play in this iteration: as you increase the error rates you will decrease the likelihood of observing 'clean' patterns (e.g. patterns of only *As* and *Cs* at site types *A/C*) and increase the likelihood of observing 'noisy' patterns (e.g. patterns of other than only *As*, and *C* at site types *A/C*). If, on the other hand, you decrease the error rates, you will increase the likelihood of observing 'clean' patterns and decrease the likelihood of observing 'noisy' patterns. The EM procedure ensures that the balance between these two is optimized relative to the data observed (assuming, of course, that the ploidy assumption is valid).

Updating equations for the prior site type probabilities

We first derive the updating equations for the prior site type probabilities $f_s, s \in S$. The probability that the site is of type t given that we observe the nucleotides n_1, \dots, n_k in the reads at the site is:

$$\begin{aligned} P(t | n_1, \dots, n_k) &= \frac{P(t, n_1, \dots, n_k)}{\sum_{s \in S} P(s, n_1, \dots, n_k)} \\ &= \frac{P(t)P(n_1, \dots, n_k | t)}{\sum_{s \in S} P(s)P(n_1, \dots, n_k | s)} \end{aligned} \quad (25.5)$$

Now, for $P(t)$ we use our current value for f_t , and if we further insert the expression for $P(n_1, \dots, n_k | t)$ (25.3) we get:

$$P(t | n_1, \dots, n_k) = \frac{f_t \prod_{i=1}^k \sum_{N \in \{A, C, G, T, -\}} P_t(N) \times e_q(N \rightarrow n_i)}{\sum_{s \in S} f_s \prod_{i=1}^k \sum_{N \in \{A, C, G, T, -\}} P_s(N) \times e_q(N \rightarrow n_i)} \quad (25.6)$$

We get the updating equation for the prior site type probabilities, $f_t, t \in S$, from equation 25.6: Let h index the sites in the alignment ($h = 1, \dots, H$). Given the current values for the set of site frequencies, $f_t, t \in S$, and the current values for the set of error probabilities, we obtain updated values for the site frequencies, $f_t^*, t \in S$, by summing the site type probabilities given the data (as given by equation 25.6) across all sites in the alignment:

$$f_t^* = \frac{\sum_{h=1}^H \frac{f_t \prod_{i=1}^k \sum_{N \in \{A, C, G, T, -\}} P_t(N) \times e_q(N \rightarrow n_i^h)}{\sum_{s \in S} f_s \prod_{i=1}^k \sum_{N \in \{A, C, G, T, -\}} P_s(N) \times e_q(N \rightarrow n_i^h)}}{H} \quad (25.7)$$

Updating equations for the error rates

For the updating equations for the error probabilities, we consider a read, i , at a given site, h . The joint probability of the true nucleotide in the read, r_i^h , at the site being N and the data $n_1^h, \dots, n_{k_h}^h$ is:

$$\begin{aligned}
 P(r_i^h = N, n_1^h, \dots, n_{k_h}^h) &= \sum_{s \in S} f_s P(r_i^h = N, n_1^h, \dots, n_{k_h}^h | s) \\
 &= \sum_{s \in S} f_s \prod_i P(r_i^h = N, n_i^h | s) \\
 &= \sum_{s \in S} f_s P(r_i^h = N, n_i^h | s) \prod_{j \neq i} P(n_j^h | s) \\
 &= \sum_{s \in S} f_s (P_s(N) \times e_{q_{i,h}}(N \rightarrow n_i^h)) \prod_{j \neq i} \sum_{N' \in \{A,C,G,T,-\}} P_s(N') \times e_{q_j}(N' \rightarrow n_j^h) \quad (25.8)
 \end{aligned}$$

Using Bayes formula again, as we did above in 25.5, we get:

$$\begin{aligned}
 P(r_i^h = N | n_1^h, \dots, n_{k_h}^h) &= \frac{P(r_i^h = N, n_1^h, \dots, n_{k_h}^h)}{P(n_1^h, \dots, n_{k_h}^h)} \\
 &= \frac{P(r_i^h = N, n_1^h, \dots, n_{k_h}^h)}{\sum_{N' \in \{A,C,G,T,-\}} P(r_i^h = N', n_1^h, \dots, n_{k_h}^h)} \quad (25.9)
 \end{aligned}$$

and inserting the expression from equation 25.8:

$$\begin{aligned}
 P(r_i^h = N | n_1^h, \dots, n_{k_h}^h) &= \frac{\sum_{s \in S} f(s) (P_s(N) \times e_{q_{i,h}}(N \rightarrow n_i^h)) \prod_{j \neq i} \sum_{N' \in \{A,C,G,T,-\}} P_s(N') \times e_{q_j}(N' \rightarrow n_j^h)}{\sum_{N' \in \{A,C,G,T,-\}} (\sum_{s \in S} f(s) (P_s(N') \times e_{q_{i,h}}(N' \rightarrow n_i^h)) \prod_{j \neq i} \sum_{N'' \in \{A,C,G,T,-\}} P_s(N'') \times e_{q_j}(N'' \rightarrow n_j^h))} \\
 &= \frac{\sum_{s \in S} f(s) (P_s(N) e_{q_{i,h}}(N \rightarrow n_i^h)) \prod_{j \neq i} \sum_{N' \in \{A,C,G,T,-\}} P_s(N') \times e_{q_j}(N' \rightarrow n_j^h)}{(\sum_{s \in S} f(s) \prod_j \sum_{N' \in \{A,C,G,T,-\}} P_s(N') \times e_{q_j}(N' \rightarrow n_j^h))} \quad (25.10)
 \end{aligned}$$

The equation 25.10 gives us the probabilities for a given read, i , and site, h , given the data $n_1^h, \dots, n_{k_h}^h$, that the true nucleotide is N , $N \in \{A, C, G, T, -\}$, given our current values of the error rates and site probabilities. Since we know the sequenced nucleotide in each read at each site, we can get new updated values for the error rate of producing an M nucleotide when the true nucleotide is N , $e_q^*(N \rightarrow M)$, for $N, M \in \{A, C, G, T, -\}$ by summing the probabilities of the true nucleotide being N for all reads across all sites for which the sequenced nucleotide is M , and dividing by the sum of all probabilities of the true nucleotide being a N across all reads and all sites:

$$e_q^*(N \rightarrow M) = \frac{\sum_h \sum_{i=1, \dots, k_h: n_i^h = M} P(r_i^k = N | n_1^h, \dots, n_{k_h}^h)}{\sum_h \sum_{i=1, \dots, k_h} P(r_i^k = N | n_1^h, \dots, n_{k_h}^h)}$$

25.11.2 The Low Frequency Variant caller: Models and methods

This section describes the model, method and estimation procedure behind the Low Frequency Variant Caller. The Low Frequency Variant Caller is designed to detect variants in a sample for which the ploidy is unknown. The Low Frequency Variant Caller has a particularly high *sensitivity* for detecting variants that are present at any, and in particularly at low, allele frequencies.

The model for the Low Frequency Variant Caller

The purpose of the Low Frequency Variant Caller is to call variants in samples with unknown ploidy (e.g. samples of limited tumor purity from cancer patients) using read mapping data. It will detect germline as well as somatic variants, and may also be used on samples from other high-ploidy organisms, or pooled samples. Like the Fixed Ploidy Variant Caller it detects Single Nucleotide Variants (SNVs), MNVs (Multiple Nucleotide Variants), insertions, deletions as well as replacements (combinations of neighboring insertions, deletions and SNVs for which the positions are ambiguous).

The algorithm behind the The Low Frequency Variant Caller relies on Multinomial models for the presence of different nucleotide alleles at a given site and an error model for the sequencing (the error model is identical to that of the Fixed Ploidy variant caller). The Multinomial models are of the kind "there are q different nucleotide alleles present at the site with frequencies f_i , $i = 1, \dots, q$, $\sum_{i=1}^q f_i = 1$ ", where the number of alleles, q , differ. The models that are evaluated at each site are given in Table 25.1.

Model	Alleles present at the site	Description	Free parameters*
M_x	x	the only allele present at the site is x .	none
$M_{x,y}$	x and y	x is present at frequency $1 - f$, y at frequency f	f
$M_{x,y,z}$	x , y and z	x is present at frequency $1 - (f_1 + f_2)$, y at frequency f_1 and z at frequency f_2	f_1 and f_2
$M_{x,y,z,w}$	x , y , z and w	x is present at frequency $1 - (f_1 + f_2 + f_3)$, y at frequency f_1 , z at frequency f_2 and w at frequency f_3	f_1 , f_2 and f_3
$M_{x,y,z,w,v}$	x , y , z , w and v	x is present at frequency $1 - (f_1 + f_2 + f_3)$, y at frequency f_1 , z at frequency f_2 , w at frequency f_3 and v at frequency f_4	f_1 , f_2 , f_3 and f_4

Table 25.1: The Multinomial models evaluated at each site. X, Y, Z, W and V each take on one of the values A, C, G, T , or $-$ ($X \neq Y \neq Z \neq W \neq V$). Free parameters*: the parameters that are free in each of the Multinomial models of the Low Frequency Variant Caller.

In words, model M_x can be described as: "There is really only the X nucleotide allele present at the site, *all other nucleotides are due to errors*" and model $M_{x,y,z}$ as: "There are really only the nucleotide alleles X, Y and Z present at the site, *all other nucleotides are due to errors*". The hypotheses where a single nucleotide is present in the sample have no free parameters (there is just one frequency parameter and it must be 1). A hypothesis stating that a site is a mixture of two different nucleotides, e.g. [A/G] has one free parameter since there are frequencies for two nucleotides but they have to sum to one.

Parameter estimation relies on the Maximum Likelihood principle, and, as the Fixed Ploidy Variant Caller, the EM algorithm is used for estimating the parameters of the model. Given an initial set of parameter values for the error rates, the different Multinomial models are evaluated at each site by finding the maximum likelihood estimates of the frequency parameters for each model. The model that offers the best explanation of the data (while taking care to adjust for the numbers of parameters in the Multinomial model, using a criterion adopted from the Akaike Information criterion) is chosen as the current guess of the true allelic situation at that site, and given that, the error rates are re-estimated. Given the new error estimates, the Maximum Log Likelihoods for all possible Multinomial models are again evaluated and updated frequencies are produced. This procedure is performed a total of four times. After the final round of estimation the Multinomial model that offers the best explanation of the data is chosen as the winning model, and variants are called according to that model.

Below we describe in detail how we choose among competing models and derive the updating equations for the EM estimation of the frequency and error rate parameters.

Updating the choice of favored Multinomial model for each site

Given a set of error rates, and, for each site, a set of Maximum Likelihood estimates of the nucleotide allele frequencies for each Multinomial model, we can calculate the Maximum loglikelihood values for each of the models at each site. Since the hypotheses with fewer free parameters are special cases of hypotheses with more free parameters, the hypotheses with the most free parameters will necessarily have the highest likelihoods. We wish to only favor a model with more parameters over one with fewer, if it offers a significantly better explanation of the data at the site. In the simple case where we have nested models (e.g. a hypothesis, H_0 , with no free parameters and an alternative hypothesis, H_1 , which has one free parameter and contains H_0 as a special case) it is a well known result that twice the loglikelihood ratio is approximately χ^2 distributed with a parameter that is equal to the difference between the number of free parameters in the hypotheses, n :

$$2 \log \frac{L(H_1)}{L(H_0)} \sim \chi^2(n).$$

If we write $c_n(p)$ for the inverse cumulative probability density function for a $\chi^2(n)$ distribution evaluated at $1 - p$, we get a cutoff value for when we prefer H_1 over H_0 at the significance level given by p .

We wish to compare all models together and some of these will not be nested. We therefore generalize this approach to apply to any set of Multinomial model hypothesis H_m , $m = 1, \dots, M$. For each model we calculate the value:

$$v_m = 2 \log L(H_m) - c_{df_m}(p) \quad (25.11)$$

where df_m is the number of free parameters in hypothesis H_m . We now prefer the hypothesis with the highest value of v (note that when comparing a hypothesis with zero free parameters to another hypothesis, we get exactly the same results as with the log likelihood ratio approach). If this hypothesis is that only the reference allele is present at the site, no variants are called. For other models, the variants corresponding to the alleles hypothesized by the models are called.

The approach applied is an extension of the Akaike approach: In the Akaike approach you subtract twice the number of parameters, whereas in the approach that we apply, we subtract $c_{df_x}(p)$, whereby additional parameters are punished relative to the significance level, p , rather than in a fashion that is linear in the number of parameters. This means that the more parameters that are present, the more reluctant we will be to add even more.

Updating equations for the Multinomial model frequency parameters

Consider a site, h , and let n_i^h be the nucleotide observed in read i at this site, $i = 1, \dots, k$. For each of the Multinomial models that may explain the data at the site we have a number of frequency parameters. For simplicity, we consider the model which states that there are two alleles present at the site, the reference allele, y , and another allele x , and let f be the frequency parameter for the non-reference allele (hence the frequency of the reference allele, f_y , is $1 - f$). Models with more alleles are treated in a similar manner.

We want to estimate the parameter for the frequency of the x allele at the site h , f , by the fraction of true nucleotides that are x at this site, given the observed data:

$$f^* = \frac{\sum_{i=1}^k P(r_i^h = x | n_i^h)}{k} \quad (25.12)$$

To calculate this we use Bayes Theorem on the numerator:

$$P(r_i^h = x | n_i^h) = \frac{P(r_i^h = x, n_i^h)}{P(n_i^h)} \quad (25.13)$$

$$= \frac{P(x) \times e(x \rightarrow n_i^h)}{P(x) \times e(x \rightarrow n_i^h) + P(y) \times e(y \rightarrow n_i^h)} \quad (25.14)$$

$$= \frac{f \times e(x \rightarrow n_i^h)}{f \times e(x \rightarrow n_i^h) + (1 - f) \times e(y \rightarrow n_i^h)} \quad (25.15)$$

Inserting our current values for the frequency parameter f under the model, and the error rates $e(x \rightarrow n_i^h)$ and $e(y \rightarrow n_i^h)$, in 25.13, and further inserting the obtained values in 25.12 gives us updated values for the frequency parameter f .

Updating equations for the error rates

Consider a site h and a read i . The joint probability of the true nucleotide in the read, r_i^h , at the site being N and the observed nucleotide at the site n_i^h is:

$$P(r_i^h = N, n_i^h) = P_h(N) e_{q_i^h}(N \rightarrow n_i^h). \quad (25.16)$$

Using Bayes Theorem, the probability of the true nucleotide in the read, r_i^h , at the site being N , given that we observe n_i^h is:

$$P(r_i^h = N | n_i^h) = \frac{P(r_i^h = N, n_i^h)}{\sum_{N' \in A, C, G, T, -} P(r_i^h = N', n_i^h)}. \quad (25.17)$$

Inserting 25.16 in 25.17 we get:

$$P(r_i^h = N | n_i^h) = \frac{P_h(N) e_{q_i^h}(N \rightarrow n_i^h)}{\sum_{N' \in A, C, G, T, -} P_h(N') e_{q_i^h}(N' \rightarrow n_i^h)}. \quad (25.18)$$

The equation 25.18 gives us the probabilities for a given read, i , and site, h , given the observed nucleotide n_i^h , that the true nucleotide is N , $N \in \{A, C, G, T, -\}$, given our current values for the frequency f (inserted for $P_h(N)$) and error rates. Since we know the sequenced nucleotide in each read at each site, we can get new updated values for the error rate of producing an M nucleotide when the true nucleotide is N , $e_q^*(N \rightarrow M)$, for $N, M \in \{A, C, G, T, -\}$ by summing the probabilities of the true nucleotide being N for all reads across all sites for which the sequenced nucleotide is M , and dividing by the sum of all probabilities of the true nucleotide being a N across all reads and all sites:

$$e_q^*(N \rightarrow M) = \frac{\sum_h \sum_{i=1, \dots, k_h: n_i^h = M} P(r_i^h = N | n_i^h)}{\sum_h \sum_{i=1, \dots, k_h} P(r_i^h = N | n_i^h)}$$

Probability of the variant

A probability value is reported for each variant call in the variant track table column with the header "Probability". For the Fixed Ploidy Variant Caller this value is the posterior probability of the site being different from the homozygous reference site. This is possible to calculate because the model behind the Fixed Ploidy Variant Caller is Bayesian. As the model for the Low Frequency Variant Caller is not a Bayesian model, such a value strictly speaking does not exist. However, as a proxy for such a value we report the support for the winning model m relative to the total support of all models:

$$P_m = \frac{e^{v_m}}{\sum_{m'} e^{v_{m'}}$$

25.12 Variant data

Variant data may be obtained either by importing variants from files (e.g. gvf or vcf files - as described in section 6.2), by downloading variants from external databases (e.g. dbSNP, HapMap, or 1000genomes - (described in section 6.2)) or by calling variants on read tracks or read mappings using the CLC Basic Variant Detection (section 25.7), Fixed Ploidy Variant Detection (section 25.5), or the Low Frequency Variant Detection (section 25.6) tools.

Variant types include SNVs, MNVs, insertions, deletions or replacements. They may be presented either in a variant track (see figure 25.48) or in an annotated variant table (see figure 25.51).

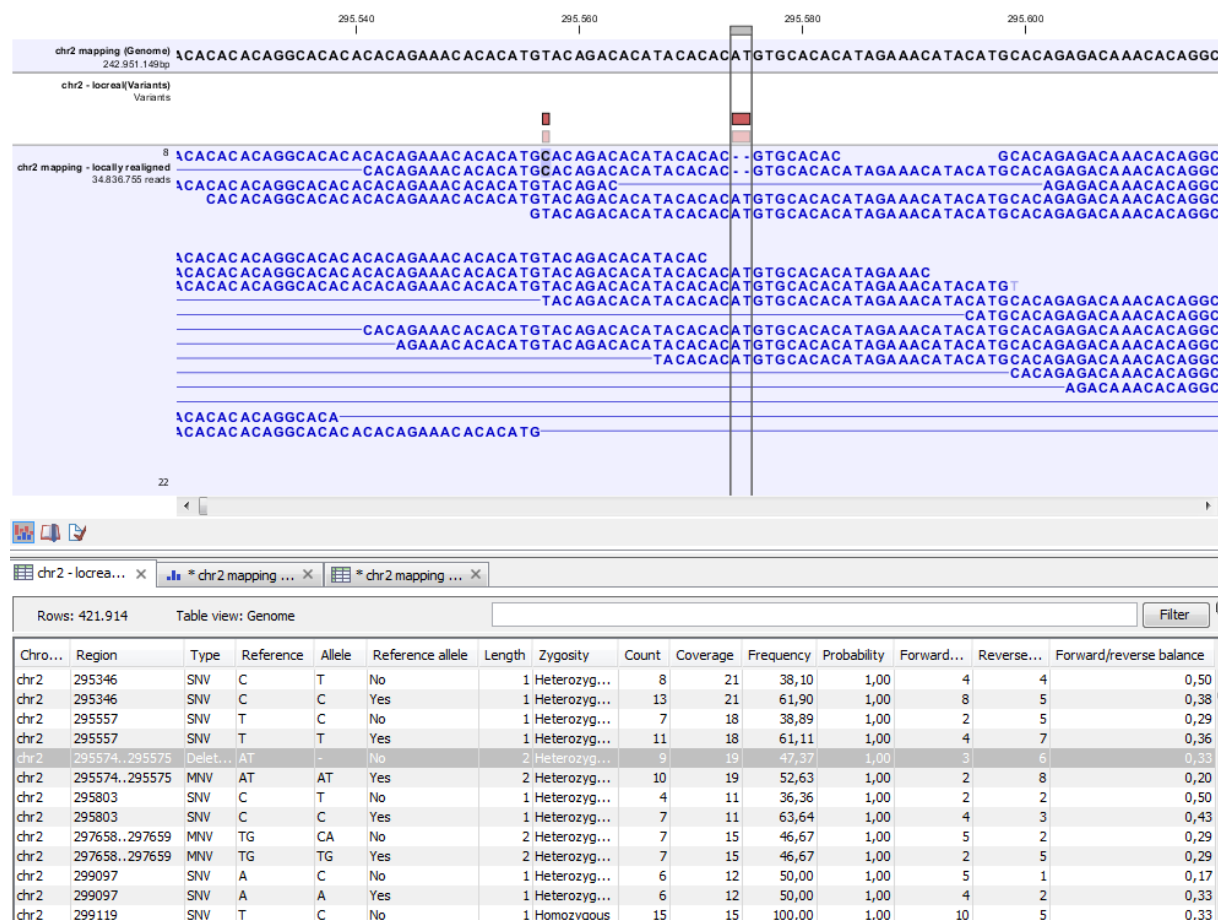

Figure 25.48: Variant track. The figure shows a track list (top), consisting of a reference sequence track, a variant track and a read mapping. The variant track was produced by running the Fixed Ploidy Variant Detection tool on the read track. The variant track has been opened in a separate table view by double-clicking on it in the track list. By selecting a row in the variant track table, the track list view is centered on the corresponding variant.

25.12.1 Variant tracks

A variant track (figure 25.48), created with the CLC Genomics Workbench variant callers (see section 25.4), has the following information for each variant:

Chromosome The name of the reference sequence on which the variant is located.

Region The region on the reference sequence at which the variant is located. The region may be either a 'single position', a 'region' or a 'between position region'. Examples are given in figure 25.49. An extract of a gvf-file giving rise to these three variants after import is shown in figure 25.50.

Variant type The type of variant. This can either be SNV (single-nucleotide variant), MNV (multi-nucleotide variant), insertion, deletion, or replacement. Learn more in section 25.12.3.

Reference The reference sequence at the position of the variant.

Allele The allele sequence of the variant.

Reference allele Describes whether the variant is identical to the reference. This will be the case one of the alleles for most, but not all, detected heterozygous variants (e.g. the variant caller might detect two variants, A and G, at a given position in which the reference is 'A'. In this case the variant corresponding to allele 'A' will have 'Yes' in the 'reference allele' column entry, and the variant corresponding to allele 'G' would have 'No'. Had the variant caller called the two variants 'C' and 'G' at the position, both would have had 'No' in the 'Reference allele' column).

Length The length of the variant. The length is 1 for SNVs, and for MNVs it is the number of allele or reference bases (which will always be the same). For deletions, it is the length of the deleted sequence, and for insertions it is the length of the inserted sequence. For replacements, both the length of the replaced reference sequence and the length of the inserted sequence are considered, and the longest of those two is reported.

Zygosity The zygosity of the variant called, as determined by the variant caller. This will be either 'Homozygous', where there is only one variant called at that position or 'Heterozygous' where more than one variant was called at that position.

Count The number of 'countable' reads supporting the allele. The 'countable' reads are those that are used by the variant caller when calling the variant. Which reads are 'countable' depends on the user settings when the variant calling is performed - if e.g. the user has chosen 'Ignore broken pairs', reads belonging to broken pairs are not 'countable'.

Coverage The read coverage at this position. Only 'countable' reads are considered (see under 'Count' above for an explanation of 'countable' reads. Also see overlapping pairs in section 25.13 for how overlapping paired reads are treated.)

Frequency The number of 'countable' reads supporting the allele divided by the number of 'countable' reads covering the position of the variant ('see under 'Count' above for an explanation of 'countable' reads). Please see section 25.14.6 for a description of how to remove low-frequency variants.

Probability The probability that this particular variant exists in the sample. (For further information please refer to the White paper on Probabilistic Variant Caller: http://resources.qiagenbioinformatics.com/white-papers/White_paper_on_probabilistic_variant_caller_1.1.pdf).

Forward read count The number of 'countable' forward reads supporting the allele (see under 'Count' above for an explanation of 'countable' reads). Also see more information about overlapping pairs in section 25.13.

Reverse read count The number of 'countable' reverse reads supporting the allele (see under 'Count' above for an explanation of 'countable' reads). Also see more information about overlapping pairs in section 25.13.

Forward/reverse balance The minimum of the fraction of 'countable' forward reads and 'countable' reverse reads carrying the variant among all 'countable' reads carrying the variant (see under 'Count' above for an explanation of 'countable' reads).²

²Some systematic sequencing errors can be triggered by a certain combination of bases. This means that sequencing one strand may lead to sequencing errors that are not seen when sequencing the other strand (see [Nguyen et al., 2011] for a recent study with Illumina data). In order to evaluate whether the distribution of forward and reverse reads is approximately random, this value is calculated as the minimum of the number of forward

Average quality The average read quality score of the bases supporting a variant. See section 25.14.6 on how to remove variants that have a low average quality. If there are no values in this column, it is probably because the sequencing data was imported without quality scores (learn more about importing quality scores from different sequencing platforms in section 6.3). For deletions, the quality scores of the two surrounding bases are taken into account, and the lowest value of these two is reported.

Hyper-allelic Relevant for "Basic Variant Detection". Reports hyper-allelic status of variants based on the specified threshold "Maximum expected allele" in the "Set genome information" wizard under "Ploidy". The output in the table is "Yes" or "No" with respect to whether the threshold has been exceeded.

QUAL This value is necessary for certain downstream analyses of the data after export in vcf format. It is calculated as

$$-10 \log_{10}(1 - p) \quad (25.19)$$

p being the probability that a particular variant exists in the sample (see above for the definition of probability). QUAL is capped at 200 for $p=1$.

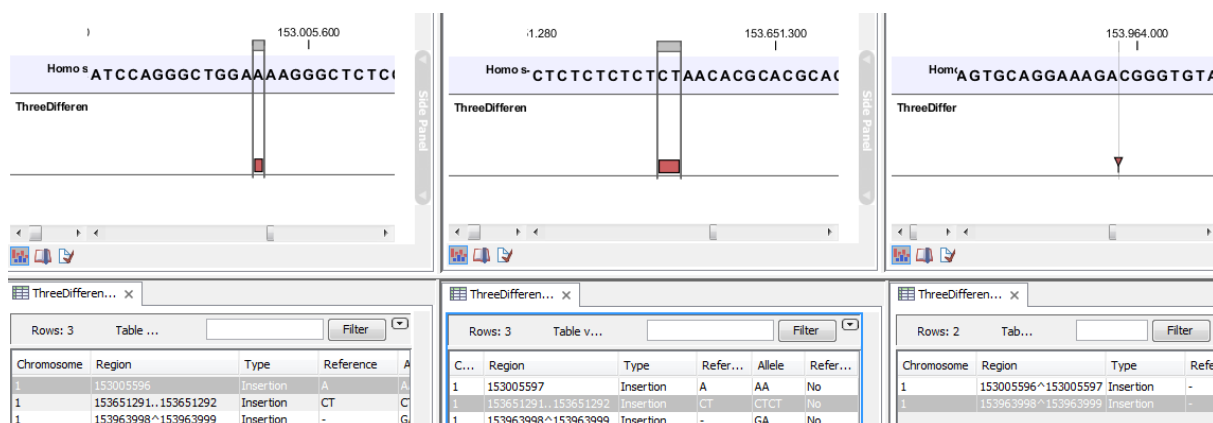

Figure 25.49: Examples of variants with different types of 'Region' column contents. The left-most variant has a 'single position' region, the middle variant has a 'region' region and the right-most has a 'between positions' region.

Please note that the variants in the variant track can be enriched with information using the annotation tools in section 25.14.

A variant track can be imported and exported in VCF or GVF formats. An example of the gvf-file giving rise to the variants shown in figure 25.49 is given in figure 25.50.

```
##gff-version 3
##gvf-version 1.06
##file-date 2013-09-23
##file-encoding windows-1252
1 CLC insertion 153005596 153005596 0 . . ID=CLC_1;Variant_seq=AA;Reference_seq=A;
1 CLC insertion 153651291 153651292 0 . . ID=CLC_2;Variant_seq=CTCT;Reference_seq=CT;
1 CLC insertion 153963998 153963999 0 . . ID=CLC_3;Variant_seq=GA;Reference_seq=-;
```

Figure 25.50: A gvf file giving rise to the variants in the figure above.

reads divided by the total number of reads and the number of reverse reads divided by the total number of reads supporting the variant. An equal distribution of forward and reverse reads for a given allele would give a value of 0.5. (See also more information about overlapping pairs in section 25.13.)

25.12.2 The annotated variant table

While the track table contains reference alleles and non-reference alleles, the annotated table lists only non-reference alleles. It include for each allele a subset of the columns of the variant track table and three additional columns (see figure 25.51).

Reference...	Type	Reference	Allele	Overlapping annotations	Coding region change	Amino acid change
3574524	SNV	T	C			
3574532	SNV	T	C			
3574536	SNV	T	C			
3575808	SNV	A	T	Gene: TEP1, mRNA: TEP1		
3655632	SNV	C	A	Gene: OSGEP, CDS: OSGEP, mRNA: OSGEP	NP_060277.1:c.681G>T	NP_060277.1:p.Glu227Asp
3655679	Deletion	A	-	Gene: OSGEP	NP_060277.1:c.637-3delT	
3655684	SNV	T	G	Gene: OSGEP	NP_060277.1:c.637-8A>C	
3656277	SNV	C	T	Gene: OSGEP, CDS: OSGEP, mRNA: OSGEP	NP_060277.1:c.597G>A	
3656304	SNV	T	C	Gene: OSGEP, CDS: OSGEP, mRNA: OSGEP	NP_060277.1:c.570A>G	

Figure 25.51: An example of an annotated variant table.

When the variant calling is performed on a read mapping in which gene and cds annotations are present on the reference sequence, the three columns will contain the following information:

Overlapping annotation This shows if the variant is covered by an annotation. The annotation's type and name will displayed. For annotated reference sequences, this information can be used to tell if the variant is found in e.g. a coding or non-coding region of the genome. **Note** that annotations of type `Variation` and `Source` are not reported.

Coding region change For variants that fall within a coding region of a gene, the change is reported according to the standard conventions as outlined in <http://www.hgvs.org/mutnomen/>.

Amino acid change If the reference sequence of the mapping is annotated with ORF or CDS annotations, the variant caller will also report whether the variant is synonymous or non-synonymous. If the variant changes the amino acid in the protein translation, the new amino acid will be reported. The nomenclature used for reporting is taken from <http://www.hgvs.org/mutnomen/>.

If the reference sequence has no gene and cds annotations these columns will have the entry 'NA'. Note that the variant track may be enriched with information similar to that contained in the above three annotated variant table columns by using the track-based annotation tools in section 25.14).

The table can be **Exported** (📄) as a csv file (comma-separated values) and imported into e.g. Excel. Note that the CSV export includes all the information in the table, regardless of filtering and what has been chosen in the **Side Panel**. If you only want to use a subset of the information, simply select and **Copy** (📋) the information.

Note that if you make a split view of the table and the mapping (see section 2.1.7), you will be able to browse through the variants by clicking in the table. This will cause the view to jump to the position of the variant.

This table view is not well-suited for downstream analysis, in which case we recommend working with tracks instead (see section 25.12.1).

25.12.3 Variant types

Variants are classified into five different types:

SNV A single nucleotide variant. This means that one base is replaced by one other base. This is also often referred to as a SNP. *SNV* is preferred over *SNP* because the latter includes an extra layer of interpretation about variants in a population. This means that an SNV could potentially be a SNP but this cannot be determined at the point where the variant is detected in a single sample.

MNV This type represents two or more SNVs in succession.

Insertion This refers to the event where one or more bases are inserted in the experimental data compared to the reference.

Deletion This refers to the event where one or more bases are deleted from the experimental data compared to the reference.

Replacement This is a more complex event where one or more bases have been replaced by one or more bases, where the identified allele has a length different from the reference (i.e. involving an insertion or deletion). Basically, this type represents variants that cannot be represented in the other four categories. An example could be `AAA->CC`. This cannot be resolved into a SNV or an MNV because the number of bases is different between the experimental data and the reference, it is not an insertion because something is also deleted from the reference, and it is not a deletion because something is also inserted.

25.13 Detailed information about overlapping paired reads

Paired reads that overlap introduce additional complexity for variant detection. This section describes how this is handled by *CLC Genomics Workbench*.

When it comes to **coverage** in the overlapping region, each pair is contributing once to the coverage. Even if there are indeed two reads in this region, they do not both contribute to coverage. The reason is that the two reads represent the same fragment, so they are essentially treated as one.

When it comes to counting the number of **forward and reverse reads**, including the forward/reverse reads balance, each read contribute. This is because this information is intended to account for systematic sequencing errors in one direction, and the fact that the two reads are from the same fragment is less important than the fact that they are sequenced on different strands.

If the two overlapping reads do not agree about the variant base, they are both ignored. Please note that there can be a special situation with the basic variant detection: If the two reads disagree, and one read does not pass the quality filter, the other read will contribute to the variant just as if there had been only that read and no overlapping pair.

25.14 Annotate and filter variants

In addition to the general filter for track tables, including the ability to create a new track from a selection (see section 23.1.3), there are a number of tools for general filtering and annotation of variants (for functional annotation and filtering, see section 25.16).

25.14.1 Filter against known variants

Comparison with known variants from variant databases is a key concept when working with resequencing data. The *CLC Genomics Workbench* provides two tools for facilitating this task: one for *annotating* your experimental variants with information from known variants (e.g. adding information about phenotypes like cancer associated with a certain variant allele), and one for *filtering* your experimental variants based on this information (e.g. for removing common variants). The first tool is explained in the next section, while this section explains the latter.

Any variant track can be used as the "known variants track". It may either be produced by the *CLC Genomics Workbench*, imported or downloaded from variant database resources like dbSNP, 1000 genomes, HapMap etc. (see section 6.2 and section 7.1).

This section will use the filter tool as an example, since the core of the tools are the same:

Toolbox | Resequencing (🔧) | Annotate and Filter Variants | Filter against Known Variants

This opens a dialog where you can select a variant track (🔗) with experimental data that should be filtered.

Clicking **Next** will display the dialog shown in figure 25.52

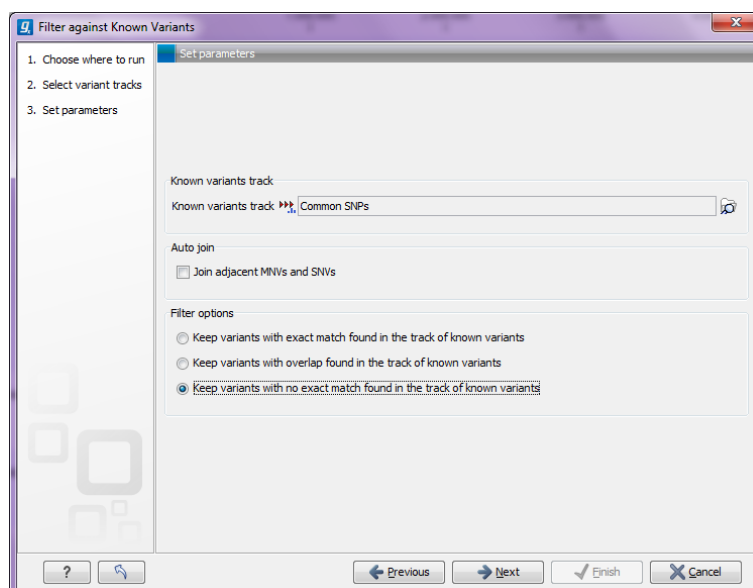

Figure 25.52: Specifying a variant track to filter against.

Select (🔗) one or more tracks of known variants to compare against. The tool will then compare each of the variants provided in the input track with the variants in the track of known variants. There are three modes of filtering:

Keep variants with exact match found in the track of known variants This will filter away all variants that are not found in the track of known variants. This mode can be useful for filtering against tracks with known disease-causing mutations, where the result will only include the variants that match the known mutations. The criteria for matching are simple: the variant position and allele both have to be identical in the input and the known variants track (however, note the extra option for joining adjacent SNVs and MNVs described below). For each variant found, the result track will include information from the known variant.

Please note that the exact match criterion can be too stringent, since the database variants need to be reported in the exact same way as in the sample. Some databases report adjacent indels and SNVs separately, even if they would be called as one replacement using the variant detection of *CLC Genomics Workbench*. In this case, we recommend using the overlap option instead and manually interpret the variants found.

Keep variants with overlap found in the track of known variants The first mode is based on exact matching of the variants. This means that if the allele is reported differently in the set of known variants, it will not be identified as a known variant. This is typically not the case with isolated SNVs, but for more complex variants it can be a problem. Instead of requiring a strict *match*, this mode will keep variants that *overlap* with a variant in the set of known variants. The result will therefore also include all variants that have an exact match in the track of known variants. This is thus a more conservative approach and will allow you to inspect the annotations on the variants instead of removing them when they do not match. For each variant, the result track will include information about overlapping or strictly matched variants to allow for more detailed exploration.

Keep variants with no exact match found in the track of known variants This mode can be used for filtering away common variants if they are not of interest. For example, you can download a variant track from 1000 genomes or dbSNP and use that for filtering away common variants. This mode is based on exact match.

Since many databases do not report a succession of SNVs as one MNV, it is not possible to directly compare variants called with *CLC Genomics Workbench* with these databases. In order to support filtering against these databases anyway, the option to **Join adjacent SNVs and MNVs** can be enabled. This means that an MNV in the experimental data will get an exact match, if a set of SNVs and MNVs in the database can be combined to provide the same allele.

Note! This assumes that SNVs and MNVs in the track of known variants represent the same allele, although there is no evidence for this in the track of known variants.

25.14.2 Annotating from known variants

Section 25.14.1 describes how to filter against known variants, but the *CLC Genomics Workbench* also includes a tool to annotate from known variants:

To run the Annotating from known variants tool, go to:

Toolbox | Resequencing  | Annotate and Filter | Annotate from Known Variants

This tool will create a new track with all the experimental variants including added information about overlapping variants found in the track of known variants. The annotations are marked in three different ways:

Exact match This means that the variant position and allele both have to be identical in the input and the known variants track (however, note the extra option for joining adjacent SNVs and MNVs described below).

Partial MNV match This applies to MNVs which can be annotated with partial matches if an SNV or a shorter MNV in the database has an allele sequence that is contained in the allele sequence of the annotated MNV.

Overlap This will report if the known variant track has an overlapping variant.

For exact matches, all the information about the variant from the known variants track is transferred to the annotated variant. For partial matches and overlaps, the information from the known variants are not transferred.

25.14.3 Annotate with exon numbers

Given a track with mRNA annotations, a new track will be created in which variants are annotated with the numbering of the corresponding exon with numbered exons based on the transcript annotations in the input track (see an example of a result in figure 25.53).

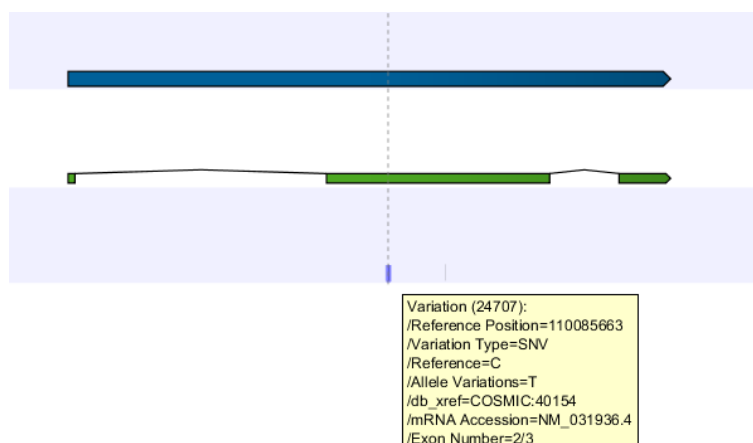

Figure 25.53: A variant found in the second exon out of three in total.

When there are multiple isoforms, a comma-separated list of the exon numbers is given.

25.14.4 Annotate with flanking sequence

In some situations, it is useful to see a variant in the context of the bases of the reference sequence. This information can be added using the **Annotate with Flanking Sequence** tool:

Toolbox | Resequencing  | **Annotate and Filter** | **Annotate with Flanking Sequence**

This opens a dialog where you can select a variant track  to be annotated.

Clicking **Next** will display the dialog shown in figure 25.54

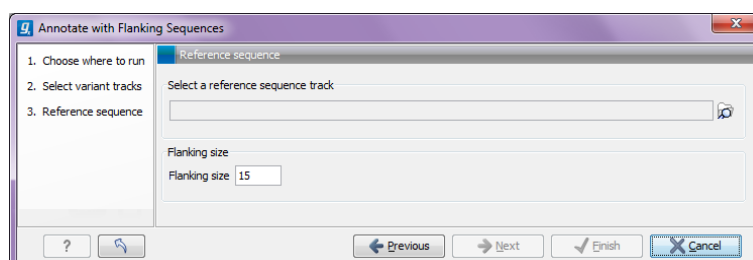

Figure 25.54: Specifying a reference sequence and the amount of flanking bases to include.

Select a sequence track that should be used for adding the flanking sequence, and specify how large the flanking region should be.

The result will be a new track with an additional column for the flanking sequence formatted like this: CGGCT [T] AGTCC with the base in square brackets being the variant allele.

25.14.5 Identify candidate variants

The **Identify Candidate Variants** tool can be used to identify and extract variants that fulfill certain criteria. This is done using filter criteria that is defined in a wizard step, while running the **Identify Candidate Variants** tool. The **Identify Candidate Variants** tool takes tracks with annotated or non-annotated variants as input.

To run the Identify candidate variants, go to the toolbox:

Toolbox | Resequencing  | **Annotate and Filter Variants** | **Identify candidate variants** 

An example of a filter criterion is shown in figure 25.55 where you filter away all variants that are not found on chromosome 1 and that are not homozygous. As a result you will only keep the variants that are homozygous and found on chromosome 1.

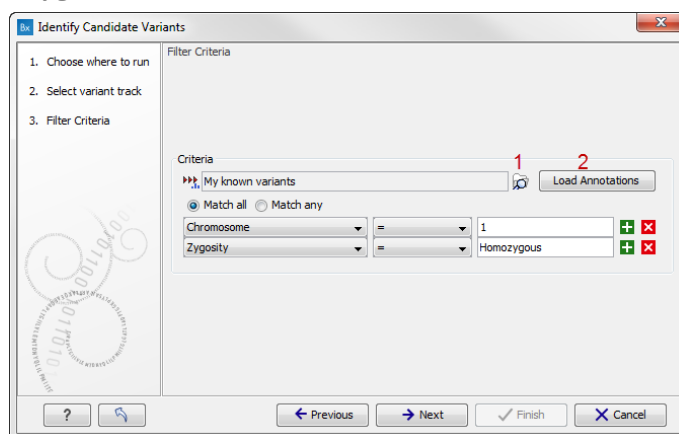

Figure 25.55: Create filter criteria to extract the variants of interest. In this example we will extract the homozygous variants found on chromosome 1. Click on the folder icon (marked with the number 1) to select a guidance track that allows you to easily select the available column headers that can be used for filtering. Click on "Load Annotations" (marked with the number 2) to load the annotations.

The best way to use the tool is to use your variant track as a guidance variant track to load all the column headers into a filter criteria drop-down list (see figure 25.55). This is done in the following way:

1. Click on the folder icon in the wizard.
2. Select a variant track that has the terms that you would like to filter on (this variant track is only used as a guidance track that allows you to choose the column headers (or other words that can be used for filtering) from a drop down list. The alternative is to write the column headers manually).
3. Click on the button labeled "Load Annotations" to load your annotated variant track that is to be used as template. The track is used as a guidance variant track in order to obtain

the annotation categories (annotation column headers) to be used for selection of which annotations the filter should be applied to.

Caution! Please note, that when you create filter criteria, you should use a guiding variant track that contains the same annotations as the annotations that are present in the variant tracks that you would like to filter.

The output from the **Identify Candidate Variants** tool is a variant track (and table) that contains only the variants that fulfill the specified filter criteria.

25.14.6 Filter marginal variant calls

Variant calling is always a balance between sensitivity and specificity. To get rid of potential false positive variants, you can use this tool on a variant track to remove some of the variant calls, which are supported by only low quality bases, have low frequency or a skewed forward-reverse reads balance. In this way, you can try different strategies for filtering without re-running the variant detection.

Toolbox | Resequencing (🔍) | Annotate and Filter | Filter Marginal Variant Calls

This opens a dialog where you can select a variant track (🔍) with experimental data that should be filtered.

Click **Next** to set the filtering thresholds as shown in figure 25.56

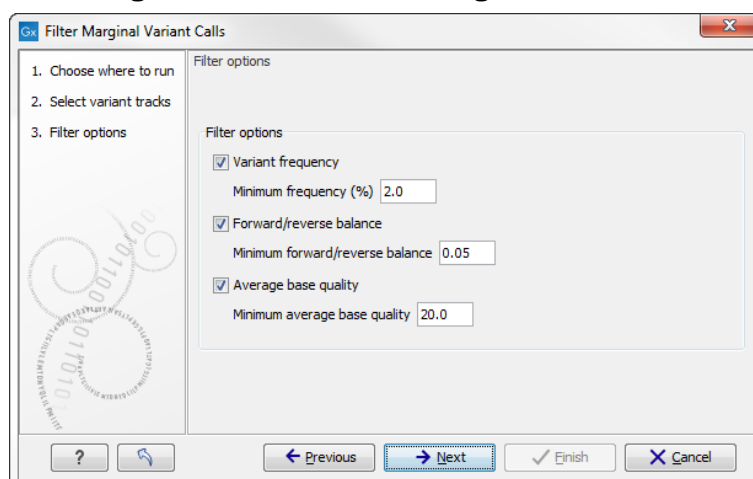

Figure 25.56: Specifying thresholds for filtering.

The following thresholds can be specified. All alleles except the reference allele are investigated separately, but in order to remove a variant, all non-reference alleles have to fulfill the requirements.

Variant frequency The frequency filter will remove all variants having alleles with a frequency (= number of reads supporting the allele/number of all reads) lower than the given threshold.

Forward/reverse balance The forward/reverse balance filter will remove all variants having alleles with a forward/reverse balance of less than the given threshold.

Average base quality The average base quality filter will remove all variants having alleles with an average base quality of less than the given threshold.

If several thresholds are applied, just one needs to be fulfilled to discard the allele. For more information about how these values are calculated, please refer to section [25.12.1](#).

The result is a new track where all variants (or at least one non-reference allele of the variant) fulfill the criteria.

25.14.7 Filter reference variants

The variant tracks produced by the variant detection tools of *CLC Genomics Workbench* include reference alleles complementing a non-reference allele (i.e. a heterozygous variant where only one allele is different from the reference). In some situations, this information is not necessary, and these reference allele variants can be filtered away

Toolbox | Resequencing  | Annotate and Filter | Filter Reference Variants

This opens a dialog where you can select a variant track () that should be filtered.

Clicking **Next** and **Finish** to create a new track without the reference variants.

25.15 Comparing variants

In the toolbox, the folder **Compare Variants** contains tools that can be used to compare experimental variants. The two tools **Compare Sample Variant Tracks** and **Compare Variants within Group** are similar to the **Filter against Known Variants** found in the **Annotate and Filter Variants** folder. The main difference is how the tools are used. The **Filter against Known Variants** should be used when comparing experimental variants with variant databases, and the other tools when comparing experimental variants with other experimental variants.

25.15.1 Compare variants within group

This tool should be used if you are interested in finding common (frequent) variants in a group of samples. For example one use case could be that you have 50 unrelated patients with the same disease and would like to identify variants that are present in at least 70% of all patients. It can also be used to do an overall comparison between samples (a frequency threshold of 0% will report all alleles).

Toolbox | Resequencing  | Compare Variants | Compare Variants within Group

This opens a dialog where you can select the variant tracks () from the samples in the group.

Clicking **Next** will display the dialog shown in figure [25.57](#).

The **Frequency threshold** is the percentage of samples that have this variant. Setting it to 70% means that at least 70% of the samples selected as input have to contain a given variant for it to be reported in the output.

The output of the analysis is a track with all the variants that passed the frequency thresholds and with additional reporting of:

Sample count The number of samples that have the variant

Total number of samples The total number of samples (this will be identical for all variants).

Sample frequency This is the same frequency that is also used as a threshold (see figure [25.57](#)).

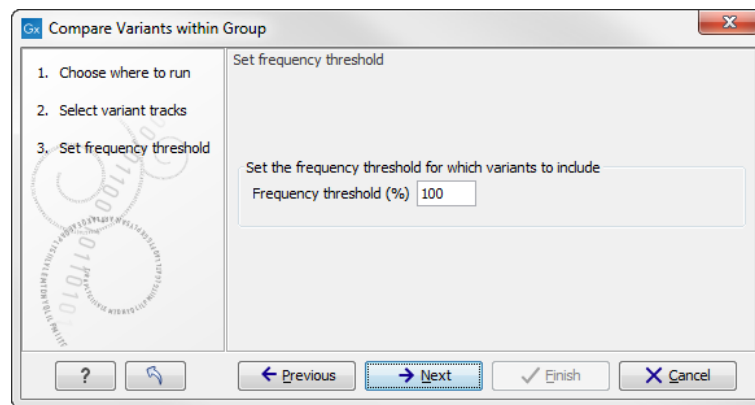
Figure 25.57: *Frequency threshold.*

Origin tracks A comma-separated list of the name of the tracks that contain the variant.

Note that this tool can be used for merging all variants from a number of variant tracks into one track by setting the frequency threshold to 0.

25.15.2 Compare sample variants

The **Compare Sample Variant Tracks** tool allows you to compare two samples and filter away the variants that are either identical or different. If you want to focus on variants that are found in both samples you should choose the option "Keep variants that are the same". These variants will be the same no matter which sample was selected as the first input (the "variant track") or the second input (the "comparison track", which also is a variant track).

If you want to focus on variants that differ between the two tracks, the order in which the two samples are selected matters, as the tool will not combine the variants in the two tracks, but will filter out one. This is illustrated in figure 25.58.

To run the tool:

Toolbox | Resequencing (📁) | Compare Variants | Compare Sample Variant Tracks

In the first step of the dialog, you select the variant track that should be taken as input. Clicking **Next** shows the dialog in figure 25.59.

At the top, select the comparison track. Below, you can choose whether the result should be the variants from the input that match the comparison track, or whether it should be the variants that are different from the variant track. The match criterion here is an exact match on the position and allele sequence.

25.15.3 Fisher exact test

This tool should be used if you have a case-control study. This could be patients with a disease (case) and healthy individuals (control). The Fisher Exact Test will identify variants that are significantly more common in the case samples than in the control samples.

Toolbox | Resequencing (📁) | Compare Variants | Fisher Exact Test

In the first step of the dialog, you select the case variant tracks. Clicking **Next** shows the dialog

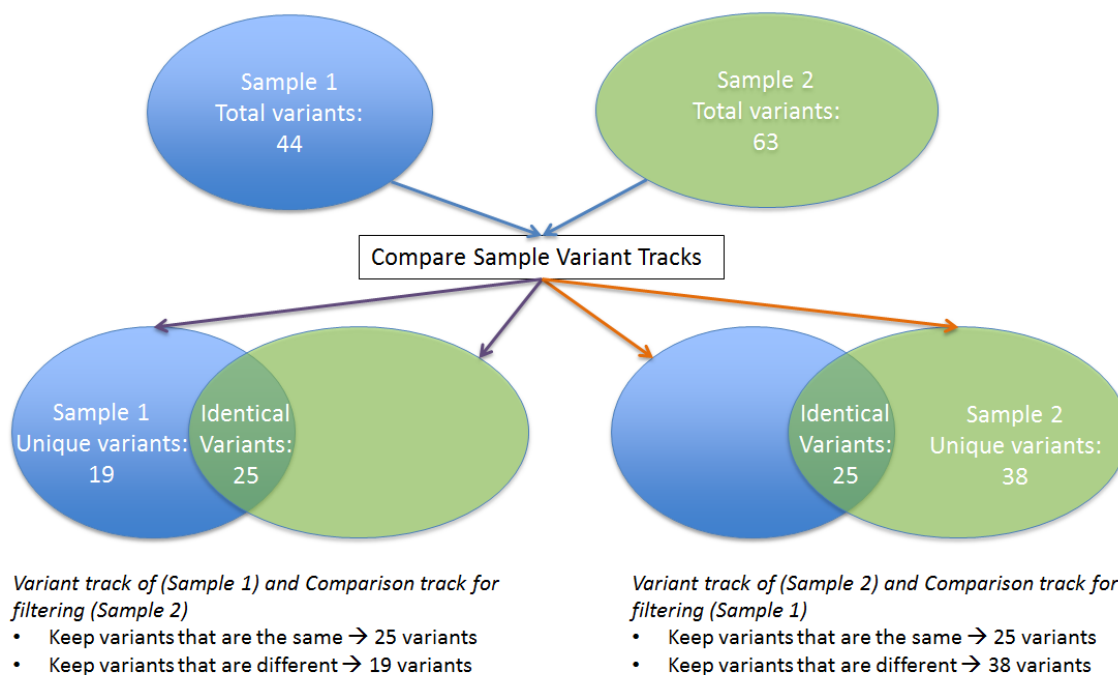

Figure 25.58: The figure illustrates the different types of output you will get depending on which choices you have made in the wizard steps.

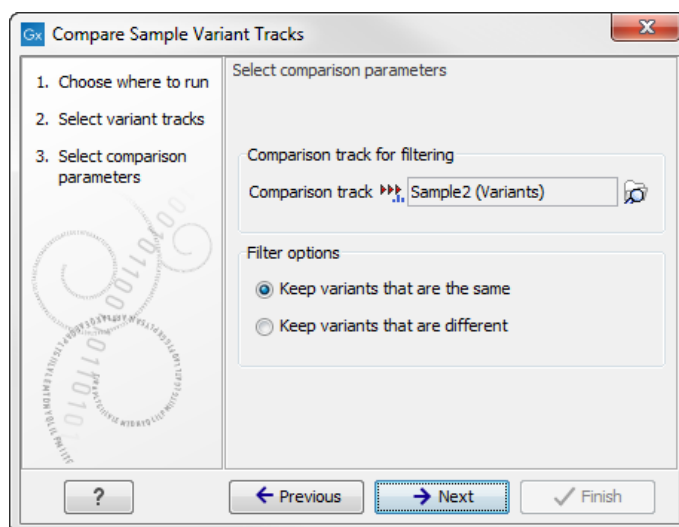

Figure 25.59: Comparing against variants in "Sample 2".

in figure 25.60.

At the top, select the variant tracks from the control group. Furthermore, you must set a threshold for the p-value (default is 0.05); only variants having a p-value below this threshold will be reported. You can choose whether the threshold p-value refers to a corrected value for multiple tests (either Bonferroni Correction, or False Discovery Rate (FDR)), or an uncorrected p-value. A variant table is created as output (see figure 25.61), reporting only those variants with p-values lower than the threshold. All corrected and uncorrected p-values are shown here, so alternatively, variants with non-significant p-values can also be filtered out or more stringent thresholds can be applied at this stage, using the manual filtering options.

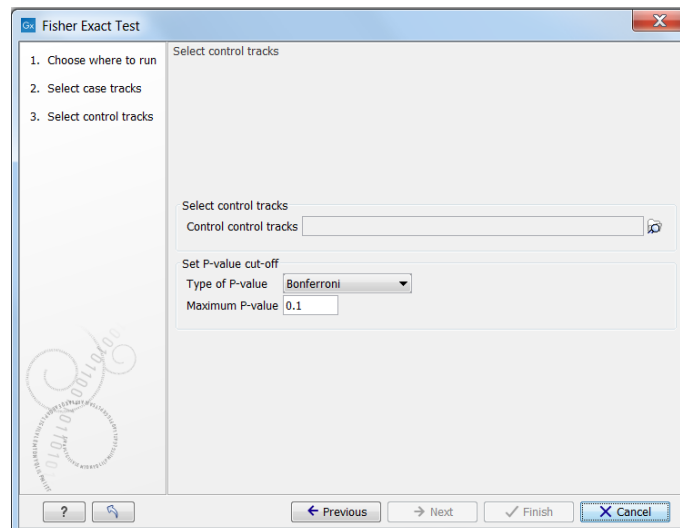

Figure 25.60: In this dialog you can select the control tracks, a p -value correction method, and specify the p -value threshold for the fisher exact test.

Chro...	Region	Type	Reference	Allele	Refere...	Length	Zygoty	Sample c...	Total num...	Sample fr...	P-value	Bonferroni	FDR p-val...
1	115247749~115247750	Insertion	-	A	No	1	Heterozygous	1	15	6.67	0.60	1.00	1.00
1	115247750	Deletion	A	-	No	1	Unknown	9	15	60.00	0.47	1.00	1.00
1	115248048	SNV	A	C	No	1	Heterozygous	1	15	6.67	0.85	1.00	1.00
1	115248053	SNV	C	T	No	1	Heterozygous	1	15	6.67	0.85	1.00	1.00
1	115248097	SNV	T	C	No	1	Heterozygous	1	15	6.67	0.60	1.00	1.00
1	115248251	Deletion	T	-	No	1	Heterozygous	1	10	10.00	1.00	1.00	1.00
1	115248260	SNV	G	A	No	1	Heterozygous	2	10	20.00	1.00	1.00	1.00
1	115248873	SNV	A	G	No	1	Heterozygous	4	15	25.67	0.54	1.00	1.00
1	115249240	Deletion	A	-	No	1	Heterozygous	13	15	86.67	1.49E-3	0.69	0.69
1	115250306	Deletion	A	-	No	1	Heterozygous	15	15	100.00	1.00	1.00	1.00
1	115259444	SNV	C	T	No	1	Heterozygous	1	10	10.00	1.00	1.00	1.00
1	226252135	SNV	A	T	No	1	Heterozygous	1	10	10.00	1.00	1.00	1.00
1	226253316	SNV	G	T	No	1	Homozygous	14	15	93.33	1.00	1.00	1.00
1	226259212	SNV	C	A	No	1	Heterozygous	1	15	6.67	0.60	1.00	1.00
1	226259212~226259213	Insertion	-	AA	No	2	Heterozygous	11	15	73.33	0.22	1.00	1.00
1	226259212~226259213	Insertion	-	A	No	1	Heterozygous	15	15	100.00	0.40	1.00	1.00
1	226259224~226259229	MNV	AAAAA	TTTTTT	No	6	Heterozygous	2	15	13.33	0.65	1.00	1.00
1	226259230	Deletion	T	-	No	1	Heterozygous	2	15	13.33	0.65	1.00	1.00
2	209101311	SNV	C	A	No	1	Unknown	15	15	100.00	1.00	1.00	1.00
2	209101907	Deletion	A	-	No	1	Heterozygous	15	15	100.00	1.00	1.00	1.00
2	209106897	SNV	A	G	No	1	Heterozygous	1	15	6.67	0.60	1.00	1.00
2	209108301	SNV	T	C	No	1	Heterozygous	1	15	6.67	0.60	1.00	1.00
2	209108317	SNV	C	T	No	1	Heterozygous	2	15	13.33	0.94	1.00	1.00
2	209110175~209110176	Insertion	-	A	No	1	Heterozygous	7	15	46.67	0.72	1.00	1.00
2	209110176	Deletion	A	-	No	1	Heterozygous	15	15	100.00	1.00	1.00	1.00
2	209113112	SNV	C	T	No	1	Heterozygous	1	15	6.67	0.85	1.00	1.00
2	209113192	SNV	G	A	No	1	Heterozygous	2	15	13.33	0.94	1.00	1.00
2	209116134	SNV	C	T	No	1	Heterozygous	1	15	6.67	0.60	1.00	1.00
3	41265953~41265954	Insertion	-	T	No	1	Homozygous	3	15	20.00	0.98	1.00	1.00
3	41265954	Deletion	T	-	No	1	Heterozygous	3	15	20.00	0.20	1.00	1.00
3	41266689	SNV	C	T	No	1	Heterozygous	1	15	6.67	0.85	1.00	1.00
3	41268677~41268678	Deletion	AT	-	No	2	Heterozygous	10	15	66.67	0.97	1.00	1.00
3	41281413	SNV	T	A	No	1	Unknown	13	15	86.67	0.30	1.00	1.00
3	41281477~41281478	Insertion	-	T	No	1	Heterozygous	3	15	20.00	0.94	1.00	1.00
3	41281477~41281478	Insertion	-	TT	No	2	Heterozygous	1	10	10.00	1.00	1.00	1.00
3	41281478	Deletion	T	-	No	1	Heterozygous	1	15	6.67	0.85	1.00	1.00
3	41281478~41281479	Deletion	TT	-	No	2	Heterozygous	2	10	20.00	1.00	1.00	1.00
3	41281478~41281480	Deletion	TTT	-	No	3	Heterozygous	2	10	20.00	1.00	1.00	1.00
3	41281478~41281481	Deletion	TTTT	-	No	4	Heterozygous	1	15	6.67	0.60	1.00	1.00
3	41281478~41281482	Deletion	TTTTTT	-	No	5	Heterozygous	1	15	6.67	0.60	1.00	1.00
3	41281478~41281484	Deletion	TTTTTTTT	-	No	7	Heterozygous	1	15	6.67	0.60	1.00	1.00
3	178866408	SNV	C	T	No	1	Unknown	2	15	13.33	0.65	1.00	1.00
3	178917005	SNV	A	G	No	1	Unknown	5	15	33.33	0.40	1.00	1.00
3	178917413	Deletion	A	-	No	1	Heterozygous	1	10	10.00	1.00	1.00	1.00

Figure 25.61: In the output table, you can view information about all significant variants, select which columns to view, and filter manually on certain criteria.

There are many other columns displaying information about the variants in the output table, such as the type, sequence, and length of the variant, its frequency and read count in case and control samples, and its overall zygosity. The zygosity information refers to **all** of the case samples; a label of 'homozygous' means the variant is homozygous in all case samples, a label of 'heterozygous' means the variant is heterozygous in all case samples, whereas a label of 'unknown' means it is heterozygous in some, and homozygous in others.

Overlapping variants: If two different types of variants occur in the same location, these are reported separately in the output table. This is particularly important, where SNPs occur in the

same position as an MNV. Usually, multiple SNVs occurring alongside each other would simply be reported as one MNV, but if one SNV of the MNV is found in additional case samples by itself, it will be reported separately. For example, if an MNV of AAT -> GCA at position 1 occurs in five of the case samples, and the SNV at position 1 of A -> G, occurs in an *additional* 3 samples (so 8 samples in total), the output table will list the MNV and SNV information separately (however, the SNV will be shown as being present in only 3 samples, as this is the number in which it appears 'alone').

The test will also check whether an SNV in the case group is part of an MNV in the control group.

25.15.4 Trio analysis

This tool should be used if you have a trio study with one child and its parents. It should be mainly used for investigating differences in the child in comparison to its parents.

To start the Trio analysis:

Toolbox | Resequencing (📁) | Compare Variants | Trio Analysis

In the first step of the dialog, select the variant track of the child. Clicking **Next** shows the dialog in figure 25.62.

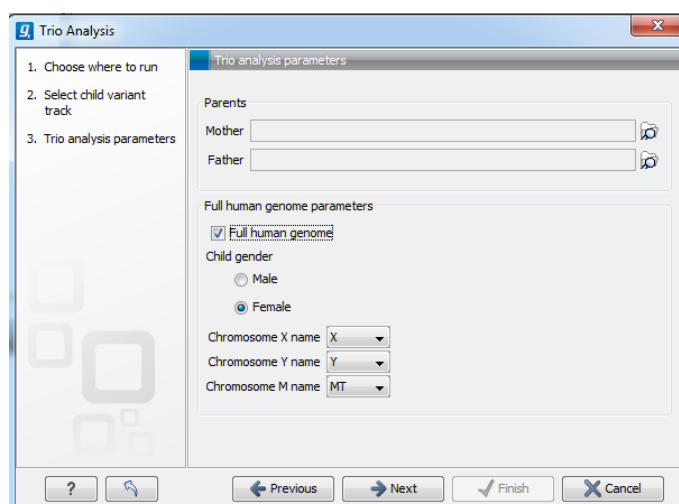

Figure 25.62: Selecting variant tracks of the parents.

Click on the folder (📁) to select the two variant tracks for the mother and the father. In case you have a human TRIO, please specify if the child is male or female and how the X, Y chromosomes as well as the mitochondrion are named in the genome track. These parameters are important in order to apply specific inheritance rules to these chromosomes.

Click **Next** and **Finish**.

The output is a variant track showing all variants detected in the child. For each variant in the child, it is reported whether the variant is inherited from the father, mother, both, either or is a de novo mutation. This information can be found in the tooltip for each variant or by switching to the table view (see the column labeled "Inheritance") (figure 25.63).

In cases where both parents are heterozygous with respect to a variant allele, and the child has the same phenotype as the parents, it is unclear which allele was inherited from which parent.

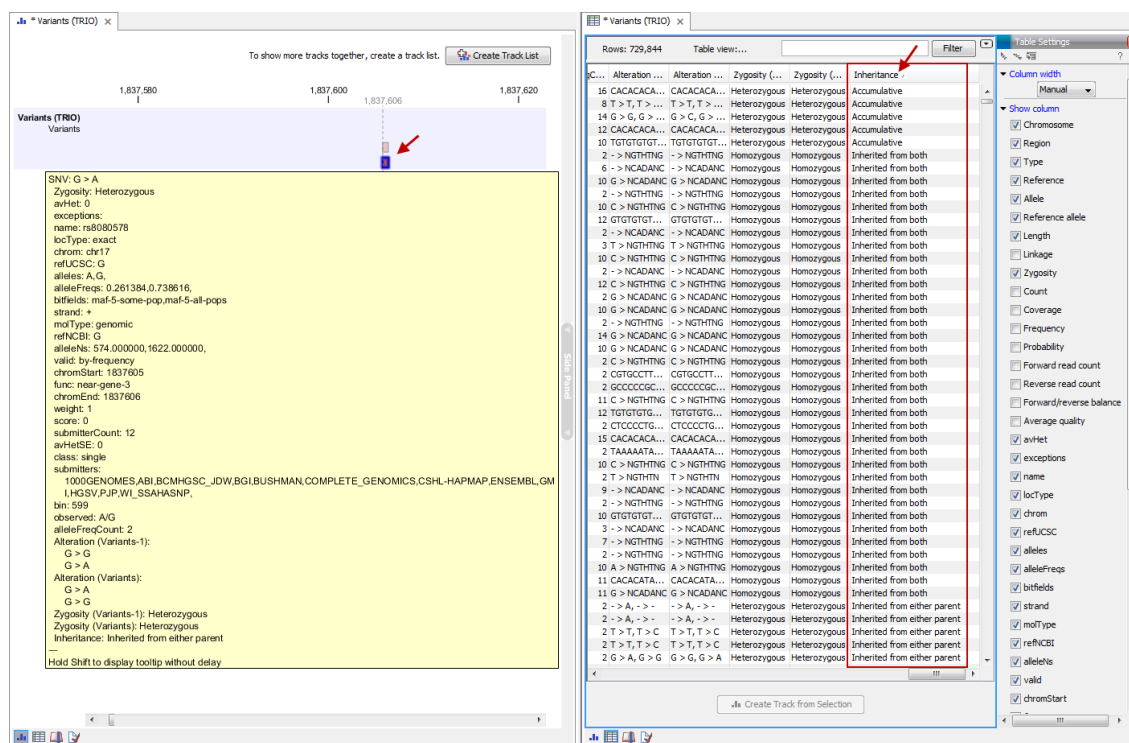

Figure 25.63: Output from Trio Analysis showing the variants found in the child in track and table format.

Such mutations are described as 'Inherited from either parent'.

In cases where both parents are homozygous with respect to a variant allele, and the child has the same phenotype as the parents, it is also unclear which allele was inherited from which parent. Such mutations are described as 'Inherited from both parents'.

In cases where both parents are heterozygous and the child homozygous for the variant, the child has inherited a variant from both parents. In such cases the tool will also check for a potential recessive mutation. Recessive mutations are present in a heterozygous state in each of the parents, but are homozygous in the child. To investigate potential disease relevant variants, recessive variants and de novo variants are the most interesting (in case the parents are not affected). The tool will also add information about the genotype (homozygote or heterozygote) in all samples.

For humans, special rules apply for chromosome X (in male children) and chromosome Y, as well as the mitochondrion, as these are haploid and always inherited from the same parent. Heterozygous variants in the child that do not follow mendelian inheritance patterns will be marked in the result.

Let's look at an example where these special rules apply - in this case the trio analysis is performed with a boy:

The boy has a position on the Y chromosome that is heterozygous for C/T. The heterozygous C is not present in neither the mother or father, but the T is present in the father. In this case the inheritance result for the T variant will be: 'Inherited from the father', and for the C variant 'de novo'. However, both variants will also be marked with 'Yes' in the column 'Mendelian inheritance problem' because of this aberrant situation. In case the child is female, all variants on the Y

chromosome will be marked in the same way.

The following annotations will be added to the resulting child track:

Zygosity Zygosity in the child as reported from the variant caller. Can be either homozygote or heterozygote.

Zygosity (Name of parent track 1) Zygosity in the corresponding parent (e.g. father) as reported from the variant caller. Can be either homozygote or heterozygote.

Allele variant (Name of parent track 1) Alleles called in the corresponding parent (e.g. father).

Zygosity (Name of parent track 2) Zygosity in the corresponding parent (e.g. mother) as reported from the variant caller. Can be either homozygote or heterozygote.

Allele variant (Name of parent track 2) Alleles called in the corresponding parent (e.g. mother).

Inheritance Inheritance status. Can be one of the following values, or a combination of these: 'De novo', 'Recessive', 'Inherited from both', 'Inherited from either', 'Inherited from (Name of parent track)'. For example, a proband homozygous for a variant that only one parent (the mother in this case) presents will result in an inheritance described as "De novo, inherited from mother".

Mendelian inheritance problem Variants not following the mendelian inheritance pattern are marked here with 'Yes'.

Note! If the variant at this position cannot be found in either of the parents, the zygosity status of the parent where the variant has not been found is unknown, and the allele variant column will be left empty.

25.15.5 Filter Against Control Reads

Running the variant caller on a case and control sample separately and filtering away variants found in the control data set does not always give a satisfactory result as many variants in the control sample have not been called. This is often due to lack of read coverage in the corresponding regions or too stringent parameter settings. Therefore, instead of calling variants in the control sample, the Filter Against Control Reads tool can be used to remove variants found in both samples from the set of candidate variants identified in the case sample.

Toolbox | Resequencing | Compare Variants | Filter against Control Reads

The variant track from the case sample must be used as input. When clicking **Next**, you are asked to supply the number of reads in the control data set that should support the variant allele in order to include it as a match (see figure 25.64). All the variants where at least this number of control reads show the particular allele will be filtered away in the result track.

Please note that variants, which have no coverage in the mapped control reads will be reported too. You can identify them by looking for a 0 value in the column 'Control coverage'.

The following annotations will be added to each variant not found in the control data set:

Control count For each allele the number of reads supporting the allele.

Control coverage Read coverage in the control dataset for the position in which the allele has been identified in the case dataset.

Control frequency Percentage of reads supporting the allele in the control sample.

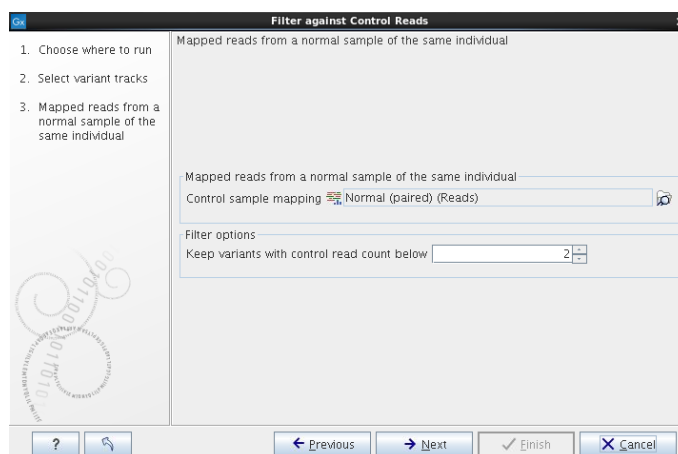

Figure 25.64: The control reads data set.

The filter option can be used to set a threshold for which variants should be kept. In the dialog shown in figure 25.64 the threshold is set at two. This means that if a variant is found in one or less of the control reads, it will be kept.

25.16 Predicting functional consequences

The tools for working with functional consequences all take a variant track as input and will predict or classify the functional impact of the variant.

25.16.1 Amino acid changes

This tool annotates variants with amino acid changes and creates a track for visual inspection of the amino acid changes. It takes a variant track as input and also requires a track with coding regions and a reference sequence.

To add information about amino acid changes to a variant track:

Toolbox | Resequencing Analysis (📁) | **Functional Consequences** (📁) | **Amino Acid Changes** (🌿)

If you are connected to a server, the first wizard step will ask you where you would like to run the analysis. Next, you must provide the variant track to be annotated with amino acid changes (see figure 25.65).

Click on the button labeled **Next** to go to the next wizard step (figure 25.66).

In this step you get the following options:

- **Select CDS track** Click on the folder icon (📁) in the right side of the wizard to select a CDS track. The CDS track is used to determine the reading frame and exon location to be used for translation. If you do not already have CDS, mRNA, and sequence tracks in

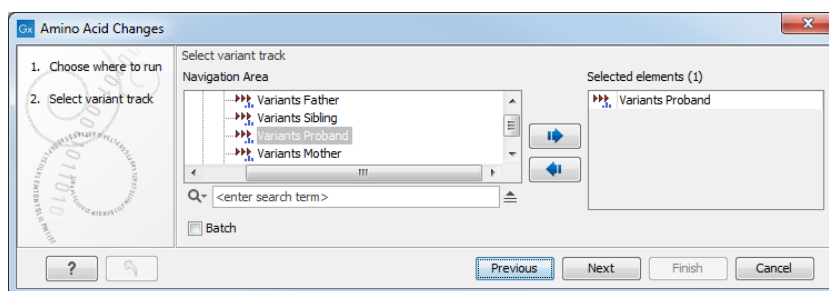

Figure 25.65: The amino acid changes annotation tool takes variant tracks as input.

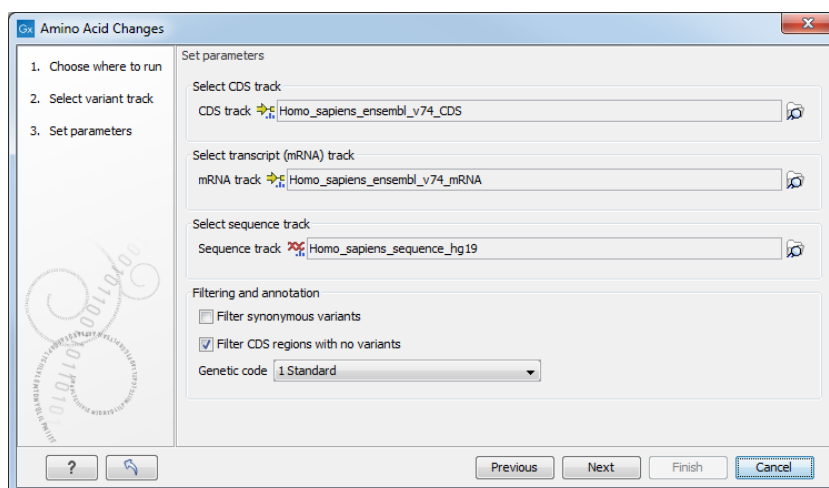

Figure 25.66: Select CDS, mRNA, and sequence track and choose whether or not you would like to filter away synonymous variants.

the Workbench, you can download it by clicking on the **Download** icon (📄) found in the upper right corner of the Workbench. Select **Download Reference Genome Data** (🌐) as described in section 7.1.

- **Select mRNA track** Click on the folder icon (📁) in the right side of the wizard to select the mRNA track. The mRNA track is used to determine whether the variant is inside or outside the region covered by the transcript. The mRNA track is optional. If you choose to provide an mRNA track you annotate variants that are located in the mRNA but also outside the region covering the coding sequence, in cases where such variants have been detected. If you choose not to provide an mRNA track, variants found outside the CDS region will not be annotated.
- **Select sequence track** Click on the folder icon (📁) in the right side of the wizard to select the reference sequence track.
- **Filtering and annotation**
 - The "Filter synonymous variants" option allows you to filter away synonymous variants that does not cause any change to the encoded amino acid.
 - By default, the tool will filter out CDS regions that have no variants. You can choose to include them in your amino acid annotation track by deselecting the "Filter CDS regions with no variants" option.
 - The genetic code is the code that is used for amino acid translation (see <http://www.ncbi.nlm.nih.gov/Taxonomy/Utils/wprintgc.cgi>). The default option is "1

standard", the vertebrate standard code. If relevant, you can use the drop-down list to change to the genetic code that applies to your organism.

Click on the button labeled **Next**, choose whether you would like to open or save the results and click on the button labeled **Finish**.

Two types of outputs are generated:

1. **A variant track** that has been annotated with the amino acid changes. The added information can be accessed via the tooltips in the variant track or in the extra columns that have been added to the variant table. The extra columns provide information about the amino acid changes (see <http://www.ncbi.nlm.nih.gov/Taxonomy/Utils/wprintgc.cgi>). The variant track opens in track view and the table view can be accessed by clicking on the table icon found in the lower left corner of the **View Area**.
2. **An amino acid track** that displays a graphical presentation of the amino acid changes. The track is based on the CDS track and in addition to the amino acid sequence of the coding sequence, all amino acids that have been affected by variants are shown as individual amino acids below the amino acid track. Changes causing a frameshift are symbolized with two arrow heads, and variants causing premature stop are marked with an asterisk. An example is shown in figure 25.67.

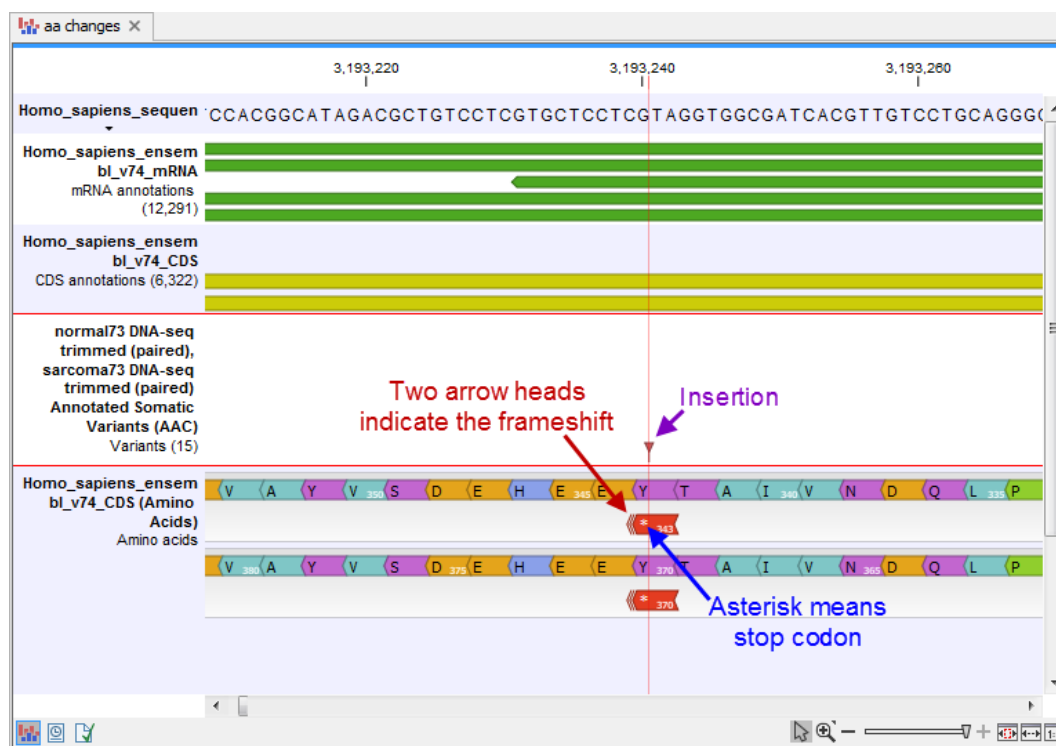

Figure 25.67: The variant track and the amino acid track is here presented together with the reference sequence and the mRNA and CDS tracks. An insertion (purple arrow) has caused a frameshift (red arrow) that has changed an alanine to a stop codon (blue arrow).

For each variant in the input track, the following information is added:

- **Coding region change.** This describes the relative position on the coding DNA level, using the nomenclature proposed at <http://www.hgvs.org/mutnomen/>. Variants inside

exons and in the untranslated regions of the transcript will also be annotated with the distance to the nearest exon. E.g. "c.-4A>C" describes a SNV four bases upstream of the start codon, while "c.*4A>C" describes a SNV four bases downstream of the stop codon.

- **Amino acid change.** This describes the change on the protein level. For example, single amino-acid changes caused by SNVs are listed as "p.[Gly261Cys]", denoting that in the protein sequence (hence the "p.") the Glycine at position 261 is changed into Cysteine. Frame-shifts caused by nucleotide insertions and deletions are listed with the extension *fs*, for example p.[Pro244fs] denoting a frameshift at position 244 coding for Proline. For further details of the nomenclature see the "Recommendations for the description of protein sequence variants (v2.0)" at <http://www.hgvs.org/mutnomen/>.
- **Coding region change in longest transcript.** When there are many transcript variants for a gene, the coding region change for all transcripts are listed in the "Coding region change" column. For quick reference, the longest transcript is often used, and there is a special column only listing the coding region change for the longest transcript.
- **Amino acid change in longest transcript.** This is similar to the above, just on the protein level.
- **Other variants within codon.** If there are other variants within the same codon, this column will have a "Yes". In this case, it should be manually investigated whether the two variants are linked by reads.
- **Non-synonymous.** Will have a "Yes" if the variant is non-synonymous at the protein level for any transcript. If the filter "Filter synonymous" was applied, this column will only contain entries labeled "Yes". A hyphen, "-", indicates the variant was present outside of a coding region.

An example of the output is given in figure 25.68.

The top track view displays a track list with the reference sequence, mRNA, CDS, variant, and amino acid tracks. The lower table view is the variant table that has been opened from the track list by double-clicking on the variant track name found in the left-hand side of the **View Area**. When opening the variant table in split view from the track list, the table and the variant track are linked.

An example illustrating a situation where different variants affect the same codon is shown in figure 25.69.

In this example three single nucleotide deletions are shown along with the resulting amino acid changes based on scenarios where only one deletion is present at the time. The first affected amino acid is shown for each of the three deletions. As the first deletion affect the encoded amino acid, this amino acid change is shown with a four nucleotide long arrow (that includes the deletion). The other two deletions do not affect the encoded amino acid as the frameshift was "synonymous" at the position encoded by the codon where the deletion was introduced. The effect is first seen at the next amino acid position (763 and 764, respectively), which does not contain a deletion, and therefore is illustrated with a three nucleotide long arrow.

The hash symbol (#) on the changed amino acids symbolize that more than one variant can be present in the region encoding this specific amino acid. The simultaneous presence of multiple variants within the same codon is not predicted by the amino acid changes tool. Manual inspection of the reads is required to be able to detect multiple variants within one codon.

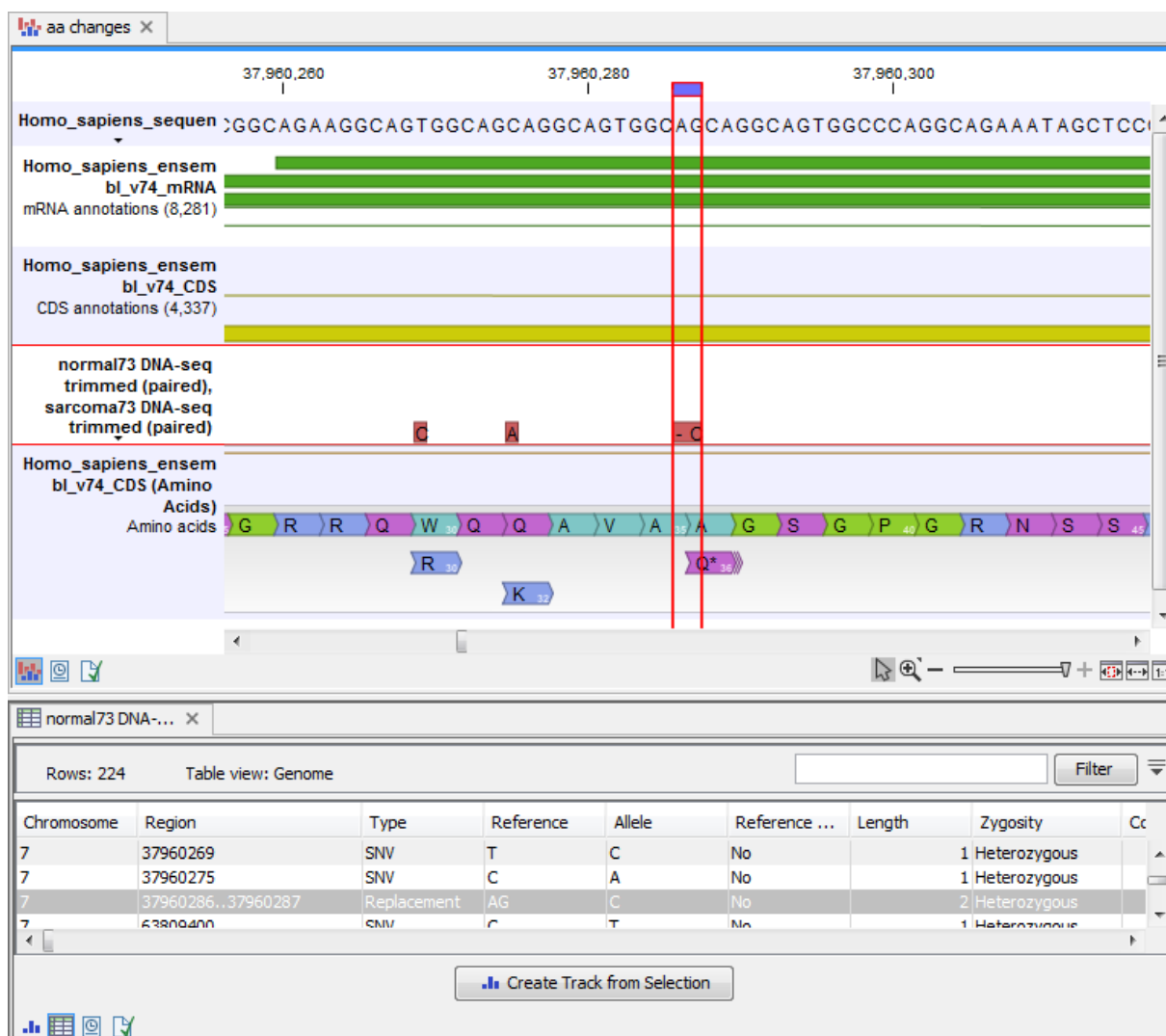

Figure 25.68: The resulting amino acid changes in track and table views. When the variant table has been opened by double-clicking on the text found in the left side of the View Area, the variant table and the variant track are linked. When clicking on an entry in the table, this position will be brought into focus in the variant track.

The amino acid track

The colors of the amino acids in the amino acid track can be changed in the **Side Panel** under **Track layout** and "Amino acids track" (see figure 25.70).

Four different color schemes are available under "Amino acid colors":

- **Gray** All amino acids are shown in gray.
- **Group** Colors the amino acids in groups by the following properties:
 - **Purple** neutral, polar
 - **Turquoise** neutral, nonpolar
 - **Orange** acidic, polar
 - **Blue** basic ,polar

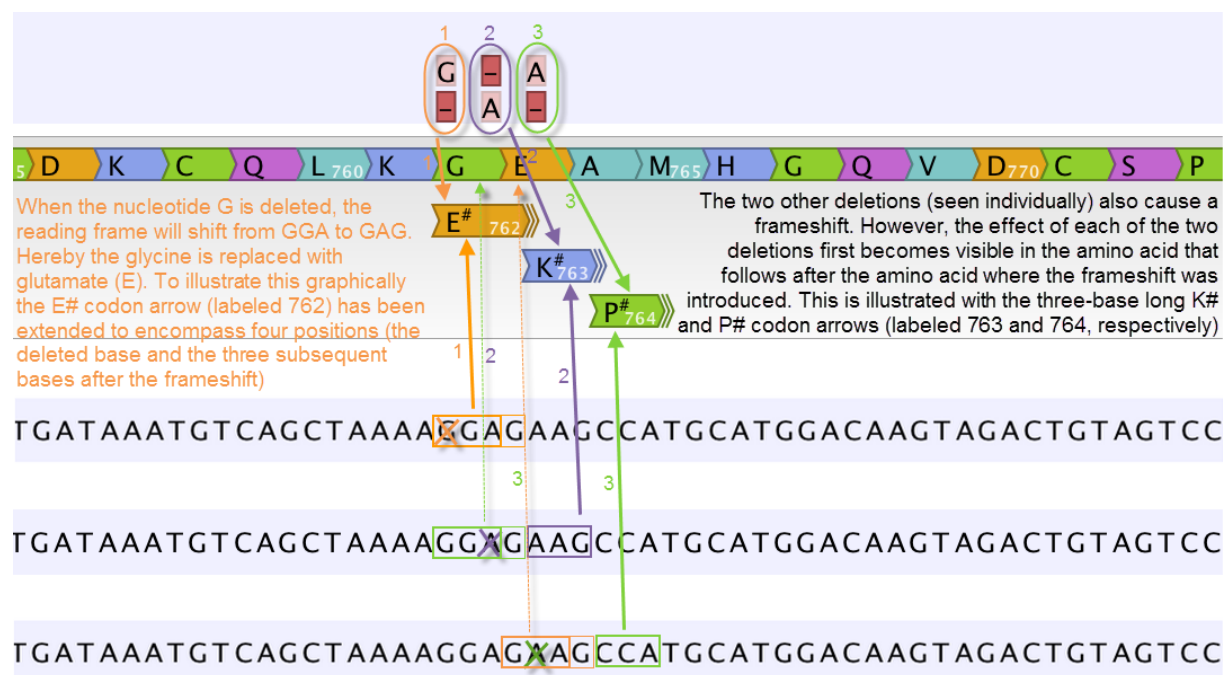

Figure 25.69: Amino acids encoded from codons that potentially could have been affected by more than one variant are marked with a hash symbol (#) as the graphically presented amino acid changes always only include a single variant (a SNV, MNV, insertion, or deletion). Shown here are three different variants, present only one at the time, and the consequences of the three individual deletions. In cases where the deletion is found in a codon that is affected with an amino acid change, the arrow also include the deletion (situation 1) in the two other scenarios, the codon containing the deletion is changed to a codon that encodes the same amino acid, and the effect is therefore not seen until in the subsequent amino acid.

- **Bright green** other (functional properties)
- **Polarity** Colors the amino acids according to the following categories:
 - **Green** neutral, polar
 - **Black** neutral, nonpolar
 - **Red** acidic, polar
 - **Blue** basic ,polar
- **Rasmol** Colors the amino acids according to the Rasmol color scheme (see <http://www.openrasmol.org/doc/rasmol.html>).

25.16.2 Predict splice site effect

This tool will analyze a variant track to determine whether the variants fall within potential splice sites. First select your variant track (figure 25.71) followed by a transcript track (see figure 25.72). As part of the dialog you can choose to exclude all variants that do not fall within a splice site.

If a variant falls within two base pairs of an intron-exon boundary, it will be annotated as a possible splice site disruption (see figure 25.73).

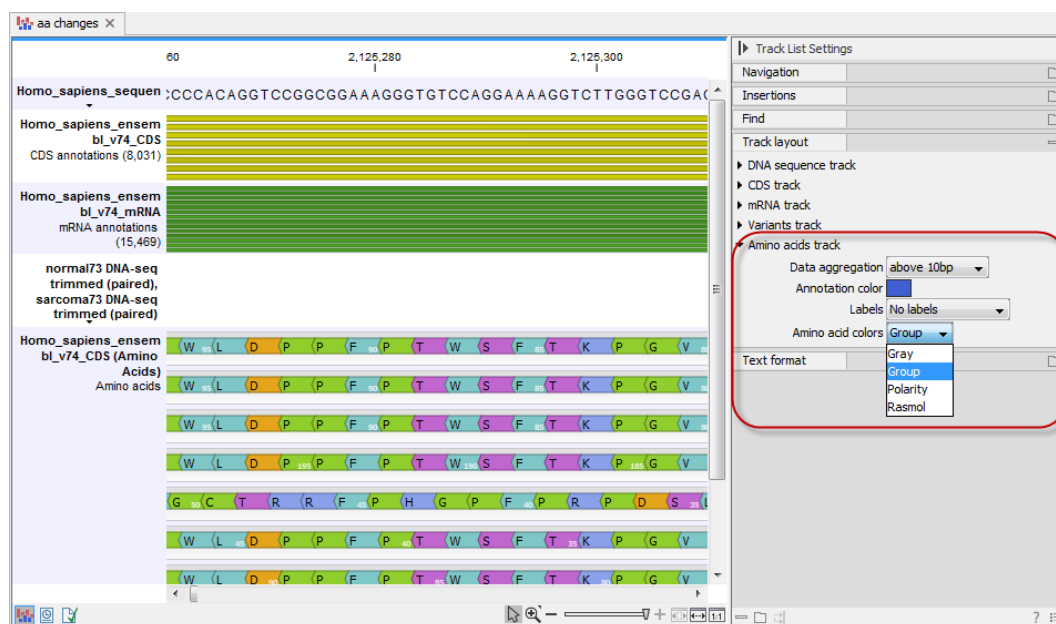

Figure 25.70: The colors of the amino acids can be changed in the Side Panel under "Amino acids track".

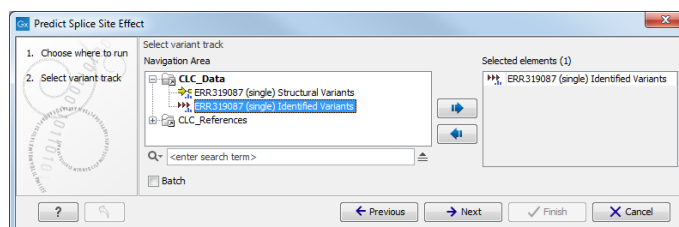

Figure 25.71: Variant track selection.

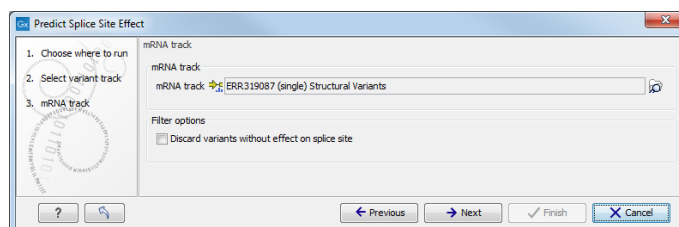

Figure 25.72: Transcript track selection.

25.16.3 GO enrichment analysis

This tool can be used to investigate candidate variants or better their corresponding altered genes for a common functional role. For example if you would like to know what is interesting in the zebu cattle in comparison to bison and taurine cattle, you can use this tool. For that approach, first filter all found variants in zebu for zebu-specific variants and afterwards run the GO enrichment test for biological process to see that more variants than expected are in immune response genes. These can then be further investigated.

For this, you need a GO association file, which includes gene names and associated Gene Ontology terms. You can download that from the Gene Ontology web site for different species (<http://www.geneontology.org/GO.downloads.annotations.shtml>). Find *Bos taurus* on the list and double-click on "annotations" (see figure 25.74). Import the downloaded annotations into the *CLC Genomics Workbench* using "Standard Import".

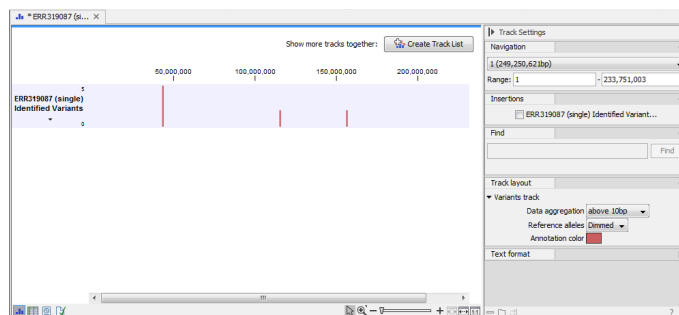

Figure 25.73: Results of the predict splice site effect tool.

Filtered Annotation File Downloads

Species, Database	Gene Products Annotated	Annotations	Submission date MM/DD/YYYY	Download filtered files
<i>Agrobacterium tumefaciens</i> str. C58 PAMGO	82	248 (248 non-IEA)	9/24/2012	annotations [3.5 kb] README
<i>Arabidopsis thaliana</i> TAIR	30325	180071 (180071 non-IEA)	12/6/2013	annotations [6.1 mb] README
<i>Aspergillus nidulans</i> AspGD	47595	219260 (83897 non-IEA)	1/5/2014	annotations [2.5 mb] README
Comprehensive Microbial Resource [multispecies] JCVI	61680	154223 (154223 non-IEA)	11/1/2013	annotations [1.8 mb] README
<i>Bos taurus</i> GO Annotations @ EBI	19674	111567 (16019 non-IEA)	12/11/2013	annotations [1.5 mb] README
<i>Caenorhabditis elegans</i> WormBase	18968	129996 (67295 non-IEA)	12/6/2013	annotations [1.7 mb] README
<i>Candida albicans</i> CGD	22795	151635 (27168 non-IEA)	1/5/2014	annotations [1.9 mb] README

Figure 25.74: Download the GO Annotations from *Bos taurus* by double-clicking on "annotations" and import the downloaded annotations into the **CLC Genomics Workbench** using "Standard Import".

To run the analysis go to the toolbox:

Toolbox | Resequencing Analysis (📊) | Functional Consequences | GO Enrichment Analysis

When you run the GO Enrichment Analysis, you have to specify both the annotation association file, a gene track and finally which ontology (cellular component, biological process or molecular function) you would like to test for (see figure 25.75).

The analysis starts by associating all of the variants from the input variant file with genes in the gene track, based on overlap with the gene annotations. A variant track can be created with the *CLC Genomics Workbench* (variant callers as in section 25.4 or 25.2).

Next, the Workbench tries to match gene names from the gene (annotation) track with the gene names in the GO association file. A gene (annotation) track can be created (see section 23.4.1). Please be aware that the same gene name definition should be used in both files.

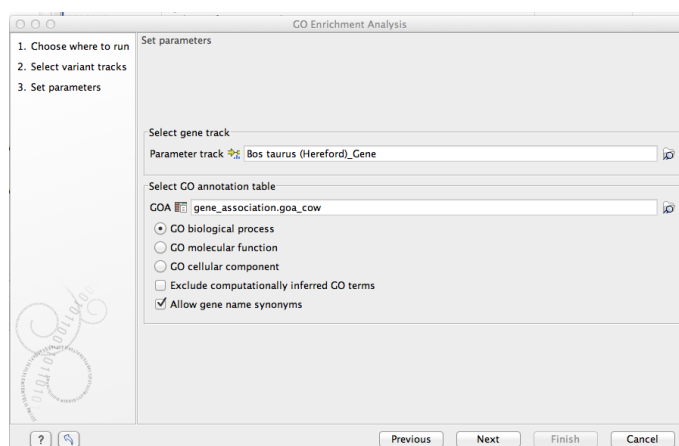

Figure 25.75: The GO enrichment settings.

Based on this, the Workbench finds GO terms that are over-represented in the list. A hypergeometric test is used to identify over-represented GO terms by testing whether some of the GO terms are over-represented in a given gene set, compared to a randomly selected set of genes.

The result is a table with GO terms and the calculated p-value for the candidate variants, and a new variant file with annotated GO terms and the corresponding p-value (see figure 25.76). The p-value is the probability of obtaining a test statistic at least as extreme as the one that was actually observed, or in other words how significant (trustworthy) a result is. In case of a small p-value the probability of achieving the same result by chance with the same test statistic is very small.

25.16.4 Conservation score annotation

The possible functional consequence of a variant can be interrogated by comparing to a conservation score that tells how conserved this particular position is among a set of different species. The underlying line of thought is that conserved bases are functionally important - otherwise they would have been mutated during evolution. If a variant is found at a position that is otherwise well conserved, it is an indication that the variant is functionally important. Of course this is only a prediction, as non-conserved regions could have functional roles too.

Conservation scores can be computed by several tools e.g. PhyloP and PhastCons and can be downloaded as pre-computed scores from a whole genome alignment of different species from different sources. See how to find and import tracks with conservation scores in section 6.2.

Toolbox | Resequencing | Functional Consequences | Annotate with Conservation Score

Select the variant track as input and when you click **Next** you will need to provide the track with conservation scores (see figure 25.77).

In the resulting track, all the variants will have quality scores annotated, and this can be used for sorting and filtering the track (see section 23.1.3).

25.16.5 Link Variants to 3D Protein Structure

This tool makes it possible to visualize variant consequences on 3D protein structures. It takes a variant track as input, and produces a new variant track as output, with two additional columns in the table view:

GO term	Description	Occurrences in all g...	Occurrences in sample	P-values
0002755	MyD88-dependent toll-like receptor signaling pathway	6	4	2.38E-6
0032755	positive regulation of interleukin-6 production	22	6	3.64E-6
0032757	positive regulation of interleukin-8 production	13	5	3.66E-6
0034123	positive regulation of toll-like receptor signaling pathway	4	3	3.23E-5
0042346	positive regulation of NF-kappaB import into nucleus	14	4	1.40E-4
0007252	I-kappaB phosphorylation	6	3	1.57E-4
0032722	positive regulation of chemokine production	7	3	2.70E-4
0050707	regulation of cytokine secretion	7	3	2.70E-4
0071224	cellular response to peptidoglycan	2	2	4.09E-4
0050729	positive regulation of inflammatory response	19	4	4.99E-4
0044130	negative regulation of growth of symbiont in host	11	3	1.20E-3
0002830	positive regulation of type 2 immune response	3	2	1.21E-3
0045356	positive regulation of interferon-alpha biosynthetic process	3	2	1.21E-3
0042773	ATP synthesis coupled electron transport	4	2	2.39E-3
0048016	inositol phosphate-mediated signaling	4	2	2.39E-3
0050766	positive regulation of phagocytosis	14	3	2.53E-3
0071260	cellular response to mechanical stimulus	30	4	2.97E-3
0001867	complement activation, lectin pathway	5	2	3.93E-3
0002024	diet induced thermogenesis	5	2	3.93E-3
0042116	macrophage activation	5	2	3.93E-3
0045080	positive regulation of chemokine biosynthetic process	5	2	3.93E-3
0045359	positive regulation of interferon-beta biosynthetic process	5	2	3.93E-3
0006955	immune response	101	7	4.35E-3
0051092	positive regulation of NF-kappaB transcription factor activity	55	5	4.97E-3
0002925	positive regulation of humoral immune response mediated by circulating immunog...	6	2	5.82E-3
0006120	mitochondrial electron transport, NADH to ubiquinone	6	2	5.82E-3
0051607	defense response to virus	58	5	6.24E-3
0019221	cytokine-mediated signaling pathway	19	3	6.26E-3
0032760	positive regulation of tumor necrosis factor production	19	3	6.26E-3
0050830	defense response to Gram-positive bacterium	19	3	6.26E-3
0006954	inflammatory response	86	6	7.88E-3
0002504	antigen processing and presentation of peptide or polysaccharide antigen via MH...	7	2	8.04E-3
0045078	positive regulation of interferon-gamma biosynthetic process	7	2	8.04E-3
0048246	macrophage chemotaxis	7	2	8.04E-3
0050718	positive regulation of interleukin-1 beta secretion	7	2	8.04E-3
0050730	regulation of peptidyl-tyrosine phosphorylation	7	2	8.04E-3
0006465	signal peptide processing	8	2	0.01
0008306	associative learning	8	2	0.01
0003214	cardiac left ventricle morphogenesis	9	2	0.01
0007338	single fertilization	9	2	0.01
0018149	peptide cross-linking	9	2	0.01
0051894	positive regulation of focal adhesion assembly	9	2	0.01
0008203	cholesterol metabolic process	25	3	0.01
0021987	cerebral cortex development	25	3	0.01
0032695	negative regulation of interleukin-12 production	10	2	0.02
0033198	response to ATP	10	2	0.02
0030198	extracellular matrix organization	51	4	0.02
0042523	positive regulation of tyrosine phosphorylation of Stat5 protein	11	2	0.02
0048013	ephrin receptor signaling pathway	11	2	0.02
0002023	reduction of food intake in response to dietary excess	1	1	0.02
0002238	response to molecule of fungal origin	1	1	0.02
0002369	T cell cytokine production	1	1	0.02

Figure 25.76: The results of the analysis.

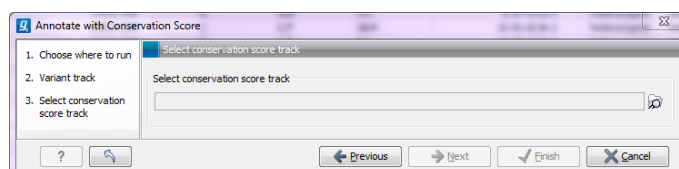

Figure 25.77: The conservation score track.

- Link to 3D protein structure:** If a variant affects the amino acid composition of a protein, and a 3D structure of sufficient homology can be found in the Protein Data Bank (PDB), a link is provided in this column. Via the link, the structure can be downloaded and a 3D model and visualization of the variant consequences on the protein structure will be created.
- Effect on drug binding site:** If any of the homologous structures found in PDB has a drug or ligand in contact with the amino acid variation, a link is provided in this column. Via the link, a list of drug hits can be inspected. The list has links for creating 3D models and visualizations of the variant-drug interaction.

In section 25.16.2 it is described how to interpret the output in the variant table and how the tool finds appropriate protein structures to use for the visualizations, and in section 25.16.2 and onwards it is described how the 3D models and visualizations are created.

Note: Before running the tool, a protein structure sequence database must be downloaded and installed using the **Download 3D Protein Structure Database** tool (see section 25.16.6).

To run the tool, select:

Toolbox | Resequencing Analysis (📁) | **Functional Consequences** (📁) | **Link Variants to 3D Protein Structure** (🔗)

If you are connected to a server, you will first be asked where you want to run the analysis. In the next wizard step you will be asked for an input file. The **Link Variants to 3D Protein Structure** accepts variant tracks as input (see figure 25.78).

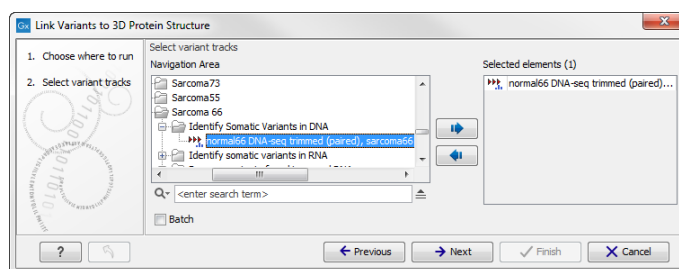

Figure 25.78: Select the variant track holding the variants that you would like to visualize on 3D protein structures.

Click on the button labeled **Next**. In the next wizard step, you must provide a CDS track and the reference sequence track (figure 25.79).

If you have not already downloaded a CDS and a reference sequence track, this can be done in the upper right corner of the Workbench by clicking on the button labeled **Download** and choosing **Download Reference Genome Data** (🌐) (see section 7.1).

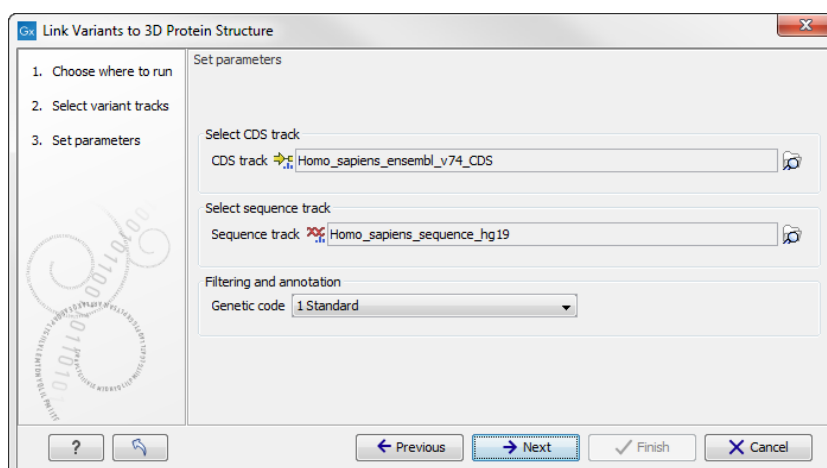

Figure 25.79: Select CDS and reference sequence.

Click on the button labeled **Next**, choose where you would like to save the data, and click on the button labeled **Finish**.

As output, the tool produces a new variant track, with two additional columns in the table view ('Link to 3D protein structure' and 'Effect on drug binding site' - figure 25.80). The default output view is the variant track. To shift to table view, click on the table icon found in the lower left corner of the View Area.

pt	Coding region change in longest transcript	Non-synonymous	Link to 3D protein structure	Effect on drug binding site
	NP_214517.1:c.167C>T	Yes	recF Ala56Val	No drug hits (recF Ala56Val)
	NP_214517.1:c.175C>T	Yes	recF Pro59Ser	No drug hits (recF Pro59Ser)
	NP_214517.1:c.734T>C	Yes	recF (no PDB hits)	recF (no PDB hits)
	NP_214520.1:c.616G>C	Yes	gyrA Glu21Gln	No drug hits (gyrA Glu21Gln)
	NP_214520.1:c.284G>C	Yes	gyrA Ser95Thr	1 drug hit (gyrA Ser95Thr)
	NP_214520.1:c.2083G>A	Yes	gyrA Gly668Asp	No drug hits (gyrA Gly668Asp)
	NP_214522.1:c.433T>C	Yes	Rv008c (no PDB hits)	Rv008c (no PDB hits)
	NP_214526.1:c.697T>C	Yes	Rv0012 (no PDB hits)	Rv0012 (no PDB hits)
	YP_177615.1:c.204C>G	Yes	trpG Ile68Met	No drug hits (trpG Ile68Met)
	NP_214528.1:c.1703G>A	Yes	plnB Gly568Asp	No drug hits (plnB Gly568Asp)
	NP_214532.1:c.1387C>T	Yes	psfP (no PDB hits)	psfP (no PDB hits)
	NP_214534.1:c.723_724delACinsGG	Yes	fhaA (no PDB hits)	fhaA (no PDB hits)
	NP_214534.1:c.720G>C	Yes	fhaA (no PDB hits)	fhaA (no PDB hits)
	NP_214535.1:c.134delG	Yes	Rv0021c (frame shift)	Rv0021c (frame shift)

Figure 25.80: The variant table output.

The variant table output

For each variant in the input, the Link Variants to 3D Protein Structure tool does the following, to prepare output for the "Link to 3D protein structure" and "Effect on drug binding site" columns in the output variant track:

1. Evaluate if the variant is found inside a CDS region. Otherwise the following is returned for the variant: **(outside CDS regions)**.
2. If the variant is in a CDS region, translate the reference sequence of the impacted gene into an amino acid sequence and evaluate if the variant can be expected to have an effect on protein structure that can be visualized. Overlapping genes (common in prokaryotic genomes) with different reading frames may cover a given variation, in which case multiple protein sequences will be considered.

For variants that cannot be visualized, the gene name and one of the reasons given below will be listed in the output table:

- **(nonsense)** - the variant would result in a stop codon being introduced in the protein sequence.
 - **(synonymous)** - the variant would not change the amino acid.
 - **(frame shift)** - the variant would introduce a frame shift.
3. BLAST the translated amino acid sequence (the query sequence) against the protein structure sequence database (see section 25.16.6) to identify structural candidates. Note that if multiple splicing variants exist, the protein structure search is based on the longest splicing variant. BLAST hits with E-value > 0.0001 are rejected and a maximum of 2500 BLAST hits are retrieved. If no hits are obtained, the gene name and the message **(no PDB hits)** are listed.
 4. For each BLAST hit, check if the variant is covered by the structure. For a variant resulting in one amino acid being replaced by another, the affected amino acid position should be present on the structure. For a variant resulting in amino acid insertions or deletions, the amino acids on both sides of the insertion/deletion must be present on the structure.
 5. For the BLAST hits covering the variant, rank the structures considering both structure quality and homology (see section 25.16.2).
 6. Add the gene name and the description of the amino acid change to the "Link variant to 3D protein structure" column in the output variant track. A link on the description gives access to a 3D view of the variant effect using the best ranked protein structure from point 5 (see section 25.16.2). Note that the amino acid numbering is based on the longest CDS annotation found.

7. Extract all BLAST hits from point 5, where the affected amino acid(s) are in contact with a drug or ligand in the PDB file (heavy atoms within 5 Å). If no structures with variant-drug interaction are found, the following is returned to the "Effect on drug binding site" column: **No drug hits** together with the gene name and the description of the amino acid change. If structures with variant-drug interaction are found, the number of different drugs or ligands encountered are written to the "Effect on drug binding site" column as **X drug hits**. From a link on "X drug hits", a list describing the drug hits in more detail can be opened. The list also has a link for each drug, to create a 3D model and visualization of the variant-drug interaction section [25.16.2](#).

Create 3D visualization of variant

Clicking a link provided in the 'Link to 3D Protein Structure' column will show a menu with three options:

- 'Download and Show Structure' will open a 3D view visualizing the consequences of the variant on a protein structure (figure [25.80](#)).
- 'Download and Show All Variants (x) on Structure' will open a 3D view visualizing the consequences of x variants on the same protein structure (figure [25.81](#)).

Note 1: Only variants shown in the table will be included in the view (e.g. variants filtered out will be ignored).

Note 2: It is not always possible to visualize variants on the same gene together on the same structure, since many structures in the PDB only cover parts of the whole protein.

Note 3: Even though variants may be possible to visualize together, it does not necessarily mean they occur together on the same protein. For example, in diploid cells, heterozygous variants may not.

- 'Help' gives access to this documentation.

The "Download and Show.... " options will do the following:

1. **Download and import** the PDB file containing the protein structure for the variant (found by the 'Link Variants to 3D Protein Structure' tool - section [25.16.2](#)).
2. **Generate biomolecule** involving the modeled chain, if the information is available in the PDB file (see Infobox below).
3. **Create an alignment** between the reference protein sequence for the gene impacted by the variant (the query sequence) and the sequence from the protein structure (the template structure).
4. **Create a model structure for the reference** by mapping it onto the template structure based on the sequence alignment (see section [25.16.2](#)).
5. **Create a model structure with variant(s)** by mapping the protein sequence with the variant consequences onto the reference structure model (see section [25.16.2](#)).

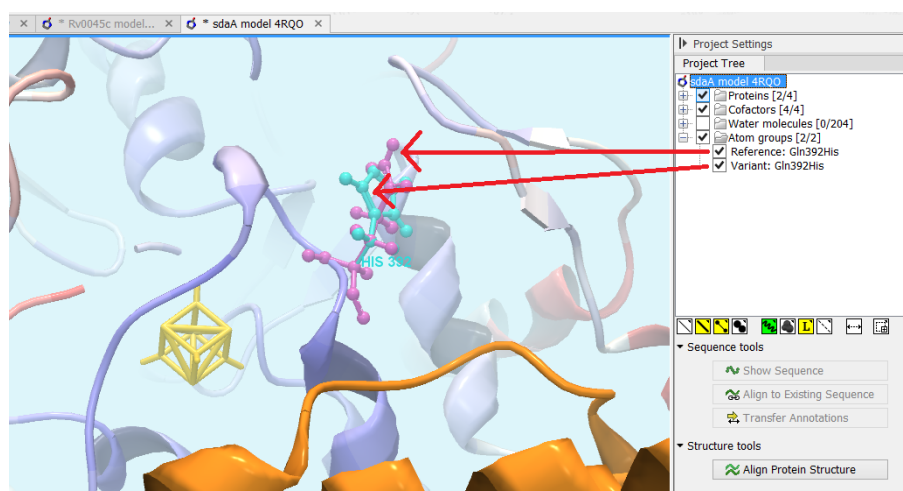

Figure 25.81: Generated 3D view of variant. The reference amino acid is seen in purple and the variant in cyan on top of each other. Only the backbone of protein structures are visualized by default. The modeled protein structure is colored to indicate local model uncertainty - red for flexible and uncertain parts of the structure model and blue for very well defined and accurate parts of the structure model. Other molecules from the PDB file are colored orange or yellow.

6. **Open a 3D view** (a Molecule Project) with the variant structure model shown in backbone representation. The model is colored by temperature (see figure 25.81), to indicate local model uncertainty (see section 25.16.2). The consequence(s) of the variant(s) are highlighted by showing involved amino acids in ball n' sticks representation with the reference colored purple and the variant cyan. Other molecules from the PDB file are shown in orange or yellow coloring (figure 25.81).

From the Project Tree in the Side Panel of the Molecule Project, the category 'Atom groups' contains two entries for each variant shown on the structure - one entry for the reference and one for the variant (figure 25.81). The atom groups contain the visualization of the variant consequence on structure. For variants resulting in amino acid replacements, the affected amino acid is visualized. For variants resulting in amino acid insertions or deletions, the amino acids on each side of the deletion/insertion are visualized.

The template structure is also available from the Proteins category in the Project Tree, but hidden in the initial view. The initial view settings are saved on the Molecule Project as "Initial visualization", and can always be reapplied from the View Settings menu (☰) found in the bottom right corner of the Molecule Project (see section 4.6).

Tip: Double-click an entry in the Project Tree to zoom the 3D view to the atoms.

You can save the 3D view (Molecule Project) in the Navigation Area for later inspection and analysis. Read more about how to customize visualization of molecules in section 12.3.

Infobox: Biomolecules in CLC Genomics Workbench

Protein structures imported from a PDB file show the tertiary structure of proteins, but not necessarily the biologically relevant form (the quaternary structure). Oftentimes, several copies of a protein chain need to arrange in a multi-subunit complex to form a functioning biomolecule. In some PDB files several copies of a biomolecule are present and in others only one chain from a multi-subunit complex is present. In many cases, PDB files have information about how the molecule structures in the file can form biomolecules. In *CLC Genomics Workbench* variants are therefore shown in a protein structure context representing a functioning biomolecule, if this information is available in the selected template PDB file.

Visualize drug interaction

Clicking a link provided in the 'Drug interaction in protein 3D structure' column will open a list with information about the drug hits (figure 25.82).

PDB hit	Drug name	DrugBank info	Organism	Description
2Y3P	SIMOCYCLINONE D8		ESCHERICHIA COLI	CRYSTAL STRUCTURE OF N-TERMINAL DOMAIN OF GYRA WITH THE ANTIBIOTIC SIMOCYCLINO
4KPE			STREPTOCOCCUS PNEUMONIAE	NOVEL FLUOROQUINOLONES IN COMPLEX WITH TOPOISOMERASE IV FROM S. PNEUMONIAE AN
3E0E	MOXIFLOXACIN (AVELOX)	DB00218	STREPTOCOCCUS PNEUMONIAE	STRUCTURAL INSIGHT INTO THE QUINOLONE-DNA CLEAVAGE COMPLEX OF TYPE IIA TOPOISON
3E0E	CLINIFLOXACIN		STREPTOCOCCUS PNEUMONIAE	STRUCTURAL INSIGHT INTO THE QUINOLONE-DNA CLEAVAGE COMPLEX OF TYPE IIA TOPOISON
3OX3	ETOPOSIDE (EPOSI)	DB00273	HOMO SAPIENS	HUMAN TOPOISOMERASE IIBETA IN COMPLEX WITH DNA AND ETOPOSIDE
4G0V	MITOXANTRONE (MITOX)	DB01204	HOMO SAPIENS	HUMAN TOPOISOMERASE IIBETA IN COMPLEX WITH DNA AND MITOXANTRONE
4G0W	AMETANTRONE		HOMO SAPIENS	HUMAN TOPOISOMERASE IIBETA IN COMPLEX WITH DNA AND AMETANTRONE

Figure 25.82: An example of a drug hit table with information about the drug and with links to 3D visualizations of variant-drug interaction.

The information available in the drug hit list is the following:

- **PDB hit.** Clicking a link provided in the PDB hit column will show a menu with two options: "Download and Show Structure" and "Help". "Help" gives access to this documentation. The "Download and Show Structure" option does exactly as described in section 25.16.2, except that the final 3D visualization is centered on the drug, and the drug is shown in ball n' sticks representation with atoms colored according to their atom types (figure 25.83).
- **PDB drug name.** (Hidden by default) The identifier used by PDB for the ligand or drug.
- **Drug name.** When possible, a common name for the potential drug is listed here. The name is taken from the corresponding DrugBank entry (if available) or from the PDB header information for the PDB hit.
- **DrugBank info.** If information about the drug or ligand is available in DrugBank (www.drugbank.ca [Law et al., 2014, Wishart et al., 2006]), a weblink to the appropriate site is listed here.
- **E-value.** (Hidden by default) The E-value is a measure of the quality of the match returned from the BLAST search. The closer to zero, the more homologous is the template structure to the query sequence.
- **Organism.** (Hidden by default) The organism for which the PDB structure has been obtained.
- **Description.** The description of the PDB file content, as given in the header of the PDB hit.

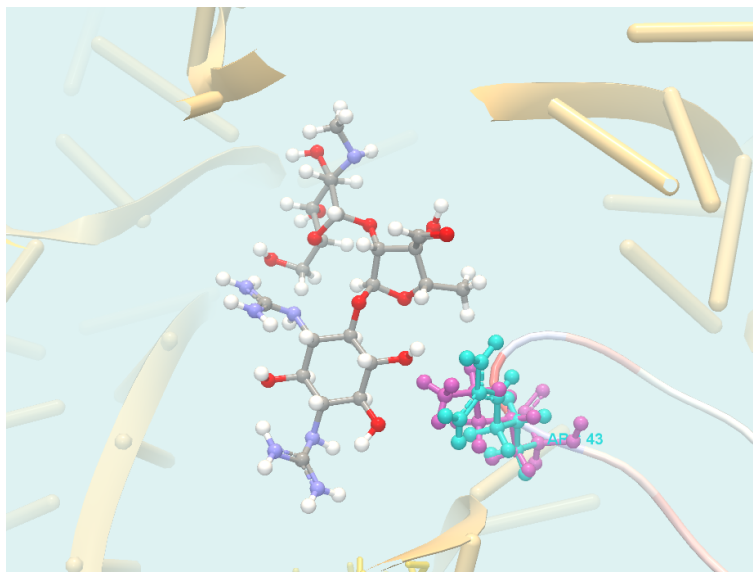

Figure 25.83: 3D visualization of variant-drug interaction. The drug (streptomycin) is in center of the view, and colored according to its atom types. The variant is visualized as in figure 25.81. In this picture, the foreground has been cut away using the clipping plane functionality found in the Visualization tab in the Side Panel, to better see the variant-drug interaction.

Protein coloring to visualize local structural uncertainties

The default coloring scheme for modeled structures in *CLC Genomics Workbench* is "Color by Temperature". This coloring indicates the uncertainty or disorder of each atom position in the structure.

For crystal structures, the temperature factor (also called the B-factor) is given in the PDB file as a measure of the uncertainty or disorder of each atom position. The temperature factor has the unit \AA^2 , and is typically in the range [0, 100].

The temperature color scale ranges from blue (0) over white (50) to red (100) (see section 12.3.1).

For structure models created in *CLC Genomics Workbench*, the temperature factor assigned to each atom combines three sources of positional uncertainty:

- **PDB Temp.** The atom position uncertainty for the template structure, represented by the temperature factor of the backbone atoms in the template structure.
- **P(alignment)** The probability that the alignment of a residue in the query sequence to a particular position on the structure is correct.
- **Clash?** It is evaluated if atoms in the structure model seem to clash, thereby indicating a problem with the model.

The three aspects are combined to give a temperature value between zero and 100, as illustrated in figure 25.84 and 25.85.

When holding the mouse over an atom, the Property Viewer in the Side Panel will show various information about the atom. For atoms in structure models, the contributions to the assigned temperature are listed as seen in figure 25.86.

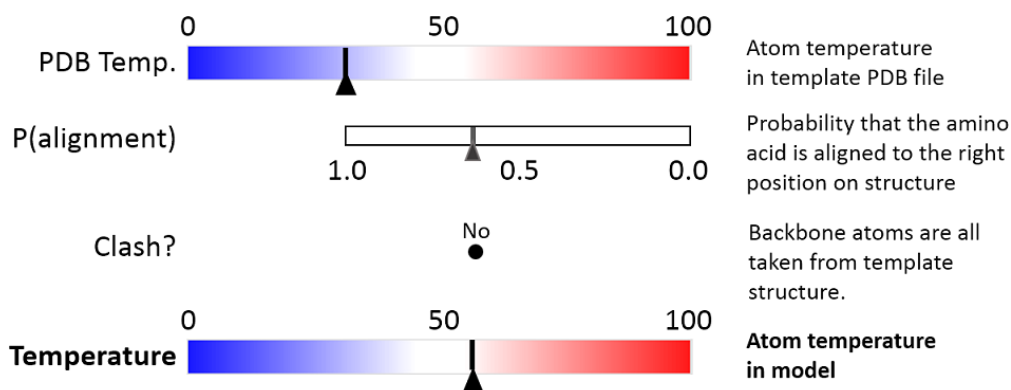

Figure 25.84: Evaluation of temperature color for backbone atoms in structure models.

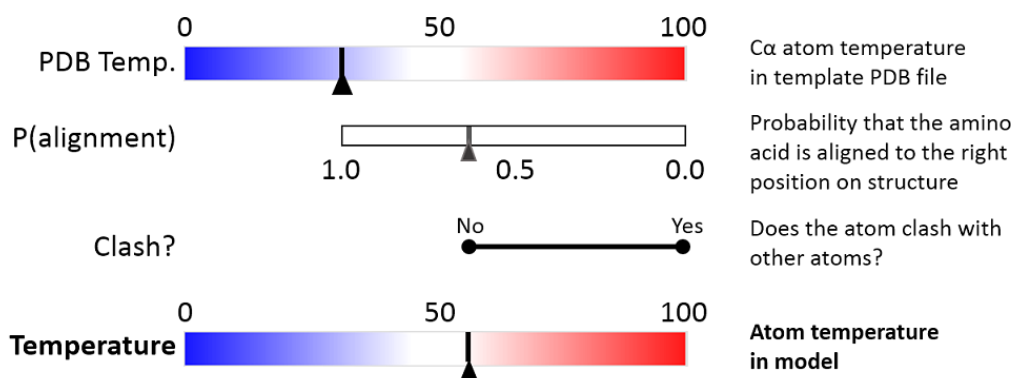

Figure 25.85: Evaluation of temperature color for side chain atoms in structure models.

Visualization		Property viewer	
Atom selection (1 atom)			
Molecule	Model (CDK5_HUMAN)		
Residue	LEU 98 (A)		
Name	CB (Carbon)		
Hybridization	SP3		
Charge	0.00		
Source: Modeled			
Temperature	99.15		
PDB Temp.	21.85		
P(alignment)	0.01		
Clash?	No		
Occupancy	0.00		

Figure 25.86: Information displayed in the Side Panel Property viewer for a modeled atom.

Note: For NMR structures, the temperature factor is set to zero in the PDB file, and the "Color by Temperature" will therefore suggest that the structure is more well determined than is actually the case.

P(alignment)

Alignment error is one of the largest causes of model inaccuracy, particularly when the model is built from a template sharing low sequence identity (e.g. lower than 60%). Misaligning a single amino acid by one position will cause a ca. 3.5 Å shift of its atoms from their true positions.

The estimate of the probability that two amino acids are correctly aligned, P(alignment), is obtained

by averaging over all the possible alignments between two sequences, similar to [Knudsen and Miyamoto, 2003].

This allows local alignment uncertainty to be detected even in similar sequences. For example the position of the D in this alignment:

```
Template  GGACDAEDRSTRSTACE---GG
Target   GGACD---RSTRSTACEKLMGG
```

is uncertain, because an alternative alignment is as likely:

```
Template  GGACDAEDRSTRSTACE---GG
Target   GGAC---DRSTRSTACEKLMGG
```

Clash?

Clashes are evaluated separately for each atom in a side chain. The scoring function used to evaluate protein-ligand interactions for docking and ligand optimization in *CLC Drug Discovery Workbench* is also used to evaluate the interaction between a given side chain atom and its surroundings.

If the atom is considered to clash, it will be assigned a temperature of 100.

Note: Clashes within the modeled protein chain as well as with all other molecules in the downloaded PDB file (except water) are considered.

Ranking structures

The protein sequence of the gene affected by the variant (the query sequence) is BLASTed against the protein structure sequence database (section 25.16.6).

A *template quality score* is calculated for the available structures found for the query sequence. The purpose of the score is to rank structures considering both their quality and their homology to the query sequence.

The five descriptors contributing to the score are:

- E-value
- % Match identity
- % Coverage
- Resolution (of crystal structure)
- Free R-value (R_{free} of crystal structure)

Each of the five descriptors are scaled to [0,1], based on the linear functions seen in figure 25.88. The five scaled descriptors are combined into the *template quality score*, weighting them to emphasize homology over structure qualities.

$$\text{Template quality score} = 3 \cdot S_{\text{E-value}} + 3 \cdot S_{\text{Identity}} + 1.5 \cdot S_{\text{Coverage}} + S_{\text{Resolution}} + 0.5 \cdot S_{\text{Rfree}}$$

E-value is a measure of the quality of the match returned from the BLAST search. You can read more about BLAST and E-values in section 11.5.

% **Match identity** is the identity between the query sequence and the BLAST hit in the matched region. It is evaluated as

$$\% \text{ Match identity} = 100\% \cdot (\text{Identity in BLAST alignment})/L_B$$

where L_B is the length of the BLAST alignment of the matched region, as indicated in figure 25.87, and "Identity in BLAST alignment" is the number of identical positions in the matched region.

% **Coverage** indicates how much of the query sequence has been covered by a given BLAST hit (see figure 25.87). It is evaluated as

$$\% \text{ Coverage} = 100\% \cdot (L_B - L_G)/L_Q$$

where L_G is the total length of gaps in the BLAST alignment and L_Q is the length of the query sequence.

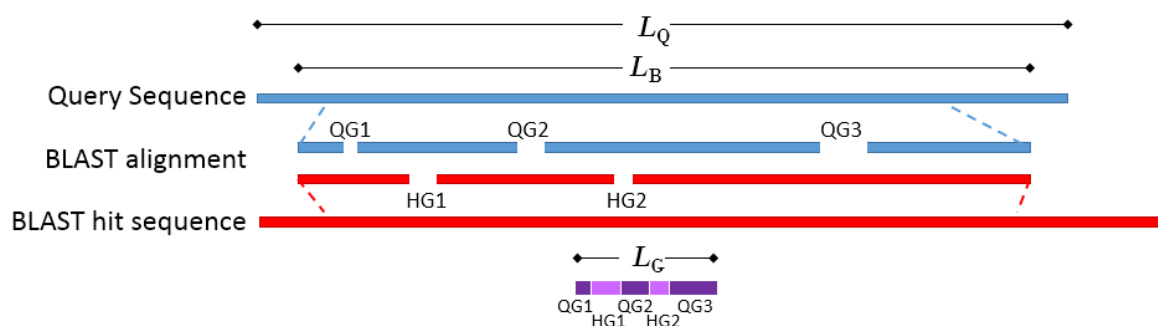

Figure 25.87: Schematic of a query sequence matched to a BLAST hit. L_Q is the length of the query sequence, L_B is the length of the BLAST alignment of the matched region, QG1-3 are gaps in the matched region of the query sequence, HG1-2 are gaps in the matched region of the BLAST hit sequence, L_G is the total length of gaps in the BLAST alignment.

The **resolution** of a crystal structure is related to the size of structural features that can be resolved from the raw experimental data.

R_{free} is used to assess possible overmodeling of the experimental data.

Resolution and R_{free} are only given for crystal structures. NMR structures will therefore usually be ranked lower than crystal structures. Likewise, structures where R_{free} has not been given will tend to receive a lower rank. This often coincides with structures of older date.

How a model structure is created

A structure model is created by mapping the query sequence onto the template structure based on a sequence alignment (see figure 25.89):

- For identical amino acids (example 1 in figure 25.89) => Copy atom positions from the PDB file. If the side chain is missing atoms in the PDB file, the side chain is rebuilt (section 25.16.2).

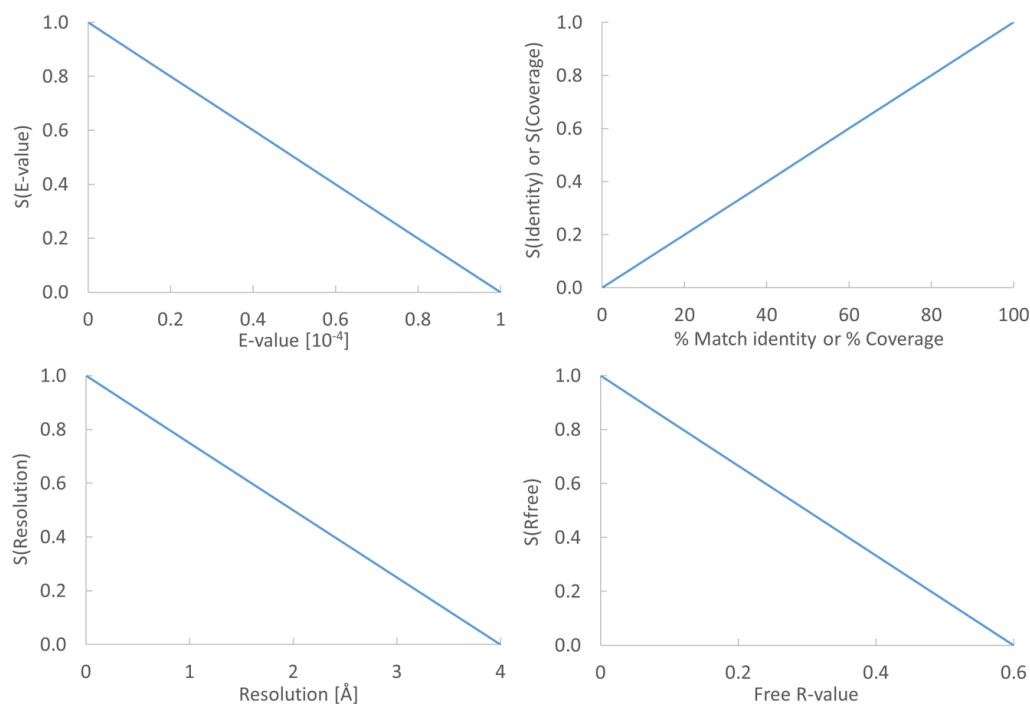

Figure 25.88: From the E-value, % Match identity, % Coverage, Resolution, and Free R-value, the contributions to the "Template quality score" are determined from the linear functions shown in the graphs.

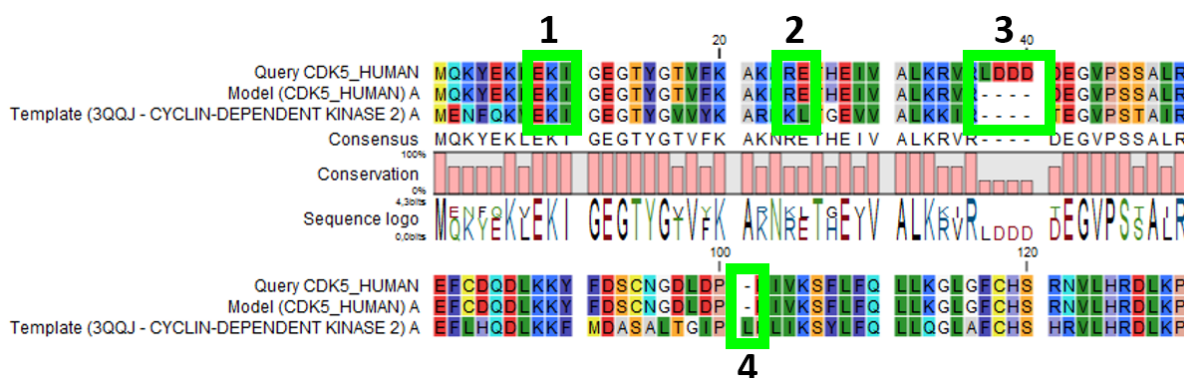

Figure 25.89: Sequence alignment mapping query sequence (Query CDK5_HUMAN) to the structure with sequence "Template(3QQJ - CYCLIN-DEPENDENT KINASE 2)", producing a structure with sequence "Model(CDK5_HUMAN)". Examples are highlighted: 1. Identical amino acids, 2. Amino acid changes, 3. Amino acids in query sequence not aligned to a position on the template structure, and 4. Amino acids on the template structure, not aligned to query sequence.

- For amino acid changes (example 2 in figure 25.89) => Copy backbone atom positions from the PDB file. Model side chain atom positions to match the query sequence (section 25.16.2).
- For amino acids in the query sequence not aligned to a position on the template structure (example 3 in figure 25.89) => No atoms are modeled. The model backbone will have a gap at this position and a "Structure modeling" issue is raised (see section 12.1.4).
- For amino acids on the template structure, not aligned to the query sequence (example 4

in figure 25.89) => The residues are deleted from the structure and a "Structure modeling" issue is raised (see section 12.1.4).

How side chains are modeled

Amino acid side chains tend to assume one of a discrete number of "rotamer" conformations. The rotamers used in *CLC Genomics Workbench* have been calculated from a non-redundant set of high-resolution crystal structures.

Side chains are modeled using a heat bath Monte Carlo simulated annealing algorithm, similar to the OPUS-Rota method [Lu et al., 2008]. The algorithm consists of approximately 100 cycles of simulation. In a single cycle, rotamers are selected for each side chain with a probability according to their energy. As the simulation proceeds, the selection increasingly favors the rotamers with the lowest energy, and the algorithm converges.

A local minimization of the modeled side chains is then carried out, to reduce unfavorable interactions with the surroundings.

Calculating the energy of a side chain rotamer

The total energy is composed of several terms:

- Statistical potential: This score accounts for interactions between the given side chain and the local backbone, and is estimated from a database of high-resolution crystal structures. It depends only on the rotamer and the local backbone dihedral angles ϕ and ψ .
- Atom interaction potential: This score is used to evaluate the interaction between a given side chain atom and its surroundings. It is the same score that is used to evaluate protein-ligand interactions for docking and ligand optimization in *CLC Drug Discovery Workbench*.
- Disulfide potential: Only applies to cysteines. It follows the form used in the RASP program [Miao et al., 2011] and serves to allow disulfide bridges between cysteine residues. It penalizes deviations from ideal disulfide geometry. A distance filter is applied to determine if the disulfide potential should be used, and when it is applied the atom interaction potential between the two sulfur atoms is turned off. Note that disulfide bridges are not formed between separate chains.

Note: The atom interaction potential considers interactions within the modeled protein chain as well as with all other molecules in the downloaded PDB file (except water).

Local minimization of side chain

After applying a side chain rotamer from the library to the backbone, a local minimization may be carried out for rotations around single bonds in the side chain.

The potential to minimize with respect to bond rotation is composed of the following terms:

- Atom interaction potential: Same as for calculating the energy of a rotamer.
- Disulfide potential: Same as for calculating the energy of a rotamer.
- Harmonic potential: This penalizes small deviations from ideal rotamers according to a harmonic potential. This is motivated by the concept of a rotamer representing a minimum energy state for a residue without external interactions.

25.16.6 Download 3D Protein Structure Database

This tool downloads the 3D Protein Structure Database from a public accessible HTTP location hosted by QIAGEN Aarhus.

The database contains a curated set of sequences with known 3D structures, which are obtained from the Protein Data Bank (<http://www.wwpdb.org>) [Berman et al., 2003]. The information stored in the database (e.g. protein sequence, X-ray resolution) is used to identify suitable structural templates when using the **Link Variants to 3D Protein Structure** tool.

To download the database, select:

Toolbox | Resequencing Analysis (📁) | **Functional Consequences** (📁) | **Download 3D Protein Structure Database** (📁)

If you are connected to a server, you will first be asked about whether you want to download the data locally or on a server. In the next wizard step you are asked to select the download location (see figure 25.90).

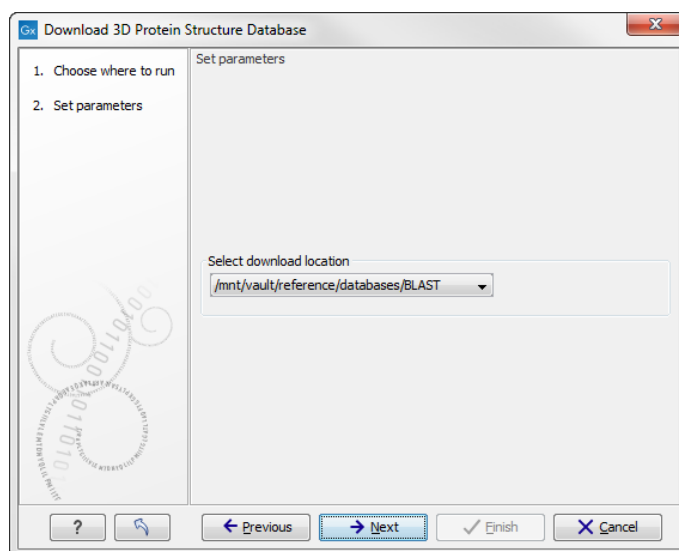

Figure 25.90: Select the download location.

The downloaded database will be installed in the same location as local BLAST databases (e.g. <username>/CLCdatabases) or at a server location if the tool was executed on a CLC Server. From the wizard it is possible to select alternative locations if more than one location is available.

When new databases are released, a new version of the database can be downloaded by invoking the tool again (the existing database will be replaced).

If needed, the **Manage BLAST Databases** tool can be used to inspect or delete the database (the database is listed with the name 'ProteinStructureSequences'). You can find the tool here:

BLAST (📁) | **Manage BLAST Databases** (📁)

25.17 Identify Known Mutations from Sample Mappings

The **Identify Known Mutations from Sample Mappings** tool can be used to look up known genomic variants in read mappings. This can be done in one or more samples by comparing a track of known variants with the read mappings of interest .

The **Identify Known Mutations from Sample Mappings** tool does not perform any kind of variant calling, which means that this tool cannot be used to find de novo variants. Rather, the tool is intended for identification of variants that have already been reported .

You need two types of input for the **Identify Known Mutations from Sample Mappings** tool:

- A variant track that holds the specific variants that you wish to test for.
- The read mapping(s) that you wish to check for the presence (or absence) of specific variants.

The **Identify Known Mutations from Sample Mappings** tool has two kinds of outputs:

- An overview track with information about:
 - whether the variant could be detected or not
 - whether the coverage was sufficient at the given position
 - the frequency of the variant in each sample.
- Individual output tracks for each sample that show the observed frequency, average base quality, forward/reverse read balance, zygosity and observed allele count.

25.17.1 How to run the Identify Known Mutations from Sample Mappings tool

To run the "Identify Known Mutations from Sample Mappings" tool go to the toolbox:

Toolbox | Resequencing (🔍) | Identify Known Mutations from Sample Mappings (🔍)

This opens the wizard shown in figure 25.91.

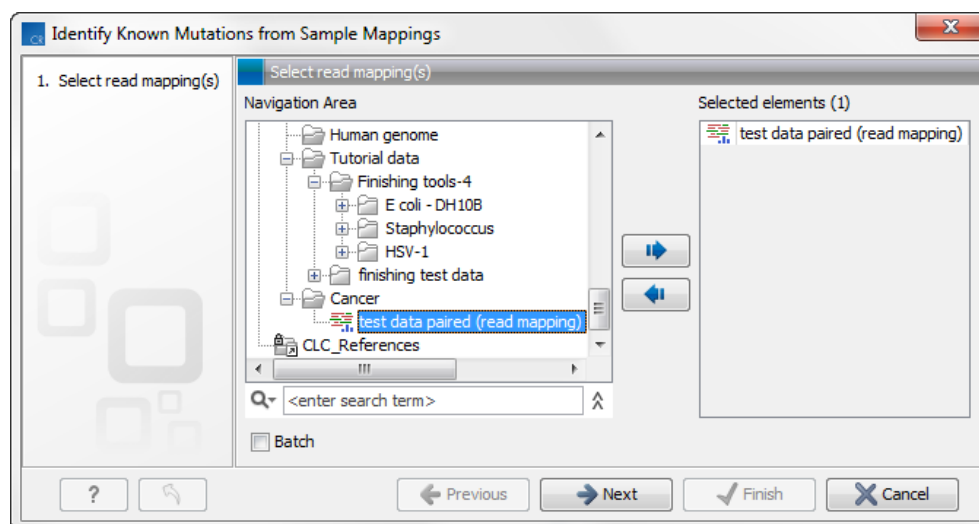

Figure 25.91: Select the read mapping(s) to analyze.

Select the read mapping(s) to analyze and click on the button labeled **Next**.

In the next wizard that appears, you get the following options:

Variant track

- **Variant track** Select the variant track that contains the specific variants that you wish to test for in your read mapping (figure 25.92). **Note!** You can only select one variant track at the time. If you wish to compare with more than one variant track, you must run the analysis with each individual variant track at the time.

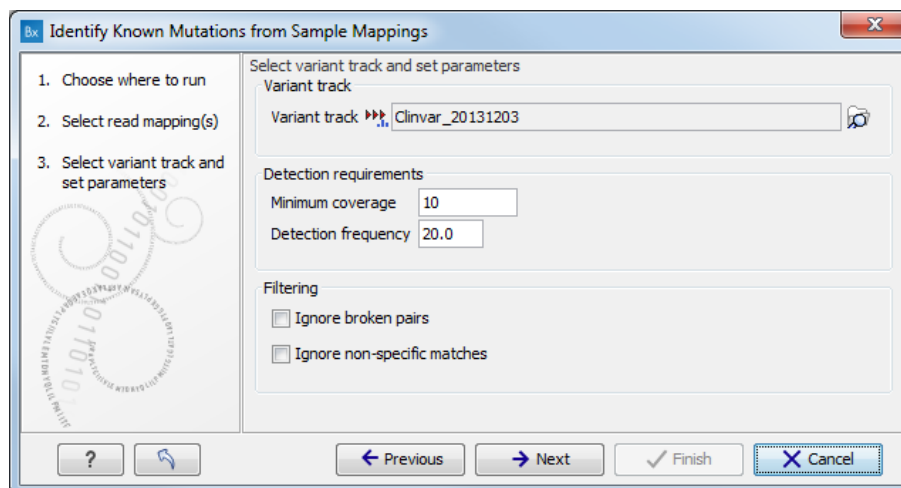

Figure 25.92: Select the variant track with the variants that you wish to use for variant testing. In this example we will use "Clinvar".

Detection requirements

- **Minimum coverage** The minimum number of reads that covers the position of the variant, which is required to set "Sufficient Coverage" to YES.
- **Detection frequency** The minimum allele frequency that is required to annotate a variant as being present in the sample. The same threshold will also be used to determine if a variant is homozygous or heterozygous. In case the most frequent alternative allele at the position of the considered variant has a frequency of less than this value, the zygosity of the considered variant will be reported as being homozygous.

Filtering

- **Ignore broken pairs** When ticked, reads from broken pairs are ignored. Broken pairs may arise for a number of reasons, one being erroneous mapping of the reads. In general, variants based on broken pair reads are likely to be less reliable, so ignoring them may reduce the number of spurious variants called. However, broken pairs may also arise for biological reasons (e.g. due to structural variants) and if they are ignored some true variants may go undetected.
- **Ignore non-specific matches** Reads that have an equally good match elsewhere on the reference genome (these reads are colored yellow in the mapping view) can be ignored in the analysis. Whether you include these reads or not will be a tradeoff between sensitivity and specificity. Including them may lead to the prediction of transcripts that are not correct, whereas excluding them may mean that you will lose some true transcripts.

Click on the button labeled **Next** to go to the next wizard step (figure 25.93). At this step the output options can be adjusted.

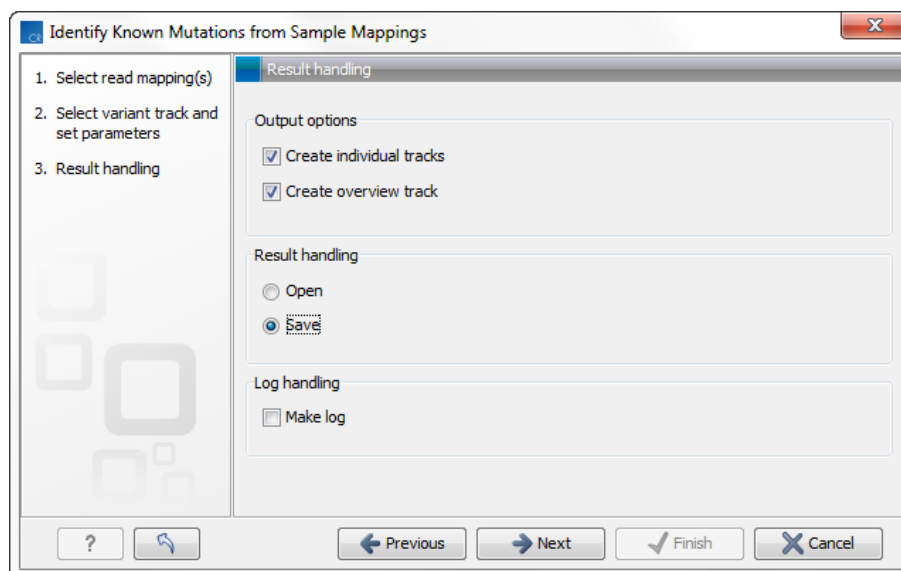

Figure 25.93: Select the desired output format(s). If using the default settings, two types of output will be generated; individual tracks and overview tracks.

The output options are:

- **Create individual track** For each read mapping an individual track is created with the observed frequency, average base quality, forward/reverse read balance, zygosity and observed allele count.
- **Create overview track** The overview track is a summary for all samples with information about whether the coverage is sufficient at a given variant position and if the variant has been detected; the frequency of the variant.

Specify where to save the results and click on the button labeled **Finish**.

25.17.2 Output from the Identify Known Mutations from Sample Mappings workflow

One individual sample output track will be created for each read mapping analyzed, while one overview track will be created per analysis (figure 25.94).

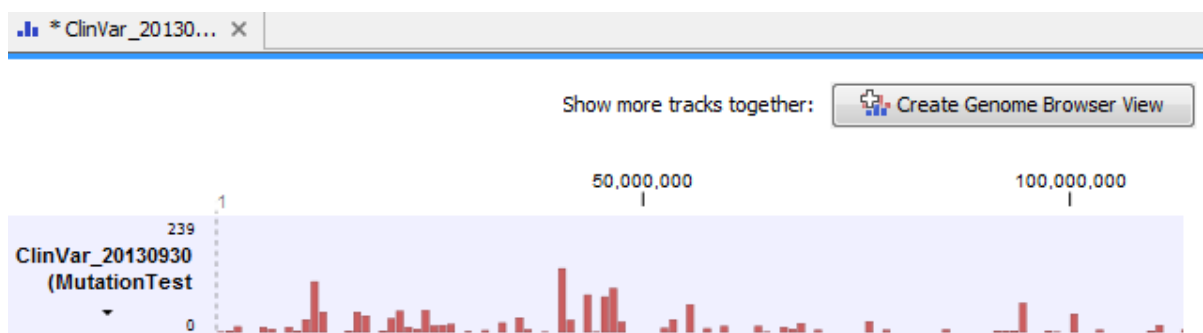

Figure 25.94: Overview track of read mappings tested against a Clinvar variant track.

At the bottom of the window it is possible to switch to a table view that lists all the mutations from the variant track that were found in your sample mapping.

In the individual track, the variant has been annotated with the following information:

- **Zygoty** Homozygous or Heterozygous (based on the parameter "Detection frequency" setting)
- **Count** Number of reads supporting the variant
- **Frequency** Frequency of the reads supporting the variant
- **Average Quality** Average quality of all bases supporting the variant
- **Forward/Reverse balance** Minimum ratio of forward and reverse reads supporting the variant
- **MFAA count** The Most Frequent Alternative Allele count (MFAA count) is the count of reads supporting the most frequent alternative allele at the position of the variant
- **MFAA frequency** Frequency of reads supporting the most frequent alternative allele at the position of the variant
- **MFAA forward read count** forward reads supporting the most frequent alternative allele at the position of the variant
- **MFAA reverse read count** reverse reads supporting the most frequent alternative allele at the position of the variant
- **MFAA forward/reverse balance** forward/reverse balance of the most frequent alternative allele at the position of the variant
- **MFAA average quality** average quality of the most frequent alternative allele at the position of the variant

In the overview track the variant has been annotated with the following information:

- ("**Sample name**") **coverage** Either Yes or No, depending on whether the coverage at the position of the variant was higher or lower than the user given threshold for minimum coverage.
- ("**Sample name**") **detection** Either Yes or No, depending on the minimum frequency settings chosen by the user.
- ("**Sample name**") **frequency** The variant frequency observed in this sample.
- ("**Sample name**") **zygoty** The zygoty observed in the sample. This setting is based on the minimum frequency setting made by the user. If this variant has been detected and the most frequent alternative allele at this position is also over the cutoff, the value is heterozygote.

An example of the individual and overview tables can be seen in figure [25.95](#).

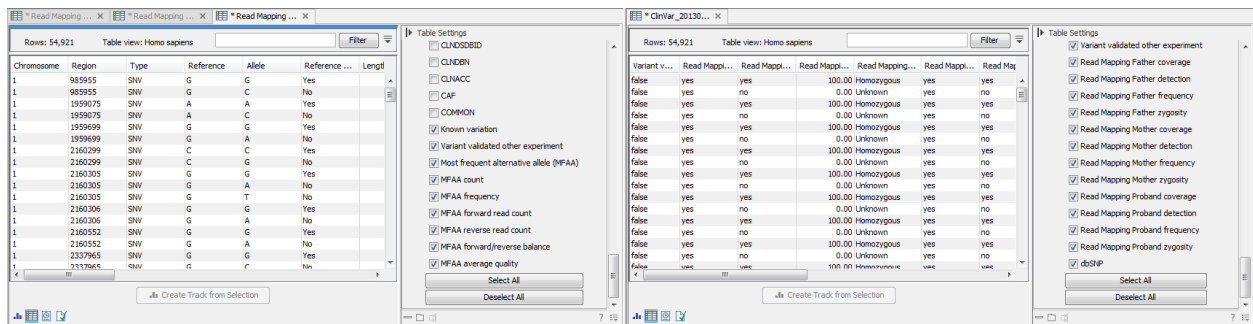

Figure 25.95: Table views of the individual track (left) and overview track (right).

Chapter 26

RNA-Seq Analysis tools

Contents

26.1 RNA-Seq analysis	757
26.1.1 Specifying reads and reference	757
26.1.2 Defining mapping options for RNA-Seq	759
26.1.3 The EM estimation algorithm	762
26.1.4 Calculating expression values from RNA-Seq	764
26.1.5 Specifying RNA-Seq outputs	767
26.1.6 Expression tracks	768
26.1.7 Reads track	773
26.1.8 RNA-Seq report	773
26.1.9 Gene fusion reporting	779
26.2 Create Combined RNA-Seq Report	780
26.3 Advanced RNA-Seq Tools	781
26.3.1 Expression tracks expression values	782
26.3.2 TMM Normalization	782
26.3.3 Metadata	783
26.4 PCA for RNA-Seq	783
26.4.1 Principal component analysis plot (2D)	784
26.4.2 Principal component analysis plot (3D)	785
26.5 Differential Expression for RNA-Seq	787
26.5.1 The statistical model	788
26.5.2 Output of the Differential Expression for RNA-Seq tool	790
26.5.3 Statistical comparison tracks	791
26.5.4 The volcano plot	792
26.6 Create Heat Map for RNA-Seq	793
26.6.1 Clustering of features and samples	794
26.6.2 The heat map view	796
26.7 Create Expression Browser	798
26.7.1 The expression browser	799
26.8 Create Venn Diagram for RNA-Seq	800
26.8.1 Venn diagram table view	802

Based on an annotated reference genome, the *CLC Genomics Workbench* supports **RNA-Seq Analysis** by mapping next-generation sequencing reads and distributing and counting the reads across genes and transcripts. Subsequently, the results can be used for expression analysis. Additional tools in the RNA-Seq folder require RNA-Seq input data in the form of Expression Tracks, unlike the tools included in the "Microarray and Small RNA" folder that also support microarray data or Experiment objects.

26.1 RNA-Seq analysis

The following describes the overall process of the RNA-Seq analysis when using an annotated eukaryote genome. See section 26.1.1 for more information on other types of reference data.

The RNA-Seq analysis is done in several steps: First, all annotated transcripts are extracted (using an *mRNA* track). If there are several annotated splice variants, they are all extracted.

An example is shown in figure 26.1.

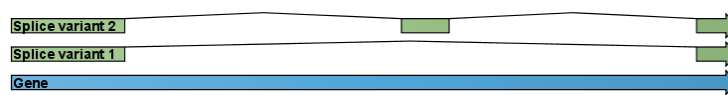

Figure 26.1: A simple gene with three exons and two splice variants.

This is a simple gene with three exons and two splice variants. The transcripts are extracted as shown in figure 26.2.



Figure 26.2: All the exon-exon junctions are joined in the extracted transcript.

Next, the reads are mapped against all the transcripts plus to the whole genome.

From this mapping, the reads are categorized and assigned to the genes using the EM estimation algorithm, and expression values for each gene and each transcript are calculated.

26.1.1 Specifying reads and reference

To start the RNA-Seq analysis, go to:

Toolbox | RNA-Seq Analysis (📄) | **RNA-Seq Analysis** (🇺🇸)

This opens a dialog where you select the **sequencing reads**. Note that you need to import the sequencing data into the Workbench before it can be used for analysis. Importing read data is described in section 6.3.

If you have several samples that you wish to analyze independently and compare afterwards, you can run the analysis in batch mode (see section 8.3).

Click **Next** when the sequencing data are listed in the right-hand side of the dialog.

You are now presented with the dialog shown in figure 26.3.

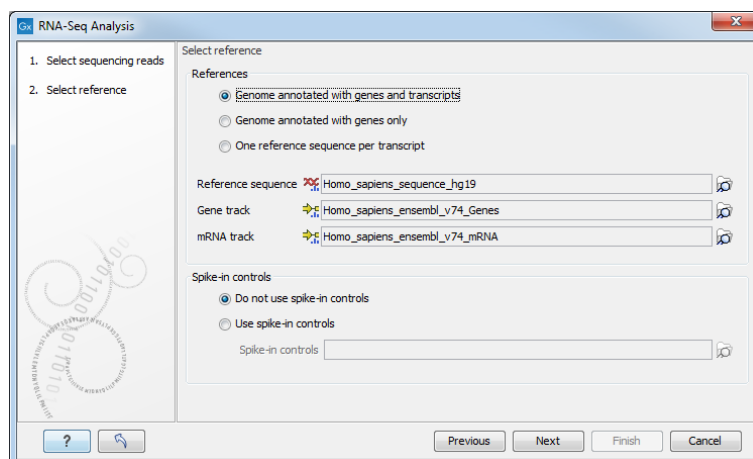

Figure 26.3: Defining a reference genome for RNA-Seq.

At the top, there are three options concerning how the reference sequences are annotated.

- **Genome annotated with genes and transcripts.** This option should be used when both gene and mRNA annotations are available. The mRNA annotations are used to define how the transcripts are spliced (as shown in figure 26.1). This option should be used for **Eukaryotes** since it is the only option where splicing is taken into account. Note that genes and transcripts are linked by name only (not by position, ID etc).

When this option is selected, both a *Gene* and an *mRNA* track should be provided in the boxes below. Annotated reference genomes be can obtained in various ways:

- Directly downloaded as tracks using the **Download Reference Genome Data** tool (see section 7.1).
 - Imported as tracks from fasta and gff/gtf files (see section 6.2)
 - Imported from Genbank or EMBL files and converted to tracks (see section 23.4).
 - Downloaded from Genbank (see section 7.2) and converted to tracks (see section 23.4).
- **Genome annotated with genes only.** This option should be used for **Prokaryotes** where transcripts are not spliced. When this option is selected, a *Gene* track should be provided in the box below. The data can be obtained in the same ways as described above.
 - **One reference sequence per transcript.** This option is suitable for situations where the reference is a list of sequences. Each sequence in the list will be treated as a "transcript" and expression values are calculated for each sequence. This option is most often used if the reference is a product of a *de novo* assembly of RNA-Seq data. It is also a suitable option for references where genes are particularly close to each other or clustered in operon structures (see section 26.1.1). When this option is selected, only the reference sequence should be provided, either as a sequence track or a sequence list.

Tightly packed genes and genes in operons For annotated references containing genes located very close to each other (including operon structures) only reads mapping completely within a gene's boundaries will be counted towards the expression value for that gene. If any part of a read maps outside a given gene's boundaries, then it will be considered intergenic and will not be counted towards the expression value. For tightly packed genes, especially in cases where non-coding 5' regions are not included in the gene annotation, this can be too conservative: if there are short genes, where the read length exceeds the gene length in some cases, then some granularity may be lost. That is, reads mapping to short genes might not be counted at all.

If this situation arises in your data, you can do the following:

- Use the option "One reference per transcript" in the "Select reference" wizard, and input a list of transcript sequences instead of a track. A list of sequences can be generated from a mRNA track (or a gene track for bacteria if no mRNA track is available) using the Extract Annotations tool (see section 13.1).
- In cases where the input reads are paired-end, choose the option "Count paired reads as two" in the Expression level options dialog. This will ensure that each read of the pair is counted towards the expression of the gene with which it overlaps, (by default, paired reads that map to different genes are not counted).

This strategy is equivalent to the option "Map to gene regions only (fast)" option that was available in the workbench released before February 2017.

At the bottom of the dialog you can choose between these two options:

- **Do not use spike-in controls.**
- **Use spike-in controls.** In this case, you can provide a spike-in control file in the field situated at the bottom of the dialog window. Make sure you remember to check the option to output a report in the last wizard step, as the report is the only place where the spike-in controls results will be available. During analysis, the spike-in data is added to the references. However, all traces of having used spike-ins are removed from the output tracks.

If spike-ins have been used, the quality control results are shown in the output report. So when using spike-in, make sure that the option to output a report is checked.

To learn how to import spike-in control files, see section 6.4.

26.1.2 Defining mapping options for RNA-Seq

When the reference has been defined, click **Next** and you are presented with the dialog shown in figure 26.4.

The mapping parameters are identical to those applying to **Map Reads to Reference**, as the underlying mapping is performed in the same way. For a description of the parameters, please see section 24.1.3.

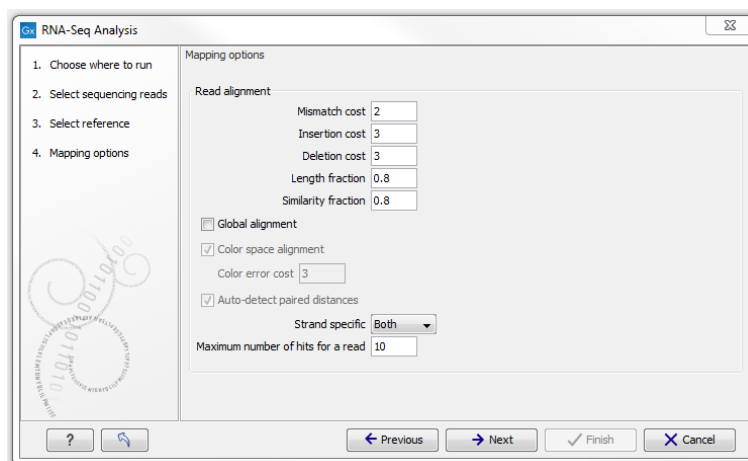

Figure 26.4: Defining mapping parameters for RNA-Seq.

For the estimation of paired reads distances, RNA-Seq uses the transcript level reference sequence information. This means that introns are not included in the distance measurement. The paired distance measurement will only include transcript sequence, reflecting the true nature of the sequence on which the paired reads were produced.

In addition to the generic mapping parameters, two RNA-Seq specific parameters can be set:

- **Maximum number of hits for a read.** A read that matches equally well to more *distinct* places in the references than the 'Maximum number of hits for a read' specified will not be mapped (the notion of *distinct* places is elaborated below). If a read matches to multiple distinct places, but less than the specified maximum number, it will be randomly assigned to one of these places. The random distribution is done by the EM algorithm (see section [26.1.3](#))

The definition of a *distinct* place in the references is complicated because each annotated transcript is extracted and used as reference for the read mapping (if the "Genome annotated with genes and transcripts" is selected in figure [26.3](#)). To exemplify, consider a gene with 10 transcripts and 11 exons, where all transcripts have exon 1, and each of the 10 transcripts have only one of the exons 2 to 11. Exon 1 will be represented 11 times in the references (once for the gene region and once for each of the 10 transcripts). Reads that match to exon 1 will thus match to 11 of the extracted references. However, when the mappings are considered in the coordinates of the main reference genome, it becomes evident that the 11 match places are not distinct but in fact identical. In this case this will just count as one distinct placement of the read, and it will *not* be discarded for exceeding the maximum number of hits limit. Similarly, when a multi-match read is randomly assigned to one of its match places, each distinct place is considered only once.

The limit for how many non-specific matches a read is allowed to have is applied first to the set of gene matches (if any), and then to intergenic matches. As an example using the default value of 10, if a read matches equally well 8 places within genes and 50 places in intergenic regions, it is still considered a valid match. It will only be discarded if the number of matches within genes is above the limit, or if there are no gene matches at all and the number of intergenic matches exceeds the limit.

Note that, although a read is mapped *distinctly* at the gene level, it does not necessarily map *uniquely* to a particular transcript of the gene. The above example with a gene with 10

transcripts and 11 exons, where all transcripts have exon 1, and each of the 10 transcripts have only one of the exons 2 to 11, is a good and easy to understand example of this: all reads that are mapped to exon 1 are *uniquely* mapped at the gene level but are *non-specific matches* at the transcript level. A more complicated example is that you may have a gene with transcript annotations where one transcript has a longer version of an exon than the other. In this case you may have reads that may either be mapped entirely within the long version of the exon, or across the exon-exon boundary of one of the transcripts with the short version of the exon. Such an example is provided by the gene 'Ftl1' in the example below (gene and mRNA annotations for that gene are shown in figure 26.5, along with the reads mapping to the gene).

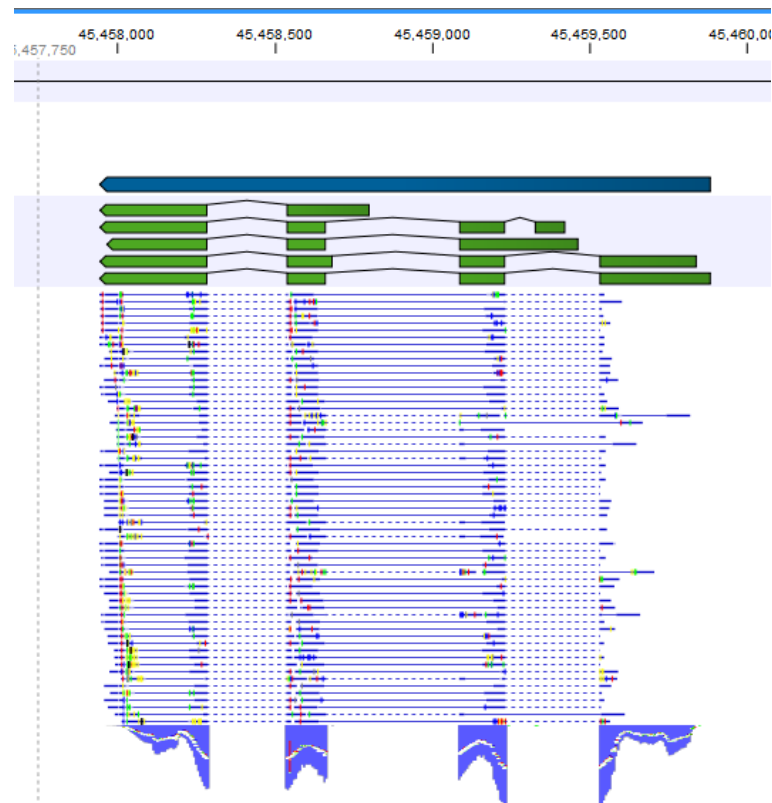

Figure 26.5: The gene 'Ftl1' from the mouse chromosome 7.

When you zoom in on the regions at the end of the second exons and the beginning of the third exons (Figure 26.6) you see that the reference sequence is identical in the start of the part of the second exons that is only present in the long version, and in the start of the third exons (they share the sequence 'CTGCACA'). So a read that is '...TCATCTTGAGATGGCTTCTGCACA' may be either mapped entirely within the long version of the second exons, or across the exon-exon boundary of the short version of the second exon and the third exon. For reporting expression levels at the transcript level, reads are assigned among the transcripts to which they map by the Expectation Maximization algorithm.

- **Strand-specific alignment.** When this option is checked, the user can specify whether the reads should be mapped only in their forward (or reverse) orientation. This will typically be appropriate when a strand specific protocol for read generation has been used. It allows assignment of the reads to the right gene in cases where overlapping genes are located on different strands. Without the strand-specific protocol, this would not be possible

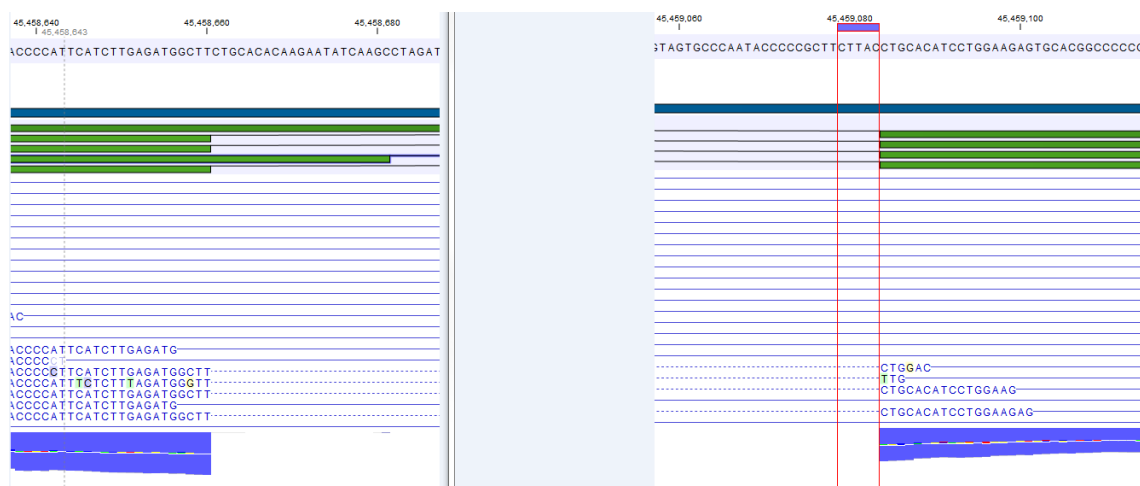

Figure 26.6: The regions at the end of the second exons and the beginning of the third exons of the mRNA transcripts for the gene 'Ftl1'.

(see [Parkhomchuk et al., 2009]). Also, applying the 'strand specific' 'reverse' option in an RNA-seq run could allow you to assess the degree of antisense transcription. Note that when running RNA seq with the strand specific option turned on you can only make use of pairs in forward-reverse orientation, meaning that mate pairs are not supported.

26.1.3 The EM estimation algorithm

The EM estimation algorithm is inspired by the RSEM and eXpress methods. It iteratively estimates the abundance of transcripts, and assigns reads to transcripts according to these abundances. To illustrate the interpretation of 'transcript abundance', consider the following two examples.

In the first example, we have a gene with two transcripts, where one transcript is twice as long as the other (figure 26.7). This longer transcript is also twice as abundant, meaning that in the exon common to both transcripts two of the three reads come from the longer transcript, and the final read comes from the shorter transcript. The longer transcript has a second exon which also generates two reads. We see then that the longer transcript is twice as abundant, but because it is twice as long it generates four times as many reads.

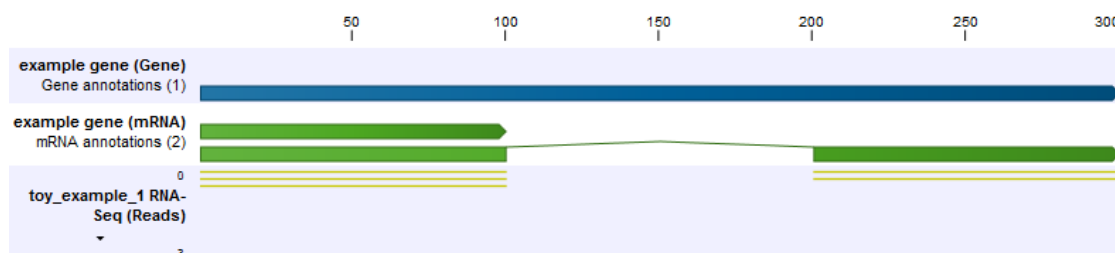

Figure 26.7: The longer transcript has twice the abundance, but four times the number of reads as the shorter transcript.

In the second example, the set up is the same, but now the shorter transcript is twice as abundant as the longer transcript (figure 26.8). Because the longer transcript is twice as long, there are equal numbers of reads from each transcript.

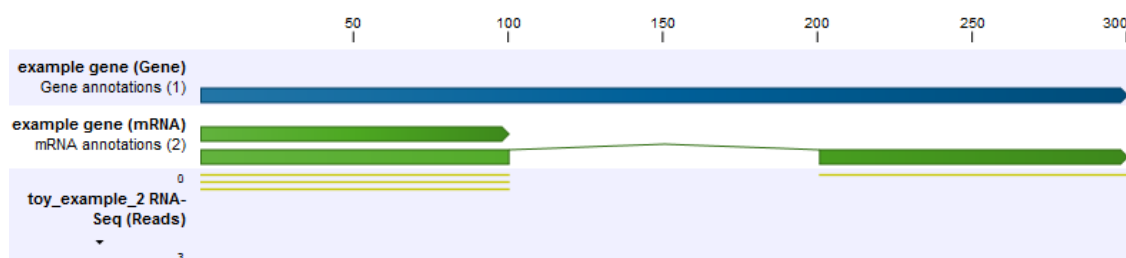

Figure 26.8: *The longer transcript has half the abundance, but the same number of reads as the shorter transcript.*

To estimate the transcript abundances, we carry out an expectation-maximization procedure. Before explaining the procedure, first we define the concept of a mapping. A mapping is a set of transcripts, to which a read may map. In the above examples, some reads have the mapping $a_1 = \{t_1, t_2\}$ (these are non-uniquely mapping reads), and some reads have the mapping $a_2 = \{t_2\}$ (these are ‘uniquely’ mapping reads). In both examples, the count of mapping a_1 is 3, because there are 3 shared reads between the transcripts. The count of mapping a_2 is 2 in the first example, and 1 in the second example.

The expectation-maximization algorithm proceeds as follows:

1. The transcript abundances are initialized to the uniform distribution, i.e. at the start all transcripts are assumed to be equally expressed.
2. Expectation step: the current (assumed) transcript abundances are used to calculate the expected count of each transcript, i.e. the number of reads we expect should be assigned to the given transcript. This is done by looping over all mappings that include the given transcript, and assigning a proportion of the total count of that mapping to the transcript. The proportion corresponds to the proportion of the total transcript abundance in the mapping that is due to the target.
3. Maximization step: the currently assigned counts of each transcript are used to re-compute the transcript abundances. This is done by looping over all targets, and for each target, dividing the proportion of currently assigned counts for the transcript (=total counts for transcript/total number of reads) by the target length. This is necessary because longer transcripts are expected to generate proportionally more reads.
4. Repeat from step 2 until convergence.

Below, we illustrate how the expectation-maximization algorithm converges to the expected abundances for the above two examples.

Example 1:

```
Initially: transcript 2 abundance = 0.50, count: 0.00, transcript 1 abundance = 0.50, count: 0.00
After 1 round: transcript 2 abundance = 0.54, count: 3.50, transcript 1 abundance = 0.46, count: 1.50
After 2 rounds: transcript 2 abundance = 0.57, count: 3.62, transcript 1 abundance = 0.43, count: 1.38
After 3 rounds: transcript 2 abundance = 0.59, count: 3.70, transcript 1 abundance = 0.41, count: 1.30
After 4 rounds: transcript 2 abundance = 0.60, count: 3.76, transcript 1 abundance = 0.40, count: 1.24
After 5 rounds: transcript 2 abundance = 0.62, count: 3.81, transcript 1 abundance = 0.38, count: 1.19
After 6 rounds: transcript 2 abundance = 0.62, count: 3.85, transcript 1 abundance = 0.38, count: 1.15
After 7 rounds: transcript 2 abundance = 0.63, count: 3.87, transcript 1 abundance = 0.37, count: 1.13
After 8 rounds: transcript 2 abundance = 0.64, count: 3.90, transcript 1 abundance = 0.36, count: 1.10
After 9 rounds: transcript 2 abundance = 0.64, count: 3.92, transcript 1 abundance = 0.36, count: 1.08
```

```

After 10 rounds: transcript 2 abundance = 0.65, count: 3.93, transcript 1 abundance = 0.35, count: 1.07
After 11 rounds: transcript 2 abundance = 0.65, count: 3.94, transcript 1 abundance = 0.35, count: 1.06
After 12 rounds: transcript 2 abundance = 0.65, count: 3.95, transcript 1 abundance = 0.35, count: 1.05
After 13 rounds: transcript 2 abundance = 0.66, count: 3.96, transcript 1 abundance = 0.34, count: 1.04
After 14 rounds: transcript 2 abundance = 0.66, count: 3.97, transcript 1 abundance = 0.34, count: 1.03
After 15 rounds: transcript 2 abundance = 0.66, count: 3.97, transcript 1 abundance = 0.34, count: 1.03

```

Example 2:

```

Initially: transcript 2 abundance = 0.50, count: 0.00, transcript 1 abundance = 0.50, count: 0.00
After 1 round: transcript 2 abundance = 0.45, count: 2.50, transcript 1 abundance = 0.55, count: 1.50
After 2 rounds: transcript 2 abundance = 0.42, count: 2.36, transcript 1 abundance = 0.58, count: 1.64
After 3 rounds: transcript 2 abundance = 0.39, count: 2.26, transcript 1 abundance = 0.61, count: 1.74
After 4 rounds: transcript 2 abundance = 0.37, count: 2.18, transcript 1 abundance = 0.63, count: 1.82
After 5 rounds: transcript 2 abundance = 0.36, count: 2.12, transcript 1 abundance = 0.64, count: 1.88
After 6 rounds: transcript 2 abundance = 0.35, count: 2.08, transcript 1 abundance = 0.65, count: 1.92
After 7 rounds: transcript 2 abundance = 0.35, count: 2.06, transcript 1 abundance = 0.65, count: 1.94
After 8 rounds: transcript 2 abundance = 0.34, count: 2.04, transcript 1 abundance = 0.66, count: 1.96
After 9 rounds: transcript 2 abundance = 0.34, count: 2.03, transcript 1 abundance = 0.66, count: 1.97
After 10 rounds: transcript 2 abundance = 0.34, count: 2.02, transcript 1 abundance = 0.66, count: 1.98
After 11 rounds: transcript 2 abundance = 0.34, count: 2.01, transcript 1 abundance = 0.66, count: 1.99
After 12 rounds: transcript 2 abundance = 0.34, count: 2.01, transcript 1 abundance = 0.66, count: 1.99
After 13 rounds: transcript 2 abundance = 0.33, count: 2.01, transcript 1 abundance = 0.67, count: 1.99
After 14 rounds: transcript 2 abundance = 0.33, count: 2.00, transcript 1 abundance = 0.67, count: 2.00
After 15 rounds: transcript 2 abundance = 0.33, count: 2.00, transcript 1 abundance = 0.67, count: 2.00

```

Once the algorithm has converged, every non-uniquely mapping read is assigned randomly to a particular transcript according to the abundances of transcripts within the same mapping. The total transcript reads column reflects these assignments. The RPKM and TPM values are then computed from the counts assigned to each transcript.

26.1.4 Calculating expression values from RNA-Seq

When the reference has been defined, click **Next** and you are presented with the dialog shown in figure 26.9.

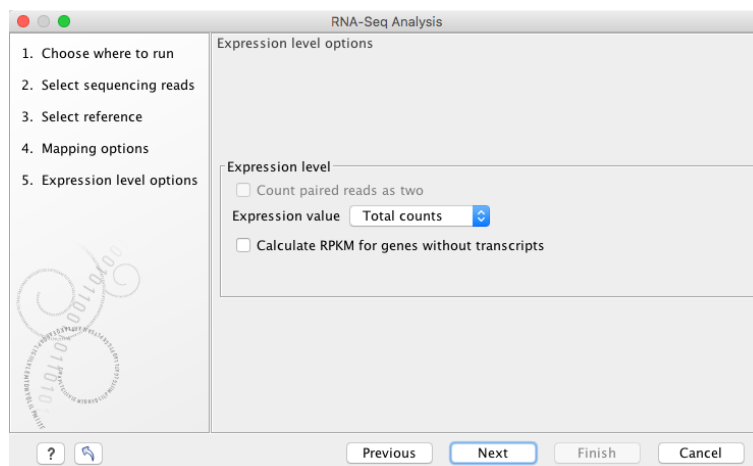

Figure 26.9: Defining how expression values should be calculated.

These parameters determine the way expression values are counted.

Count paired reads as two

The *CLC Genomics Workbench* supports the direct use of paired data for RNA-Seq. A combination of single reads and paired reads can also be used. There are three major advantages of using

paired data:

- Since the mapped reads span a larger portion of the reference, there will be fewer non-specifically mapped reads. This means that generally there is a greater accuracy in the expression values.
- This in turn means that there is a greater chance of accurately measuring the expression of transcript splice variants. As single reads (especially from the short reads platforms) typically only span one or two exons, many cases will occur where expression of splice variants sharing the same exons cannot be determined accurately. With paired reads, more combinations of exons will be identified as being unique for a particular splice variant.¹
- It is possible to detect **Gene fusions** when one read in a pair maps in one gene and the other part maps in another gene. Several reads exhibiting the same pattern supports the presence of a fusion gene.

You can read more about how paired data are imported and handled in section [6.3.9](#).

When counting the mapped reads to generate expression values, the *CLC Genomics Workbench* needs to be told how to handle the counting of paired reads. The default behavior of the *CLC Genomics Workbench* is to count fragments (FPKM) rather than individual reads when two reads map as an intact pair. That is, an intact pair is given a count of one. Reads from a pair are considered part of a broken pair when the reads map outside the estimated pair distance, map in the wrong orientation, or only one of the reads of the pair maps. Neither member of a broken pair is counted when the default counting scheme is used. The reasoning is that when reads map as a broken pair, it is an indication that something is not right. For example, perhaps the transcripts are not represented correctly on the reference or there are errors in the data. In general, more confidence can be placed on an intact pair representing transcription within the sample. If a combination of paired and single reads are input into the analysis, then single reads that map are given a count of one. This is different from reads input into the analysis as part of a pair, but where their partner did not map.

In some situations it may be too strict to disregard broken pairs as is done using the default counting scheme. This could be the case where there is a high degree of variation in the sample compared to the reference or where the reference lacks comprehensive transcript annotations. By checking the **Count paired reads as two** option, you choose to count mapped 'reads' (RPKM) rather than mapped 'fragments' (FPKM). That means that, the two reads in an intact pair are each counted as one mapped read (so an intact pair contributes with a total count of two), and mapped members of broken pairs will each get given a count of one. Single mapped reads are also given a count of one. Note that this approach does not represent the abundance of fragments being sequenced correctly, since the two reads of a pair derive from the same fragment, whereas a fragment sequenced with single reads only give rise to one read.

Note that whether you choose to calculate RPKM or FPKM, the value will be given in a column called "RPKM" for all subsequent analysis.

¹Note that the *CLC Genomics Workbench* only calculates the expression of the transcripts already annotated on the reference.

Expression value

Please note that reads that map outside genes are counted as intergenic hits only and thus do not contribute to the expression values. If a read maps equally well to a gene and to an inter-genic region, the read will be placed in the gene.

The expression values are created on two levels as two separate result files: one for genes and one for transcripts (if the "Genome annotated with genes and transcripts" is selected in figure 26.3). The content of the result files is described in section 26.1.5.

The **Expression value** parameter describes how expression per gene or transcript can be defined in different ways on both levels:

- **Total counts.** When the reference is annotated with genes only, this value is the total number of reads mapped to the gene. For un-annotated references, this value is the total number of reads mapped to the reference sequence. For references annotated with transcripts and genes, the value reported for each gene is the number of reads that map to the exons of that gene. The value reported per transcript is the total number of reads mapped to the transcript.
- **Unique counts.** This is similar to the above, except only reads that are uniquely mapped are counted (read more about the distribution of non-specific matches in section 26.1.2).
- **TPM.** (Transcripts per million). This is computed as $\frac{RPKM \cdot 10^6}{\sum RPKM}$, where the sum is over the RPKM values of all genes/transcripts.
- **RPKM.** This is a normalized form of the "Total counts" option (see more in section 26.1.4).

Please note that all values are present in the output. The **Expression value** in this dialog is solely used to inform the Workbench about which expression value should be applied when using the result in downstream analysis.

Calculate RPKM for genes without transcripts

For genes without annotated transcripts, the RPKM cannot be calculated since the total length of all exons is needed. By checking the **Calculate RPKM for genes without transcripts**, the length of the gene will be used in place of an "exon length". If the option is not checked, there will be no RPKM value reported for those genes.

Definition of RPKM

RPKM, Reads Per Kilobase of exon model per Million mapped reads, is defined in this way [Mortazavi et al., 2008]:

$$RPKM = \frac{\text{total exon reads}}{\text{mapped reads(millions)} \times \text{exon length (KB)}}$$

For prokaryotic genes and other non-exon based regions, the calculation is performed in this way:

$$RPKM = \frac{\text{total gene reads}}{\text{mapped reads(millions)} \times \text{gene length (KB)}}$$

Total exon reads This value can be found in the column with header **Total exon reads** in the expression track. This is the number of reads that have been mapped to exons (either within an exon or at the exon junction). When the reference genome is annotated with gene and transcript annotations, the mRNA track defines the exons, and the total exon reads are the reads mapped to all transcripts for that gene. When only genes are used, each gene in the gene track is considered an exon. When an un-annotated sequence list is used, each sequence is considered an exon.

Exon length This is the number in the column with the header **Exon length** in the expression track, divided by 1000. This is calculated as the sum of the lengths of all exons (see definition of exon above). Each exon is included only once in this sum, even if it is present in more annotated transcripts for the gene. Partly overlapping exons will count with their full length, even though they share the same region.

Mapped reads The sum of all mapped reads as listed in the RNA-Seq analysis report. If paired reads were used in the mapping, mapped fragments are counted here instead of reads, unless the **Count paired reads as two** option was selected. For more information on how expression is calculated in this case, see section 26.1.4.

26.1.5 Specifying RNA-Seq outputs

Clicking **Next** will allow you to specify the output options as shown in figure 26.10.

The main results of the RNA-Seq analysis are:

- **Expression Tracks** One track summarizing expression at the gene level is produced. The track name ends in **(GE)**. If the "Genome annotated with genes and transcripts" option was selected, as shown in figure 26.3, then a second track summarizing expression at the transcript level is also produced. This track has a name ending with **(TE)**.
- **Reads track** This track contains the mapping of the reads to the references. This track has a name ending with **(Reads)**.

In addition, the following optional results can be selected:

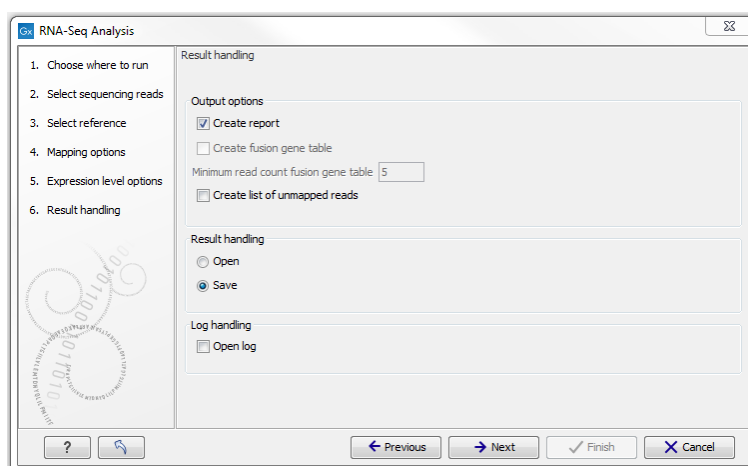

Figure 26.10: Selecting the output of the RNA-Seq analysis.

- **Create list of unmapped reads.** Creates a list of the reads that either did not map to the reference at all or that were non-specific matches with more placements than specified (see section 26.1.2). If you started with paired reads then more than one list of unmapped reads may be produced: paired reads are put in one list, with a name that ends in (paired), single reads, including members of broken pairs, are put in a read list with a name than ends in (single).
- **Create report.** Creates a report of the results. See **RNA-Seq report** below for a description of the information contained in the report. This report is also the only place results of the spike-in controls will be available.
- **Create fusion gene table.** An option that is enabled when using paired data. Creates a table that lists potential fusion genes. This, along with the **Minimum read count**, is described further below in section **Gene fusion reporting**.

26.1.6 Expression tracks

Both tracks can be shown in a **Table** (📄) and a **Graphical** (📊) view.

The expression track table view has three buttons (figure 26.11).

- The "Create track from Selection" will create a Track using selected rows.
- The "Select Genes in Other Views" button finds and selects the currently selected genes and transcripts in all other open expression track table views.
- The "Copy Gene Names to Clipboard" button copies the currently selected gene names to the clipboard.

By creating a **Track list**, the graphical view can be shown together with the read mapping track and tracks from other samples:

File | New | Track List (📄)

Select the mapping and expression tracks of the samples you wish to visualize together and select the annotation tracks used as reference for the RNA-Seq and click **Finish**.

Name	Gene name	Transcript...	Exons	ENSEMBL
DDX11L1_1	DDX11L1	1657	3	ENST00000456328, ENSE00002234944, ENSG00000223972, EN
DDX11L1_4	DDX11L1	1653	3	ENSE00002234632, ENSG00000223972, ENST00000515242, EN
DDX11L1_2	DDX11L1	1483	4	ENSG00000223972, ENST00000518655, ENSE00002269724, EN
DDX11L1_3	DDX11L1	632	6	ENSE00001758273, ENST00000450305, ENSE00001863096, EN
WASH7P_4	WASH7P	1416	9	ENSE00003497546, ENSG00000227232, ENSE00003638984, EN
WASH7P_5	WASH7P	1669	10	ENST00000423562, ENSE00003565315, ENSG00000227232, EN
WASH7P_3	WASH7P	1783	12	ENSE00003497546, ENSE00003638984, ENSE00001642865, EN
WASH7P_2	WASH7P	1351	11	ENSE00001890219, ENSE00003475637, ENSE00003502542, EN
WASH7P_1	WASH7P	1583	13	ENSE00002317443, ENSE00003632482, ENSE00003638984, EN
MIR1302-10_2	MIR1302-10	712	3	ENSE00001827679, ENSE00001947070, ENSG00000243485, EN
MIR1302-10_1	MIR1302-10	1583	2	ENSG00000243485, ENSE00001890064, ENSE00001841699, EN
FAM138A_1	FAM138A	1187	3	ENST00000417324, ENSE00001669267, ENSE00001656588, EN
FAM138A_2	FAM138A	590	2	ENSE00001618781, ENSE00001874421, ENSG00000237613, EN
OR4G4P_1	OR4G4P	126	2	ENSE00003074125, ENST00000594647, ENSE00003076518, EN
OR4F5_1	OR4F5	918	1	ENSG00000186092, ENSE00002319515, ENST00000335137
RP11-34P13.7_3	RP11-34P13.7	2748	4	ENSE00001846804, ENST00000466430, ENSG00000238009, EN
RP11-34P13.7_1	RP11-34P13.7	1210	2	ENSE00001807705, ENSE00001827725, ENSE00002220045, EN

Figure 26.11: RNA-Seq results shown in a table view.

Once the track list is shown, double-click the label of the expression track to show it in a table view.

Clicking a row in the table makes the track list view jump to that location, allowing for quick inspection of interesting parts of the RNA-Seq read mapping (see an example in figure 26.12).

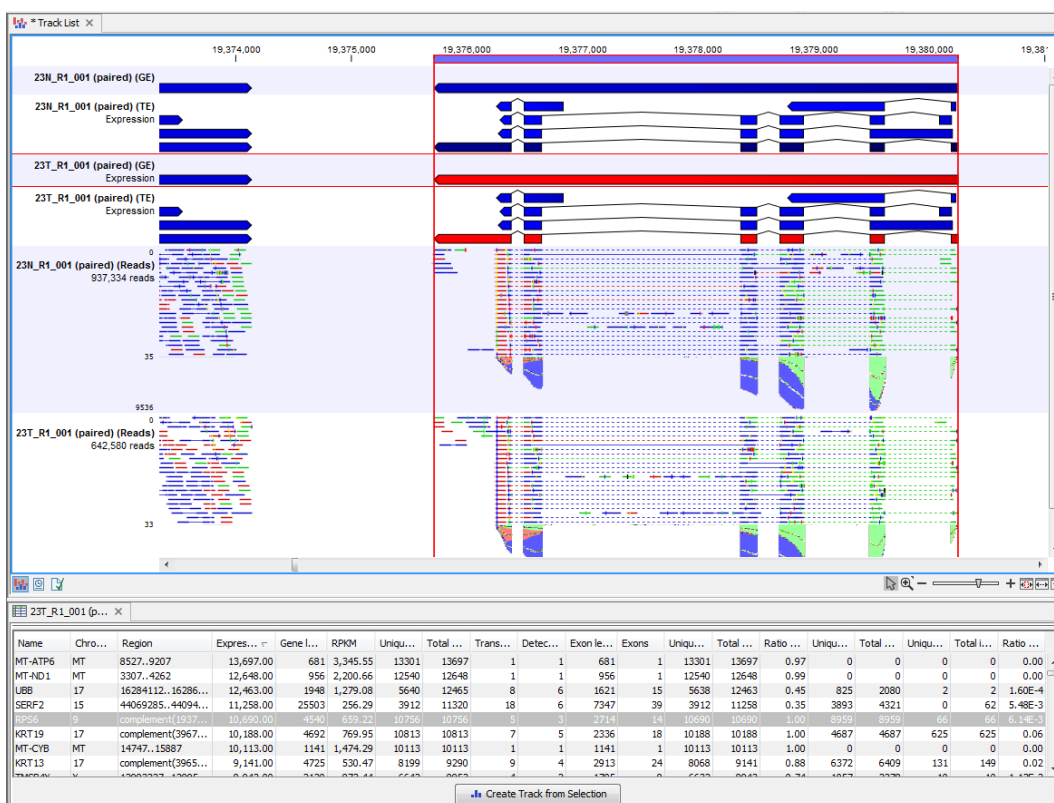

Figure 26.12: RNA-Seq results shown in a split view with an expression track at the bottom and a track list with read mappings of two samples at the top.

Reads spanning two exons are shown with a dashed line between each end as shown in figure

26.12, and the thin solid line represents the connection between two reads in a pair.

When doing comparative analysis, double click on one of the Expression or Statistical Comparison tracks in a track list to get its table view. Then click on the "Select genes in other views" button in any other table or expression browser will cause the track list to scroll to the selected gene.

Expression tracks can also be used to annotate variants using the **Annotate with Overlap Information** tool. Select the variant track as input and annotate with the expression track. For variants inside genes or transcripts, information will be added about expression (counts, expression value etc) from the gene or transcript in the expression track. Read more about the annotation tool in section 23.5.1.

Gene-level expression The gene-level expression track (GE) holds information about counts and expression values for each gene. It can be opened in a **Table view** (📄) allowing sorting and filtering on all the information in the track (see figure 26.13 for an example subset of an expression track).

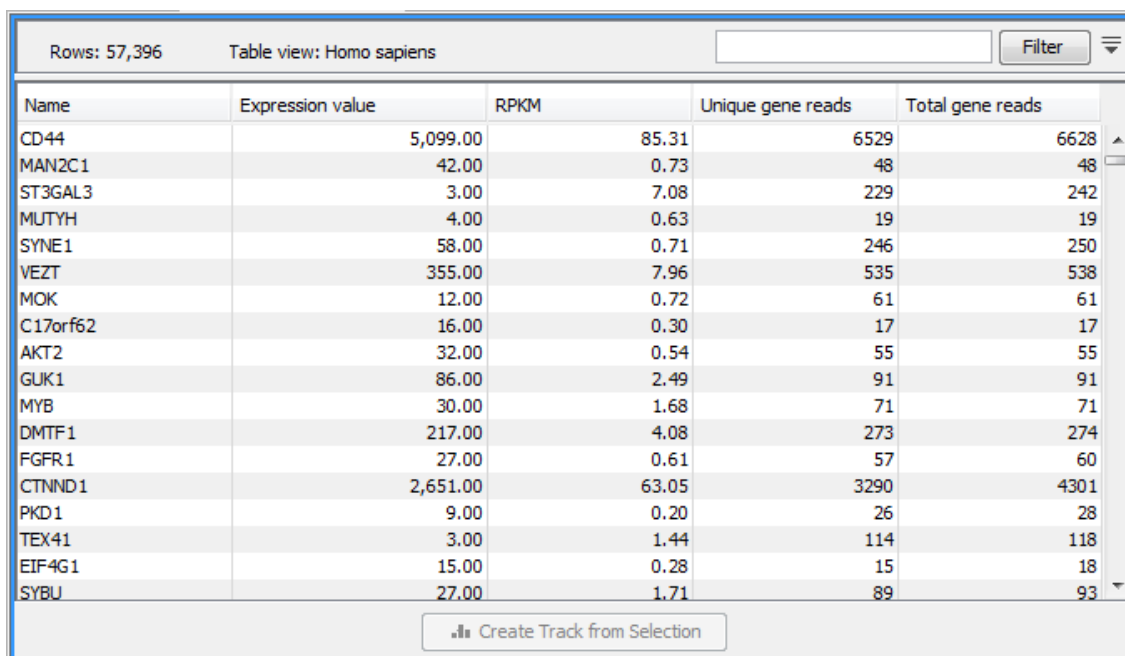

Name	Expression value	RPKM	Unique gene reads	Total gene reads
CD44	5,099.00	85.31	6529	6628
MAN2C1	42.00	0.73	48	48
ST3GAL3	3.00	7.08	229	242
MUTYH	4.00	0.63	19	19
SYNE1	58.00	0.71	246	250
VEZT	355.00	7.96	535	538
MOK	12.00	0.72	61	61
C17orf62	16.00	0.30	17	17
AKT2	32.00	0.54	55	55
GUK1	86.00	2.49	91	91
MYB	30.00	1.68	71	71
DMTF1	217.00	4.08	273	274
FGFR1	27.00	0.61	57	60
CTNND1	2,651.00	63.05	3290	4301
PKD1	9.00	0.20	26	28
TEX41	3.00	1.44	114	118
EIF4G1	15.00	0.28	15	18
SYBU	27.00	1.71	89	93

Figure 26.13: A subset of a result of an RNA-Seq analysis on the gene level. Not all columns are shown in this figure

Each row in the table corresponds to a gene (or reference sequence, if the **One reference sequence per transcript** option was used). The corresponding counts and other information is shown for each gene:

- **Name.** This is the name of the gene or the reference sequence, if the **One reference sequence per transcript** is used.
- **Chromosome and region.** The position of the gene on the genome.
- **Expression value.** This is based on the expression measure chosen as described in section 26.1.4.
- **Gene length** The length of the gene as annotated.

- **TPM (Transcripts per million).** This is computed as $\frac{RPKM \cdot 10^6}{\sum RPKM}$, where the sum is over the RPKM values of all genes/transcripts (see <http://bioinformatics.oxfordjournals.org/content/26/4/493.long>).
- **RPKM.** This is the expression value measured in RPKM [Mortazavi et al., 2008]: $RPKM = \frac{\text{total exon reads}}{\text{mapped reads (millions)} \times \text{exon length (KB)}}$. See section 26.1.4 for a detailed definition.
- **Unique gene reads.** This is the number of reads that match uniquely to the gene or its transcripts.
- **Total gene reads.** This is all the reads that are mapped to this gene - both reads that map uniquely to the gene or its transcripts and reads that matched to more positions in the reference (but fewer than the 'Maximum number of hits for a read' parameter) which were assigned to this gene.
- **Transcripts annotated.** The number of transcripts based on the mRNA annotations on the reference. Note that this is not based on the sequencing data - only on the annotations already on the reference sequence(s).
- **Detected transcripts.** The number of annotated transcripts to which reads have been assigned (see the description of transcript-level expression below).
- **Exon length.** The total length of all exons (not all transcripts).
- **Exons.** The total number of exons across all transcripts.
- **Unique exon reads.** The number of reads that match uniquely to the exons (including across exon-exon junctions).
- **Total exon reads.** Number of reads mapped to this gene that fall entirely within an exon or in exon-exon or exon-intron junctions. As for the 'Total gene reads' this includes both uniquely mapped reads and reads with multiple matches that were assigned to an exon of this gene.
- **Ratio of unique to total (exon reads).** The ratio of the unique reads to the total number of reads in the exons. This can be convenient for filtering the results to exclude the ones where you have low confidence because of a relatively high number of non-unique exon reads.
- **Unique exon-exon reads.** Reads that uniquely match across an exon-exon junction of the gene (as specified in figure 26.12). The read is only counted once even though it covers several exons.
- **Total exon-exon reads.** Reads that match across an exon-exon junction of the gene (as specified in figure 26.12). As for the 'Total gene reads' this includes both uniquely mapped reads and reads with multiple matches that were assigned to an exon-exon junction of this gene.
- **Unique intron-exon reads.** Reads that uniquely map across an intron-exon boundary of the gene.
- **Total intron reads.** Reads that maps across an intron-exon boundary of the gene.
- **Ratio of intron to total gene reads.** This can be convenient to identify genes with poor or lacking transcript annotations. If one or more exons are missing from the annotations, there will be a relatively high number of reads mapping in the intron.

Transcript-level expression If the "Genome annotated with genes and transcripts" option is selected in figure 26.3, a transcript-level expression track (TE) is also generated.

The track can be opened in a **Table view** (☰) allowing sorting and filtering on all the information in the track. Each row in the table corresponds to an mRNA annotation in the mRNA track used as reference.

- **Name.** This is the name of the transcript, if the **One reference sequence per transcript** is used.
- **Chromosome and region.** The position of the gene on the genome.
- **Expression value.** This is based on the expression measure chosen as described in section 26.1.4.
- **TPM (Transcripts per million).** This is computed as $\frac{RPKM \cdot 10^6}{\sum RPKM}$, where the sum is over the RPKM values of all genes/transcripts (see <http://bioinformatics.oxfordjournals.org/content/26/4/493.long>).
- **RPKM.** This is the expression value measured in RPKM [Mortazavi et al., 2008]: $RPKM = \frac{total\ exon\ reads}{mapped\ reads(millions) \times exon\ length\ (KB)}$. See section 26.1.4 for a detailed definition.
- **Relative RPKM.** The RPKM for the transcript divided by the maximum of the RPKM values among all transcripts of the same gene. This value describes the relative expression of alternative transcripts for the gene.
- **Gene name.** The name of the corresponding gene.
- **Transcript length.** This is the length of the transcript.
- **Exons.** The total number of exons in the transcript.
- **Transcript ID.** The transcript ID is taken from the transcript_id note in the mRNA track annotations and can be used to differentiate between different transcripts of the same gene.
- **Transcripts annotated.** The number of transcripts based on the mRNA annotations on the reference. Note that this is not based on the sequencing data - only on the annotations already on the reference sequence(s).
- **Detected transcripts.** The number of annotated transcripts to which reads have been assigned.
- **Unique transcript reads.** This is the number of reads in the mapping for the gene that are uniquely assignable to the transcript.
- **Total transcript reads.** Once the 'Unique transcript read's have been identified and their counts calculated for each transcript, the remaining (non-unique) transcript reads are assigned to one of the transcripts to which they match. The 'Total transcript reads' counts are the total number of reads that are assigned to the transcript once this assignment has been done. As for the assignment of reads among genes, the assignment of reads within a gene but among transcripts, is done by the EM estimation algorithm (section 26.1.3).

- **Ratio of unique to total (transcript reads).** The ratio of the unique reads to the total number of reads in the transcripts. This can be convenient for filtering the results to exclude the ones where you have low confidence because of a relatively high number of non-unique transcript reads.

Additional information to GE or TE tracks Both GE and TE tables can offer additional information such as hyperlinks to various databases (e.g., ENSEMBL, HGNC (HUGO Gene Nomenclature Committee), RefSeq, GeneID, etc.) In cases where the mRNA track or the gene track provided have biotype information, a biotype column will be added to the table.

26.1.7 Reads track

A track containing the mapped reads is generated. Details about viewing and editing of reads-tracks are described in section 23, and the resequencing is detailed in section 25. If you have chosen the strand specific option when setting up your analysis, it may be helpful to note that the colors of mapped single reads represent the orientation of the read relative to the reference provided. When a gene track is provided along with the reference genome, the reads will be mapped using the strand you specified, but the coloring of the read will be relative to the reference gene. If the reads matches the orientation of the gene it is colored green, and if it is opposite to the orientation of the gene it is colored red. A summary list of the colors to expect with different combinations of gene orientation and strand specific mapping options is:

- Strand specific, forward orientation chosen + gene on plus strand of reference = single reads colored green.
- Strand specific, forward orientation chosen + gene on minus strand of reference = single reads colored red.
- Strand specific, reverse orientation chosen + gene on plus strand of reference = single reads colored red.
- Strand specific, reverse orientation chosen + gene on minus strand of reference = single reads colored green.

See Figure 26.14 for an example of forward and reverse reads mapped to a gene on the plus strand.

Note: Reads mapping to intergenic regions will not be mapped in a strand specific way.

Although paired reads are coloured blue, they can be viewed as red and green 'single' reads by selecting the **Disconnect paired reads** box, within the Read Mapping Settings bar on the right-hand side of the track.

26.1.8 RNA-Seq report

An example of an RNA-seq report generated if you choose the **Create report** option is shown in figure 26.15.

The report is a collection of the sections described below, some sections included only based on the input provided when starting the tool. If a section is flagged with a pink highlight, it means

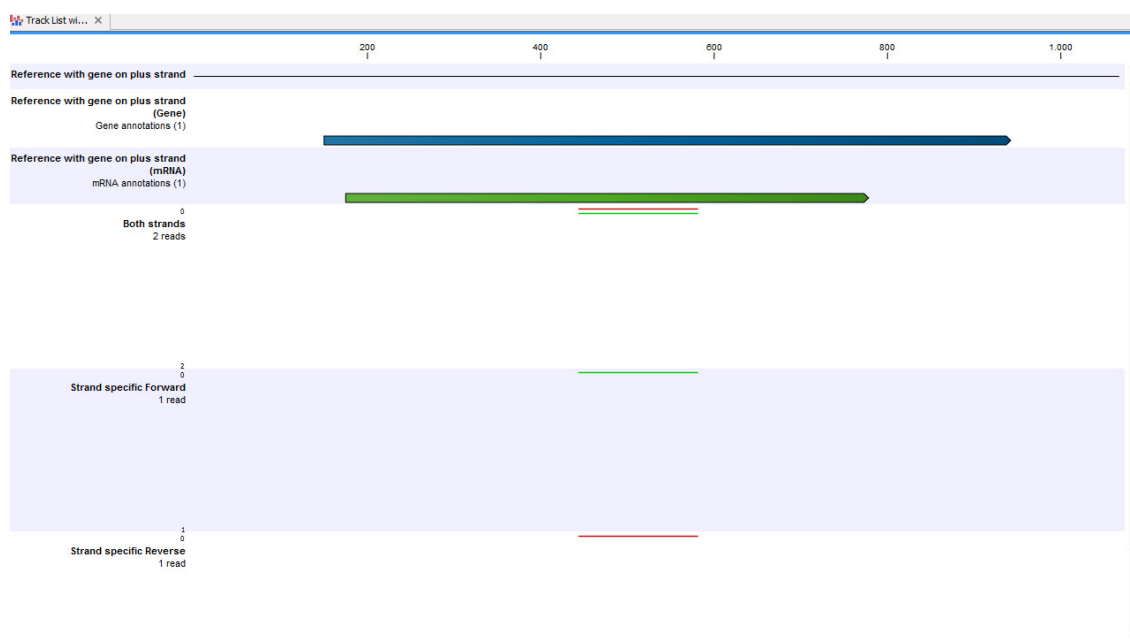

Figure 26.14: A track list showing a gene and transcript on the plus strand, and various mapping results. The first reads track shows a mapping of two reads (one 'forward' and one 'reverse') using strand specific 'both' option. Both reads map successfully; the forward read coloured green (because it matches the direction of the gene), and the reverse read coloured red. The second reads track shows a mapping of the same reads using strand specific ('forward') option. The reverse read does not map because it is not in the correct direction, therefore only the green forward read is shown. The final reads track shows a mapping of the same reads again but using strand specific 'reverse' option. This time, the green forward read does not map because it is in the wrong direction, and only the red reverse read is shown.

that something has almost certainly gone wrong in the sample preparation or analysis. A warning message tailored to the highlighted section is added to the report to help troubleshoot the issue. The report can be exported in PDF or Excel format.

Selected input sequences Information about the sequence reads provided as input, including the number of reads in each sample, as well as information about the reference sequences used and their lengths.

References Information about the total number of genes and transcripts found in the reference:

- **Transcripts per gene.** A graph showing the number of transcripts per gene.
- **Exons per transcript.** A graph showing the number of exons per transcript.
- **Length of transcripts.** A graph showing the distribution of transcript lengths.

Spike-in quality control

- **Spike-in plot.** A plot shows the expression of each spike-in as a function of the known concentration of that spike-in (see figure 26.16 to see an optimal spike-in plot).

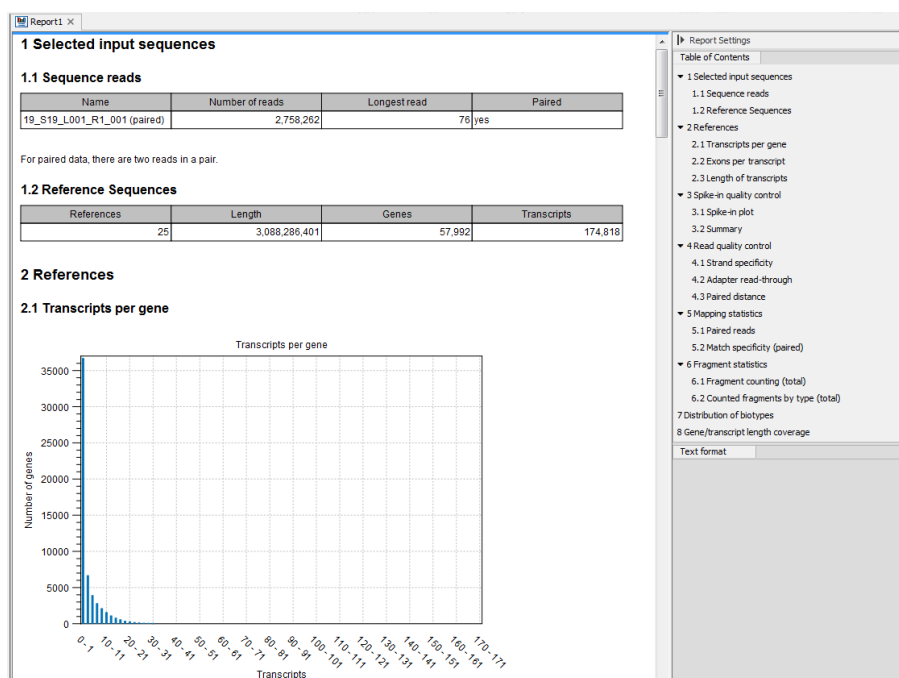

Figure 26.15: Report of an RNA-Seq run.

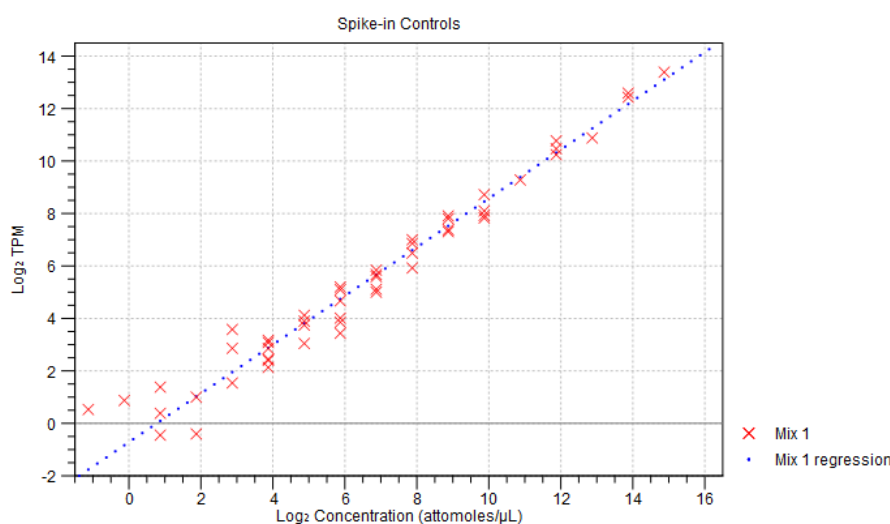
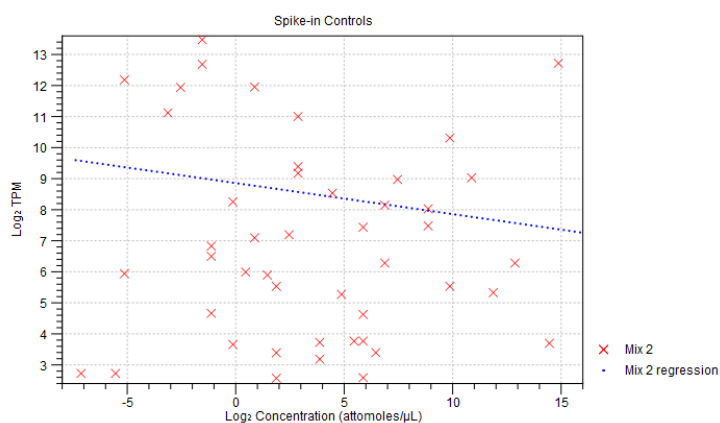

Figure 26.16: Spike-in plot showing how the points fall close to the regression line at high concentration.

- **Summary table.** A table provides more details on the spike-in detection. Figure 26.17 shows a failed spike-in control, with a table where results that require attention are highlighted in pink.

Under the table, a **warning message** explains what the optimal value was, and offers some troubleshooting measures: When samples have poor correlation ($R^2 < 0.8$) between known and measured spike-in concentrations, it indicates problems with the spike-in protocol, or a more serious problem with the sample. To troubleshoot, check that the correct spike-in file has been selected, and control the integrity of the sample RNA. Also, if fewer than 10000 reads mapped to spike-ins, check that the correct spike-in sequences are specified, and consider using more spike-in mix in future experiments.



3.2 Summary

Number of spike-ins detected	46/92
R ²	0.05
Reads mapped to spike-ins	7,336
% of reads mapped to spike-ins	3.10
Lower limit of detection (attomoles/μL)	0.03

Figure 26.17: Summary table where less than optimal results are highlighted.

Read quality control This section includes:

- A **strand specificity table** that indicates the direction of the RNA fragment that generated the read. In a strand-specific protocol almost all reads are generated from a specific orientation but otherwise, a mix of both orientations is expected.
 - A warning message will appear if over 90% of reads were mapped in the same orientation but the tool was run without using a strand specific setting ("Forward"/"Reverse").
 - If over 25% of the reads were filtered away due to the strand specific setting, try to re-run the tool with strand specific setting "Both". However, if a strand-specific protocol was used, library preparation may have failed.
- A **percentage of mapped paired-end reads containing read-through adapters**. If present in above 10% of the reads, adapters may lead to false positive variant calls, or prevent a transcript to be counted as such because of it going over the transcript described by the reference. Remaining read-through adapters can be removed using a Trim Adapter List configured to remove adapter sequences from the minus strand. In future experiments, consider selecting fragments that are longer than the read size.
- A **paired distance graph** (only included if paired reads are used) shows the distribution of paired-end distances, which is equivalent to the distribution of sequenced RNA fragment sizes. There should be a single broad peak at the target fragment size. An asymmetric peak may indicate problems in size selection.

Mapping statistics Shows statistics on:

- **Paired reads** or **Single reads**. The table included depends on the reads used. The table shows the number of reads mapped or unmapped, and in the case of paired reads, how many reads mapped in pairs and in broken pairs.

If over 50% of the reads did not map, and the correct reference genome was selected, this indicates a serious problem with the sample. To troubleshoot, the report offers the following options:

- Check that the correct reference genome and any relevant gene/mRNA tracks have been provided.
- The mapping parameters may be too strict. Try resetting them to the default values.
- Try mapping the un-mapped reads against possible contaminants. If the sample is contaminated, enrich for the target species before library preparation in future experiments.
- Library preparation may have failed. Check the quality of the sample RNA.

In case paired reads are used and over 40% of them mapped as broken pairs, the report hints that there could be problems with the tool settings, a low quality reference sequence, or incomplete gene/mRNA annotations. It could also indicate a more serious problem with the sample. To troubleshoot, it is suggested to:

- Check that the correct reference genome and any relevant gene/mRNA tracks have been provided.
 - Try re-running the tool with the "Auto-detect paired distances" option selected.
 - Check that the paired-end distances on the reads are set correctly. These are shown in the "Element Information" view on the reads. If these are correct, try re-running the tool without the "Auto-detect paired distances" option.
 - Try mapping the reads against possible contaminants. If the sample is contaminated, enrich for the target species before library preparation in future experiments.
- **Match specificity.** Shows a graph of the number of match positions for the reads. Most reads will be mapped 0 or 1 time, but there will also be reads matching more than once in the reference. The maximum number of match positions is limited in the **Maximum number of hits for a read** setting in figure 26.3. Note that the number of reads that are mapped 0 times includes both the number of reads that cannot be mapped at all and the number of reads that matches to more than the **Maximum number of hits for a read** parameter.

Fragment statistics

- **Fragment counting.** Lists the total number of fragments used for calculating expression, divided into uniquely and non-specifically mapped reads, as well as uncounted fragments (see the point below on match specificity for details).
- **Counted fragments by type.** Divides the fragments that are counted into different types, e.g., uniquely mapped, non-specifically mapped, mapped. A last column gives the percentage of fragments mapped for a particular type.
 - **Total gene reads.** All reads that map to the gene.
 - - **Intron.** From the total gene reads, reads that fall partly or entirely within an intron.
 - - **Exon.** From the total gene reads, reads that fall entirely within an exon or in an exon-exon junction.
 - - - **Exon.** From the total gene - exon reads, reads that map completely within an exon

- - - **Exon-exon.** From the total gene - exon reads, reads that map across an exon junction as specified in figure 26.12.
- **Intergenic.** All reads that map partly or entirely between genes.
- **Total.** Total amount of reads for a particular type.

Distribution of biotypes Table generated from biotype annotations present on the input gene or mRNA tracks. For a poly-A enrichment experiment, it is expected that the majority of reads correspond to protein-coding regions. For an rRNA depletion protocol, a variety of non-coding RNA regions may also be observed. The percentage of reads mapping to rRNA should usually be <15%.

If over 15% of the reads mapped to rRNA, it could be that the poly-A enrichment/rRNA depletion protocol failed. The sample can still be used for differential expression and variant calling, but expression values such as TPM and RPKM may not be comparable to those of other samples. To troubleshoot the issues in future experiments, check for rRNA depletion prior to library preparation. Also, if an rRNA depletion kit was used, check that the kit matches the species being studied.

Gene/transcript length coverage Plot showing the normalized coverage across a gene/transcript body for four different groupings of gene/transcript length (figure 26.18).

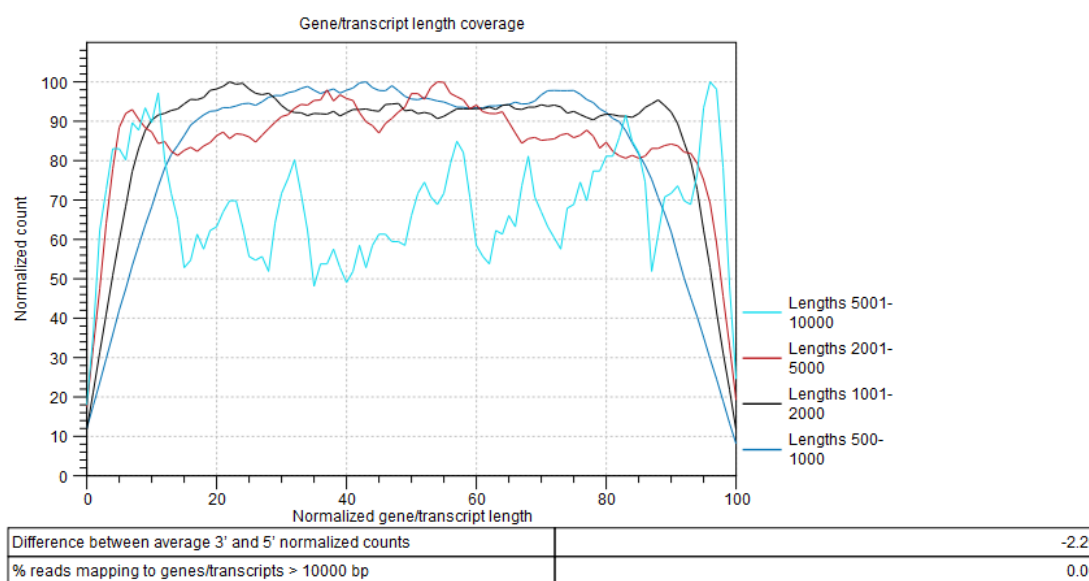

The plot shows the normalized coverage across a gene/transcript body for four different groupings of gene/transcript length. The lines should be flat in the center of the plot, and the plot should be approximately symmetric. An erratic line may indicate that there are few genes/transcripts in the given length range.

Figure 26.18: Gene/transcript length coverage plot.

The lines should be flat in the center of the plot, and the plot should be approximately symmetric. An erratic line may indicate that there are few genes/transcripts in the given length range. Lines showing normalized count higher on the 3' end indicates the presence of polyA tails in the reads, consequence of degraded RNAs. Future experiments may benefit from using an rRNA depletion protocol.

In the table below the plot, a difference between average 3' and 5' normalized counts higher than 25 warns that variants may not be called in low coverage regions, and that TPM or RPKM values may be unreliable. Most transcripts are <10000 bp long, so a warning is raised if many reads map to features longer than this. One possible cause is that no mRNA track has been provided for an organism with extensive splicing.

26.1.9 Gene fusion reporting

When using paired data, there is also an option to create an annotation track summarizing the evidence for gene fusions. An example is shown in figure 26.19.

Chromos...	Region	Name	Gene 1	Chromos...	Gene Region 2	Gene 2	Reads
1	complement(3205901..3671...	Xlr4-Cct4	Xlr4	11	22990519..23003780	Cct4	6
1	complement(3205901..3671...	Xlr4-Slc35e3	Xlr4	10	complement(117733679..1177...	Slc35e3	11
1	complement(4687934..4689...	Gltscr2-RP23-34E15.1	RP23-34E15.1	7	complement(15937838..15946...	Gltscr2	27
1	complement(4687934..4689...	RP23-34E15.1-Gltscr2	RP23-34E15.1	7	complement(15937838..15946...	Gltscr2	20
1	complement(4773206..4785...	Mpl15-Trim30a	Mpl15	7	complement(104409025..1044...	Trim30a	6
1	4807788..4886770	Hmgb3-Lypl1	Lypl1	X	71555918..71560676	Hmgb3	10
1	4807788..4886770	Lypl1-Acat1	Lypl1	9	complement(53580522..53610...	Acat1	5
1	4807788..4886770	Lypl1-Akap12	Lypl1	10	4266329..4359468	Akap12	5
1	4807788..4886770	Lypl1-P4ha1	Lypl1	10	59323296..59373304	P4ha1	8
1	4807788..4886770	Lypl1-Tcea1	Lypl1	1	4857814..4897909	Tcea1	60
1	4807788..4886770	Lypl1-Utrn	Lypl1	10	complement(12382188..12861...	Utrn	12
1	4807788..4886770	Tcea1-Lypl1	Lypl1	1	4857814..4897909	Tcea1	78
1	4807788..4886770	Utrn-Lypl1	Lypl1	10	complement(12382188..12861...	Utrn	7
1	4857814..4897909	Hmgb3-Tcea1	Tcea1	X	71555918..71560676	Hmgb3	9
1	4857814..4897909	Lypl1-Tcea1	Tcea1	1	4807788..4886770	Lypl1	60
1	4857814..4897909	Tcea1-Hmgb3	Tcea1	X	71555918..71560676	Hmgb3	5
1	4857814..4897909	Tcea1-Lypl1	Tcea1	1	4807788..4886770	Lypl1	78
1	4857814..4897909	Tcea1-Tcea1-ps1	Tcea1	15	90882615..90883518	Tcea1-ps1	5
1	7088920..7173628	Pcmd1-Rps15a	Pcmd1	7	complement(118104378..1181...	Rps15a	333
1	7088920..7173628	Rps15a-Pcmd1	Pcmd1	7	complement(118104378..1181...	Rps15a	344
1	7177739..7179037	Ahcy-Gm9826	Gm9826	2	complement(155059310..1550...	Ahcy	7

Figure 26.19: An example of a gene fusion table.

Each row represents one gene where read pairs suggest it could be fused with another gene. This means that each fusion is represented by two rows.

The **Minimum read count** option in figure 26.10 is used to make sure that only combinations of genes supported by at least this number of read pairs are included. The default value is 5, which means that at least 5 pairs need to connect two genes in order to report it in the result.

The result table shows the following information for each row:

- **Name.** The name of the fusion (the two gene names combined).
- **Information per gene.** Gene name, chromosome and position are included for both genes.
- **Reads.** How many reads that are mapped across the two genes.

Note that the reporting of gene fusions is very simple and should be analyzed in much greater detail before any evidence of gene fusions can be verified. The table should be considered more of a pointer to genes to explore rather than evidence of gene fusions. Please note that you can include the fusion genes track in a track list together with the reads tracks to investigate the mapping patterns in greater detail:

File | New | Track List (📊)

26.2 Create Combined RNA-Seq Report

With the Create Combined RNA-Seq Report tool, you can generate an overview of several RNA-seq experiments by combining in one document several RNA-Seq reports. The description of the various sections included in the report, as well as the cutoff values that trigger warnings for sub-optimal data are the same as described for RNA-Seq reports (see section 26.1.8). The combined report can be exported in PDF or Excel format.

To start the tool:

Toolbox | RNA-Seq Analysis  **| Create Combined RNA-Seq Report**

In the wizard that opens (figure 26.20), select several RNA-seq reports and click **Next**. Note that while it seems possible to select any kind of reports in that dialog, only RNA-seq reports generated by *CLC Genomics Workbench 10.0* or higher will be compiled in the combined RNA-seq report.

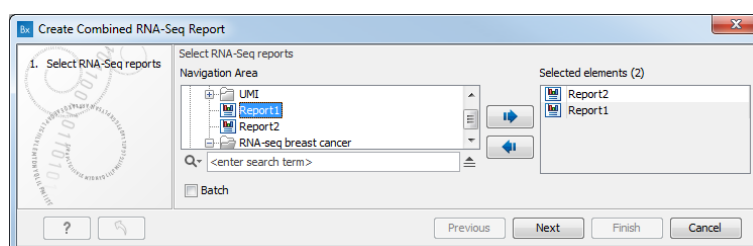

Figure 26.20: The Create Combined RNA-Seq Report tool.

In the Result handling window, choose whether you want to open or save the combined report. When saving, specify where you would like to save the combined report in the Navigation Area, and click **Finish**.

The results of the individual reports are compiled in tables, and organized in the same sections than the ones were present in the individual input reports. This layout enables a quick overview of a series of experiments as well as the different troubleshooting options for dealing with sub-optimal data quality (see figure 26.21 for an example of the first four sections of a combined report).

1 Read count statistics

Sample name	Read count	Single, mapped %	Single, unmapped %	Paired, mapped pairs %	Paired, broken pairs %	Paired, not mapped %
Report2	1,000,000	N/A	N/A	39.98	3.69	N/A
Report1	2,758,262	N/A	N/A	93.21	4.13	N/A

For paired data, there are two reads in a pair.

2 Fragment counting statistics

Sample name	Mapped to genes %	Mapped to intergenic %
Report2	67.50	32.50
Report1	98.51	1.49

Default counting scheme ('Fragment counts'): An intact pair is counted as one, broken pairs are ignored.

3 Spike-in quality control

Sample name	Detected spike-ins	R ²	Reads mapped to spike-ins	% of reads mapped to spike-ins	Lower limit of detection (attomoles/μL)
Report2	46/92	0.05	7,336	3.10	0.03
Report1	54/92	0.97	24,667	1.76	7.32

R²: The sample has poor correlation (R² < 0.8) between known and measured spike-in concentrations. This may indicate problems with the spike-in protocol, or a more serious problem with the sample.

- Check that the correct spike-in file has been selected.
- Check the integrity of the sample RNA.

Reads mapped to spike-ins: Fewer than 10000 reads mapped to spike-ins.

- Check that the correct spike-in sequences are specified.
- Consider using more spike-in mix in future experiments.

4 Strand specificity

Sample name	Strand specific setting	Forward % of reads mapped	Reverse % of reads mapped	Ignored reads (wrong strand)	Ignored reads % (wrong strand)
Report2	Both	50.50	49.50	0	0.00
Report1	Both	96.01	3.99	1,644	0.06

Strand specific setting: >90% of reads were mapped in the same orientation. Consider re-running the tool with a strand specific setting ("Forward"/"Reverse").

Figure 26.21: An example combined report.

26.3 Advanced RNA-Seq Tools

The tools from the Advanced RNA-Seq plugin have been moved into CLC Genomics Workbench and Biomedical Genomics Workbench in March 2017. They can be found in the new "RNA-Seq Analysis" section of the toolbox.

The new tools are:

- **PCA for RNA-Seq** clusters samples in 2D or 3D. Known metadata about each sample is added as an overlay.
- **Differential Expression for RNA-Seq** uses multi-factorial statistics based on a negative binomial GLM. The tool supports paired designs and can control for batch effects.
- **Create Heat Map for RNA-Seq** simultaneously clusters samples and features. Known metadata about each sample is added as an overlay.

- **Create Expression Browser** allows expression values, statistical results, and gene annotations to be viewed together.
- **Create Venn Diagram for RNA-Seq** shows differentially expressed genes shared between experimental conditions.

The Advanced RNA-seq tools require RNA-Seq input data in the form of Expression Tracks, unlike the tools included in the "Microarray and Small RNA" folder that also support microarray data or Experiment objects.

In addition, the tools from the RNA-Seq folder automatically account for differences due to sequencing depth, removing the need to normalize input data.

Finally, the statistical analysis and visualization tools of the RNA-Seq folder make extensive use of the metadata system.

26.3.1 Expression tracks expression values

Expression Tracks can be created using the RNA-Seq Analysis tool with a choice of possible expression values:

- **RPKM** This is the expression value measured in RPKM [Mortazavi et al., 2008]:
$$\text{RPKM} = \frac{\text{total exon reads}}{\text{mapped reads(millions)} \times \text{exon length (KB)}}$$
- **TPM** (Transcripts Per Million) This is computed as $\frac{\text{RPKM} \cdot 10^6}{\sum \text{RPKM}}$, where the sum is over the RPKM values of all genes/transcripts (see <http://bioinformatics.oxfordjournals.org/content/26/4/493.long>)
- **Total counts** This is all the reads that are mapped to this gene - both reads that map uniquely to the gene or its transcripts and reads that matched to more positions in the reference which were assigned to this gene.
- **Unique counts** This is the number of reads that match uniquely to the gene or its transcripts.

The choice of expression value only affects how Expression Tracks are visualized in the track view but the results will not be affected by this choice as the most appropriate expression value is automatically selected for the analysis being performed: for detection of differential expression this is the "Total counts" value, and for the other tools this is a normalized and transformed version of the "Total counts" as described below.

26.3.2 TMM Normalization

Since the sequencing depth might differ between samples, a per-sample library size normalization must be performed before samples can be compared. In the case of the tools included in the RNA-Seq folder, this normalization is automatically applied by the tools.

All of the tools in the RNA-Seq folder use the TMM (trimmed mean of M values) normalization method [Robinson and Oshlack, 2010] to calculate effective libraries sizes, which are then used as part of the per-sample normalization. TMM normalization is the normalization used in EdgeR [Robinson et al., 2010].

TMM normalization adjusts library sizes based on the assumption that most genes are not differentially expressed. Therefore, it is important not to make subsets of the count data before doing statistical analysis or visualization, as this can lead to differences being normalized away.

For the expression visualization tools (Create Heat Map and PCA for RNA-Seq) additional filtering and normalization are performed:

- 'log CPM' (Counts per Million) values are calculated for each gene. The CPM calculation uses the effective library sizes as calculated by the TMM normalization.
- After this first normalization, a second one is performed across samples for each gene: the counts for each gene are mean centered, and scaled to unit variance.
- Genes or transcripts with zero expression across all samples or invalid values (NaN or +/- Infinity) are removed.

26.3.3 Metadata

The statistical analysis and visualization tools of the RNA-Seq folder make extensive use of the metadata system. For example, metadata are required when defining the experimental design in the Differential Expression for RNA-Seq tool, and can be used to add extra layers of insight in the Create Heat Map and PCA for RNA-Seq tools.

To get the most out of these tools we recommend that all input expression tracks have associated metadata, as shown in figure 26.22. For information about how to use and setup metadata, please see section 3.2.

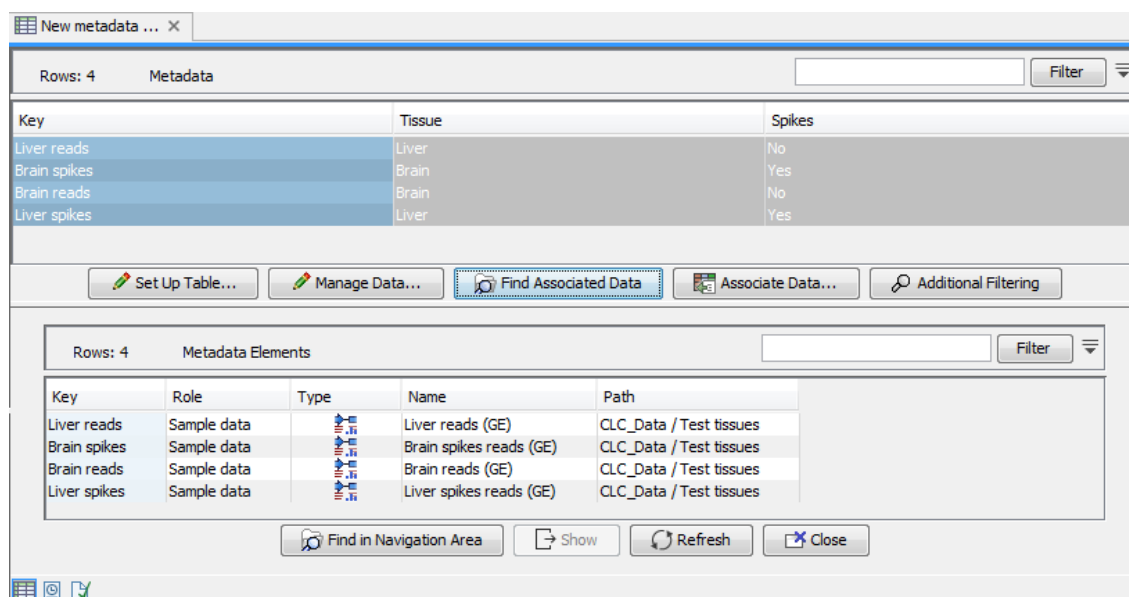

Figure 26.22: An example of expression tracks with associated metadata.

26.4 PCA for RNA-Seq

Principal Component Analysis makes it possible to project a high-dimensional dataset (where the number of dimensions equals the number of genes or transcripts) onto two or three dimensions.

This helps in identifying outlying samples for quality control, and gives a feeling for the principal causes of variation in a dataset. The analysis proceeds by transforming a large set of variables (in this case, the counts for each individual gene or transcript) to a smaller set of orthogonal principal components. The first principal component specifies the direction with the largest variability in the data, the second component is the direction with the second largest variation, and so on.

To start the analysis:

Toolbox | RNA-Seq Analysis | PCA for RNA-Seq

Select a number of expression tracks  and click **Next**.

26.4.1 Principal component analysis plot (2D)

The default view is a two-dimensional principal component plot as shown in figure 26.23.

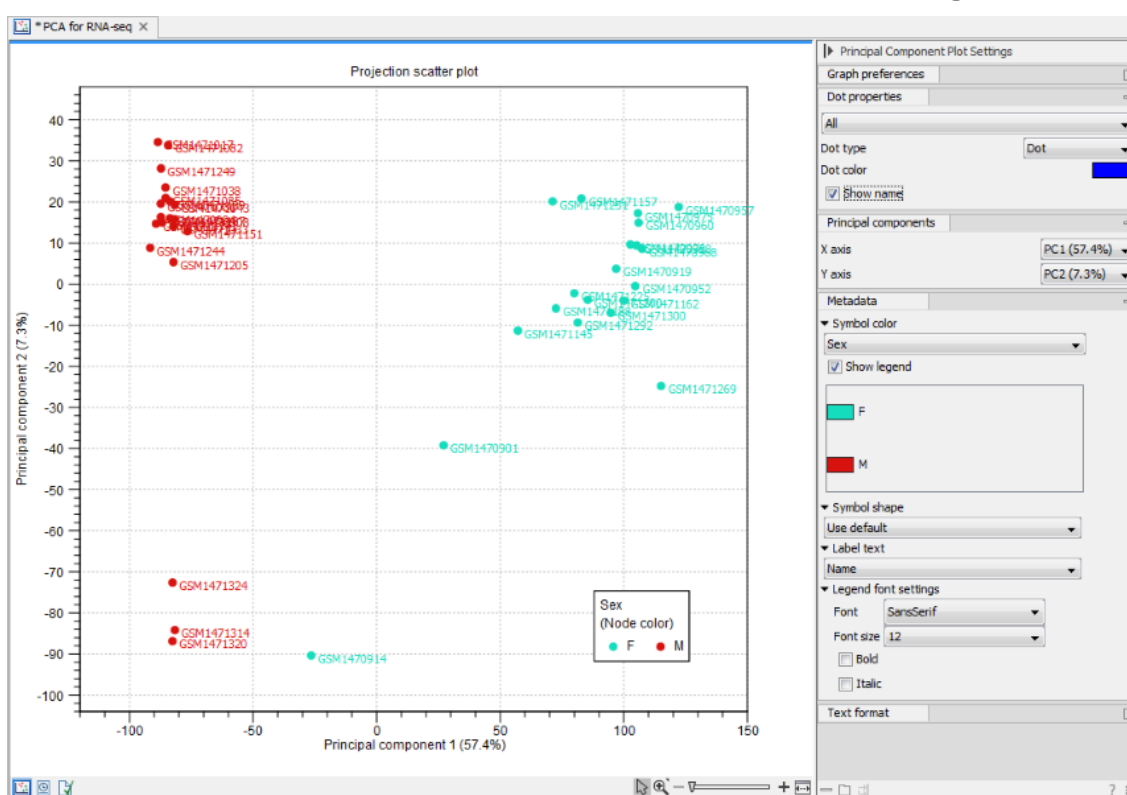

Figure 26.23: A principal component plot.

The plot shows the projection of the samples onto the two-dimensional space spanned by the first and second principal components of the covariance matrix. The expression levels used as input are normalized log CPM values, see section 26.3.

The view settings can be adjusted using the **Side Panel**. Under **Graph preferences**, you can adjust the general properties of the plot.

- **Lock axes** This will always show the axes even though the plot is zoomed to a detailed level.
- **Frame** Shows a frame around the graph.

- **Tick type** Determines whether tick lines should be shown outside or inside the frame.
- **Tick lines at** Choosing Major ticks will show a grid behind the graph.
- **Horizontal axis range** Sets the range of the horizontal axis (x axis). Enter a value in **Min** and **Max**, and press Enter. This will update the view. If you wait a few seconds without pressing Enter, the view will also be updated.
- **Vertical axis range** Sets the range of the vertical axis (y axis). Enter a value in **Min** and **Max**, and press Enter. This will update the view. If you wait a few seconds without pressing Enter, the view will also be updated.
- **y = 0 axis** Draws a line where $y = 0$ with options for adjusting the line appearance.

Below the general preferences, you find the **Dot properties**:

- **Drop down menu** In this you select the expression tracks to which following choices apply.
- **Dot type** Allows you to choose between different dot types.
- **Dot color** Click the color box to select a color.
- **Show name** This will show a label with the name of the sample next to the dot.

Note that the Dot properties may be overridden when the Metadata options are used to control the visual appearance (see below).

The **Principal Components** group determines which two principal components are used in the 2D plot. By default, the first principal component is shown for the X axis and the second principal component is shown for the Y axis. The value after the principal component identifier (for example "PC1 (72.5 %)") displays the amount of variance explained by this particular principal component.

The **Metadata** group allows metadata associated with the Expression tracks to be visualized in a number of ways:

- **Symbol color** Colors are assigned based on a categorical factor in the metadata table.
- **Symbol shape** Shape is assigned based on a categorical factor in the metadata table.
- **Label text** Dots are labeled according to the values in a given metadata column.
- **Legend font settings** contains options to adjust the display of labels.

The graph and axes titles can be edited simply by clicking them with the mouse. These changes will be saved when you **Save** () the graph - whereas the changes in the **Side Panel** need to be saved explicitly (see section 4.6.1).

26.4.2 Principal component analysis plot (3D)

The principal component plot may also be displayed in 3D. The 3D view is accessible through the view buttons at the bottom of the panel.

Notice that the 3D PCA rendering feature requires a graphics card capable of supporting OpenGL 2.0. Please make sure the latest driver for the graphics card is installed. Indirect rendering (such as x11 forwarding through ssh), remote desktop connection/VNC, and running in virtual machines is not supported.

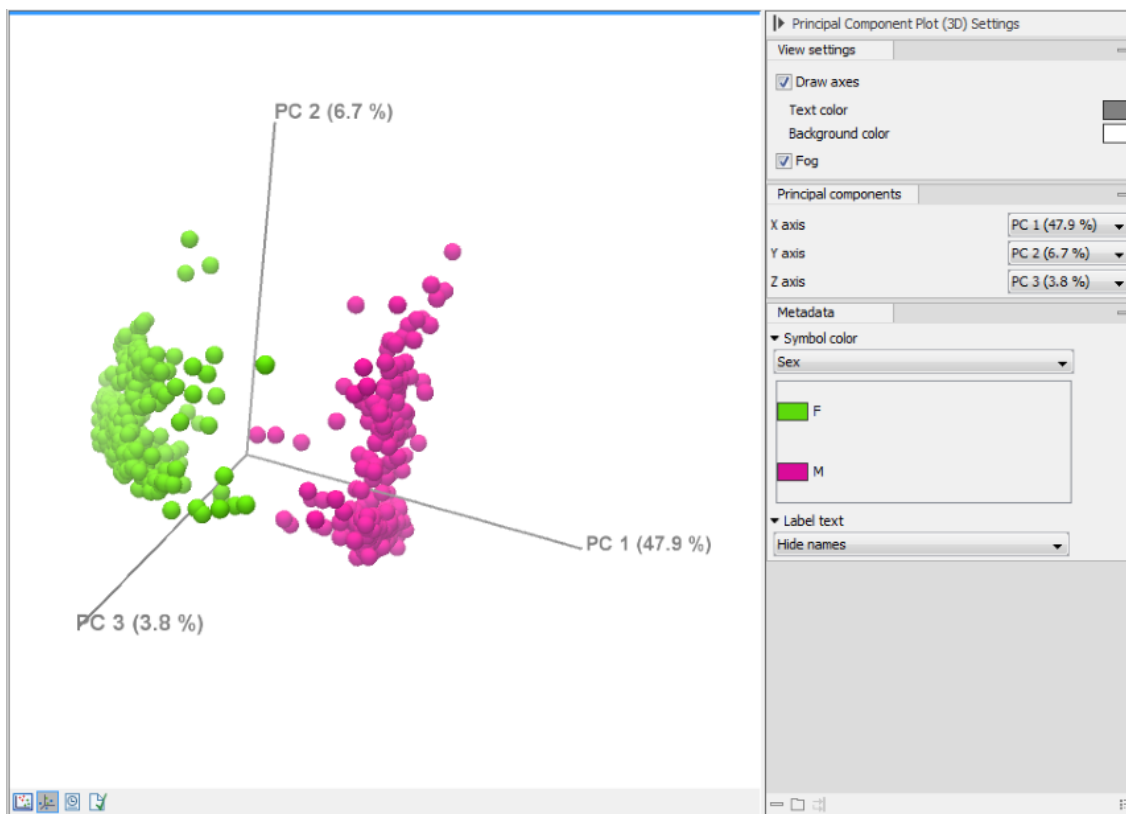

Figure 26.24: A principal component 3D plot.

The 3D view may be rotated by dragging on the view with the left mouse button pressed. It is possible to pan the view by dragging with the right mouse button pressed. Zooming can be done either using the mouse scroll wheel, or by dragging with both left and right mouse button pressed. It is also possible to center and zoom to a sample simply by clicking on it. Clicking outside any sample (or clicking with the right mouse button) restores the zoom and centering.

The **Side Panel** offers a number of options to change the appearance of the 3D principal component plot:

The **View settings** group makes it possible to toggle the coordinate system on and off, and adjust the text and background color. It is also possible to enable **Fog**, which dims distant objects in order to improve the depth perception.

The **Principal Components** group determines which principal components are used in the 3D plot. The value after the principal component identifier (for example "PC 1 (72.5 %)") displays the amount of variance explained by this particular principal component.

The **Metadata** group allows metadata associated with the Expression tracks to be visualized using color or as text:

- **Symbol color** Colors are assigned based on a categorical factor in the metadata table.

- **Label text** Samples are labeled according to the values in a given metadata column. If 'Show names' is selected, the samples will be labeled according to their name (as shown in the **Navigation Area**).

To save the current view as an image, press the **Graphics** button in the Workbench toolbar. Next, select the location where you wish to save the image, select file format (PNG, JPEG, or TIFF), and provide a name, if you wish to use another name than the default name.

It is possible to save the current view settings (including camera settings) using the **Side Panel** view settings options, see section 4.6.1.

26.5 Differential Expression for RNA-Seq

The **Differential Expression for RNA-Seq** tool performs a statistical differential expression test for a set of Expression Tracks. The statistical analysis is described in more detail in section 26.5.1.

To run the Differential Expression for RNA-Seq analysis:

Toolbox | RNA-Seq Analysis | Differential Expression for RNA-Seq

Select a number of Expression tracks (📄) and click **Next**.

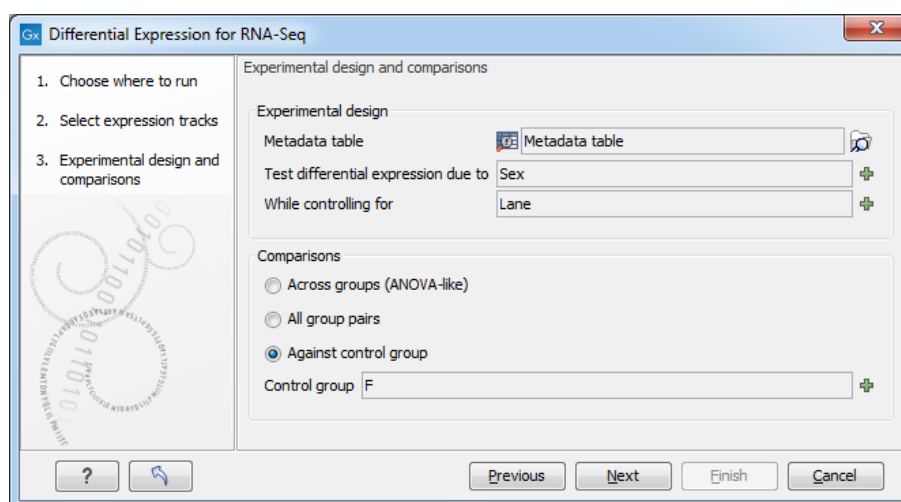

Figure 26.25: Setting up the experimental design and comparisons.

This will display the wizard shown in figure 26.25.

In the **Experimental design** panel, a Metadata table must be selected that describes the factors and groups for all the samples.

- **Metadata table** The metadata table describing the factors for the selected Expression tracks.
- **Test differential expression due to** Specify the one factor differential expression is tested for.
- **While controlling for** Specify confounding factors, i.e., factors that are not of primary interest, but may affect gene expression.

The **Comparisons** panel determines the number and type of statistical comparison tracks output by the tool (see section 26.5.2 for more details).

How many replicates do I need? The Differential Expression for RNA-Seq tool is capable of running without replicates, but this is not recommended and the results should be treated with caution. In general it is desirable to have as many biological replicates as possible – typically at least 3. Replication is important in that it allows the ‘within group’ variation to be accurately estimated for a gene. In the absence of replication, the Differential Expression for RNA-Seq tool assumes that genes with similar average expression levels have similar variability.

Technical or biological replicates? [Auer and Doerge, 2010] illustrates the importance of *biological replicates* with the example of an alien visiting Earth. The alien wishes to know if men are taller than women. It abducts one man and one woman, and measures their heights several times i.e. performs several *technical replicates*. However, in the absence of *biological replicates*, the alien would erroneously conclude that women are taller than men if this was the case in the two abducted individuals.

26.5.1 The statistical model

Each gene is modeled by a separate Generalized Linear Model (GLM). The use of the GLM formalism allows us to fit curves to expression values without assuming that the error on the values is normally distributed. Similarly to EdgeR and DESeq, we assume that the read counts follow a Negative Binomial distribution.

The Negative Binomial distribution can be understood as a ‘Gamma-Poisson’ mixture distribution i.e. the distribution resulting from a mixture of Poisson distributions, where the Poisson parameter λ is itself Gamma-distributed. In an RNA-Seq context, this Gamma distribution is controlled by the **dispersion** parameter, such that the Negative Binomial distribution reduces to a Poisson distribution when the dispersion is zero.

Fitting a GLM to expression data

It is easiest to understand how the GLM model works through an example. Imagine an experiment looking at the effect of two drug treatments while controlling for the gender of a patient:

- **Test differential expression due to** Treatment with three groups: drugA, drugB, placebo
- **While controlling for** Gender with groups: Male, Female

In an abuse of mathematical notation, the underlying GLM for each gene looks like

$$\log y_i = (\text{placebo and Male}) + \text{drugA} + \text{drugB} + \text{Female} + \text{constant}_i \quad (26.1)$$

where y_i is the expression level for the gene in sample i ; the combined term (placebo and Male) describes an arbitrarily chosen baseline expression level (of males being given a placebo); and the other terms drugA, drugB and Female are numbers describing the effect of each group

with respect to this baseline. The constant_i accounts for differences in the library size between samples. For example, if a patient is male and given a placebo we predict the expression level to be

$$\log y_i = (\text{placebo and Male}) + \text{constant}_i.$$

If instead he had been given drug B, we would predict the expression level y_i to be augmented with the drugB coefficient, resulting in

$$\log y_i = (\text{placebo and Male}) + \text{drugB} + \text{constant}_i.$$

We assume that the expression levels y_i follow a Negative Binomial distribution. This distribution has a free parameter, the dispersion. The greater the dispersion, the greater the variation in expression levels for a gene.

The most likely values of the dispersion and coefficients, drugA, drugB and Female, are determined simultaneously by fitting the GLM to the data. To see why this simultaneous fitting is necessary, imagine an experiment where we observe counts {3,10,4} for Males and {30,20,8} for Females. The most natural fit is for the coefficient Female to have a two-fold change and for the dispersion to be small, but an alternative fit has no fold change and a larger dispersion. Under this second fit the variation in the counts is greater, and it is just by chance that all three Female values are larger than all three Male values.

Refining the estimate of dispersion

Much research has gone into refining the dispersion estimates of GLM fits. One important observation is that the GLM dispersion for a gene is often too low, because it is a *sample* dispersion rather than a *population* dispersion. We correct for this using the Cox-Reid adjusted likelihood, as in the multi-factorial EdgeR method [Robinson et al., 2010].²

A second observation that can be used to improve the dispersion estimate, is that genes with the same average expression often have similar dispersions. To make use of this observation, we follow [Robinson et al., 2010] in estimating genewise dispersions from a linear combination of the likelihood for the gene of interest and neighboring genes with similar average expression levels. The weighting in this combination depends on the number of samples in an experiment, such that the neighbors have most weight when there are no replicates, and little effect when the number of replicates is high.

Statistical testing

The final GLM fit and dispersion estimate allows us to calculate the total likelihood of the model given the data, and the uncertainty on each fitted coefficient. The two statistical tests each make use of one of these values.

Wald test Tests whether a given coefficient is non-zero. This test is used in the **All group pairs** and **Against control group** comparisons. For example, to test whether there is a difference

²To understand the purpose of the correction, it may help to consider the analogous situation of calculation of the variance of normally distributed measurements. One approach would be to calculate $\frac{1}{n} \sum (x_i - \bar{x})^2$, but this is the *sample* variance and often too low. A commonly used correction for the *population* variance is: $\frac{1}{n-1} \sum (x_i - \bar{x})^2$.

between patients treated with a placebo, and those treated with drugB, we would use the Wald test to determine if the drugB coefficient is non-zero.

Likelihood Ratio test Fits two GLMs, one with the given coefficients and one without. The more important the coefficients are, the greater the ratio of the likelihoods of the two models. This test is used in the Across groups (ANOVA-like) comparison. If we wanted to test whether either drug had an effect, we would compare the likelihoods of the GLM described in equation 26.1 with those in the reduced GLM $\log y_i = (\text{Male}) + \text{Female} + \text{constant}_i$.

26.5.2 Output of the Differential Expression for RNA-Seq tool

The Differential Expression for RNA-Seq tool produces different numbers and types of statistical comparison tracks depending on the settings of the **Comparisons** panel. Depending on the choice either a Wald test or a Likelihood Ratio test is used. For example, assume that we test a factor called 'Tissue' with three groups: skin, liver, brain.

- **Across groups (ANOVA-like)** This mode tests for the effect of a factor across all groups.
 - *Outputs produced:* "Due to Tissue"
 - *Test used:* Likelihood ratio test
 - *Fold change reports:* The maximum pairwise fold change between any two of the three tissue types.
 - *Max of group means reports:* The maximum of the average group RPKM values among any of the tissue types for a gene.
- **All group pairs** tests for differences between all pairs of groups in a factor.
 - *Outputs produced:* "skin vs. liver", "skin vs. brain", "liver vs. brain"
 - *Test used:* Wald test
 - *Fold change reports:* The fold change in the defined order between the named pair of tissue types.
 - *Max of group means reports:* The maximum of the average group RPKM values between the two named tissue types.
- **Against control group** This mode tests for differences between all the groups in a factor and the named reference group. In this example the reference group is skin.
 - *Outputs produced:* "liver vs. skin", "brain vs. skin"
 - *Test used:* Wald test
 - *Fold change reports:* The fold change in the defined order between the named pair of tissue types.
 - *Max of group means reports:* The maximum of the average group RPKM values between the two named tissue types.

Note: Fold changes are calculated from the GLM, which corrects for differences in library size between the samples and the effects of confounding factors. It is therefore not possible to derive these fold changes from the original counts by simple algebraic calculations.

26.5.3 Statistical comparison tracks

The Differential Expression for RNA-Seq tool will output one or more statistical comparison tracks.

An example of a statistical comparison track is shown in figure 26.26. Statistical comparison tracks make it possible to show differential expression data alongside other kinds of tracks in a genomic context.

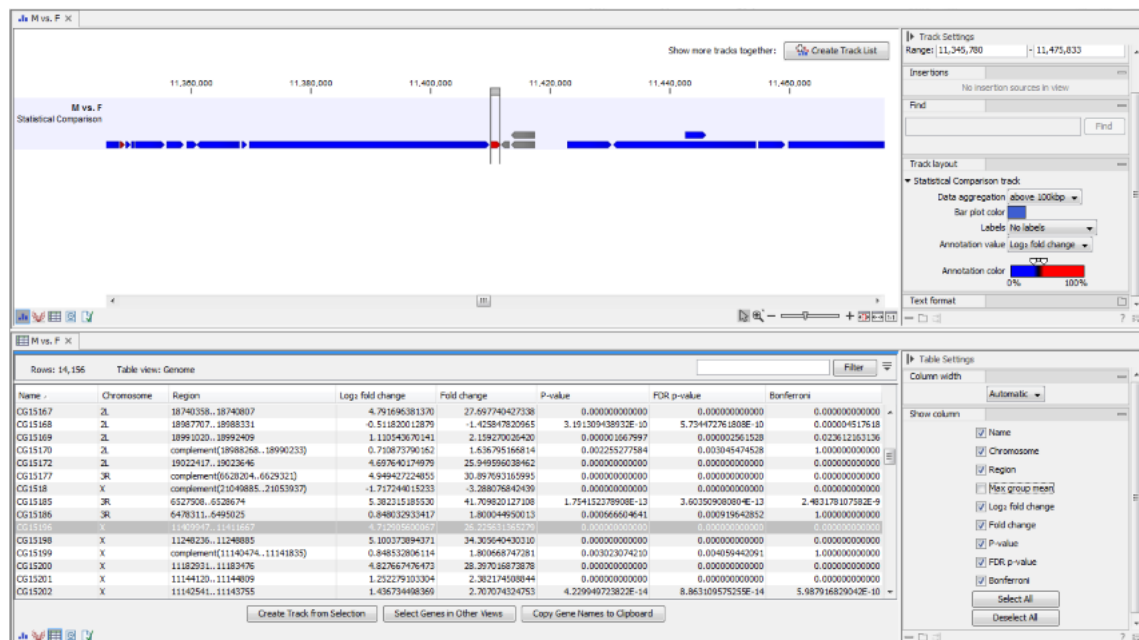

Figure 26.26: Statistical comparison track view.

The track layout of the statistical comparison track can be customized as follows:

- **Data aggregation** Allows you to specify whether the information in the track should be shown in detail or whether you wish to aggregate data. By aggregating data you decrease the detail level, but increase the speed of the data display process, which is of particular interest when working with big data sets. The threshold (in bp) for when data should be aggregated can be specified with the drop-down box. The threshold describes the unit (or "bucket") size in base pairs, above which the data will start being aggregated. The bucket size depends on the track length and the zoom level. Hence, a data aggregation threshold with a low value will only show details when zoomed in, whereas a high value means that you can see details even when zoomed out. Please note that when using the high values, it will take longer time to display the data on the screen.
- **Bar plot color** Selects the color of aggregated data.
- **Labels** Determines where the gene name should be shown.
- **Annotation value** The value that is graphically shown in detail view:
 - **Max group means** For each group in the statistical comparison, the average RPKM is calculated. This value is the maximum of the average RPKM's.
 - **Log₂ fold change** The logarithmic fold change.

- **Fold change** The (signed) fold change. Genes/transcripts that are not observed in any sample have undefined fold changes and are reported as NaN (not a number).
 - **P-value** Standard p-value. Genes/transcripts that are not observed in any sample have undefined p-values and are reported as NaN (not a number).
 - **FDR p-value** The false discovery rate corrected p-value.
 - **Bonferroni** The Bonferroni corrected p-value.
- **Annotation color** Determines how the annotation value is mapped onto a color.

The expression track table view has three buttons.

- The "Create track from Selection" will create a Track using selected rows.
- The "Select Genes in Other Views" button finds and selects the currently selected genes and transcripts in all other open expression track table views.
- The "Copy Gene Names to Clipboard" button copies the currently selected gene names to the clipboard.

26.5.4 The volcano plot

Statistical comparison tracks also offer a volcano plot view.

An example of a volcano plot is shown in figure 27.70.

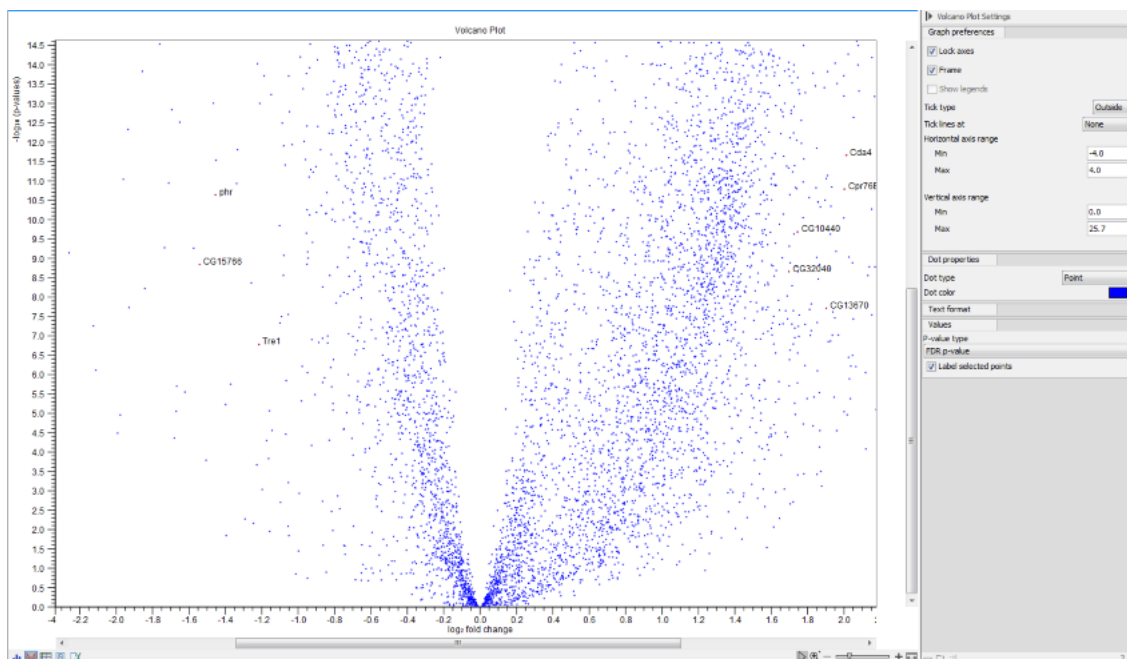

Figure 26.27: Volcano plot.

The volcano plot shows the relationship between the p-values of a statistical test and the fold changes among the samples. The \log_2 fold changes are plotted on the x-axis, and the $-\log_{10}$ p-values are plotted on the y-axis. Features of interest are typically those in the upper left and right hand corners of the volcano plot, as these have large fold changes (lie far from $x = 0$) and

are statistically significant (have large y-values). It is possible to change the type of p-value from the side panel (see below).

The view settings can be adjusted using the **Side Panel**. Under **Graph preferences**, you can adjust the general properties of the volcano plot

- **Lock axes** This will always show the axes even though the plot is zoomed to a detailed level.
- **Frame** Shows a frame around the graph.
- **Show legends** Shows the data legends.
- **Tick type** Determine whether tick lines should be shown outside or inside the frame.
 - Outside
 - Inside
- **Tick lines at** Choosing Major ticks will show a grid behind the graph.
 - None
 - Major ticks
- **Horizontal axis range** Sets the range of the horizontal axis (x axis). Enter a value in **Min** and **Max**, and press Enter. This will update the view. If you wait a few seconds without pressing Enter, the view will also be updated.
- **Vertical axis range** Sets the range of the vertical axis (y axis). Enter a value in **Min** and **Max**, and press Enter. This will update the view. If you wait a few seconds without pressing Enter, the view will also be updated.

Below the general preferences, you find the **Dot properties** and **Text format**, where you can adjust the coloring and appearance of the dots and text.

At the bottom are options for choosing which values to display:

- **P-value type** Selects which type of p-value to use.
- **Label selected points** Chooses whether selected points should be labeled.

Note that if you wish to use the same settings next time you open a volcano plot, you need to save the settings of the **Side Panel**.

26.6 Create Heat Map for RNA-Seq

The **Create Heat Map** tool shows a two dimensional heat map of expression values. Each column corresponds to one sample, and each row corresponds to a feature (a gene or a transcript). The samples and features are both hierarchically clustered.

26.6.1 Clustering of features and samples

The hierarchical clustering clusters features by the similarity of their expression profiles over the set of samples. It clusters samples by the similarity of expression patterns over their features.

Each clustering has a tree structure that is generated by

1. Letting each feature or sample be a cluster.
2. Calculating pairwise distances between all clusters.
3. Joining the two closest clusters into one new cluster.
4. Iterating 2-3 until there is only one cluster left (which contains all the features or samples).

The tree is drawn so that the distances between clusters are reflected by the lengths of the branches in the tree.

To create a heat map:

Toolbox | RNA-Seq Analysis | Create Heat Map for RNA-Seq (🔍)

Select at least two expression tracks (🔍) and click **Next**.

This will display the wizard shown in figure 26.28. The hierarchical clustering algorithm requires that you specify a distance measure and a cluster linkage. The distance measure is used to specify how distances between two features or samples should be calculated. The cluster linkage specifies how the distance between two clusters, each consisting of a number of features or samples, should be calculated.

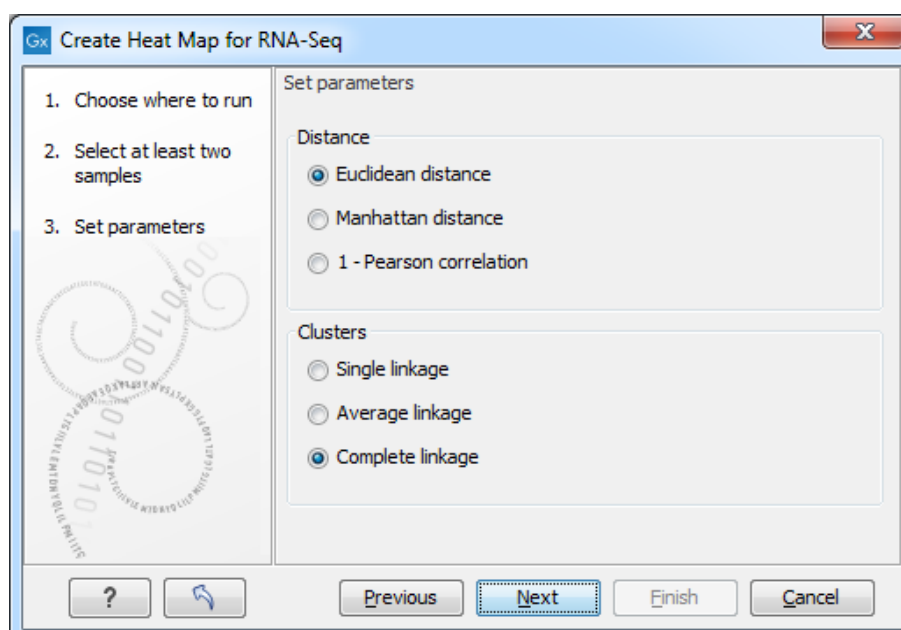

Figure 26.28: Parameters for Create Heat Map.

There are three kinds of **Distance measures**:

- **Euclidean distance** The ordinary distance between two points - the length of the segment connecting them. If $u = (u_1, u_2, \dots, u_n)$ and $v = (v_1, v_2, \dots, v_n)$, then the Euclidean

distance between u and v is

$$|u - v| = \sqrt{\sum_{i=1}^n (u_i - v_i)^2}.$$

- **Manhattan distance** The Manhattan distance between two points is the distance measured along axes at right angles. If $u = (u_1, u_2, \dots, u_n)$ and $v = (v_1, v_2, \dots, v_n)$, then the Manhattan distance between u and v is

$$|u - v| = \sum_{i=1}^n |u_i - v_i|.$$

- **1 - Pearson correlation** The Pearson correlation coefficient between two elements $x = (x_1, x_2, \dots, x_n)$ and $y = (y_1, y_2, \dots, y_n)$ is defined as

$$r = \frac{1}{n-1} \sum_{i=1}^n \left(\frac{x_i - \bar{x}}{s_x} \right) \left(\frac{y_i - \bar{y}}{s_y} \right)$$

where \bar{x}/\bar{y} is the average of values in x/y and s_x/s_y is the sample standard deviation of these values. It takes a value $\in [-1, 1]$. Highly correlated elements have a high absolute value of the Pearson correlation, and elements whose values are un-informative about each other have Pearson correlation 0. Using $1 - |\text{Pearsoncorrelation}|$ as distance measure means that elements that are highly correlated will have a short distance between them, and elements that have low correlation will be more distant from each other.

The possible cluster linkages are:

- **Single linkage** The distance between two clusters is computed as the distance between the two closest elements in the two clusters.
- **Average linkage** The distance between two clusters is computed as the average distance between objects from the first cluster and objects from the second cluster. The averaging is performed over all pairs (x, y) , where x is an object from the first cluster and y is an object from the second cluster.
- **Complete linkage** The distance between two clusters is computed as the maximal object-to-object distance $d(x_i, y_j)$, where x_i comes from the first cluster, and y_j comes from the second cluster. In other words, the distance between two clusters is computed as the distance between the two farthest objects in the two clusters.

After having selected the distance measure, click **Next** to set up the feature filtering options as shown in figure 26.29.

Genomes usually contain too many features to allow for a meaningful visualization of all genes or transcripts. Clustering hundreds of thousands of features is also very time consuming. Therefore it is recommend to reduce the number of features before clustering and visualization.

There are several different **Filter settings** to filter genes or transcripts:

- **No filtering** Keeps all features.

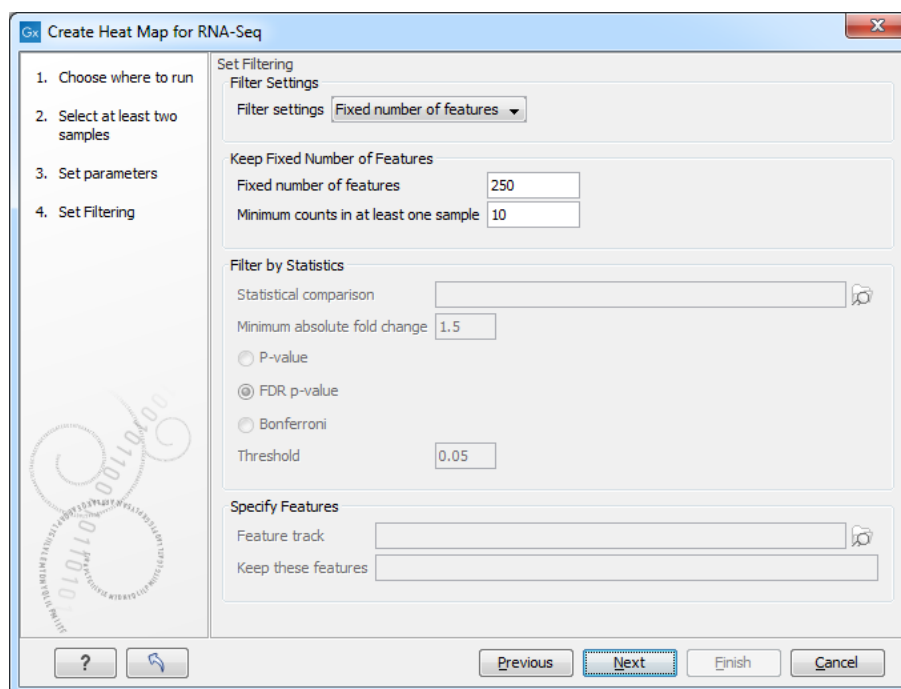

Figure 26.29: Feature filtering for Create Heat Map.

- **Fixed number of features**
 - **Fixed number of features** The given number of features with the highest coefficient of variation (the ratio of the standard deviation to the mean) are kept.
 - **Minimum counts in at least one sample** Only features with more than this number of counts in at least one sample will be taken into account. Notice that the counts are raw, un-normalized values.
- **Filter by statistics** Keeps features that are differentially expressed according to the specified cut-offs.
 - **Statistical comparison** A single statistical comparison track output by the Differential Expression for RNA-Seq tool.
 - **Minimum absolute fold change** Only features with a higher absolute fold change are kept.
 - **Threshold** Only features with a lower p-value are kept. It is possible to select which type of p-value to use.
- **Specify features** Keeps a set of features, as specified by either a feature track or by plain text.
 - **Feature track** Any genes or transcripts defined in the feature track will be kept.
 - **Keep these features** A plain text list of feature names. Any white-space characters, and ",", and ";" are accepted as separators.

26.6.2 The heat map view

After the tool completes, a heat map like the one shown in (figure 26.30) is produced. In the heat map each row corresponds to a feature and each column to a sample. The color in the i 'th row

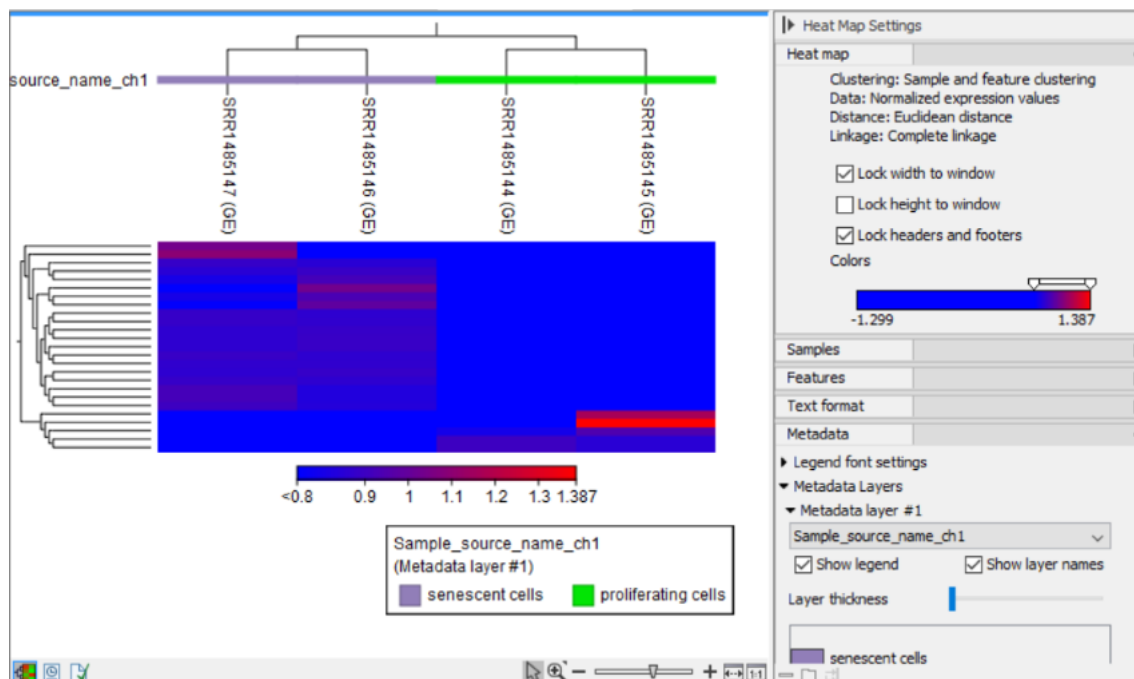

Figure 26.30: The 2D heat map.

and j 'th column reflects the expression level of feature i in sample j (the color scale can be set in the side panel). The expression values used are normalized log CPM values, see section 26.3.

There are a number of options to change the appearance of the heat map. At the top of the **Side Panel**, you find the **Heat map** group (see figure 26.30).

- **Lock width to window** When you zoom in the heat map, you will per default only zoom in on the vertical level. This is because the width of the heat map is locked to the window. If you uncheck this option, you will zoom both vertically and horizontally. Since you normally have more features than samples, it is useful to lock the width since you then have all the samples in view all the time.
- **Lock height to window** This is the corresponding option for the height. Note that if you check both options, you will not be able to zoom at all, since both the width and the height are fixed.
- **Lock headers and footers** This will ensure that you are always able to see the sample and feature names and the trees when you zoom in.
- **Colors** The expression levels are visualized using a gradient color scheme, where the right side color is used for high expression levels and the left side color is used for low expression levels. You can change the coloring by clicking the box, and you can change the relative coloring of the values by dragging the two knobs on the white slider above.

Below you find the **Samples** and **Features** groups. They contain options to show names, color legends, and trees above or below the heat map. The tree options also control the **Tree size**, including the option of showing the full tree, no matter how much space it will use.

The **Metadata** group makes it possible to visualize metadata associated with the Expression tracks:

- **Legend font settings** adjusts the label settings.
- **Metadata layers** Adds a color bar to the hierarchical sample tree, colored according to the value of a chosen metadata table column.

26.7 Create Expression Browser

The **Create Expression Browser** tool makes it possible to inspect gene and transcript expression level counts and statistics for many samples at the same time.

To run the tool:

Toolbox | RNA-Seq Analysis | Create Expression Browser

Select a number of expression tracks (), either Gene level (GE) or Transcript level Expression (TE) tracks but not a combination of both, and click **Next** (see figure 26.31).

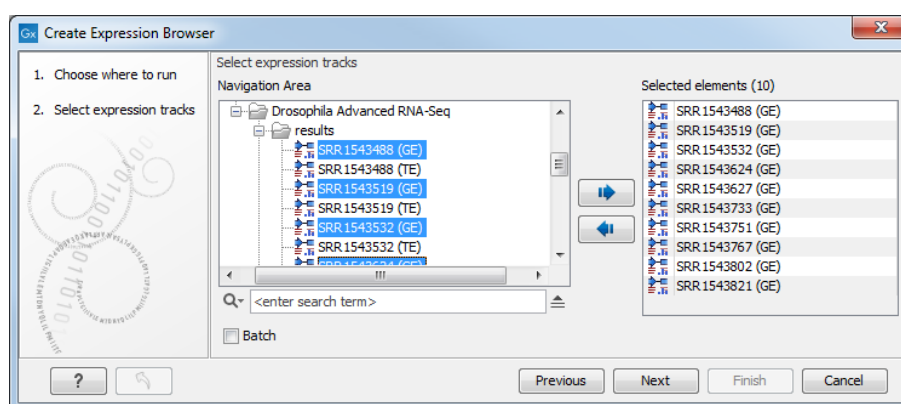

Figure 26.31: Select expression tracks, either GE or TE.

In the second wizard dialog (see figure 26.32), you can decide to add one or more statistical comparisons or an annotation source.

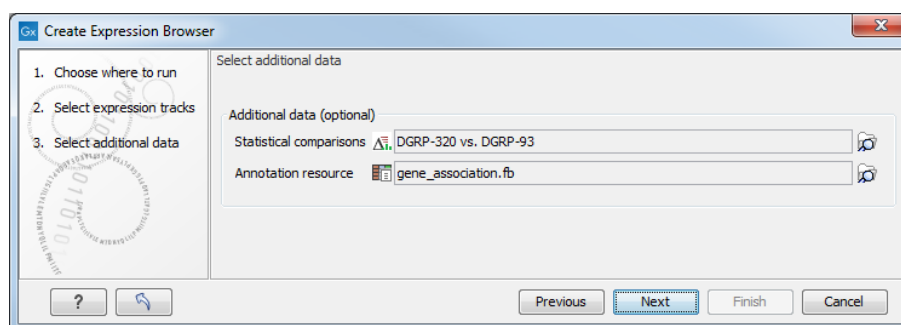

Figure 26.32: It is optional to provide statistical comparisons and annotation resources.

Statistical comparisons are generated by the Differential Expression for RNA-Seq tool. You can only choose a comparison that was generated by the same kind of expression tracks as the ones you selected in the previous step. This means that when you want to create an expression browser for GE expression levels, you can only input in the second optional step a statistical comparison generated using GE tracks as well.

Annotation resources can be obtained from different sources:

- In the majority of cases, annotations are obtained from Gene Ontology consortium at <http://geneontology.org/page/download-annotations>. Download the *.gz file of your choice from the website on to your computer, and import it in the workbench using the Standard Import tool.
- You may have your own annotation data in a spreadsheet. Learn how to import such files here: section K.5.
- Annotations can be generated by the "Blast2GO PRO" plugin (see <http://www.qiagenbioinformatics.com/plugins/blast2go-pro/> for more information).
- Some annotations for human, mouse and rat are also bundled together with Reference Data Sets provided in Biomedical Genomics Workbench.

26.7.1 The expression browser

An Expression Browser is shown in figure 26.33.

The screenshot shows the Expression Browser interface with a table of gene expression data. The table has columns for Name, Identifier, and expression values for two groups: DGRP-93 and DGRP-370. Each group has sub-columns for F and M, and further sub-columns for individual samples (SRR1543488, SRR1543627, SRR1543821, SRR1543519, SRR1543733) with Total counts and Mean values. The right panel shows the Expression Browser Table Settings, including Feature information (Name, Chromosome, Region, Identifier) and Expression values (Total counts).

Name	Identifier	DGRP-93				DGRP-370				
		F		M		S		M		
		SRR1543488...	Mean	SRR1543627...	Mean	SRR1543821...	Mean	SRR1543519...	Mean	SRR1543733...
CG30083	FBan0030083	2.00	2.00	0.00	0.00	2.00	2.00	0.00	0.00	0.00
CG30089	FBan0030089	24.00	24.00	70.00	70.00	56.00	56.00	33.00	33.00	48.00
Zesp52	FBan00355991	444.00	444.00	2,147.00	2,147.00	1,035.00	1,035.00	956.00	956.00	746.00
tun	FBan0034046	106.00	106.00	41.00	41.00	27.00	27.00	56.00	56.00	24.00
CG33465	FBan0033465	0.00	0.00	0.00	0.00	1.00	1.00	0.00	0.00	0.00
Poxn	FBan0031130	0.00	0.00	0.00	0.00	0.00	0.00	0.00	0.00	0.00
CG8249	FBan0034045	0.00	0.00	9.00	9.00	3.00	3.00	2.00	2.00	3.00
CG12970	FBan0034047	0.00	0.00	0.00	0.00	1.00	1.00	0.00	0.00	0.00
Gpo-1	FBan0022160	83.00	83.00	280.00	280.00	223.00	223.00	193.00	193.00	105.00
Rf1	FBan0030085	353.00	353.00	3.00	3.00	8.00	8.00	3.00	3.00	7.00
eil	FBan0034089	37.00	37.00	200.00	200.00	87.00	87.00	102.00	102.00	73.00
CG33463	FBan0033463	0.00	0.00	0.00	0.00	0.00	0.00	0.00	0.00	0.00
CR44373	FBan00265511	0.00	0.00	0.00	0.00	0.00	0.00	0.00	0.00	0.00
bdg	FBan0034049	84.00	84.00	101.00	101.00	117.00	117.00	102.00	102.00	63.00
Diap2	FBan0015247	94.00	94.00	97.00	97.00	113.00	113.00	119.00	119.00	47.00
CG8297	FBan0034050	19.00	19.00	20.00	20.00	29.00	29.00	32.00	32.00	6.00

Figure 26.33: Expression browser table when no statistical comparison or annotations resources were provided.

Each row represents a gene or a transcript, defined by its name, the chromosome and the region where it is located, as well as an identifier linking to the relevant online database.

The expression values for each sample - or aggregation of samples - can be given by total counts, RPKM, TPM or CPM (Counts Per Million). These measurements differ from each other in two key ways:

1. RPKM and TPM measure the number of *transcripts* whereas total counts and CPM measure the number of *reads*. The distinction is important because in an RNA-Seq experiment, more reads are typically sequenced from longer transcripts than from shorter ones.
2. RPKM, TPM and CPM are normalized for sequencing-depth so their values are *comparable* between samples. Total counts is not normalized, so values are *not comparable* between samples.

How do I get the normalized counts used to calculate fold changes? The CPM expression values are most comparable to the results of the Differential Expression for RNA-Seq tool. However, normalized counts are not used to calculate fold changes; instead the Differential Expression for RNA-Seq tool works by fitting a statistical model (which accounts for differences in sequencing-depth) to raw counts. It is therefore not possible to derive these fold changes from the CPM values by simple algebraic calculations.

It is possible to display the values for individual samples, or for groups of samples as defined by the metadata. Using the drop down menus in the "Grouping" section of the right-hand side setting panel, you can choose to group samples according to up to three metadata layers as shown in figure 26.33.

When individual samples are aggregated, an additional "summary statistic" column can be displayed to give either the mean, the minimum, or the maximum expression value for each group of samples. The table in figure 26.33 shows the mean of the expression values for the first group layer that was selected.

If one or more statistical comparisons are provided, extra columns can be displayed in the table using the "Statistical comparison" section of the Settings panel (figure 26.34). The columns correspond to the different statistical values generated by the "Differential Expression for RNA-seq" as detailed in section 26.5.3.

		DGRP-320 vs. DGRP-93								
Name	Identifier	Max group m...	Fold change	Log fold cha...	P-value	FDR p-value	Bonferoni	Database	Database identifier	Database symt
Tsp42Ec	FBgn0033124	178.41	-6.44	-2.69	1.35E-3	1.00	1.00	FB	FBgn0033124	Tsp42Ec
betaTry	FBgn0010357	3,076.23	-5.35	-2.42	1.88E-3	1.00	1.00	FB	FBgn0010357	betaTry
GstE5	FBgn0063495	79.64	13.50	3.75	1.68E-3	1.00	1.00	FB	FBgn0063495	GstE5
IM4	FBgn0040653	1,967.23	-4.14	-2.05	1.75E-3	1.00	1.00	FB	FBgn0040653	IM4
CG11400	FBgn0034198	83.33	-180.43	-7.50	1.78E-3	1.00	1.00			

Figure 26.34: Expression browser table when a statistical comparison is present.

If an annotation database is provided, extra columns can be displayed in the table using the "Annotation" section of the Settings panel (figure 26.35). Which columns are available depends on the annotation file used. When using a GO annotation file, the GO biological process column will list for each gene or transcript one or several biological processes. Click on the process name to open the corresponding page on the Consortium for Gene Ontology webpage. It is also possible to access additional online information by clicking on the the PMID, RefSeq, HGNC or UniProt accession number when available.

Select the genes of interest and use the button present at the bottom of the table to highlight the genes in other views (volcano plot for instance) or to copy the genes of interest to a clipboard.

26.8 Create Venn Diagram for RNA-Seq

The **Create Venn Diagram** tool makes it possible to compare the overlap of differentially expressed genes or transcripts in two or more statistical comparison tracks. The genes considered to be differentially expressed can be controlled by setting appropriate p-value and fold change thresholds.

To create the Venn diagram:

Toolbox | RNA-Seq Analysis | Create Venn Diagram

The screenshot shows a table with columns: Name, Identifier, Database, Database identifier, Database symbol, and a column for GO annotations. The annotations include terms like 'crotonolysis', 'defense response', 'detection of bacterium', 'innate immune response', 'nitrohydrolytic catabolic process', 'biological process', 'G1/S transition of mitotic cell cycle', 'cell cycle arrest', 'chemotaxis', 'histoblast morphogenesis', 'mitotic cell cycle', 'negative regulation of G1/S transition of mitotic cell cycle', 'open tracheal system development', 'regulation of cyclin-dependent protein kinase activity', 'regulation of protein kinase activity', 'sensory organ development', 'sensory organ precursor cell division', 'ventral cord development', 'detection of chemical stimulus', and 'DNA replication'. The right panel shows 'Expression Browser Table Settings' with various options checked, including 'Feature ID', 'Database', 'Database identifier', 'Database symbol', 'Qualifier', 'GO biological process', 'GO cellular component', 'GO molecular function', 'Database object name', 'Synonym', 'Taxon ID', 'Database object type', 'Assigned by', 'Date', 'Annotation extension', 'Gene product form ID', 'Select All', and 'Deselect All'.

Figure 26.35: Expression browser table when a GO annotation file is present.

Select a number of statistical comparison tracks () and click **Next** (see figure 26.36).

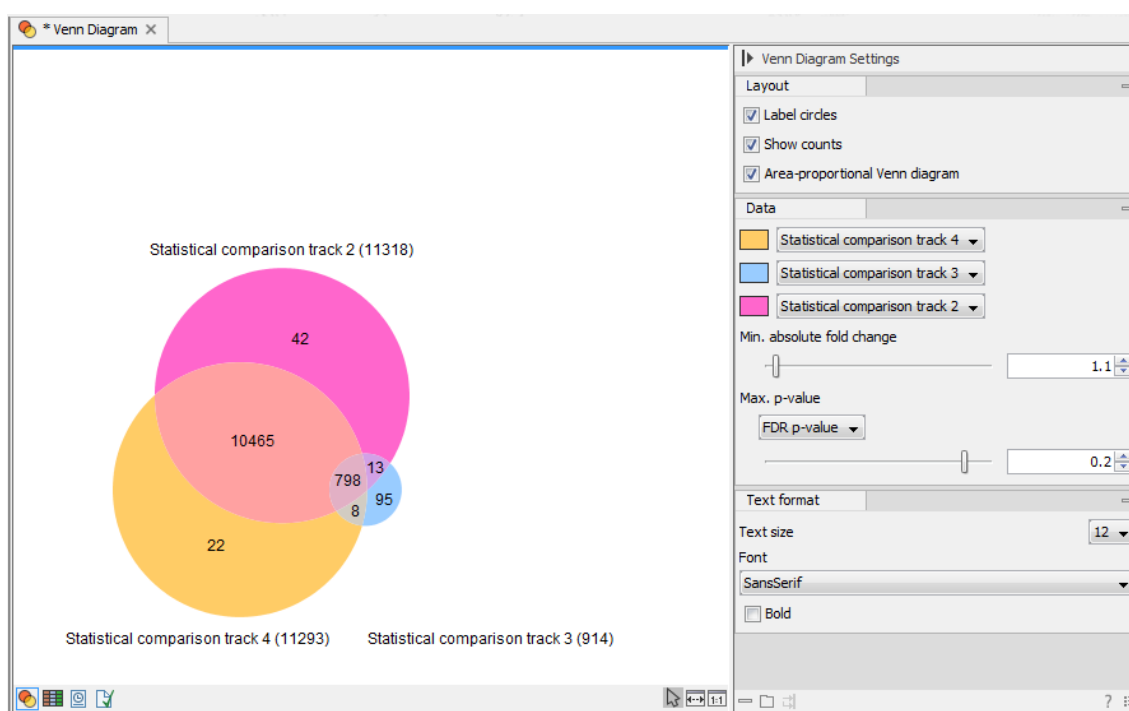

Figure 26.36: The resulting Venn diagram.

In the **Side Panel** to the right, it is possible to adjust the Venn Diagram settings. Under **Layout**, you can adjust the general properties of the plot.

- **Label circles** Toggles the names of the statistical comparison tracks.
- **Show counts** Toggles the display of gene or transcript counts.
- **Area-proportional Venn Diagram** When drawn as a Standard Venn Diagram, circles are drawn with fixed positions and identical size. When drawn in the default Venn Diagram mode, sizes and positions of the circles are adjusted in proportion to the number of overlapping features.

The **Data** side panel group makes it possible to choose the differentially expressed genes or

features of interest. The set of statistical comparisons to be compared can be selected using the drop down combo boxes at the top of the group. It is possible to customize the color of a given statistical comparison using the color picker next to the drop down combo box.

- **Minimum absolute fold change** Only genes or transcripts with an absolute fold change higher than the specified threshold are taken into account.
- **Maximum P-value** Only genes or transcripts with a p-value less than the specified threshold will be taken into account. It is possible to select which p-value measure to use.

Finally, the **Text format** group makes it possible to adjust the settings for the count and statistical comparison labels.

26.8.1 Venn diagram table view

It is possible to inspect the p-values and fold changes for each gene or transcript individually in the Venn diagram table view (see figure 26.37).

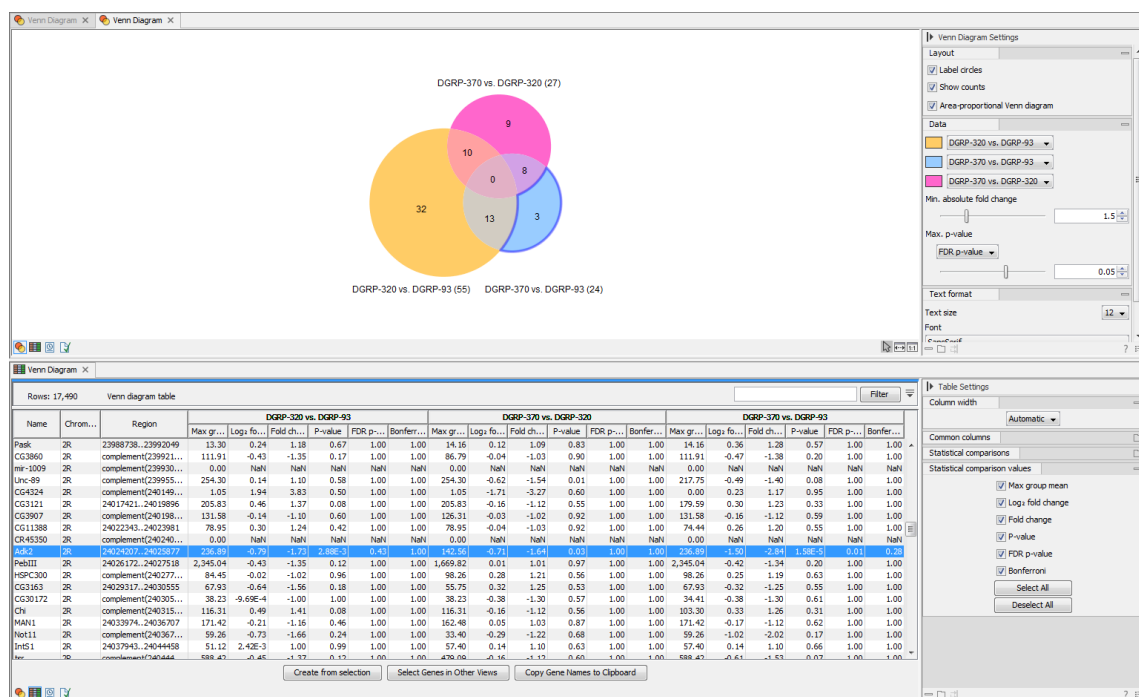

Figure 26.37: The Venn diagram table view.

Clicking a circle segment in the Venn Diagram plot will select the genes or transcript in the table view. It is also possible to create a subset list of genes or transcripts using the **Create from selection**.

In the **Side Panel** to the right it is possible to adjust the Table settings. It is possible to adjust the column layout, and select which columns should be included in the table.

26.9 Gene Set Test

The **Gene Set Test** tool tests whether GO terms are over-represented in a set of differentially expressed genes (input as a statistical comparison track) using a hypergeometric test. The tool will require a GO annotation file that must be previously saved in the Navigation Area of the workbench.

GO annotation files are available from several sources (Blast2Go, GO ontology database). Before import, check that the table does have a GO column, and if not, edit the table to change the relevant column header to GO before import in the workbench using the Standard Import function.

It is also possible to format a text file of custom annotations into a format the Gene Set Test tool can use (see section [K.5.2](#)).

- The file type should be .csv.
- The values should be comma-separated and in quotation marks.
- The first column should be "Probe Set ID" or one of the other recognized values mentioned in the manual, and the values in the first column must match the feature names in the data exactly.
- The actual annotations should be found in one of the "Gene Ontology"-type columns: Gene Ontology Biological Process, Gene Ontology Cellular Component, Gene Ontology Molecular Function.
- The separator // is used to separate the name of an annotation from its description, and the separator /// is used to separate different annotations from each other. Each annotation should then look like: "AnnotationA_name // AnnotationA description /// AnnotationB_name // AnnotationB description".

This custom annotation file can be imported using the Standard Import functionality.

To start the tool:

Toolbox | RNA-Seq Analysis | Gene Set Test

Select a statistical comparison track () and click **Next** (see figure [26.38](#)). To run several statistical comparisons at once, use the batch function.

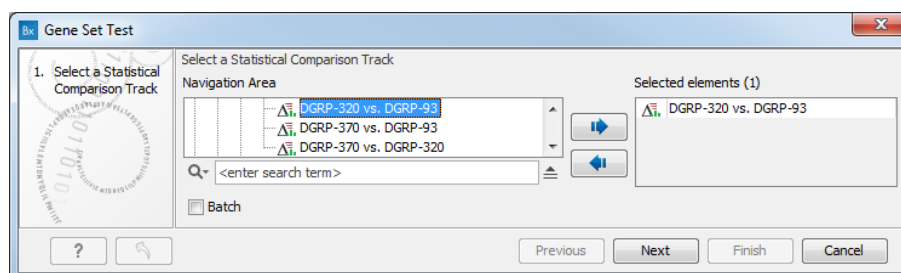

Figure 26.38: Select one statistical comparison.

In the "Annotation testing parameters" dialog, you need to specify a GO annotation file and have several annotation testing options(see figure [26.39](#)).

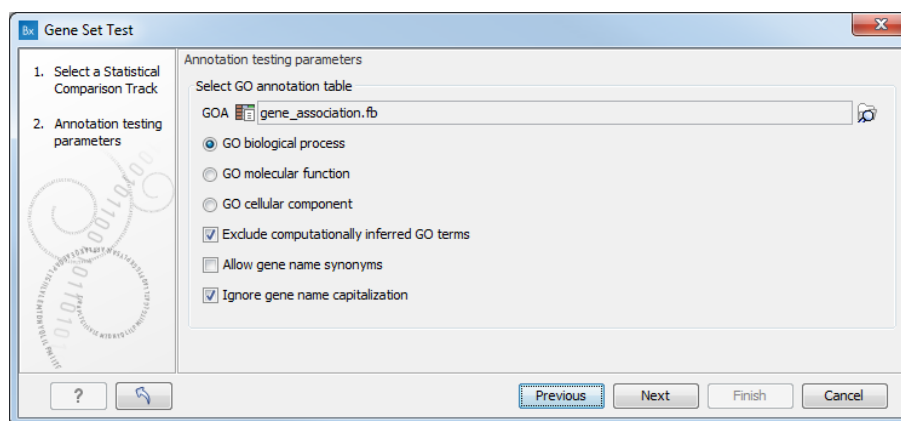

Figure 26.39: Select annotation testing parameters.

- **GOA:** Specify a GO annotation file (such as described in the introduction of this section) using the Browse button to the right of the field.
- **GO biological process** Tests for enriched GO biological processes, i.e., a series of events or molecular functions such as "lipid storage" or "chemical homeostasis".
- **GO molecular function** Tests for enriched GO molecular functions. The GO molecular functions of a gene can be such as "retinoic acid receptor activity" or "transcription regulator activity".
- **GO cellular component** Tests for enriched GO cellular component. A GO cellular component ontology describes locations, such as "nuclear inner membrane" or "ubiquitine ligase complex".
- **Exclude computationally inferred GO terms** excludes uncurated GO terms with evidence code IEA, i.e., terms that were automatically curated but not reviewed by a curator.
- **Allow gene name synonyms** allows matching of the gene name with database identifiers and synonyms.
- **Ignore gene name capitalization** ignores capitalization in feature names: a gene called "Dat" in the statistical comparison track will be matched with the one called "dat" in the annotation file when this option is checked. If "Dat" and "dat" are believed to be different genes, the option should be unchecked.

Click Next to access the "Filtering parameters" dialog (see figure 26.40).

Instead of annotating all genes present in the statistical comparison track, it is possible to focus on the subset of genes that are differentially expressed. The filtering parameters allow you to define this subset:

- **Ignore features with mean RPKM below.** Only features where the highest group mean RPKM exceeds this limit will be included in the analysis.
- **Minimum absolute fold change.** Define the minimum absolute fold change value for a feature, and specify whether this fold change should be calculated as **p-value**, **FDR p-value** or **Bonferroni** (for a detailed definition of these, see section 27.6.4).

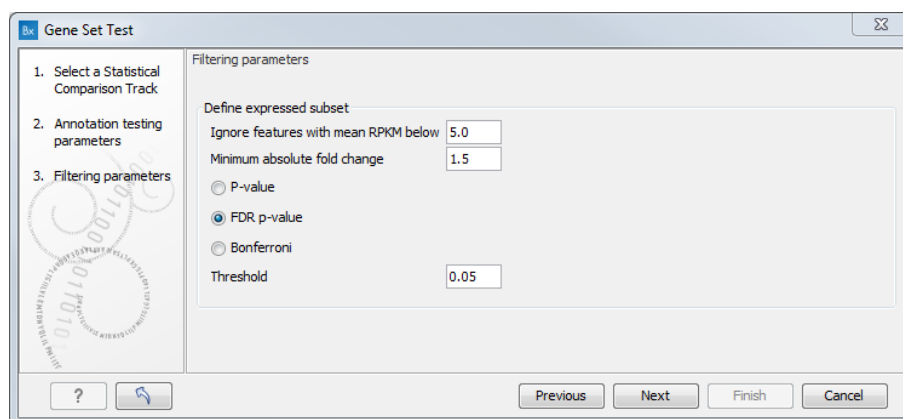

Figure 26.40: Specify filtering parameters.

- **Threshold.** Maximum p-value for a feature.

Click **Finish** to Open or Save the file in a specified location of the Navigation Area.

During analysis, a black banner in the left hand side of the workbench warns if duplicate features were found while processing the file. If you get this warning message, consider unchecking the "Ignore gene name capitalization" option.

The output is a table called "GO enrichment analysis" (see figure 26.41). The table is sorted in order of ascending p-values but it can easily be sorted differently, as well as filtered to highlight only the GO terms that are over-represented. The table also provides FDR and Bonferroni-corrected p-values. Note that the p-values provided in the table are meant as a guide, as GO annotations are not strictly independent of each other (for example, "reproduction" is a broad category that encompass a nested set of terms from other categories such as "pheromone biosynthetic process").

GO term	Description	Occurrence...	Occurrence...	P-values	FDR p-value	Bonferroni
0005996	monosaccharide metabolic process	6	2	4.59E-3	1.00	1.00
0006006	glucose metabolic process	6	2	4.59E-3	1.00	1.00
0017385	response to insecticide	6	2	4.59E-3	1.00	1.00
0019348	hexose metabolic process	6	2	4.59E-3	1.00	1.00
0006036	response to toxic substance	7	2	6.36E-3	1.00	1.00
0006621	protein retention in ER lumen	1	1	0.02	1.00	1.00
003437	maintenance of protein localization in endoplasmic reticulum	1	1	0.02	1.00	1.00
0046683	response to organophosphorus	1	1	0.02	1.00	1.00
0046689	response to mercury ion	1	1	0.02	1.00	1.00
0060248	cardiac muscle contraction	1	1	0.02	1.00	1.00
0072955	maintenance of protein localization in organelle	1	1	0.02	1.00	1.00
0050896	response to stimulus	296	10	0.03	1.00	1.00
0014070	response to organic cyclic compound	16	2	0.03	1.00	1.00
0000022	mitotic spindle elongation	2	1	0.04	1.00	1.00
0002022	regulation of heart rate	2	1	0.04	1.00	1.00
0002407	toxin catabolic process	2	1	0.04	1.00	1.00
0015893	drug transport	2	1	0.04	1.00	1.00
0042478	xenobiotic catabolic process	2	1	0.04	1.00	1.00

Figure 26.41: The GO enrichment analysis table generated by the Gene Set Test tool.

Chapter 27

Microarray and Small RNA Analysis

Contents

27.1 Small RNA analysis	807
27.1.1 Extract and count	807
27.1.2 Downloading miRBase	811
27.1.3 Annotating and merging small RNA samples	813
27.1.4 Working with the small RNA sample	822
27.1.5 Exploring novel miRNAs	824
27.2 Experimental design	825
27.2.1 Setting up an experiment	825
27.2.2 Organization of the experiment table	828
27.2.3 Adding annotations to an experiment	834
27.2.4 Scatter plot view of an experiment	835
27.2.5 Cross-view selections	837
27.3 Working with tracks and experiments	837
27.3.1 Data structures for transcriptomics	838
27.3.2 From Experiments to Tracks	839
27.3.3 Running the Create Track from Experiment tool	840
27.3.4 Interpreting the results of the Create Track from Experiment tool	843
27.3.5 Visualizing RNA-Seq read tracks for the experiment	845
27.4 Transformation and normalization	845
27.4.1 Selecting transformed and normalized values for analysis	846
27.4.2 Transformation	846
27.4.3 Normalization	847
27.5 Quality control	849
27.5.1 Creating box plots - analyzing distributions	850
27.5.2 Hierarchical clustering of samples	854
27.5.3 Principal component analysis	858
27.6 Statistical analysis - identifying differential expression	863
27.6.1 Empirical analysis of DGE	863
27.6.2 Tests on proportions	867
27.6.3 Gaussian-based tests	869

27.6.4	Corrected p-values	871
27.6.5	Volcano plots - inspecting the result of the statistical analysis	872
27.7	Feature clustering	874
27.7.1	Hierarchical clustering of features	875
27.7.2	K-means/medoids clustering	879
27.8	Annotation tests	882
27.8.1	Hypergeometric tests on annotations	882
27.8.2	Gene set enrichment analysis	885
27.9	General plots	888
27.9.1	Histogram	888
27.9.2	MA plot	891
27.9.3	Scatter plot	894

27.1 Small RNA analysis

The small RNA analysis tools in *CLC Genomics Workbench* are designed to facilitate trimming of sequencing reads, counting and annotating of the resulting tags using miRBase or other annotation sources and performing expression analysis of the results. The tools are general and flexible enough to accommodate a variety of data sets and applications within small RNA profiling, including the counting and annotation of both microRNAs and other non-coding RNAs from any organism. Illumina, 454 and SOLiD sequencing platforms are supported. For SOLiD, adapter trimming and annotation is done in color space.

The annotation part is designed to make special use of the information in miRBase but more general references can be used as well.

There are generally two approaches to the analysis of microRNAs or other smallRNAs: (1) count the different types of small RNAs in the data and compare them to databases of microRNAs or other smallRNAs, or (2) map the small RNAs to an annotated reference genome and count the numbers of reads mapped to regions which have smallRNAs annotated. The approach taken by *CLC Genomics Workbench* is (1). This approach has the advantage that it does not require an annotated genome for mapping – you can use the sequences in miRBase or any other sequence list of smallRNAs of interest to annotate the small RNAs. In addition, small RNAs that would not have mapped to the genome (e.g. when lacking a high-quality reference genome or if the RNAs have not been transcribed from the host genome) can still be measured and their expression be compared. The methods and tools developed for *CLC Genomics Workbench* are inspired by the findings and methods described in [Creighton et al., 2009], [Wyman et al., 2009], [Morin et al., 2008] and [Stark et al., 2010].

In the following, the tools for working with small RNAs are described in detail.

27.1.1 Extract and count

First step in the analysis is to import the data (see section 6.3).

The next step is to extract and count the small RNAs to create a *small RNA sample* that can be used for further analysis (either annotating or analyzing using the expression analysis tools):

Toolbox | Microarray and Small RNA Analysis (📁) | Small RNA Analysis (📁) | Extract and Count (🔑)

This will open a dialog where you select the sequencing reads that you have imported. Click **Next** when the sequencing data is listed in the right-hand side of the dialog. Note that if you have several samples, they should be processed separately.

This dialog (see figure 27.1) is where you specify whether the reads should be trimmed for adapter sequences prior to counting. It is often necessary to trim off remainders of adapter sequences from the reads before counting.

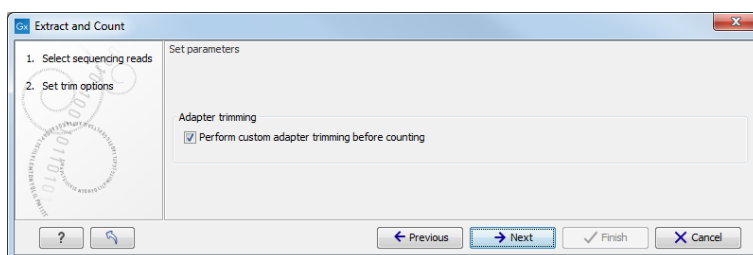

Figure 27.1: Specifying whether adapter trimming is needed.

When you click **Next**, you will be able to specify how the trim should be performed as shown in figure 27.2.

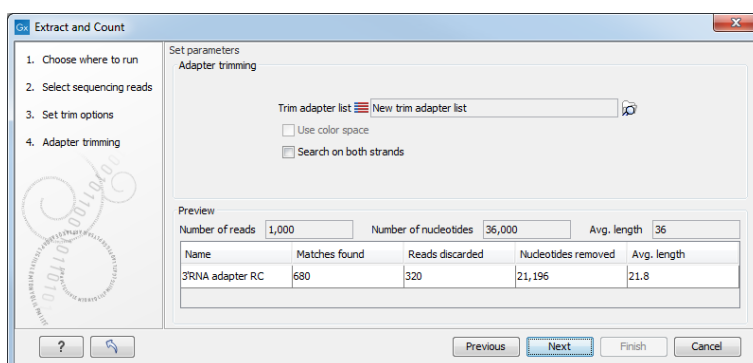

Figure 27.2: Setting parameters for adapter trim.

If you have chosen not to trim the reads for adapter sequence, you will see figure 27.3 instead.

The trim options shown in figure 27.2 are the same as described under adapter trim in section 22.1.2. Please refer to this section for more information.

It should be noted that if you expect to see part of adapters in your reads, you would typically choose **Discard when not found** as the action. By doing this, only reads containing the adapter sequence will be counted as small RNAs in the further analysis. If you have a data set where the adapter may be there or not you would choose **Remove adapter**.

Note that all reads will be trimmed for ambiguity symbols such as N before the adapter trim.

Clicking **Next** allows you to specify additional options regarding trimming and counting as shown in figure 27.3.

At the top you can choose to **Trim bases** by specifying a number of bases to be removed from either the 3' or the 5' end of the reads. Below, you can specify the minimum and maximum lengths of the small RNAs to be counted (this is the length after trimming). The minimum length

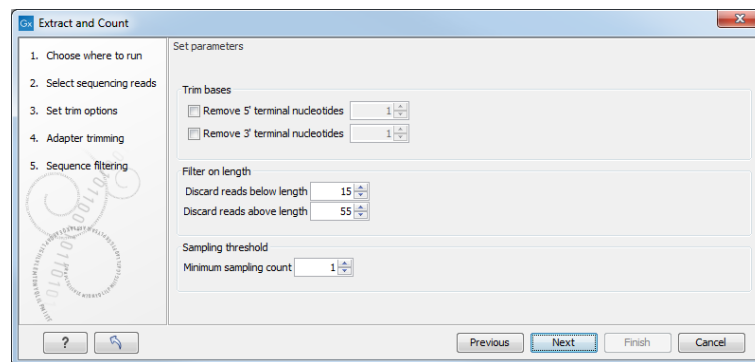

Figure 27.3: Defining length interval and sampling threshold.

that can be set is 15 and the maximum is 55.

At the bottom, you can specify the **Minimum sampling count**. This is the number of copies of the small RNAs (tags) that are needed in order to include it in the resulting count table (the small RNA sample). The actual counting is very simple and relies on **perfect match** between the reads to be counted together¹. This also means that a count threshold of 1 will include a lot of unique tags as a result of sequencing errors. In order to set the threshold right, the following should be considered:

- If the sample is going to be *annotated*, annotations may be found for the tags resulting from sequencing errors. This means that there is no negative effect of including tags with a low count in the output.
- When using *un-annotated sequences* for discovery of novel small RNAs, it may be useful to apply a higher threshold to eliminate the noise from sequencing errors. However, this can be done at a later stage by filtering the sample and creating a sub-set.
- When multiple samples are compared, it is interesting to know if one tag which is abundant in one sample is also found in another, even at a very low number. In this case, it is useful to include the tags with very low counts, since they may become more trustworthy in combination with information from other samples.
- Setting the count threshold higher will reduce the size of the sample produced which will reduce the memory and disk usage when working with the results.

Clicking **Next** allows you to specify the output of the analysis as shown in 27.4.

The options are:

Create sample This is the primary result showing all the tags and respective counts (an example is shown in figure 27.5). Each row represents a tag with the actual sequence as the feature ID and columns with **Expression values**, **Length**, and **Count**. Expression values and the actual count are based on 100 % similarity². The sample can be used in further analysis in the "raw" form, or you can annotate it (see below). The tools for working with the data in the sample are described in section 27.1.4. Note that when small RNA samples are used for setting up and experiment, it is always the Expression values that will be used.

¹Note that you can identify variants of the same miRNA when annotating the sample (see below).

²Note that you can identify variants of the same miRNA when annotating the sample (see below).

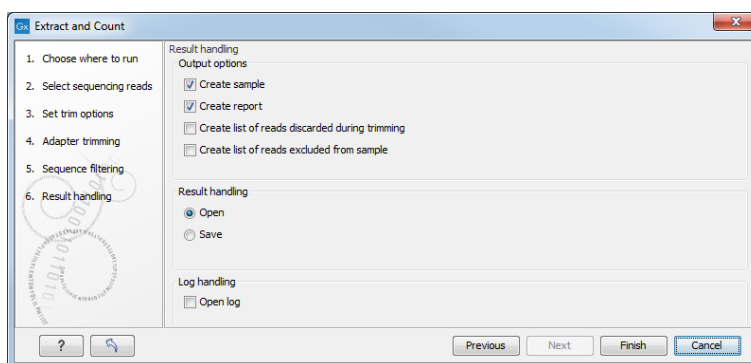

Figure 27.4: Output options.

Create report This will create a summary report as described below.

Create list of reads discarded during trimming This list contains the reads where no adapter was found (when choosing **Discard when not found** as the action).

Create list of reads excluded from sample This list contains the reads that passed the trimming but failed to meet the sampling thresholds regarding minimum/maximum length and number of copies.

Small RNA	Expression values	Length	Count
CCCCGGCTCGGCACCC	1.00	17	1
AGGCACATTGTCTCTGGTTTC	1.00	22	1
TAAAAATTCGGTTGGTA	1.00	18	1
TATCACCATCTGAAATCGTTTA	1.00	22	1
AGCAGCAGTGGACAGGGCGCGA	1.00	23	1
CTACAGTCCCACGACC	1.00	16	1
TACCACAGGTTGAACCACTGACA	1.00	24	1
ACAGCAAGACGAGAAGACCC	1.00	20	1
AGGGGTATGAGTCTCGGT	1.00	18	1
ATAGTTAGTACGTTTCAT	1.00	18	1
ACCTGGCATACAATGGAGATTTCTGT	1.00	26	1
CAACGGAAACCCAAAAGCACTGT	1.00	24	1
ATAGCTAAGTCCAAA	1.00	16	1
CCATAAAGGGAGGAGTAGA	1.00	19	1
CGGAGAGAAAGGCAGTTCCTTA	1.00	22	1
TCACTGGGAATTCAGCCTCTGAA	1.00	23	1
AAGCCCTTACCCAAAAGAAT	1.00	22	1
ACTGGACTTGGAGCACAAATGC	1.00	22	1

Figure 27.5: The tags have been extracted and counted.

The summary report includes the following information (an example is shown in figure 27.6):

Trim summary Shows the following information for each input file:

- Number of reads in the input.
- Average length of the reads in the input.
- Number of reads after trim. The difference between the number of reads in the input and this number will be the number of reads that are discarded by the trim.
- Percentage of the reads that pass the trim.
- Average length after trim. When analyzing miRNAs, you would expect this number to be around 22. If the number is significantly lower or higher, it could indicate that the trim settings are not right. In this case, check that the trim sequence is correct, that the strand is right, and adjust the alignment scores. Sometimes it is preferable to

increase the minimum scores to get rid of low-quality reads. The average length after trim could also be somewhat larger than 22 if your sequenced data contains a mixture of miRNA and other (longer) small RNAs.

Read length before/after trimming Shows the distribution of read lengths before and after trim. The graph shown in figure 27.6 is typical for miRNA sequencing where the read lengths after trim peaks at 22 bp.

Trim settings The trim settings summarized. Note that ambiguity characters will automatically be trimmed.

Detailed trim results This is described under adapter trim in section 22.1.2.

Tag counts The number of tags and two plots showing on the x-axis the counts of tags and on the y-axis the number of tags for which this particular count is observed. The plot is in a zoomed version where only the lower part of the y-axis is shown to make it possible to see the numbers of tags higher counts.

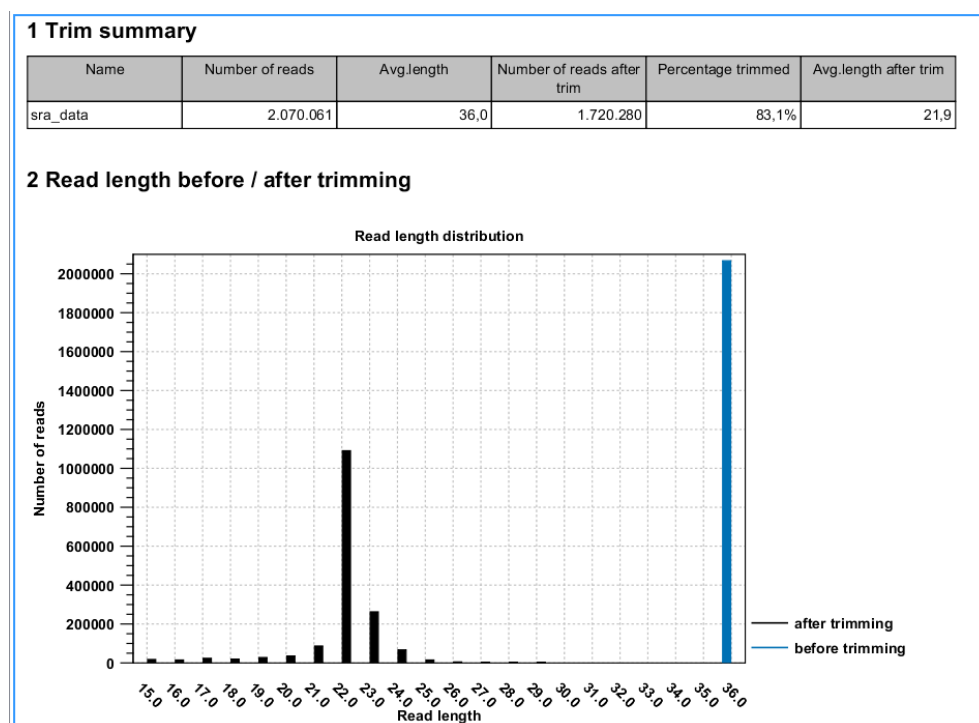

Figure 27.6: A summary report of the counting.

27.1.2 Downloading miRBase

In order to make use of the additional information about mature regions on the precursor miRNAs in miRBase, you need to use the integrated tool to download miRBase rather than downloading it from <http://www.mirbase.org/>:

Toolbox | Microarray and Small RNA | Small RNA Analysis () | Download miRBase ()

This will download a sequence list with all the precursor miRNAs including annotations for mature regions. The list can then be selected when annotating the samples with miRBase (see section 27.1.3).

The downloaded version will always be the latest version (it is downloaded from <ftp://mirbase.org/pub/mirbase/CURRENT/miRNA.dat.gz>). Information on the version number of miRBase is also available in the **History** (📄) of the downloaded sequence list, and when using this for annotation, the annotated samples will also include this information in their **History** (📄).

Importing the miRBase data file You can also import the miRBase data file directly into the Workbench. The file can be downloaded from <ftp://mirbase.org/pub/mirbase/CURRENT/miRNA.dat.gz>.

In order for the file to be recognized as a miRBase file, you have to select `miRBase dat` in the **Force import as type** menu of the Standard Import dialog.

A *.dat file follows the following format:

```
ID cel-let-7
XX
DE Caenorhabditis elegans let-7 stem-loop
XX
FH Key Location/Qualifiers
FH
FT miRNA 17..38
FT /product="cel-let-7-5p"
FT miRNA 60..81
FT /product="cel-let-7-3p"
XX
SQ Sequence 99 BP; 26 A; 19 C; 24 G; 0 T; 30 other;
uacacugugg auccggugag guaguagguu guauaguuug gaauauuacc accggugaac 60
uaugcauuuu ucuaccuuac cggagacaga acucuucga 99
//
ID cel-lin-4
XX
DE Caenorhabditis elegans lin-4 stem-loop
XX
FH Key Location/Qualifiers
FH
FT miRNA 16..36
FT /product="cel-lin-4-5p"
FT miRNA 55..76
FT /product="cel-lin-4-3p"
XX
SQ Sequence 94 BP; 17 A; 25 C; 26 G; 0 T; 26 other;
augcuuccgg ccuguucccu gagaccucaa gugugagugu acuauugaug cuucacacu 60
gggcucuccg gguaccagga cgguuugagc agau 94
//
```

Creating your own miRBase file If you wish to construct a file yourself to be used as a miRBase file for annotation, this is also possible if you format the file in the same way as the miRBase

data file. In particular, the following needs to be in place:

- The sequences needs "miRNA" annotation on the precursor sequences. In the Workbench, you can add a miRNA annotation by selecting a region and right click to **Add Annotation**. You should have a max 2 miRNA annotations per precursor sequences. Matches to first miRNA annotation are counting in 5' column. Matches to second miRNA annotation are counted as 3' matches.
- If you have sequence list containing sequences from multiple species, the **Latin name** of the sequences should be set. This is used in the annotation dialog (see section 27.1.3) where you can select the species. If the Latin name is not set, the dialog will show "N/A".

Once you have created the file, it has to be imported as described above.

27.1.3 Annotating and merging small RNA samples

The small RNA sample produced when counting the tags (see section 27.1.1) can be enriched by *CLC Genomics Workbench* by comparing the tag sequences with annotation resources such as miRBase and other small RNA annotation sources. Note that the annotation can also be performed on an experiment, set up from small RNA samples (see section 27.2.1).

Besides adding annotations to known small RNAs in the sample, it is also possible to merge variants of the same small RNA to get a cumulative count. When initially counting the tags, the Workbench requires that the trimmed reads are identical for them to be counted as the same tag. However, you will often see different variants of the same miRNA in a sample, and it is useful to be able to count these together. This is also possible using the tool to annotate and merge samples.

Toolbox | Microarray and Small RNA Analysis | Small RNA Analysis (🔑) | Annotate and Merge Counts (📄)

This will open a dialog where you select the small RNA samples (🔑) to be annotated. Note that if you have included several samples, they will be processed separately but summarized in one report providing a good overview of all samples. You can also input **Experiments** (📄) (see section 27.2.1) created from small RNA samples. Click **Next** when the data is listed in the right-hand side of the dialog.

This dialog (figure 27.7) is where you define the annotation resources to be used.

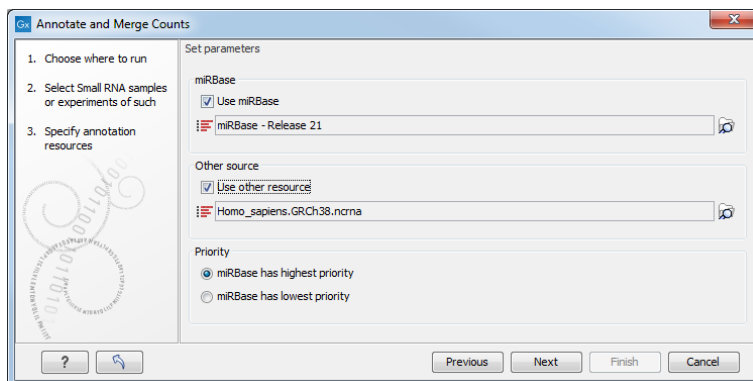

Figure 27.7: Defining annotation resources.

There are two ways of providing annotation sources:

- Downloading miRBase using the integrated download tool (explained in section 27.1.2).
- Importing a list of sequences, e.g. from a fasta file. This could be from Ensembl, e.g. ftp://ftp.ensembl.org/pub/release-57/fasta/homo_sapiens/ncrna/Homo_sapiens.GRCh37.57.ncrna.fa.gz or from ncrna.org: <http://www.ncrna.org/frnadb>.

Note: We recommend using the integrated download tool to import miRBase. Although it is possible to import it as a fasta file, the same options with regards to species will not be available if you import from a file.

The downloaded miRBase file contains all precursor sequences from the latest version of miRBase <http://www.mirbase.org/> including annotations defining the mature regions (see an example in figure 27.8).

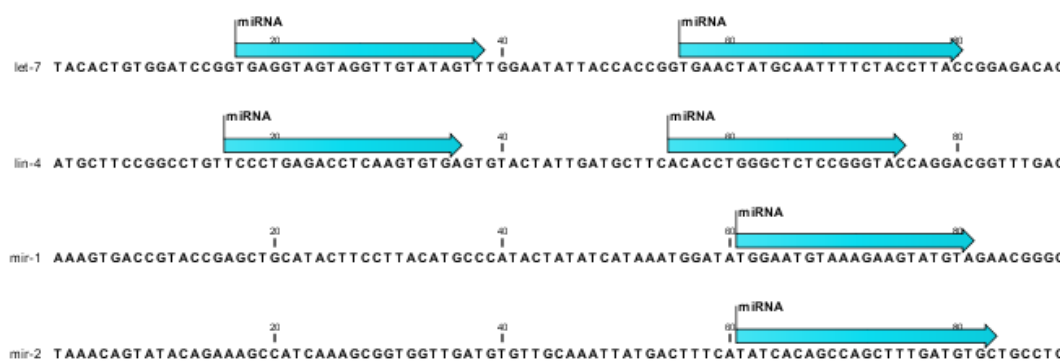

Figure 27.8: Some of the precursor miRNAs from miRBase have both 3' and 5' mature regions (previously referred to as mature and mature*) annotated (as the two first in this list).

This means that it is possible to have a more fine-grained classification of the tags using miRBase compared to a simple fasta file resource containing the full precursor sequence. This is the reason why the miRBase annotation source is specified separately in figure 27.7.

At the bottom of the dialog, you can specify whether miRBase should be prioritized over the additional annotation resource. The prioritization is explained in detail later in this section. To prioritize one over the other can be useful when there is redundant information (e.g. if you have an additional source that also contains all the miRNAs from miRBase and you prefer the miRBase annotations when possible).

When you click **Next**, you will be able to choose which species from miRBase should be used and in which order (see figure 27.9). Note that if you have not selected a miRBase annotation source, you will go directly to the next step shown in figure 27.10.

To the left, you see the list of species in miRBase. This list is dynamically created based on the information in the miRBase file. Using the arrow button (➡) you can add species to the right-hand panel. The order of the species is important since the tags are annotated iteratively based on the order specified here. This means that in the example in figure 27.9, a human miRNA will be preferred over mouse, even if they are identical in sequence (the prioritization is elaborated below). The up and down arrows (⬆)/ (⬇) can be used to change the order of species.

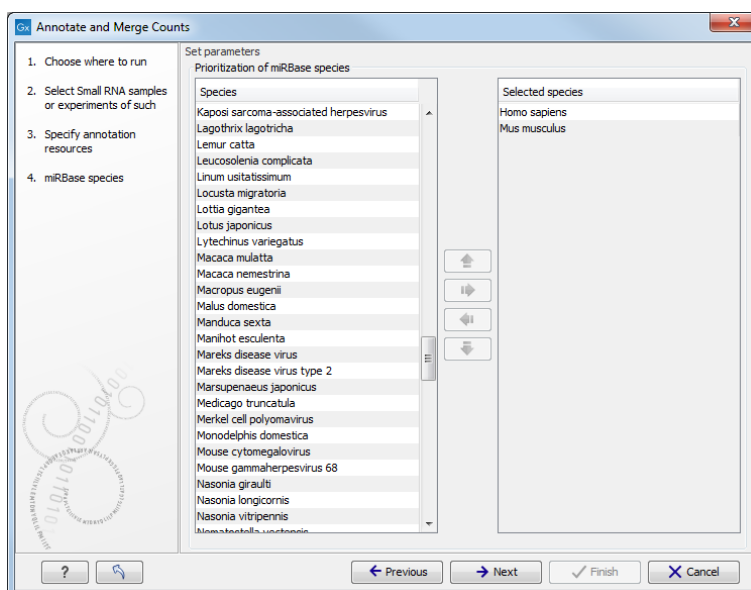

Figure 27.9: Defining and prioritizing species in miRBase.

When you click **Next**, you will be able to specify how the alignment of the tags against the annotation sources should be performed (see figure 27.10).

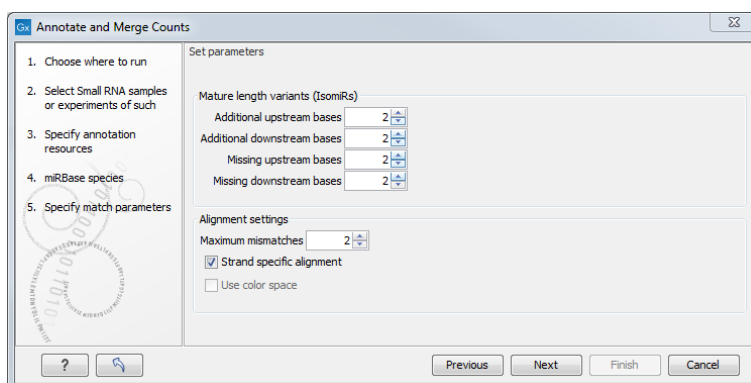

Figure 27.10: Setting parameters for aligning.

The panel at the top is active only if you have chosen to annotate with miRBase. It is used to define the requirements to the alignment of a read for it to be counted as a 3' or 5' mature region (previously referred to as mature and mature*) tag:

Additional upstream bases This defines how many bases the tag is allowed to extend the annotated mature region at the 5' end and still be categorized as mature.

Additional downstream bases This defines how many bases the tag is allowed to extend the annotated mature region at the 3' end and still be categorized as mature.

Missing upstream bases This defines how many bases the tag is allowed to miss at the 5' end compared to the annotated mature region and still be categorized as mature.

Missing downstream bases This defines how many bases the tag is allowed to miss at the 3' end compared to the annotated mature region and still be categorized as mature.

At the bottom of the dialog you can specify the **Maximum mismatches** (default value is 2). Furthermore, you can specify if the alignment and annotation should be performed in **color space** which is available when your small RNA sample is based on SOLiD data.³ Finally, you can choose whether the tags should be aligned against both strands of the reference or only the positive strand. Usually it is only necessary to align against the positive strand.

At this point, a more elaborate explanation of the annotation algorithm is needed. The short read mapping algorithm in the *CLC Genomics Workbench* is used to map all the tags to the reference sequences which comprise the full precursor sequences from miRBase and the sequence lists chosen as additional resources. The mapping is done in several rounds: the first round is done requiring a perfect match, the second allowing one mismatch, the third allowing two mismatches etc. No gaps are allowed. The number of rounds depend on the number of mismatches allowed⁴ (default is two which means three rounds of read mapping, see figure 27.10).

After each round of mapping, the tags that are mapped will be removed from the list of tags that continue to the next round. This means that a tag mapping with perfect match in the first round will not be considered for the subsequent one-mismatch round of mapping.

Following the mapping, the tags are classified into the following categories according to where they match.

- Mature 5' exact
- Mature 5' super
- Mature 5' sub
- Mature 5' sub/super
- Mature 3' exact
- Mature 3' super
- Mature 3' sub
- Mature 3' sub/super
- Precursor
- Other

All these categories except *Other* refer to hits in miRBase. For hits on miRBase sequences we distinguish between where on the sequences the tags match. The miRBase sequences may have up to two mature micro RNAs annotated. We refer to a mature miRNA that is located closer (or equally close) to the 5' end than to the 3' end as 'Mature 5''. A mature miRNA that is located closer to the 3' end is referred to as 'Mature 3''. *Exact* means that the tag matches exactly to the annotated mature 5' or 3' region; *Sub* means that the observed tag is shorter than the annotated mature 5' or mature 3'; *super* means that the observed tag is longer than the annotated mature 5' or mature 3'. The combination *sub/super* means that the observed tag extends the annotation

³Note that this option is only going to make a difference for tags with low counts. Since the actual tag counting in the first place is done based on perfect matches, the highly abundant tags are not likely to have sequencing errors, and aligning in color space does not add extra benefit for these.

⁴For color space, the maximum number of mismatches is 2.

in one end and is shorter at the other end. Precursor means that the tag matches on a mirBase sequence, but not within the extended annotated mature region(s). These are defined by the "mature length variants (IsomiRs)" parameters in the "specify match parameters" wizard step (by default these parameters are set to 2 which means that reads that are at most 2 bases too long or too short relative to the annotated mature region are all considered mature hits). The Other category is for hits in the other resources (the information about resource is also shown in the output).

An example of an alignment is shown in figure 27.11 using the same alignment settings as in figure 27.10.

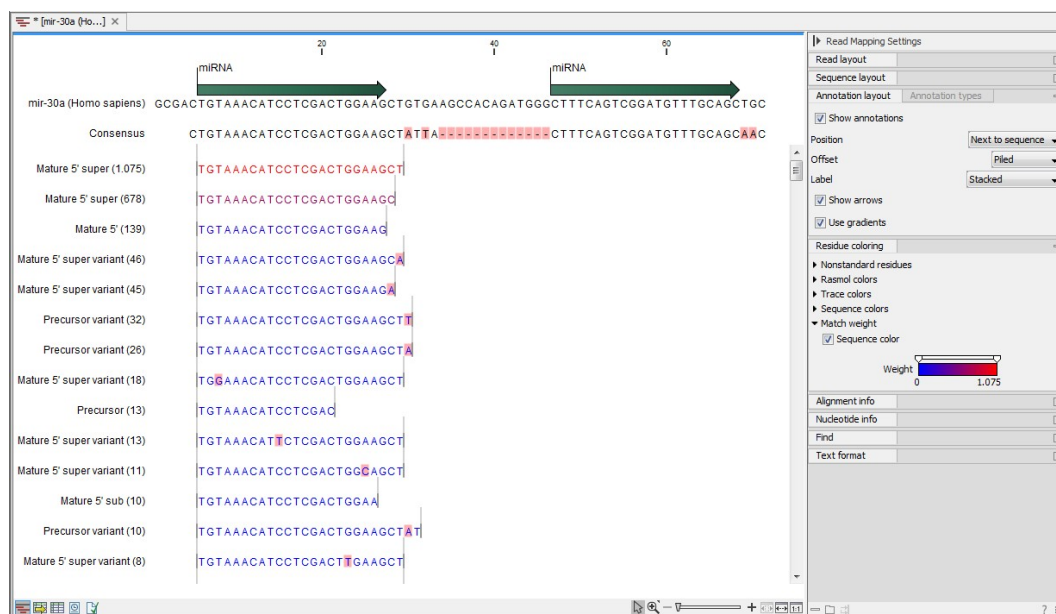

Figure 27.11: Alignment of length variants of mir-30a.

The two tags at the top are both classified as *mature 5' super* because they cover and extend beyond the annotated mature 5' RNA. The third tag is identical to the annotated mature 5'.

If a tag has several hits, the list above is used for prioritization. This means that e.g. a *Mature 5' sub* is preferred over a *Mature 3' exact*. Note that if miRBase was chosen as lowest priority (figure 27.7), the *Other* category will be at the top of the list. All tags mapping to a miRBase reference without qualifying to any of the mature 5' and mature 3' types will be typed as *Other*. Also note that if a tag has several hits to references with the same priority (e.g. the tag matches the mature regions of two different miRBase sequences) it will be annotated with all these sequences. In the report we refer to these tags as 'ambiguously annotated'.

In case you have selected more than one species for miRBase annotation (e.g. Homo Sapiens and Mus Musculus) the following rules for adding annotations apply:

1. If a tag has hits with the same priority for both species, the annotation for the top-prioritized species will be added.
2. Read category priority is stronger than species category priority: If a read is a higher priority match for a mouse miRBase sequence than it is for a human miRBase sequence the annotation for the mouse will be used

Clicking **Next** allows you to specify the output of the analysis as shown in 27.12.

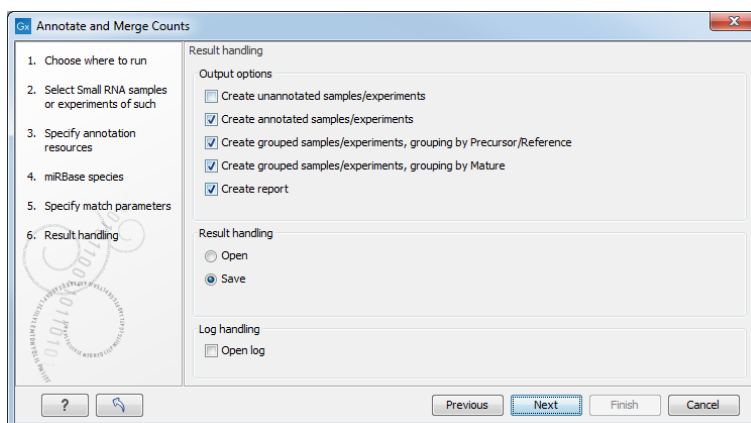

Figure 27.12: Output options.

The options are:

Create unannotated sample All the tags where no hit was found in the annotation source are included in the unannotated sample. This sample can be used for investigating novel miRNAs, see section 27.1.5. No extra information is added, so this is just a subset of the input sample.

Create annotated sample This will create a sample as described in section 27.1.4. In this sample, the following columns have been added to the counts.

Name This is the name of the annotation sequence in the annotation source. For miRBase, it will be the names of the miRNAs (e.g. *let-7g* or *mir-147*), and for other source, it will be the name of the sequence.

Resource This is the source of the annotation, either miRBase (in which case the species name will be shown) or other sources (e.g. *Homo_sapiens.GRCh37.57.ncrna*).

Match type The match type can be exact or variant (with mismatches) of the following types:

- Mature 5'
- Mature 5' super
- Mature 5' sub
- Mature 5' sub/super
- Mature 3'
- Mature 3' super
- Mature 3' sub
- Mature 3' sub/super
- Other

Mismatches The number of mismatches.

Note that if a tag has two equally prioritized hits, they will be shown with // between the names. This could be e.g. two precursor sequences sharing the same mature sequence (also see the sample grouped on mature below).

Create grouped sample, grouping by Precursor/Reference This will create a sample as described in section 27.1.4. All variants of the same reference sequence will be merged to create one expression value for all.

Expression values. The expression value can be changed at the bottom of the table. The default is to use the counts in the mature 5' column.

Name. The name of the reference. For miRBase this will then be the name of the precursor.

Resource. The name of the resource that the reference comes from.

Exact mature 5'. The number of exact mature 5' reads.

Mature 5'. The number of all mature 5' reads including sub, super and variants.

Unique exact mature 5'. In cases where one tag has several hits (as denoted by the // in the ungrouped annotated sample as described above), the counts are distributed evenly across the references. The difference between *Exact mature 5'* and *Unique exact mature 5'* is that the latter only includes reads that are unique to this reference.

Unique mature 5'. Same as above but for all mature 5's, including sub, super and variants.

Exact mature 3'. Same as above, but for mature 3'.

Mature 3'. Same as above, but for mature 3'.

Unique exact mature 3'. Same as above, but for mature 3'.

Unique mature 3'. Same as above, but for mature 3'.

Exact other. Exact matches in miRBase sequences, but outside annotated mature regions.

Other. All matches in miRBase sequences, but outside annotated mature regions, including variants.

Total. The total number of tags mapped and classified to the precursor/reference sequence.

Note that, for non-miRBase sequences, the counts are collected in the 'Mature 5'' columns: 'Exact mature 5'' (number reads that map to the sequence without mismatches), 'Mature 5'' (number reads that map to the sequence, including those with mismatches), 'Unique exact mature 5'' (number reads that map uniquely to the sequence without mismatches) and 'Unique mature 5'' (number reads that map uniquely to the sequence, including those with mismatches).

Create grouped sample, grouping by Mature This will create a sample as described in section 27.1.4. This is also a grouped sample, but in addition to grouping based on the same reference sequence, the tags in this sample are grouped on the same mature 5'. This means that two precursor variants of the same mature 5' miRNA are merged. For precursor miRNAs that have both a 5' and a 3', we group on both 5' mature and 3' mature. For these miRNAs you will see two rows in the grouped on mature output table, one with the 5' mature sequence as feature ID and one with the 3' mature sequence as feature ID. The 'Match type' column indicates whether the feature ID is 5' or 3' mature. Note that it is only possible to create this sample when using miRBase as annotation resource (because the Workbench has a special interpretation of the miRBase annotations for mature as described previously). To find identical mature 5' miRNAs, the Workbench compares all the mature 5' sequences and when they are identical, they are merged. The names of the precursor sequences merged are all shown in the table.

Expression values. The expression value can be changed at the bottom of the table. The default is to use the counts in the mature 5' column.

Name. The name of the reference. When several precursor sequences have been merged, all the names will be shown separated by //.

Resource. The species of the reference.

Exact mature 5'. The number of exact mature 5' reads.

Mature 5'. The number of all mature 5' reads including sub, super and variants.

Unique exact mature 5'. In cases where one tag has several hits (as denoted by the // in the ungrouped annotated sample as described above), the counts are distributed evenly across the references. The difference between *Exact mature 5'* and *Unique exact mature 5'* is that the latter only includes reads that are unique to one of the precursor sequences that are represented under this mature 5' sequence.

Unique mature 5'. Same as above but for all mature 5's, including sub, super and variants.

Create report. A summary report described below.

The summary report includes the following information (an example is shown in figure 27.13):

Summary Shows the following information for each input sample:

- Number of small RNAs(tags) in the input.
- Number of annotated tags (number and percentage).
- Number of ambiguously annotated tags (number and percentage).
- Number of reads in the sample (one tag can represent several reads)
- Number of annotated reads (number and percentage).
- Number of ambiguously annotated reads (number and percentage).

Resources Shows how many matches were found in each resource:

- Number of sequences in the resource.
- Number of sequences where a match was found (i.e. this sequence has been observed at least once in the sequencing data).

Reads Shows the number of reads that fall into different categories (there is one table per input sample). On the left hand side are the annotation resources. For each resource, the count and percentage of reads in that category are shown. Note that the percentage are relative to the overall categories (e.g. the miRBase reads are a percentage of all the *annotated* reads, not all reads). This information is shown for each mismatch level.

Small RNAs Similar numbers as for the reads but this time for each small RNA tag and without mismatch differentiation.

Read count proportions A histogram showing, for each interval of read counts, the proportion of annotated (respectively, unannotated) small RNAs with a read count in that interval. Annotated small RNAs may be expected to be associated with higher counts, since the most abundant small RNAs are likely to be known already.

1 Summary

Name	Small RNAs	Annotated	Percentage	Ambiguously annotated	Percentage	Reads	Annotated	Percentage	Ambiguously annotated	Percentage
sra_data Small RNA sample	88.470	32.125	36,3%	9.788	11,1%	1.720.280	1.510.721	87,8%	971.902	56,5%

2 Resources

Resource	Sequences in resource	Sequences found	Percentage found
miRBase (Homo sapiens)	1.600	599	37,4%
miRBase (Mus musculus)	855	84	9,8%
Homo_sapiens.GRCh37.57.ncrna	12.887	3.655	28,4%

3 Reads

Annotation	Count	Percentage	Perfect matches	%	1 mismatch	%	2 mismatches	%
Annotated	1.510.721	87,8%	1.212.258	80,2%	247.484	16,4%	50.979	3,4%
- with miRBase	1.467.902	97,2%	1.188.128	80,9%	234.583	16,0%	45.191	3,1%
- Homo sapiens	1.456.045	99,2%	1.182.700	81,2%	230.445	15,8%	42.900	2,9%
- Mus musculus	11.857	0,8%	5.428	45,8%	4.138	34,9%	2.291	19,3%
- with Homo_sapiens.GRCh37.57.ncrna	42.819	2,8%	24.130	56,4%	12.901	30,1%	5.788	13,5%
Unannotated	209.559	12,2%						
Total	1.720.280	100,0%						

4 Small RNAs

Annotation	Count	Percentage
Annotated	32.125	36,3%
- with miRBase	21.490	66,9%
- Homo sapiens	20.259	94,3%
- Mus musculus	1.231	5,7%
- with Homo_sapiens.GRCh37.57.ncrna	10.635	33,1%
Unannotated	56.345	63,7%
Total	88.470	100,0%

Figure 27.13: A summary report of the annotation.

Annotations (miRBase) Shows an overview table for classifications of the number of reads that fall in the miRBase categories for each species selected.

Annotations (Other) Shows an overview table with read numbers for total, exact match and mutant variants for each of the other annotation resources.

An example of the results table is shown at the bottom of figure 27.14.

In the upper part of the figure, you can see two tables showing the imported miRBase file (opened twice for illustration purpose). This example has been included to illustrate the logic behind the order in which the resources are listed. If you look at the results table found at the bottom of the figure, you will see that in the **Resource** column, Mus musculus is listed before Homo sapiens in the first row and in the second row Homo sapiens is listed before Mus musculus. The rationale behind this can be seen from the two other tables if you look at the accession numbers. If you filter only to include Homo sapiens and Mus musculus RNAs, and sort on the "name" column, you can see that for mir-130b (Mus musculus/Homo sapiens), the miRBase number of the mouse RNA is smaller than the miRBase number of the human RNA. Conversely, for mir-495 (Homo sapiens/Mus musculus), the number is smaller in the human case.

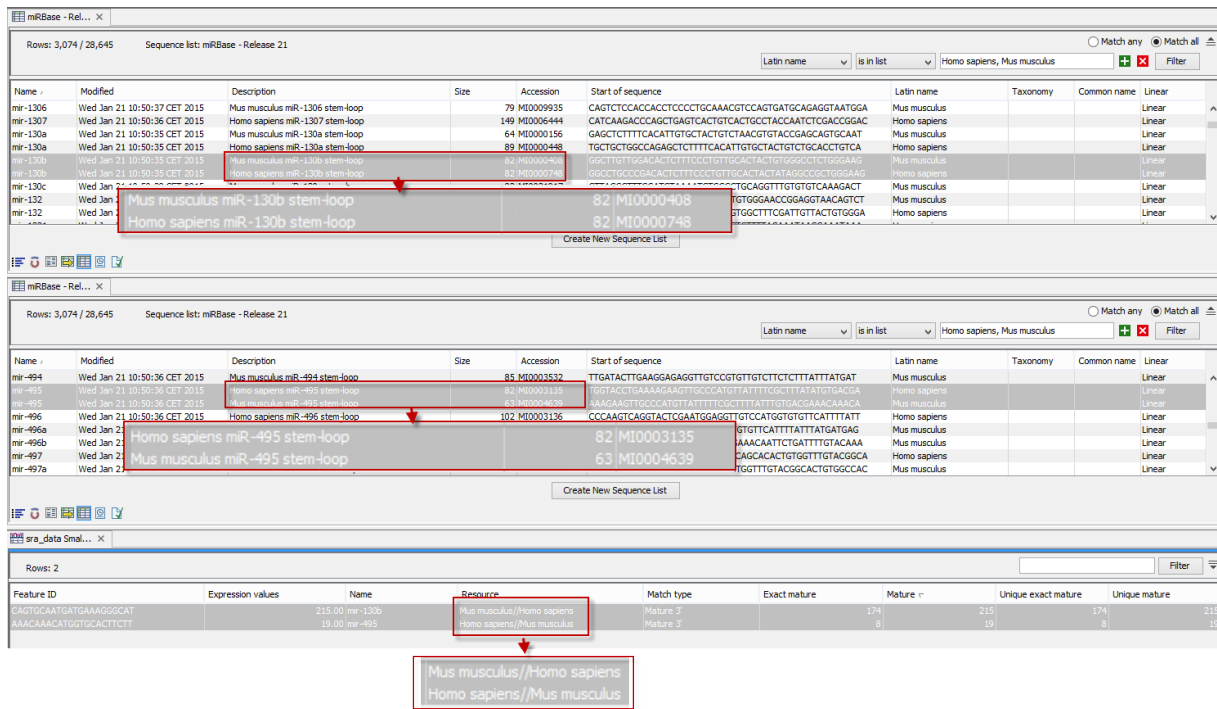

Figure 27.14: The results table (at the bottom of the figure) shown in split view with the imported miRBase data shown twice to illustrate that the order in which the resource is listed is determined by the miRBase accession number. Due to the very small fonts in the table, the most important information has been magnified (red box).

27.1.4 Working with the small RNA sample

Generally speaking, the small RNA sample comes in two variants:

- The *un-grouped* sample, either as it comes directly from the **Extract and Count** (🔑) or when it has been annotated. In this sample, there is one row per tag, and the feature ID is the tag sequence.
- The *grouped* sample created using the **Annotate and Merge Counts** (📊) tool. In this sample, each row represents several tags grouped by a common Mature or Precursor miRNA or other reference.

Below, these two kinds of samples are described in further detail. Note that for both samples, filtering and sorting can be applied, see section 3.3.

The un-grouped sample

An example of an un-grouped annotated sample is shown in figure 27.15.

By selecting one or more rows in the table, the buttons at the bottom of the view can be used to extract sequences from the table:

Extract Reads (📄) This will extract the original sequencing reads that contributed to this tag. Figure 27.16 shows an example of such a read. The reads include trim annotations (for use when inspecting and double-checking the results of trimming). Note that if these reads

Small RNA	Length	Count	Name	Resource	Match type	Mismatches
TGAGGTAGTAGATT...	22	508243	let-7f-1//let-7f-2	Homo sapiens	Mature	0
TGAGGTAGTAGATT...	22	214980	let-7a-1//let-7a-2//let-7a-3	Homo sapiens	Mature	0
TGAGGTAGGAGGTT...	22	31555	let-7e	Homo sapiens	Mature	0
TAGCACCATCTGAA...	22	30689	mir-29a	Homo sapiens	Mature	0
TGAGGTAGTAGTTT...	22	26600	let-7i	Homo sapiens	Mature	0
TGAGGTAGTAGTTT...	22	24055	let-7b	Homo sapiens	Mature	0
AGAGGTAGTAGTTT...	22	22261	let-7d	Homo sapiens	Mature	0
TGAGGTAGTAGTTT...	22	19343	let-7g	Homo sapiens	Mature	0
TGAGGTAGTAGATT...	21	17831	let-7f-1//let-7f-2	Homo sapiens	Mature sub	0
ACTGGACTTGGAGT...	22	17132	mir-378	Homo sapiens	Mature super	0
TGAGGGGACAGAG...	23	14667	mir-423	Homo sapiens	Mature	0
AGCAGCATTGTACA...	23	14412	mir-103-2//mir-103-1	Homo sapiens	Mature	0
TGAGGTAGTAGATT...	23	14242	let-7f-2	Homo sapiens	Mature super	0

Figure 27.15: An ungrouped annotated sample.

are used for read mapping, the trimmed part of the read will automatically be removed. If all rows in the sample are selected and extracted, the sequence list would be the same as the input except for the reads that did not meet the adapter trim settings and the sampling thresholds (tag length and number of copies).

Extract Trimmed Reads (🔪) The same as above, except that the trimmed part has been removed.

Extract Small RNAs (📄) This will extract only one copy of each tag.

Note that for all these, you will be able to determine whether a list of DNA or RNA sequences should be produced (when working within the *CLC Genomics Workbench* environment, this only effects the RNA folding tools).

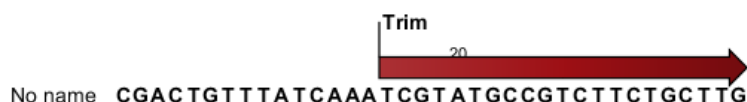

Figure 27.16: Extracting reads from a sample.

The button **Create Sample from Selection** (📁) can be used to create a new sample based on the tags that are selected. This can be useful in combination with filtering and sorting.

The grouped sample

An example of a grouped annotated sample is shown in figure 27.17.

The contents of the table are explained in section 27.1.3. In this section, we focus on the tools available for working with the sample.

By selecting one or more rows in the table, the buttons at the bottom of the view become active:

Open Read Mapping (🔍) This will open a view showing the annotation reference sequence at the top and the tags aligned to it as shown in figure 27.18. The names of the tags indicate their status compared with the reference (e.g. Mature 5', Mature super 5', Precursor).

Feature ID	Expression val...	Name	Resource	Exact mature	Mature	Unique exact m...	Unique mature
TGAGGTAGTAG...	18,868.00	let-7f-1//let-7f-2	Homo sapiens	4	18868	0	236
TGAGGTAGTAG...	7,917.00	let-7a-1//let-7a...	Homo sapiens	0	7917	0	5
TGAGGTAGTAG...	1,391.00	let-7i	Homo sapiens	0	1391	0	1387
ACTGGACTTGG...	1,008.00	mir-378	Homo sapiens	0	1008	0	1008
AGAGGTAGTA...	962.00	let-7d	Homo sapiens	0	962	0	945
TGAGGTAGGA...	893.00	let-7e	Homo sapiens	0	893	0	851
TGAGGTAGTAG...	874.00	let-7b	Homo sapiens	0	874	0	853
TGAGGTAGTAG...	874.00	let-7g	Homo sapiens	1	874	1	854
AGCAGCATTGT...	717.00	mir-103-2//mir...	Homo sapiens	0	717	0	5
TAGCACCATCT...	702.00	mir-29a	Homo sapiens	0	702	0	702
TGAGGGGCAG...	675.00	mir-423	Homo sapiens	0	675	0	675
AAAAGCTGGG...	549.00	mir-320a	Homo sapiens	0	549	0	547
TAGCTTATCAG...	484.00	mir-21	Homo sapiens	0	484	0	484
AGCTACATTGT...	348.00	mir-221	Homo sapiens	0	348	0	348
TTCCCTTTGTC...	285.00	mir-211	Homo sapiens	0	285	0	285
TCAGTGCATGA...	252.00	mir-152	Homo sapiens	0	252	0	252
TATTGCACCTT...	249.00	mir-92a-1//mir...	Homo sapiens	0	249	0	3
TACAGTACTCT...	243.00	mir-101-1//mir...	Homo sapiens	13	243	0	11

Figure 27.17: A sample grouped on mature 5' miRNAs.

This categorization is based on the choices you make when annotating. You can also see the annotations when using miRBase as the annotation source. In this example both the mature 5' and the mature 3' are annotated, and you can see that both are found in the sample. In the **Side Panel** to the right you can see the **Match weight** group under **Residue coloring** which is used to color the tags according to their relative abundance. The weight is also shown next to the name of the tag. The left side color is used for tags with low counts and the right side color is used for tags with high counts, relative to the total counts of this annotation reference. The sliders just above the gradient color box can be dragged to highlight relevant levels of abundance. The colors can be changed by clicking the box. This will show a list of gradients to choose from.

Create Sample from Selection (🗑️) This is used to create a new sample based on the tags that are selected. This can be useful in combination with filtering and sorting.

27.1.5 Exploring novel miRNAs

One way of doing this would be to identify interesting tags based on their counts (typically you would be interested in pursuing tags with not too low counts in order to avoid wasting efforts on tags based on reads with sequencing errors), **Extract Small RNAs** (🔍) and use this list of tags as input to **Map Reads to Reference** (📄) using the genome as reference. You could then examine where the reads match, and for reads that map in otherwise unannotated regions you could select a region around the match and create a subsequence from this. The subsequence could be folded and examined to see whether the secondary structure was in agreement with the expected hairpin-type structure for miRNAs. The *CLC Genomics Workbench* is able to analyze expression data produced on microarray platforms and high-throughput sequencing platforms (also known as Next-Generation Sequencing platforms). The *CLC Genomics Workbench* provides tools for performing quality control of the data, transformation and normalization, statistical analysis to measure differential expression and annotation-based tests. A number of visualization tools such as volcano plots, MA plots, scatter plots, box plots, and heat maps are used to aid the interpretation of the results.

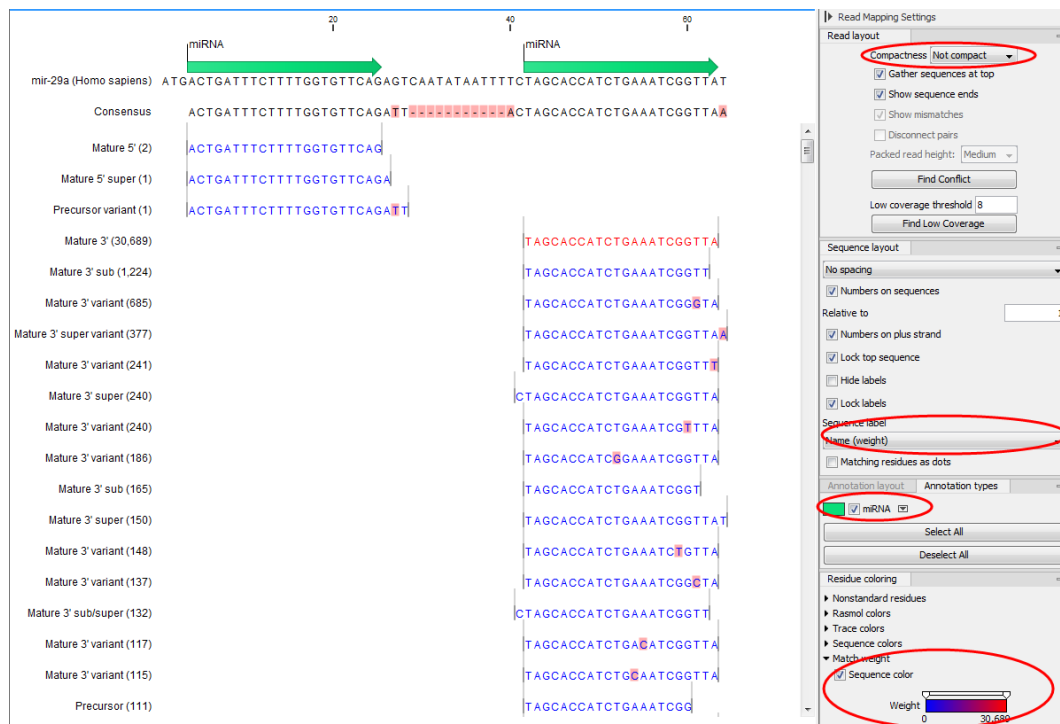

Figure 27.18: Aligning all the variants of this miRNA from miRBase, providing a visual overview of the distribution of tags along the precursor sequence.

27.2 Experimental design

In order to make full use of the various tools for interpreting expression data, you need to know the central concepts behind the way the data is organized in the *CLC Genomics Workbench*.

The first piece of data you are faced with is the **sample**. In the Workbench, a sample contains the expression values from either one array or from sequencing data of one sample.

Note that the calculation of expression levels based on the raw sequence data is described in section 26.1 and section 27.1.

See more below on how to get your expression data into the Workbench as samples in section K.

In a sample, there is a number of **features**, usually genes, and their associated expression levels.

To analyze differential expression, you need to tell the workbench how the samples are related. This is done by setting up an **experiment**. An experiment is essentially a set of samples which are grouped. By creating an experiment defining the relationship between the samples, it becomes possible to do statistical analysis to investigate differential expression between the groups. The **Experiment** is also used to accumulate calculations like t-tests and clustering because this information is closely related to the grouping of the samples.

27.2.1 Setting up an experiment

To set up an experiment:

Toolbox | Microarray and Small RNA Analysis (📁) | Set Up Experiment (🔧)

Select the samples that you wish to use by double-clicking or selecting and pressing the **Add** (➡) button (see figure 27.19).

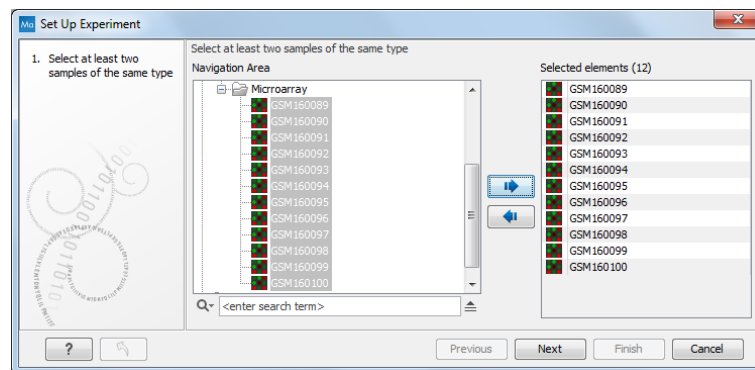

Figure 27.19: Select the samples to use for setting up the experiment.

Note that we use "samples" as the general term for both microarray-based sets of expression values and sequencing-based sets of expression values (e.g. an expression track from RNA-Seq).

Clicking **Next** shows the dialog in figure 27.20.

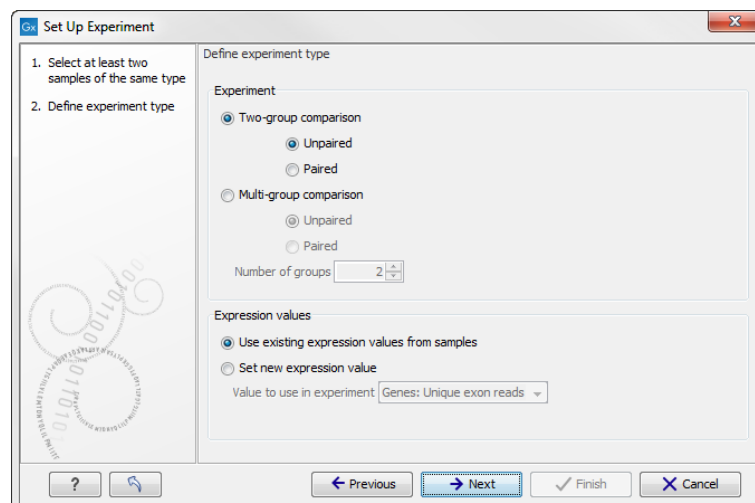

Figure 27.20: Defining the number of groups and expression value type.

Here you define the experiment type and the number of groups in the experiment.

The options are:

- **Experiment.** At the top you can select a two-group experiment, and below you can select a multi-group experiment and define the number of groups.

Note that you can also specify if the samples are paired. Pairing is relevant if you have samples from the same individual under different conditions, e.g. before and after treatment, or at times 0, 2, and 4 hours after treatment. In this case statistical analysis becomes more efficient if effects of the individuals are taken into account, and comparisons are carried out not simply by considering *raw* group means but by considering these *corrected for* effects of the individual. If **Paired** is selected, a paired rather than a standard t-test will be carried out for two group comparisons. For multiple group comparisons a repeated measures rather than a standard ANOVA will be used.

- **Expression values.** For RNA-Seq experiments, you can also choose which expression value to be used when setting up the experiment. This value will then be used for all subsequent analyses. If you choose to **Set new expression value** you can choose between the following options depending on whether you look at the gene or transcript level:
 - **Genes: Unique exon reads.** The number of reads that match uniquely to the exons (including the exon-exon and exon-intron junctions).
 - **Genes: Unique gene reads.** This is the number of reads that match uniquely to the gene.
 - **Genes: Total exon reads.** Number of reads mapped to this gene that fall entirely within an exon or in exon-exon or exon-intron junctions. As for the "Total gene reads" this includes both uniquely mapped reads and reads with multiple matches that were assigned to an exon of this gene.
 - **Genes: Total gene reads.** This is all the reads that are mapped to this gene, i.e., both reads that map uniquely to the gene and reads that matched to more positions in the reference (but fewer than the "Maximum number of hits for a read" parameter) which were assigned to this gene.
 - **Genes: RPKM.** This is the expression value measured in RPKM [Mortazavi et al., 2008]: $RPKM = \frac{\text{total exon reads}}{\text{mapped reads (millions)} \times \text{exon length (KB)}}$. See exact definition below. Even if you have chosen the RPKM values to be used in the **Expression values** column, they will also be stored in a separate column. This is useful to store the RPKM if you switch the expression measure. See more in section 26.1.4.
 - **Transcripts: Unique transcript reads.** This is the number of reads in the mapping for the gene that are uniquely assignable to the transcript. This number is calculated after the reads have been mapped and both single and multi-hit reads from the read mapping may be unique transcript reads.
 - **Transcripts: Total transcript reads.** Once the "Unique transcript read's" have been identified and their counts calculated for each transcript, the remaining (non-unique) transcript reads are assigned randomly to one of the transcripts to which they match. The "Total transcript reads" counts are the total number of reads that are assigned to the transcript once this random assignment has been done. As for the random assignment of reads among genes, the random assignment of reads within a gene but among transcripts, is done proportionally to the "unique transcript counts" normalized by transcript length, that is, using the RPKM. Unique transcript counts of 0 are not replaced by 1 for this proportional assignment of non-unique reads among transcripts.
 - **Transcripts: RPKM.** The RPKM value for the transcript, that is, the number of reads assigned to the transcript divided by the transcript length and normalized by "Mapped reads" (see below).

Clicking **Next** shows the dialog in figure 27.21.

Depending on the number of groups selected in figure 27.20, you will see a list of groups with text fields where you can enter an appropriate name for that group.

For multi-group experiments, if you find out that you have too many groups, click the **Delete** (X) button. If you need more groups, simply click **Add New Group**.

Click **Next** when you have named the groups, and you will see figure 27.22.

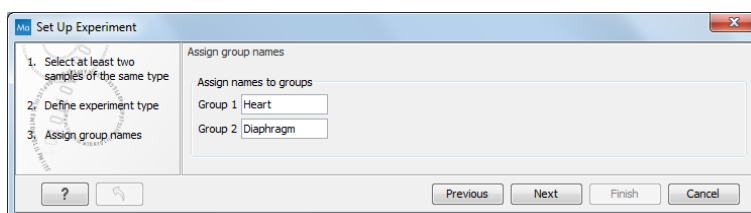

Figure 27.21: Naming the groups.

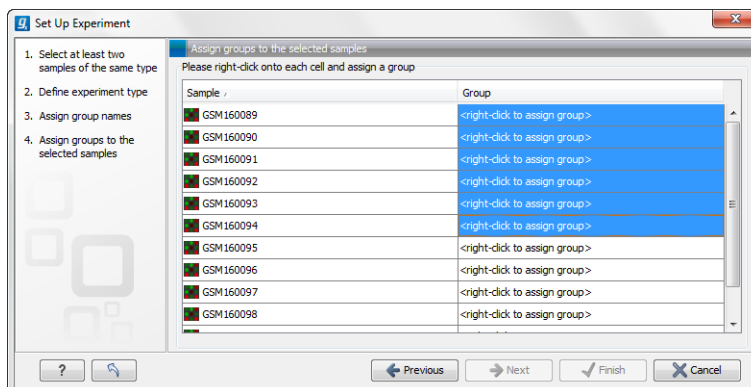

Figure 27.22: Putting the samples into groups.

This is where you define which group the individual sample belongs to. Simply select one or more samples (by clicking and dragging the mouse), right-click (Ctrl-click on Mac) and select the appropriate group.

Note that the samples are sorted alphabetically based on their names.

If you have chosen **Paired** in figure 27.20, there will be an extra column where you define which samples belong together. Just as when defining the group membership, you select one or more samples, right-click in the pairing column and select a pair.

Click **Next** if you wish to adjust how to handle the results (see section 8.2). If not, click **Finish**.

27.2.2 Organization of the experiment table

The resulting experiment includes all the expression values and other information from the samples (the values are copied - the original samples are not affected and can thus be deleted with no effect on the experiment). In addition it includes a number of summaries of the values across all, or a subset of, the samples for each feature. Which values are included is described in the sections below.

When you open it, it is shown in the experiment table (see figure 27.23).

For a general introduction to table features like sorting and filtering, see section 3.3.

Unlike other tables in *CLC Genomics Workbench*, the experiment table has a hierarchical grouping of the columns. This is done to reflect the structure of the data in the experiment. The **Side Panel** is divided into a number of groups corresponding to the structure of the table. These are described below. Note that you can customize and save the settings of the **Side Panel** (see section 4.6).

Whenever you perform analyses like normalization, transformation, statistical analysis etc, new columns will be added to the experiment. You can at any time **Export** (📄) all the data in the

The screenshot shows a software window titled 'brain vs. liver' with 31763 rows. A table displays experimental data for various feature IDs. The table columns are: Feature ID, Range (original values), IQR (original values), Difference, and Fold Change. A side panel titled 'Experiment Table 5...' provides options for column width (Manual), experiment level, analysis level, annotation level, group level (with checkboxes for brain, liver, and Means), and sample level. Buttons for 'Select All' and 'Deselect All' are visible under the group level section.

Feature ID	Experiment				Express
	Range (orig...)	IQR (origin...)	Difference (...)	Fold Chang...	
0610006I08...	19,92	16,78	-17,68	-1,61	
0610006L0...	0,00	0,00	0,00	1,00	
0610007C2...	26,01	25,89	25,34	1,50	
0610007L0...	6,41	5,74	5,92	1,41	
0610007N1...	1,18	0,97	-1,04	-3,09	
0610007P0...	-∞	0,28	0,44	1,54	
0610007P1...	2,87	1,97	-2,34	-1,08	
0610007P2...	10,52	6,76	-7,33	-1,67	
0610008C0...	2,41	2,41	1,71	1,27	
0610009B2...	-∞	6,39	4,47	1,33	
0610009D0...	0,70	0,29	0,48	1,03	
0610009K1...	13,42	12,57	-12,51	-2,20	
0610009O0...	6,08	5,76	-5,60	-5,03	
0610009O2...	9,88	7,61	-8,06	-1,69	

Figure 27.23: Opening the experiment.

experiment in csv or Excel format or **Copy** (□) the full table or parts of it. For more information on visualizing RNA-Seq read tracks from the experiment, see section 27.3.5.

Column width

There are two options to specify the width of the columns and also the entire table:

- **Automatic.** This will fit the entire table into the width of the view. This is useful if you only have a few columns.
- **Manual.** This will adjust the width of all columns evenly, and it will make the table as wide as it needs to be to display all the columns. This is useful if you have many columns. In this case there will be a scroll bar at the bottom, and you can manually adjust the width by dragging the column separators.

Experiment level

The rest of the **Side Panel** is devoted to different levels of information on the values in the experiment. The experiment part contains a number of columns that, for each feature ID, provide summaries of the values across all the samples in the experiment (see figure 27.24).

Initially, it has one header for the whole **Experiment**:

- **Range (original values).** The 'Range' column contains the difference between the highest

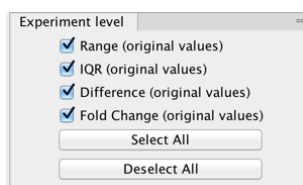

Figure 27.24: The initial view of the experiment level for a two-group experiment.

and the lowest expression value for the feature over all the samples. If a feature has the value NaN in one or more of the samples the range value is NaN.

- IQR (original values).** The 'IQR' column contains the inter-quantile range of the values for a feature across the samples, that is, the difference between the 75 %-ile value and the 25 %-ile value. For the IQR values, only the numeric values are considered when percentiles are calculated (that is, NaN and +Inf or -Inf values are ignored), and if there are fewer than four samples with numeric values for a feature, the IQR is set to be the difference between the highest and lowest of these.
- Difference (original values).** For a two-group experiment the 'Difference' column contains the difference between the mean of the expression values across the samples assigned to group 2 and the mean of the expression values across the samples assigned to group 1. Thus, if the mean expression level in group 2 is higher than that of group 1 the 'Difference' is positive, and if it is lower the 'Difference' is negative. For experiments with more than two groups the 'Difference' contains the difference between the maximum and minimum of the mean expression values of the groups, multiplied by -1 if the group with the maximum mean expression value occurs before the group with the minimum mean expression value (with the ordering: group 1, group 2, ...).
- Fold Change (original values).** For a two-group experiment the 'Fold Change' tells you how many times bigger the mean expression value in group 2 is relative to that of group 1. If the mean expression value in group 2 is bigger than that in group 1 this value is the mean expression value in group 2 divided by that in group 1. If the mean expression value in group 2 is smaller than that in group 1 the fold change is the mean expression value in group 1 divided by that in group 2 with a negative sign. Thus, if the mean expression levels in group 1 and group 2 are 10 and 50 respectively, the fold change is 5, and if the and if the mean expression levels in group 1 and group 2 are 50 and 10 respectively, the fold change is -5. Entries of plus or minus infinity in the 'Fold Change' columns of the Experiment area represent those where one of the expression values in the calculation is a 0. For experiments with more than two groups, the 'Fold Change' column contains the ratio of the maximum of the mean expression values of the groups to the minimum of the mean expression values of the groups, multiplied by -1 if the group with the maximum mean expression value occurs before the group with the minimum mean expression value (with the ordering: group 1, group 2, ...).

Thus, the sign of the values in the 'Difference' and 'Fold change' columns give the direction of the trend across the groups, going from group 1 to group 2, etc.

If the samples used are Affymetrix GeneChips samples and have 'Present calls' there will also be a 'Total present count' column containing the number of present calls for all samples.

The columns under the 'Experiment' header are useful for filtering purposes, e.g. you may wish to ignore features that differ too little in expression levels to be confirmed e.g. by qPCR by

filtering on the values in the 'Difference', 'IQR' or 'Fold Change' columns or you may wish to ignore features that do not differ at all by filtering on the 'Range' column.

If you have performed normalization or transformation (see sections 27.4.3 and 27.4.2, respectively), the IQR of the normalized and transformed values will also appear. Also, if you later choose to transform or normalize your experiment, columns will be added for the transformed or normalized values.

Note! It is very common to filter features on fold change values in expression analysis and fold change values are also used in volcano plots, see section 27.6.5. There are different definitions of 'Fold Change' in the literature. The definition that is used typically depends on the original scale of the data that is analyzed. For data whose original scale is *not* the log scale the standard definition is the ratio of the group means [Tusher et al., 2001]. This is the value you find in the 'Fold Change' column of the experiment. However, for data whose original *is* the log scale, the difference of the mean expression levels is sometimes referred to as the fold change [Guo et al., 2006], and if you want to filter on fold change for these data you should filter on the values in the 'Difference' column. Your data's original scale will e.g. be the log scale if you have imported Affymetrix expression values which have been created by running the RMA algorithm on the probe-intensities.

Analysis level

The results of each statistical test performed are in the columns listed in this area. In the table, a heading is given for each test. Information about the results of statistical tests are described in the statistical analysis section (see section 27.6).

An example of Analysis level settings is shown in figure 27.25.

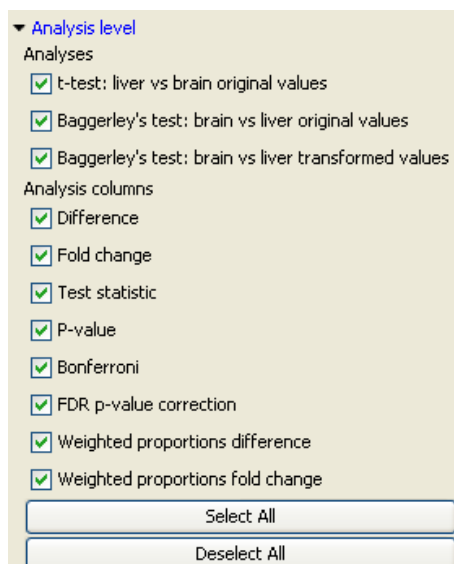

Figure 27.25: An example of columns available under the Analysis level section.

Note: Some column names here are the same as ones under the Experiment level, but the results here are from statistical tests, while those under the Experiment level section are calculations carried out directly on the expression levels.

Annotation level

If your experiment is annotated (see section 27.2.3), the annotations will be listed in the **Annotation level** group as shown in figure 27.26.

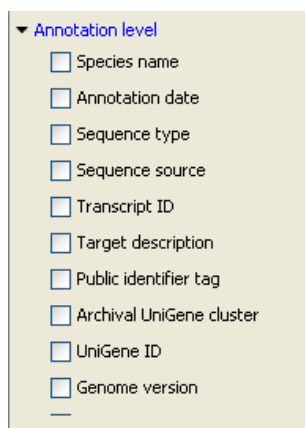

Figure 27.26: An annotated experiment.

In order to avoid too much detail and cluttering the table, only a few of the columns are shown per default.

Note that if you wish a different set of annotations to be displayed each time you open an experiment, you need to save the settings of the **Side Panel** (see section 4.6).

Group level

At the group level, you can show/hide entire groups (*Heart* and *Diaphragm* in figure 27.23). This will show/hide everything under the group's header. Furthermore, you can show/hide group-level information like the group means and present count within a group. If you have performed normalization or transformation (see sections 27.4.3 and 27.4.2, respectively), the means of the normalized and transformed values will also appear.

Sample level

In this part of the side panel, you can control which columns to be displayed for each sample. Initially this is the all the columns in the samples.

If you have performed normalization or transformation (see sections 27.4.3 and 27.4.2, respectively), the normalized and transformed values will also appear.

An example is shown in figure 27.27.

Creating a sub-experiment from a selection

If you have identified a list of genes that you believe are differentially expressed, you can create a subset of the experiment. (Note that the filtering and sorting may come in handy in this situation, see section 3.3).

To create a sub-experiment, first select the relevant features (rows). If you have applied a filter and wish to select all the visible features, press Ctrl + A (⌘ + A on Mac). Next, press the **Create**

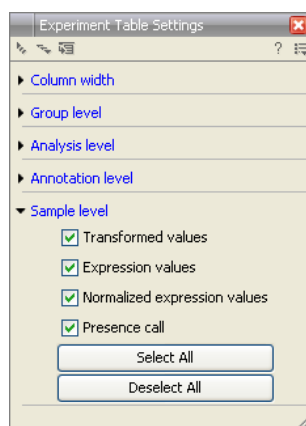



Figure 27.27: Sample level when transformation and normalization has been performed.

Experiment from Selection () button at the bottom of the table (see figure 27.28).

1	1160	186	341	175	330
1	1212	100	794	85	767
1	795	506	559	498	549
1	1116	427	438	421	422
1	3732	965	970	930	934
1	1827	68	68	64	64
1	2391	1840	1874	1816	1846
1	1635	28	35	14	14
1	6292	715	740	626	630





Buttons:  Add Annotations  Create Experiment from Selection  Download Sequence

Figure 27.28: Create a subset of the experiment by clicking the button at the bottom of the experiment table.

This will create a new experiment that has the same information as the existing one but with less features.

Downloading sequences from the experiment table

If your experiment is annotated, you will be able to download the GenBank sequence for features which have a GenBank accession number in the 'Public identifier tag' annotation column. To do this, select a number of features (rows) in the experiment and then click **Download Sequence** () (see figure 27.29).

1	1160	186	341	175	330
1	1212	100	794	85	767
1	795	506	559	498	549
1	1116	427	438	421	422
1	3732	965	970	930	934
1	1827	68	68	64	64
1	2391	1840	1874	1816	1846
1	1635	28	35	14	14
1	6292	715	740	626	630



Buttons:  Add Annotations  Create Experiment from Selection  Download Sequence

Figure 27.29: Select sequences and press the download button.

This will open a dialog where you specify where the sequences should be saved. You can learn more about opening and viewing sequences in chapter 10. You can now use the downloaded sequences for further analysis in the Workbench.

27.2.3 Adding annotations to an experiment

Annotation files provide additional information about each feature. This information could be which GO categories the protein belongs to, which pathways, various transcript and protein identifiers etc. See section K for information about the different annotation file formats that are supported *CLC Genomics Workbench*.

The annotation file can be imported into the Workbench and will get a special icon (📄). See an overview of annotation formats supported by *CLC Genomics Workbench* in section K. In order to associate an annotation file with an experiment, either select the annotation file when you set up the experiment (see section 27.2.1), or click:

Toolbox | Microarray and Small RNA Analysis (📄) | Annotation Test | Add Annotations (📄)

Select the experiment (📄) and the annotation file (📄) and click **Finish**. You will now be able to see the annotations in the experiment as described in section 27.2.2. You can also add annotations by pressing the **Add Annotations (📄)** button at the bottom of the table (see figure 27.30).

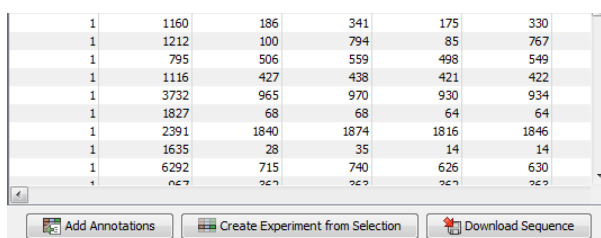

1	1160	186	341	175	330
1	1212	100	794	85	767
1	795	506	559	498	549
1	1116	427	438	421	422
1	3732	965	970	930	934
1	1827	68	68	64	64
1	2391	1840	1874	1816	1846
1	1635	28	35	14	14
1	6292	715	740	626	630
+	667	667	667	667	667

Buttons: Add Annotations, Create Experiment from Selection, Download Sequence

Figure 27.30: Adding annotations by clicking the button at the bottom of the experiment table.

This will bring up a dialog where you can select the annotation file that you have imported together with the experiment you wish to annotate. Click **Next** to specify settings as shown in figure 27.31).

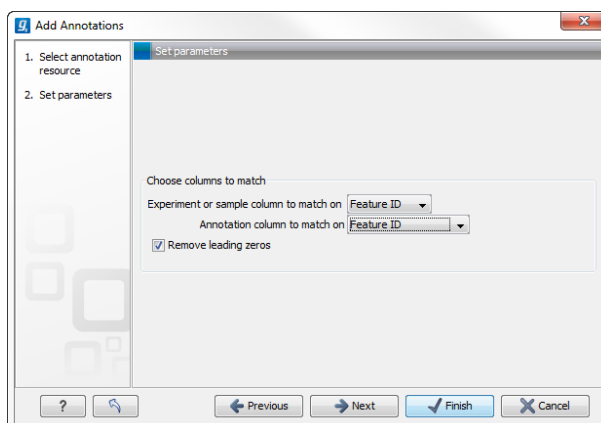

Add Annotations

1. Select annotation resource

2. Set parameters

Set parameters

Choose columns to match

Experiment or sample column to match on: Feature ID

Annotation column to match on: Feature ID

Remove leading zeros

Buttons: Previous, Next, Finish, Cancel

Figure 27.31: Choosing how to match annotations with samples.

In this dialog, you can specify how to match the annotations to the features in the sample. The Workbench looks at the columns in the annotation file and lets you choose which column that should be used for matching to the feature IDs in the experimental data (experiment or sample) as well as for the annotations. Usually the default is right, but for some annotation files, you need to select another column.

Some annotation files have leading zeros in the identifier which you can remove by checking the **Remove leading zeros** box.

Note! Existing annotations on the experiment will be overwritten.

27.2.4 Scatter plot view of an experiment

At the bottom of the experiment table, you can switch between different views of the experiment (see figure 27.32).



Figure 27.32: An experiment can be viewed in several ways.

One of the views is the **Scatter Plot** (📊). The scatter plot can be adjusted to show e.g. the group means for two groups (see more about how to adjust this below).

An example of a scatter plot is shown in figure 27.33.

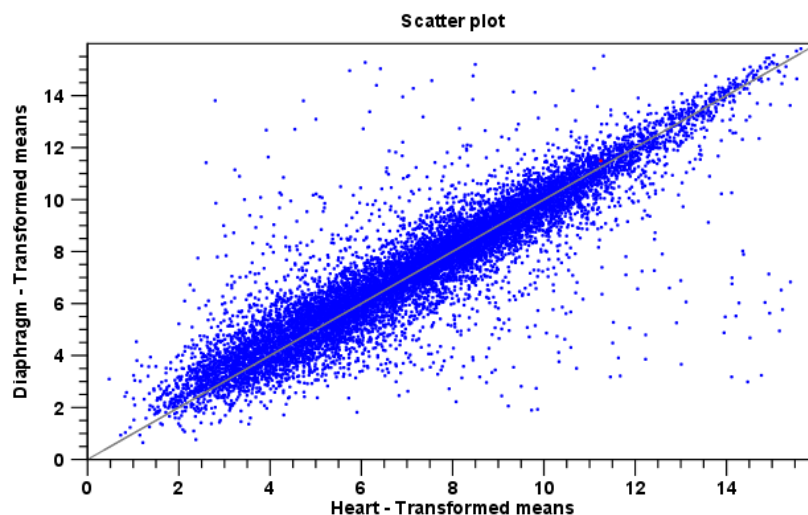

Figure 27.33: A scatter plot of group means for two groups (transformed expression values).

In the **Side Panel** to the left, there are a number of options to adjust this view. Under **Graph preferences**, you can adjust the general properties of the scatter plot:

- **Lock axes** This will always show the axes even though the plot is zoomed to a detailed level.
- **Frame** Shows a frame around the graph.
- **Show legends** Shows the data legends.
- **Tick type** Determine whether tick lines should be shown outside or inside the frame.
 - Outside
 - Inside

- **Tick lines at** Choosing Major ticks will show a grid behind the graph.
 - None
 - Major ticks
- **Horizontal axis range** Sets the range of the horizontal axis (x axis). Enter a value in **Min** and **Max**, and press Enter. This will update the view. If you wait a few seconds without pressing Enter, the view will also be updated.
- **Vertical axis range** Sets the range of the vertical axis (y axis). Enter a value in **Min** and **Max**, and press Enter. This will update the view. If you wait a few seconds without pressing Enter, the view will also be updated.
- **Draw x = y axis.** This will draw a diagonal line across the plot. This line is shown per default.
- **Line width**
 - Thin
 - Medium
 - Wide
- **Line type**
 - None
 - Line
 - Long dash
 - Short dash
- **Line color.** Allows you to choose between many different colors. Click the color box to select a color.
- **Show Pearson correlation** When checked, the Pearson correlation coefficient (r) is displayed on the plot.

Below the general preferences, you find the **Dot properties** preferences, where you can adjust coloring and appearance of the dots:

- **Dot type**
 - None
 - Cross
 - Plus
 - Square
 - Diamond
 - Circle
 - Triangle
 - Reverse triangle

– Dot

- **Dot color.** Allows you to choose between many different colors. Click the color box to select a color.

Finally, the group at the bottom - **Values to plot** - is where you choose the values to be displayed in the graph. The default for a two-group experiment is to plot the group means.

Note that if you wish to use the same settings next time you open a scatter plot, you need to save the settings of the **Side Panel** (see section 4.6).

27.2.5 Cross-view selections

There are a number of different ways of looking at an experiment as shown in figure 27.34).

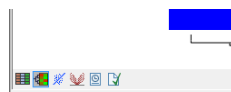

Figure 27.34: An experiment can be viewed in several ways.

Beside the **Experiment table** (📄) which is the default view, the views are: **Scatter plot** (📊), **Volcano plot** (🌋) and the **Heat map** (🔥). By pressing and holding the Ctrl (⌘ on Mac) button while you click one of the view buttons in figure 27.34, you can make a split view. This will make it possible to see e.g. the experiment table in one view and the volcano plot in another view.

An example of such a split view is shown in figure 27.35.

Selections are shared between all these different views of an experiment. This means that if you select a number of rows in the table, the corresponding dots in the scatter plot, volcano plot or heatmap will also be selected. The selection can be made in any view, also the heat map, and all other open views will reflect the selection.

A common use of the split views is where you have an experiment and have performed a statistical analysis. You filter the experiment to identify all genes that have an FDR corrected p-value below 0.05 and a fold change for the test above say, 2. You can select all the rows in the experiment table satisfying these filters by holding down the Cntrl button and clicking 'a'. If you have a split view of the experiment and the volcano plot all points in the volcano plot corresponding to the selected features will be red. Note that the volcano plot allows two sets of values in the columns under the test you are considering to be displayed on the x-axis: the 'Fold change's and the 'Difference's. You control which to plot in the side panel. If you have filtered on 'Fold change' you will typically want to choose 'Fold change' in the side panel. If you have filtered on 'Difference' (e.g. because your original data is on the log scale, see the note on fold change in 27.2.2) you typically want to choose 'Difference'.

27.3 Working with tracks and experiments

The *CLC Genomics Workbench* provides several tools for the analysis, organization, and visualization of expression data. In this section, we describe how Tracks and Experiments complement each other, and how they can be used together for the analysis of transcriptomics data.

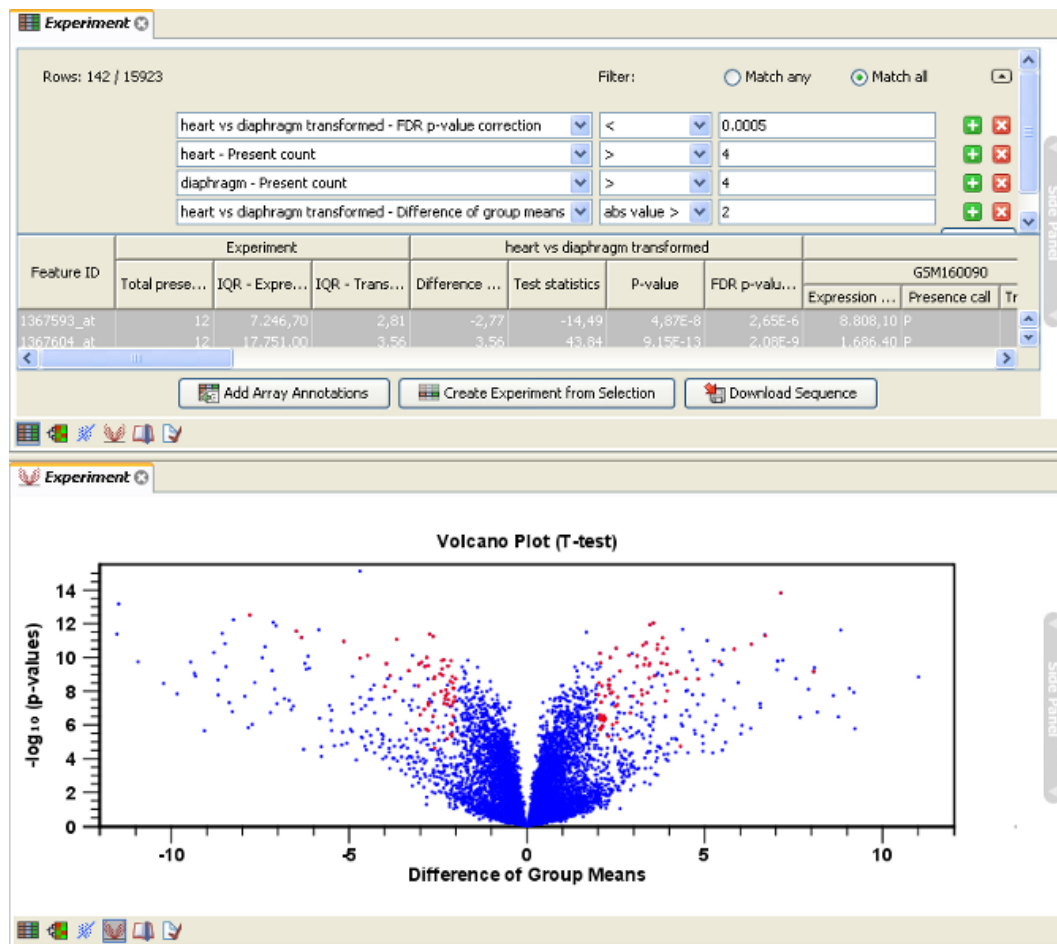

Figure 27.35: A split view showing an experiment table at the top and a volcano plot at the bottom (note that you need to perform statistical analysis to show a volcano plot, see section 27.6).

27.3.1 Data structures for transcriptomics

The two main data structures used for transcriptomics data analysis in the *CLC Genomics Workbench* are tracks and experiments.

Tracks (see section 23) are the fundamental building blocks for data analysis in the *CLC Genomics Workbench*, where all information is tied to genomic positions. A central coordinate-system is provided by a reference genome, which allows that different types of data or results for different samples can be seen and analyzed together.

Experiments (see section 27.2), on the other hand, are used to represent complex relationships between expression samples, and to carry out statistical analysis (see section 27.6) of differential expression.

Tracks and experiments are intimately related, and it is possible in most cases to convert from one type to the other.

From Tracks to Experiments

When carrying out RNA-seq analysis using the **RNA-Seq Analysis** tool, the starting point is a set of reads from a sequencing study. As part of the RNA-Seq Analysis tool, these reads are mapped

onto a reference genome. The RNA-Seq tool produces expression tracks, which are compatible with the reference genome, and can be visualized together with the genome in the **Track List View** (see section 23).

You can find more information about the RNA-Seq Analysis tool in section 26.1.

Once expression tracks have been obtained from the RNA-Seq Analysis tool, they can be used as sequencing-based sets of expression values in setting up an experiment. This can be done using the **Set up Experiment** tool and it is described in more detail in section 27.2.

1. Use the **Set up Experiment** tool on two or more expression tracks to set up an experiment, as described in section 27.2.
2. Save and open the resulting experiment, by double-clicking its name in the **Navigation Area**.
3. Use the **Create Track List** tool to create a track list from the expression tracks you used to set up the experiment, as described in section 23.
4. Save and open the resulting track list by double-clicking its name in the **Navigation Area**.
5. Drag the experiment tab downwards, until you see the blue shadow indicating the resulting placement (figure 27.36), and drop it in place. You should now have a divided view, with the experiment in the bottom half (figure 27.37).
6. Clicking on any line in the experiment will now automatically jump to the corresponding genomic location in the upper view. Use the **Zoom to Selection** () button to zoom in to the desired genomic region.

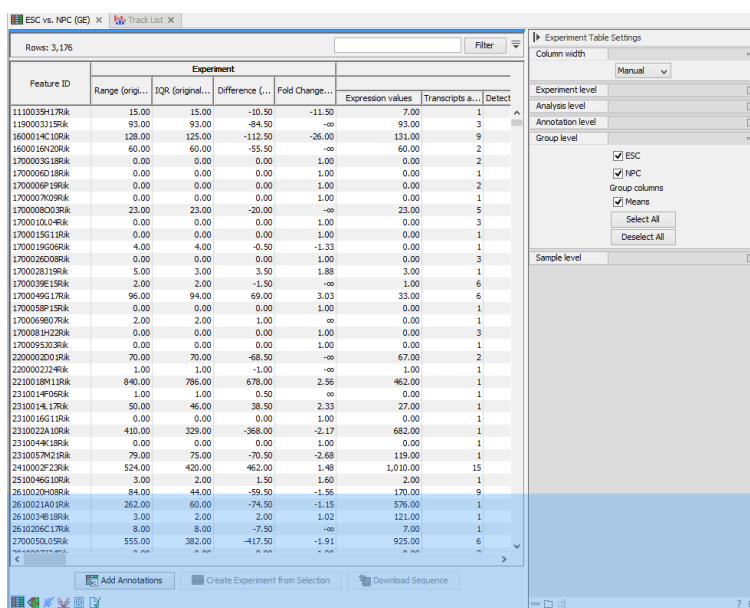

Feature ID	Experiment				Expression values	Transcripts a...	Detect
	Range (origi...	IQR (original...	Difference (...	Fold Change...			
1110039117Rik	15.00	15.00	-10.50	-11.50	7.00	1	
1190003115Rik	93.00	93.00	-84.50	-	93.00	3	
1600014C10Rik	128.00	125.00	-112.50	-26.00	131.00	9	
1600018K02Rik	60.00	60.00	-55.50	-	60.00	2	
1700003318Rik	0.00	0.00	0.00	1.00	0.00	2	
1700006018Rik	0.00	0.00	0.00	1.00	0.00	1	
1700006019Rik	0.00	0.00	0.00	1.00	0.00	2	
1700007030Rik	0.00	0.00	0.00	1.00	0.00	1	
1700009030Rik	23.00	23.00	-20.00	-	23.00	5	
1700010L04Rik	0.00	0.00	0.00	1.00	0.00	3	
1700015G11Rik	0.00	0.00	0.00	1.00	0.00	1	
1700019G06Rik	4.00	4.00	-0.50	-1.33	0.00	1	
1700026G08Rik	0.00	0.00	0.00	1.00	0.00	3	
1700028119Rik	5.00	3.00	3.50	1.88	3.00	1	
1700039E15Rik	2.00	2.00	-1.50	-	1.00	6	
1700049G17Rik	96.00	94.00	69.00	3.03	33.00	6	
1700058R15Rik	0.00	0.00	0.00	1.00	0.00	1	
1700069070Rik	2.00	2.00	1.00	-	0.00	1	
1700081H22Rik	0.00	0.00	0.00	1.00	0.00	3	
1700093030Rik	0.00	0.00	0.00	1.00	0.00	1	
2200000201Rik	70.00	70.00	-68.50	-	67.00	2	
2200001214Rik	1.00	1.00	-1.00	-	1.00	1	
2210018M11Rik	840.00	786.00	678.00	2.56	462.00	1	
2310014F06Rik	1.00	1.00	0.50	-	0.00	1	
2310014L17Rik	50.00	46.00	38.50	2.33	27.00	1	
2310016G11Rik	0.00	0.00	0.00	1.00	0.00	1	
2310022A10Rik	410.00	329.00	-368.00	-2.17	682.00	1	
2310044K18Rik	0.00	0.00	0.00	1.00	0.00	1	
2310057M21Rik	79.00	75.00	-70.50	-2.68	119.00	1	
2410020212Rik	524.00	420.00	462.00	1.48	1,010.00	15	
2510046G10Rik	3.00	2.00	1.50	1.60	2.00	1	
2610020H08Rik	84.00	44.00	-59.50	-1.56	170.00	9	
2610021A01Rik	262.00	60.00	-74.50	-1.15	576.00	1	
2610034G18Rik	3.00	2.00	2.00	1.02	121.00	1	
2610205C17Rik	8.00	8.00	-7.50	-	7.00	1	
2700050L05Rik	555.00	382.00	-417.50	-1.91	925.00	6	

Figure 27.36: Dragging a tab to the lower half of the view area.

27.3.2 From Experiments to Tracks

Experiments can be used to carry out statistical analysis on the expression values obtained from RNA-seq analysis as described in section 27.6. The results of the statistical analysis are annotated on the experiment as additional columns.

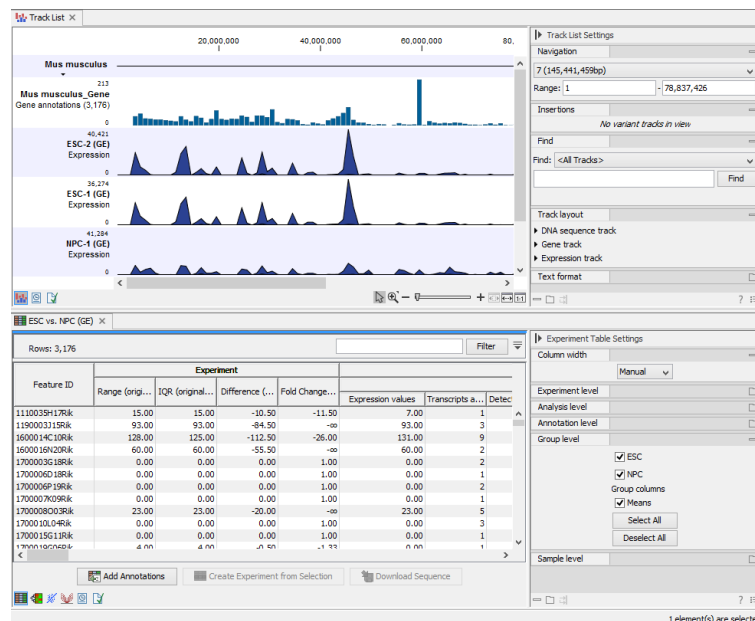

Figure 27.37: After dropping a tab to the lower half of the view area.

It can be advantageous to visualize the results of the statistical analysis as tracks. The **Create Track from Experiment** tool in the *CLC Genomics Workbench* enables the conversion of experiments to tracks.

27.3.3 Running the Create Track from Experiment tool

You can find the **Create Track from Experiment** tool here:

Toolbox | Microarray and Small RNA Analysis | Create Track from Experiment  .

After you start the tool, you are presented with a wizard where you can choose the experiment that you would like to create a track of. The **Create Track from Experiment** tool can be run on experiments with associated genomic information, such as those created using expression tracks from the **RNA-Seq Analysis** tool.

In the case where the experiment has associated genomic information, the **Create Track from Experiment** tool will automatically infer these and the wizard will jump directly to the filtering step, as shown in figure 27.39.

In the case where the experiment does not have associated genomic information, you will first need to specify how the genomic information should be obtained in the parameters step of the **Create Track from Experiment** tool (figure 27.38).

In the Input parameters step, you must specify the following parameters:

- **Reference genome.** The chosen genome will be used as the reference genome for the resulting track.
- **Chromosome column.** The column containing the chromosome names must be chosen from the drop-down menu.
- **Chromosomal region start.** The column containing the start of the genomic regions must be chosen from the drop-down menu.

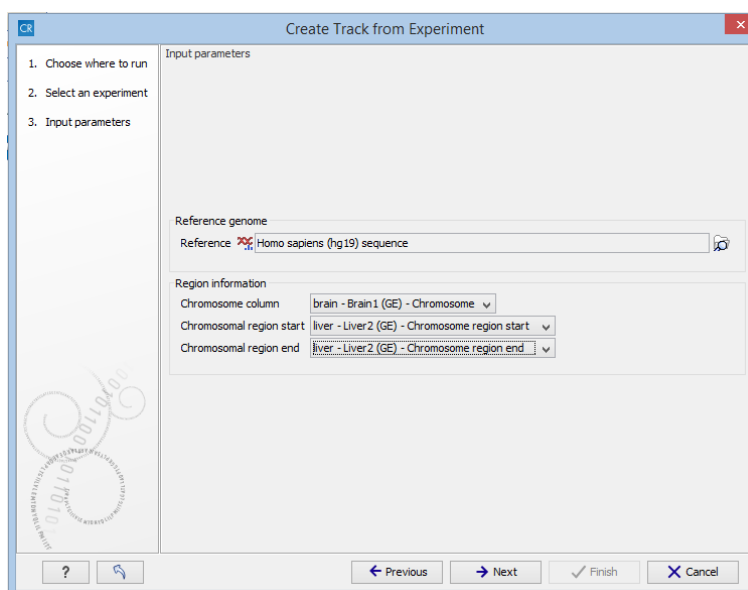

Figure 27.38: The "Input parameters" step in the Create Track from Experiment tool.

- **Chromosomal region end.** The column containing the end of the genomic regions must be chosen from the drop-down menu.

Note! The drop-down menus will only contain the columns that potentially represent the information required by the given parameter. If the experiment does not contain any columns that potentially represent the required genomic information, the drop-down menus may appear empty. In this case, it is not possible to convert the given experiment to a track.

In the filtering step (figure 27.39), you have the following options:

- **Filter based on statistical analysis results** This allows to filter which annotations are transferred to the track on the basis of the statistical analysis. To enable filtering, check the **Filter based on statistical analysis results** checkbox. The filtering option is only available if a statistical analysis has previously been carried out on the experiment, and the drop-down menu will only contain the statistical analyses that are present on the experiment.
- **Statistical analysis** Allows you to choose statistical analysis from the drop-down list. The selection of available statistical analyses depends on which tests have been used when you set up the experiment that you are about to convert to track format.
- **Type of p-value** This drop-down menu allows you to select between raw and corrected p-values (see section 27.6.4). Only the types of p-values available for the given statistical analysis will be present in the drop-down menu.
- **Maximum p-value** In this input field, you can enter the maximum allowed p-value, as a number between 0 and 1. If you do not want any filtering based on p-value, enter 1.
- **Minimum fold-change value** You can also specify the minimum allowed fold-change value as a number greater than zero. If you do not want any filtering based on fold-change, enter 0.

You can then select in the drop-down menu which analysis you want to use for filtering.

The fold change values are stored as different columns in the experiment, depending on the statistical analysis performed. The Create Track from Experiment tool will automatically use the fold-change column appropriate for the different statistical analyses:

- Kal's Z-test (see section 27.6.2): Proportions fold change.
- Baggerley's test(see section 27.6.2): Weighted proportions fold change.
- T-test (see section 27.6.3): Fold change.
- ANOVA (see section 27.6.3): Max fold change.
- Empirical analysis of DGE (see section 27.6.1): Fold change.

The resulting track will contain only differentially expressed genes whose p-value is lower than the specified threshold and whose fold-enrichment is above the specified threshold.

If the chosen statistical analysis was performed on several pairs of groups, there will be an output track for each tested pair of groups. For example, if the same statistical analysis has been carried out on 'group 1 vs. group 2' and 'group 1 vs. group 3', then the output will contain two tracks, where one is filtered according to the 'group 1 vs. group 2' analysis results and the other one is filtered according to the 'group 1 vs. group 3' analysis results.

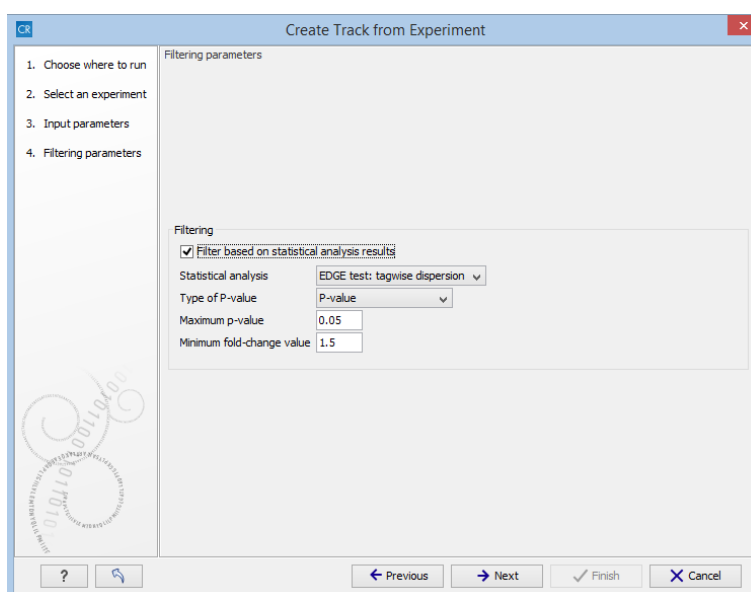

Figure 27.39: The filtering step in the Create Track from Experiment tool.

When running the **Create Track from Experiment** tool as part of a workflow, there are a few differences in how the parameters are set (see figure 27.41).

- The **Source of genomic information** parameter determines the behavior of the algorithm if the incoming experiment is *not* coupled to a genome. If the value of this parameter is set to **Require genomic information in experiment**, then the algorithm will expect the incoming experiment to be coupled to a genome, and will fail with an error alerting the user in case the experiment does not fulfill this criterion. If the value of the parameter is

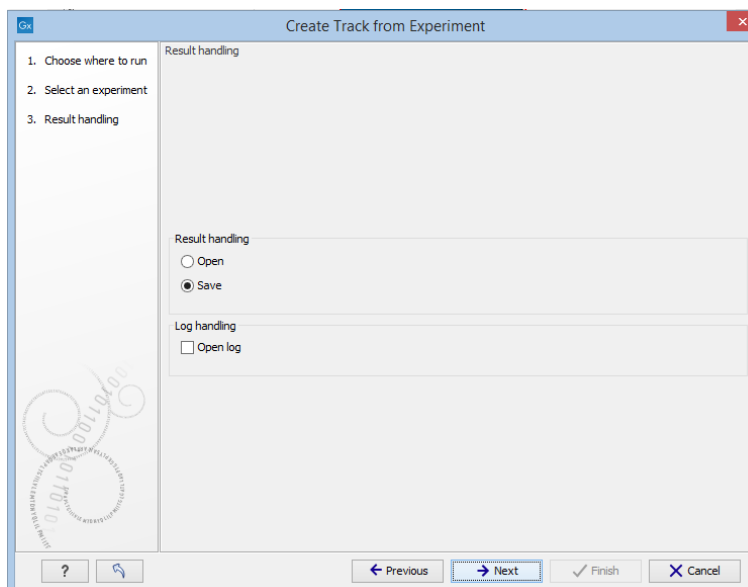

Figure 27.40: The result handling step in the Create Track from Experiment tool.

set to **Automatic: use genomic information if available**, then the algorithm will still use the genomic information in a genome-coupled experiment. But if this information is not available, the algorithm will attempt to use the information specified by the user in the workflow parameters. *Note:* If the incoming experiment is coupled to a genome (as will usually be the case), the value of this parameter makes no difference.

- In a workflow setting, the column titles for the chromosome, region end and region start fields can be specified as texts. These fields may be left empty, if the incoming experiment contains the genomic information. If filling out these fields, note that the format for this text is very strict, and must exactly match the text appearing in the drop-down menu when running the tool from the toolbox. For example, if 'Chromosome' is a sample-specific column, for a sample called 'Liver (GE)' in the 'liver' group in the experiment, then the column name text will be: 'liver - Liver (GE) - Chromosome'.

27.3.4 Interpreting the results of the Create Track from Experiment tool

The **Create Track from Experiment** tool will produce a track or several tracks, if filtering based on analysis results was chosen. The track(s) will contain the following annotations:

- All experiment-specific columns from the experiment
- All user-defined annotations added to the experiment
- All analysis-specific columns from the experiment
- All group-specific columns from the experiment
- Those of the following sample-specific columns when present in the experiment (for each sample): Expression values, Total exon reads, and RPKM.

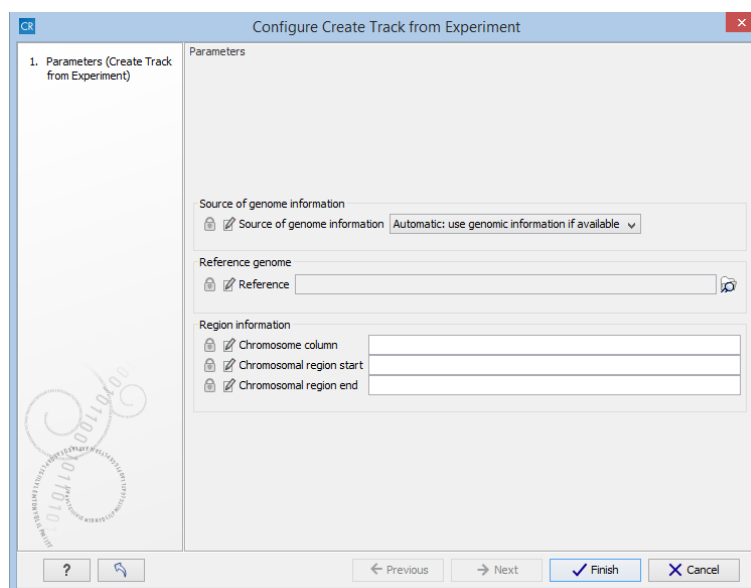

Figure 27.41: Setting the parameters for the Create Track from Experiment tool in a workflow

Two different view options exist: the Track List and the Table View. When opening the annotated output result, the default view is the Track List. It is possible to open both views in split view by holding down the Ctrl key while clicking on the table icon in the lower left corner of the View Area. The two different views are linked together. This means that when you click once on an entry in the table, the Track List will jump the selected region. With the **Zoom to Selection** (🔍) button it is possible to jump to and zoom in on the selected region (figure 27.42).

The results of any statistical test executed on the experiment, including fold-changes and p-values, can be seen in the tooltip when hovering over each region in the annotation track shown in the Track List (figure 27.43).

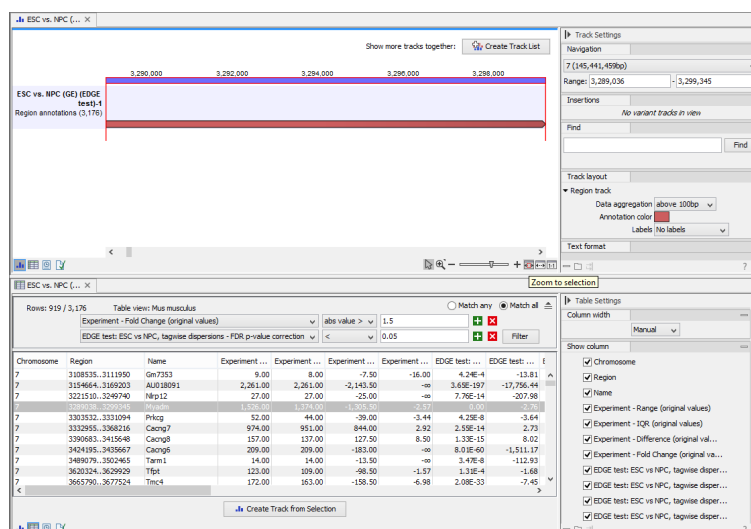

Figure 27.42: Viewing the track produced by the Create Track from Experiment Tool

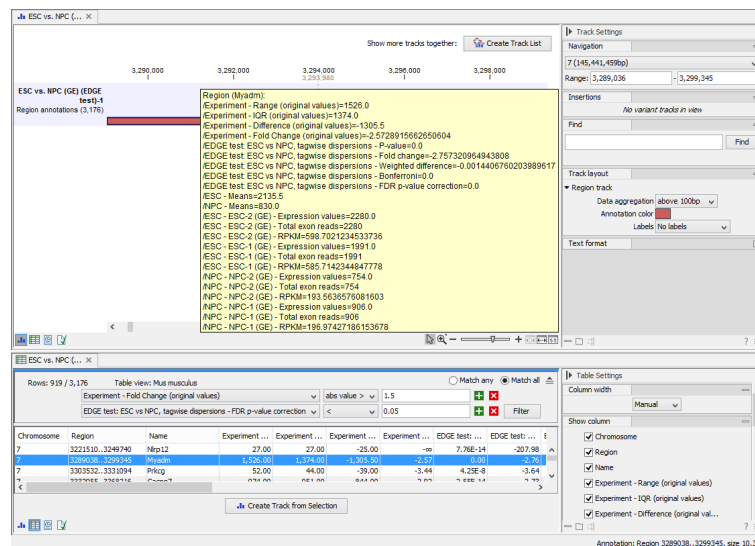



Figure 27.43: The annotations on the track produced by the Create Track from Experiment Tool

27.3.5 Visualizing RNA-Seq read tracks for the experiment

When working with RNA-Seq data, the experiment can be used to browse the read mappings to investigate how the reads supporting each sample are mapped. This is done by creating a track list:

File | New | Track List 

Select the mapping and expression tracks of the samples you wish to visualize together and select any annotation tracks (e.g. gene and mRNA) to be included for visualization **Finish**.

Once the track list is shown, create a split view or drag the tab of the view on to a second screen (if you have two screens). Clicking a row in the table makes the track list view jump to that location, allowing for quick inspection of interesting parts of the RNA-Seq read mapping (see an example in figure 27.44). Note that the **Zoom to selection**  button can be used to adjust the zoom level to fit the region selection.

Please note that at least one of the expression tracks used in the experiment have to be included in the track list in order for the link between the two to work.

27.4 Transformation and normalization

The original expression values often need to be transformed and/or normalized in order to ensure that samples are comparable and assumptions on the data for analysis are met [Allison et al., 2006]. These are essential requirements for carrying out a meaningful analysis. The raw expression values often exhibit a strong dependency of the variance on the mean, and it may be preferable to remove this by log-transforming the data. Furthermore, the sets of expression values in the different samples in an experiment may exhibit systematic differences that are likely due to differences in sample preparation and array processing, rather being the result of the underlying biology. These noise effects should be removed before statistical analysis is carried out.

When you perform transformation and normalization, the original expression values will be kept, and the new values will be added. If you select an experiment , the new values will be added

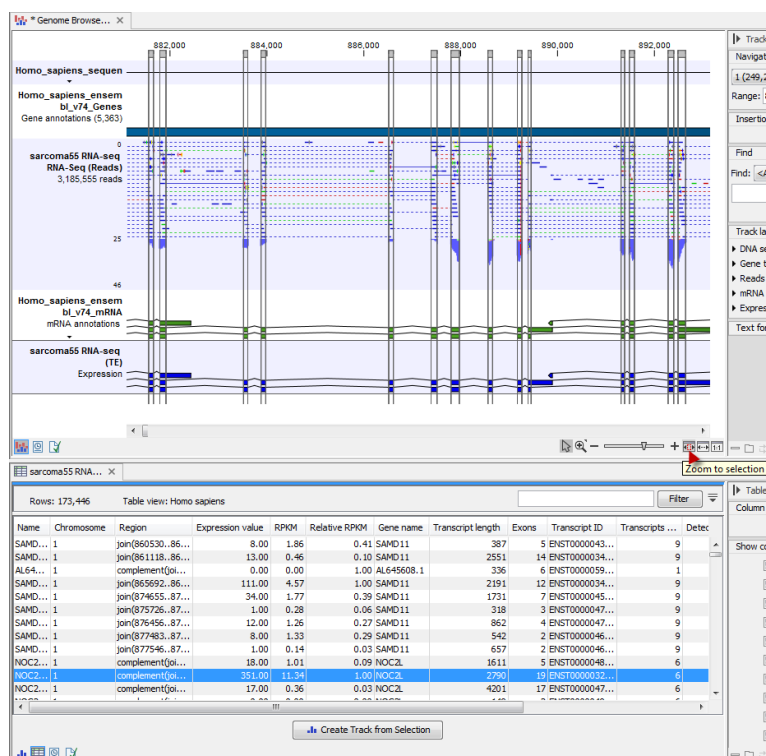



Figure 27.44: RNA-Seq results shown in a split view with an experiment table at the bottom and a track list with read mappings of several samples at the top.

to the experiment (not the original samples). And likewise if you select a sample ( or ) - in this case the new values will be added to the sample (the original values are still kept on the sample).

27.4.1 Selecting transformed and normalized values for analysis

A number of the tools for Expression Analysis use the following expression level values: *Original*, *Transformed* and *Normalized* (figure 27.45).

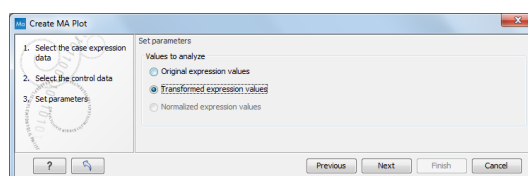

Figure 27.45: Selecting which version of the expression values to analyze. In this case, the values have not been normalized, so it is not possible to select normalized values.

In this case, the values have not been normalized, so it is not possible to select normalized values.

27.4.2 Transformation

The *CLC Genomics Workbench* lets you transform expression values based on logarithm and adding a constant:

Toolbox | Microarray and Small RNA Analysis () | Transformation and Normalization | Transform ()

Select a number of samples () or () or an experiment () and click **Next**.

This will display a dialog as shown in figure 27.46.

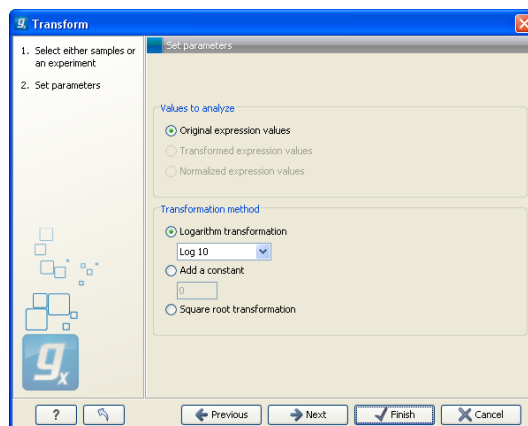

Figure 27.46: Transforming expression values.

At the top, you can select which values to transform (see section 27.4.1).

Next, you can choose three kinds of transformation:

- **Logarithm transformation.** Transformed expression values will be calculated by taking the logarithm (of the specified type) of the values you have chosen to transform.
 - **10.**
 - **2.**
 - **Natural logarithm.**
- **Adding a constant.** Transformed expression values will be calculated by adding the specified constant to the values you have chosen to transform.
- **Square root transformation.**

Click **Next** if you wish to adjust how to handle the results (see section 8.2). If not, click **Finish**.

27.4.3 Normalization

The *CLC Genomics Workbench* lets you normalize expression values.

To start the normalization:

Toolbox | Microarray and Small RNA Analysis () | Transformation and Normalization | Normalize ()

Select a number of samples () or () or an experiment () and click **Next**.

This will display a dialog as shown in figure 27.47.

At the top, you can choose three kinds of normalization (for mathematical descriptions see [Bolstad et al., 2003]):

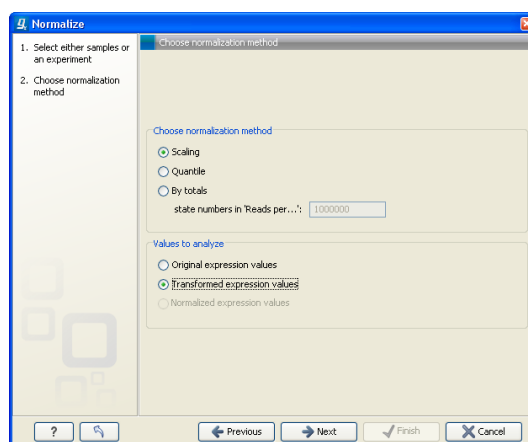

Figure 27.47: Choosing normalization method.

- **Scaling.** The sets of the expression values for the samples will be multiplied by a constant so that the sets of normalized values for the samples have the same 'target' value (see description of the **Normalization value** below).
- **Quantile.** The empirical distributions of the sets of expression values for the samples are used to calculate a common target distribution, which is used to calculate normalized sets of expression values for the samples.
- **By totals.** This option is intended to be used with count-based data, i.e. data from RNA-seq, small RNA or expression profiling by tags. A sum is calculated for the expression values in a sample. The transformed value are generated by dividing the input values by the sample sum and multiplying by the factor (e.g. per '1,000,000').

Figures 27.48 and 27.49 show the effect on the distribution of expression values when using scaling or quantile normalization, respectively.

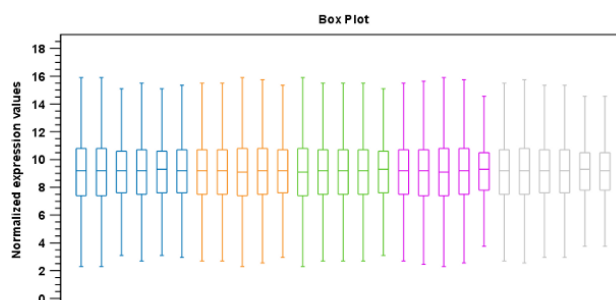

Figure 27.48: Box plot after scaling normalization.

At the bottom of the dialog in figure 27.47, you can select which values to normalize (see section 27.4.1).

Clicking **Next** will display a dialog as shown in figure 27.50.

The following parameters can be set:

- **Normalization value.** The type of value of the samples which you want to ensure are equal for the normalized expression values

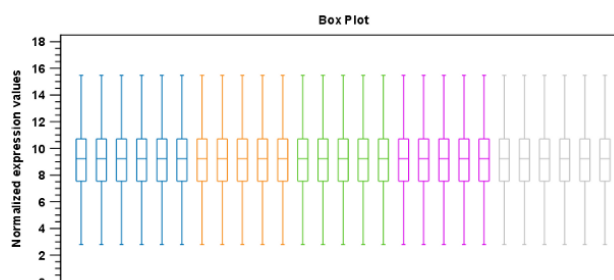

Figure 27.49: Box plot after quantile normalization.

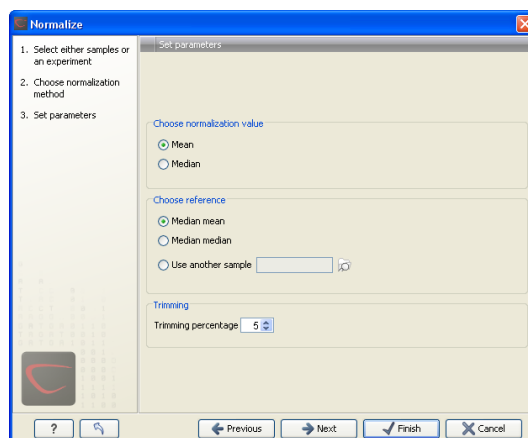

Figure 27.50: Normalization settings.

- **Mean.**
- **Median.**
- **Reference.** The specific value that you want the normalized value to be after normalization.
 - **Median mean.**
 - **Median median.**
 - **Use another sample.**
- **Trimming percentage.** Expression values that lie below the value of this percentile, or above 100 minus the value of this percentile, in the empirical distribution of the expression values in a sample will be excluded when calculating the normalization and reference values.

Click **Next** if you wish to adjust how to handle the results (see section 8.2). If not, click **Finish**.

27.5 Quality control

The *CLC Genomics Workbench* includes a number of tools for quality control. These allow visual inspection of the overall distributions, variability and similarity of the sets of expression values in samples, and may be used to spot unwanted systematic differences between samples, outlying samples and samples of poor quality, that you may want to exclude.

27.5.1 Creating box plots - analyzing distributions

In most cases you expect the majority of genes to behave similarly under the conditions considered, and only a smaller proportion to behave differently. Thus, at an overall level you would expect the distributions of the sets of expression values in samples in a study to be similar. A boxplot provides a visual presentation of the distributions of expression values in samples. For each sample the distribution of its values is presented by a line representing a center, a box representing the middle part, and whiskers representing the tails of the distribution. Differences in the overall distributions of the samples in a study may indicate that normalization is required before the samples are comparable. An atypical distribution for a single sample (or a few samples), relative to the remaining samples in a study, could be due to imperfections in the preparation and processing of the sample, and may lead you to reconsider using the sample(s).

To create a box plot:

Toolbox | Microarray and Small RNA Analysis () | Quality Control | Create Box Plot ()

Select a number of samples () or () or an experiment () and click **Next**.

This will display a dialog as shown in figure 27.51.

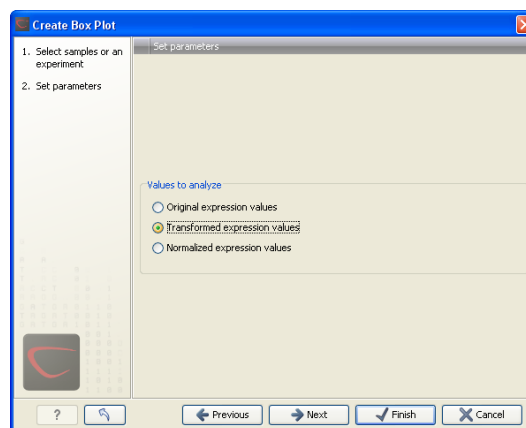

Figure 27.51: Choosing values to analyze for the box plot.

Here you select which values to use in the box plot (see section 27.4.1).

Click **Next** if you wish to adjust how to handle the results (see section 8.2). If not, click **Finish**.

Viewing box plots

An example of a box plot of a two-group experiment with 12 samples is shown in figure 27.52.

Note that the boxes per default are colored according to their group relationship. At the bottom you find the names of the samples, and the y-axis shows the expression values (note that sample names are not shown in figure 27.52).

Per default the box includes the IQR values (from the lower to the upper quartile), the median is displayed as a line in the box, and the whiskers extend 1.5 times the height of the box.

In the **Side Panel** to the left, there is a number of options to adjust this view. Under **Graph preferences**, you can adjust the general properties of the box plot (see figure 27.53).

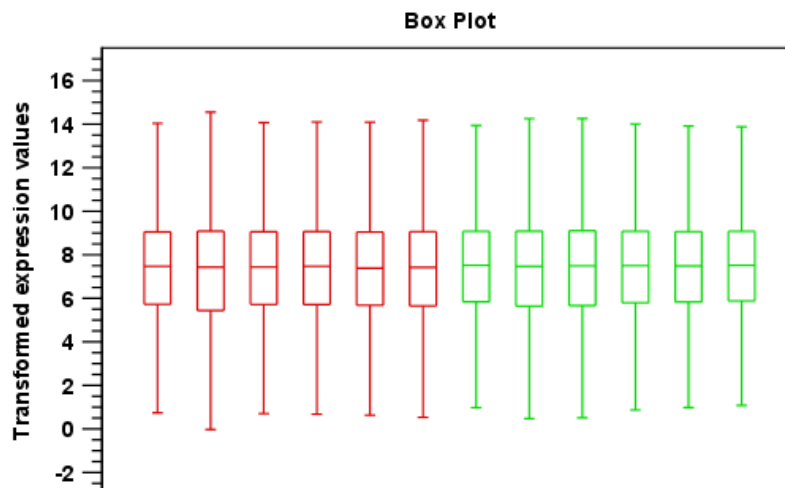

Figure 27.52: A box plot of 12 samples in a two-group experiment, colored by group.

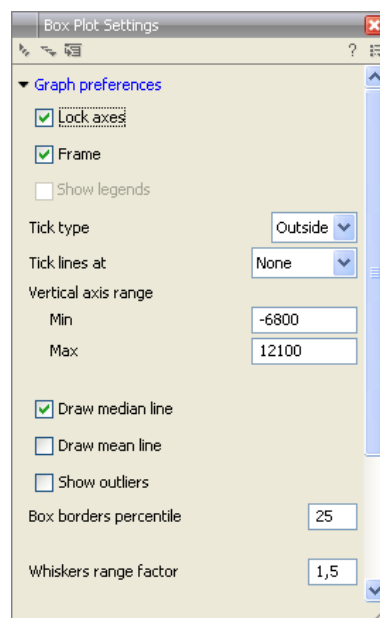

Figure 27.53: Graph preferences for a box plot.

- **Lock axes** This will always show the axes even though the plot is zoomed to a detailed level.
- **Frame** Shows a frame around the graph.
- **Show legends** Shows the data legends.
- **Tick type** Determine whether tick lines should be shown outside or inside the frame.
 - Outside
 - Inside
- **Tick lines at** Choosing Major ticks will show a grid behind the graph.
 - None

- Major ticks
- **Vertical axis range** Sets the range of the vertical axis (y axis). Enter a value in **Min** and **Max**, and press Enter. This will update the view. If you wait a few seconds without pressing Enter, the view will also be updated.
- **Draw median line.** This is the default - the median is drawn as a line in the box.
- **Draw mean line.** Alternatively, you can also display the mean value as a line.
- **Show outliers.** The values outside the whiskers range are called outliers. Per default they are not shown. Note that the dot type that can be set below only takes effect when outliers are shown. When you select and deselect the **Show outliers**, the vertical axis range is automatically re-calculated to accommodate the new values.

Below the general preferences, you find the **Lines and dots** preferences, where you can adjust coloring and appearance (see figure 27.54).

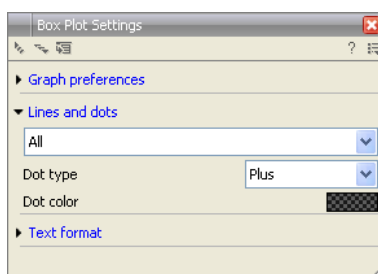

Figure 27.54: Lines and dot preferences for a box plot.

- **Select sample or group.** When you wish to adjust the properties below, first select an item in this drop-down menu. That will apply the changes below to this item. If your plot is based on an experiment, the drop-down menu includes both group names and sample names, as well as an entry for selecting "All". If your plot is based on single elements, only sample names will be visible. Note that there are sometimes "mixed states" when you select a group where two of the samples e.g. have different colors. Selecting a new color in this case will erase the differences.
- **Dot type**
 - None
 - Cross
 - Plus
 - Square
 - Diamond
 - Circle
 - Triangle
 - Reverse triangle
 - Dot

- **Dot color.** Allows you to choose between many different colors. Click the color box to select a color.

Note that if you wish to use the same settings next time you open a box plot, you need to save the settings of the **Side Panel** (see section 4.6).

Interpreting the box plot

This section will show how to interpret a box plot through a few examples.

First, if you look at figure 27.55, you can see a box plot for an experiment with 5 groups and 27 samples.

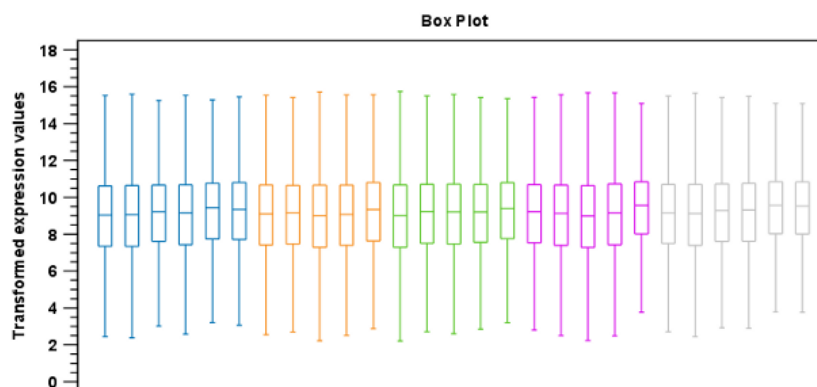

Figure 27.55: Box plot for an experiment with 5 groups and 27 samples.

None of the samples stand out as having distributions that are atypical: the boxes and whiskers ranges are about equally sized. The locations of the distributions however, differ some, and indicate that normalization may be required. Figure 27.56 shows a box plot for the same experiment after quantile normalization: the distributions have been brought into par.

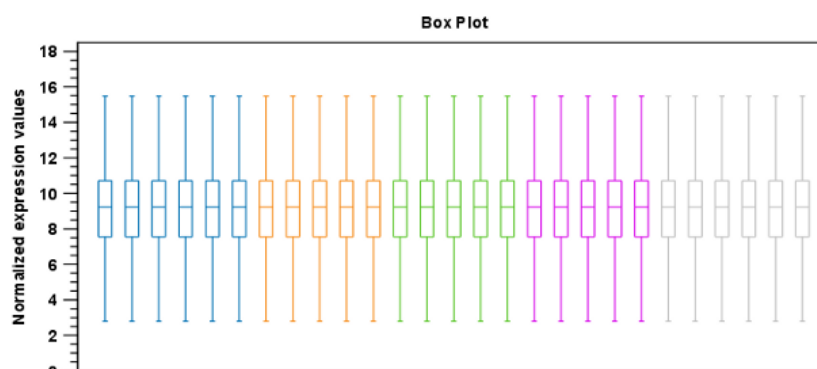

Figure 27.56: Box plot after quantile normalization.

In figure 27.57 a box plot for a two group experiment with 5 samples in each group is shown.

The distribution of values in the second sample from the left is quite different from those of other samples, and could indicate that the sample should not be used.

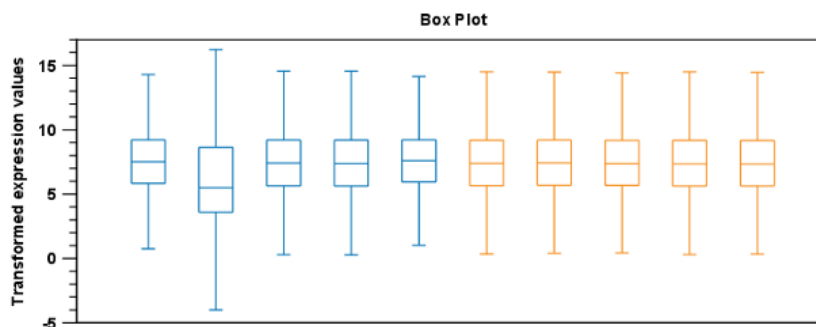

Figure 27.57: Box plot for a two-group experiment with 5 samples.

27.5.2 Hierarchical clustering of samples

A hierarchical clustering of samples is a tree representation of their relative similarity.

The tree structure is generated by

1. letting each sample be a cluster
2. calculating pairwise distances between all clusters
3. joining the two closest clusters into one new cluster
4. iterating 2-3 until there is only one cluster left (which will contain all samples).

The tree is drawn so that the distances between clusters are reflected by the lengths of the branches in the tree. Thus, features with expression profiles that closely resemble each other have short distances between them, those that are more different, are placed further apart.

(See [Eisen et al., 1998] for a classical example of application of a hierarchical clustering algorithm in microarray analysis. The example is on features rather than samples).

To start the clustering:

Toolbox | Microarray and Small RNA Analysis (🇺🇸) | Quality Control | Hierarchical Clustering of Samples (🇺🇸)

Select a number of samples (🇺🇸) or (🇺🇸) or an experiment (🇺🇸) and click **Next**.

This will display a dialog as shown in figure 27.58. The hierarchical clustering algorithm requires that you specify a distance measure and a cluster linkage. The similarity measure is used to specify how distances between two samples should be calculated. The cluster distance metric specifies how you want the distance between two clusters, each consisting of a number of samples, to be calculated.

At the top, you can choose three kinds of **Distance measures**:

- **Euclidean distance.** The ordinary distance between two points - the length of the segment connecting them. If $u = (u_1, u_2, \dots, u_n)$ and $v = (v_1, v_2, \dots, v_n)$, then the Euclidean distance between u and v is

$$|u - v| = \sqrt{\sum_{i=1}^n (u_i - v_i)^2}.$$

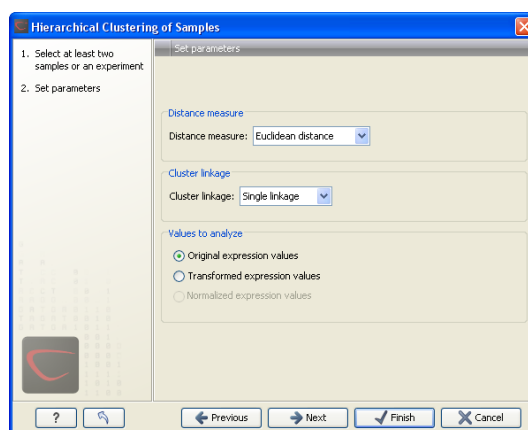

Figure 27.58: Parameters for hierarchical clustering of samples.

- **1 - Pearson correlation.** The Pearson correlation coefficient between two elements $x = (x_1, x_2, \dots, x_n)$ and $y = (y_1, y_2, \dots, y_n)$ is defined as

$$r = \frac{1}{n-1} \sum_{i=1}^n \left(\frac{x_i - \bar{x}}{s_x} \right) * \left(\frac{y_i - \bar{y}}{s_y} \right)$$

where \bar{x}/\bar{y} is the average of values in x/y and s_x/s_y is the sample standard deviation of these values. It takes a value $\in [-1, 1]$. Highly correlated elements have a high absolute value of the Pearson correlation, and elements whose values are un-informative about each other have Pearson correlation 0. Using $1 - |\text{Pearson correlation}|$ as distance measure means that elements that are highly correlated will have a short distance between them, and elements that have low correlation will be more distant from each other.

- **Manhattan distance.** The Manhattan distance between two points is the distance measured along axes at right angles. If $u = (u_1, u_2, \dots, u_n)$ and $v = (v_1, v_2, \dots, v_n)$, then the Manhattan distance between u and v is

$$|u - v| = \sum_{i=1}^n |u_i - v_i|.$$

Next, you can select the cluster linkage to be used:

- **Single linkage.** The distance between two clusters is computed as the distance between the two closest elements in the two clusters.
- **Average linkage.** The distance between two clusters is computed as the average distance between objects from the first cluster and objects from the second cluster. The averaging is performed over all pairs (x, y) , where x is an object from the first cluster and y is an object from the second cluster.
- **Complete linkage.** The distance between two clusters is computed as the maximal object-to-object distance $d(x_i, y_j)$, where x_i comes from the first cluster, and y_j comes from the second cluster. In other words, the distance between two clusters is computed as the distance between the two farthest objects in the two clusters.

At the bottom, you can select which values to cluster (see section 27.4.1).

Click **Next** if you wish to adjust how to handle the results (see section 8.2). If not, click **Finish**.

Note: To be run on a server, the tool has to be included in a workflow, and the results will be displayed in a stand alone new heat map rather than added into the input experiment table.

Result of hierarchical clustering of samples

The result of a sample clustering is shown in figure 27.59.

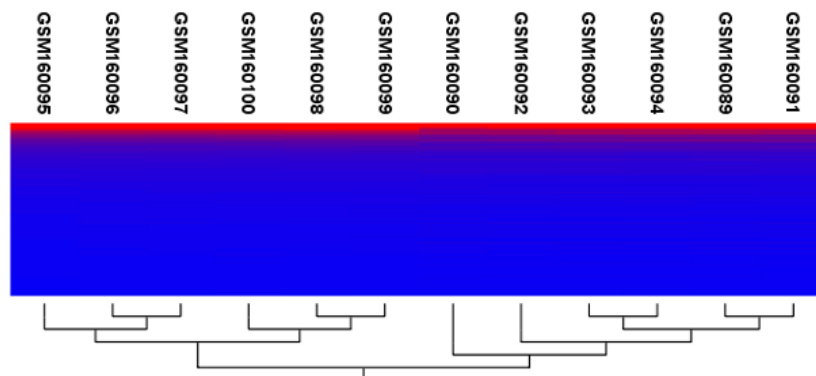

Figure 27.59: Sample clustering.

If you have used an **experiment** (📊) and ran the non-workflow version of the tool, the clustering is added to the experiment and will be saved when you save the experiment. It can be viewed by clicking the **Show Heat Map** (📊) button at the bottom of the view (see figure 27.60).



Figure 27.60: Showing the hierarchical clustering of an experiment.

If you have run the workflow version of the tool, or selected a number of **samples** (📊) or (🇺🇸) as input, a new element will be created that has to be saved separately.

Regardless of the input, the view of the clustering is the same. As you can see in figure 27.59, there is a tree at the bottom of the view to visualize the clustering. The names of the samples are listed at the top. The features are represented as horizontal lines, colored according to the expression level. If you place the mouse on one of the lines, you will see the names of the feature to the left. The features are sorted by their expression level in the first sample (in order to cluster the features, see section 27.7.1).

Researchers often have a priori knowledge of which samples in a study should be similar (e.g. samples from the same experimental condition) and which should be different (samples from biological distinct conditions). Thus, researchers have expectations about how they should cluster. Samples that are placed unexpectedly in the hierarchical clustering tree may be samples that have been wrongly allocated to a group, samples of unintended or unclear tissue composition or samples for which the processing has gone wrong. Unexpectedly placed samples, of course, could also be highly interesting samples.

There are a number of options to change the appearance of the heat map. At the top of the **Side Panel**, you find the **Heat map** preference group (see figure 27.61).

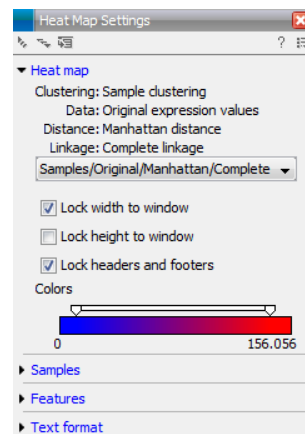

Figure 27.61: Side Panel of heat map.

At the top, there is information about the heat map currently displayed. The information regards type of clustering, expression value used together with distance and linkage information. If you have performed more than one clustering, you can choose between the resulting heat maps in a drop-down box (see figure 27.75).

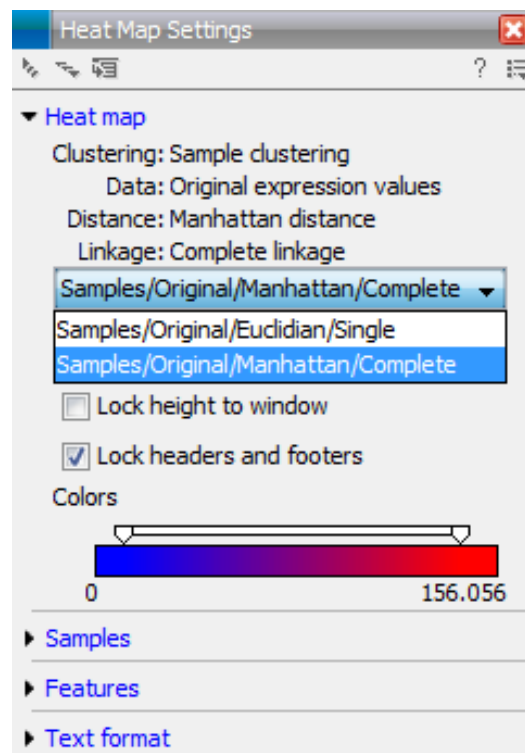

Figure 27.62: When more than one clustering has been performed, there will be a list of heat maps to choose from.

Note that if you perform an identical clustering, the existing heat map will simply be replaced. Below this box, there is a number of settings for displaying the heat map.

- **Lock width to window.** When you zoom in the heat map, you will per default only zoom in on the vertical level. This is because the width of the heat map is locked to the window. If you uncheck this option, you will zoom both vertically and horizontally. Since you always

have more features than samples, it is useful to lock the width since you then have all the samples in view all the time.

- **Lock height to window.** This is the corresponding option for the height. Note that if you check both options, you will not be able to zoom at all, since both the width and the height is fixed.
- **Lock headers and footers.** This will ensure that you are always able to see the sample and feature names and the trees when you zoom in.
- **Colors.** The expression levels are visualized using a gradient color scheme, where the right side color is used for high expression levels and the left side color is used for low expression levels. You can change the coloring by clicking the box, and you can change the relative coloring of the values by dragging the two knobs on the white slider above.

Below you find the **Samples** and **Features** groups. They contain options to show names, legend, and tree above or below the heatmap. Note that for clustering of samples, you find the tree options in the **Samples** group, and for clustering of features, you find the tree options in the **Features** group. With the tree options, you can also control the **Tree size**, from tiny to very large, and the option of showing the full tree, no matter how much space it will use.

Note that if you wish to use the same settings next time you open a heat map, you need to save the settings of the **Side Panel** (see section 4.6).

27.5.3 Principal component analysis

A principal component analysis is a mathematical analysis that identifies and quantifies the directions of variability in the data. For a set of samples, e.g. an experiment, this can be done either by finding the eigenvectors and eigenvalues of the *covariance matrix* of the samples or the *correlation matrix* of the samples (the correlation matrix is a 'normalized' version of the covariance matrix: the entries in the covariance matrix look like this $Cov(X, Y)$, and those in the correlation matrix like this: $Cov(X, Y)/(sd(X) * sd(Y))$). A covariance maybe any value, but a correlation is always between -1 and 1).

The eigenvectors are orthogonal. The first principal component is the eigenvector with the largest eigenvalue, and specifies the direction with the largest variability in the data. The second principal component is the eigenvector with the second largest eigenvalue, and specifies the direction with the second largest variability. Similarly for the third, etc. The data can be projected onto the space spanned by the eigenvectors. A plot of the data in the space spanned by the first and second principal component will show a simplified version of the data with variability in other directions than the two major directions of variability ignored.

To start the analysis:

Toolbox | Microarray and Small RNA Analysis  | **Quality Control | Principal Component Analysis** 

Select a number of samples ( or ) or an experiment () and click **Next**.

This will display a dialog as shown in figure 27.63.

In this dialog, you select the values to be used for the principal component analysis (see section 27.4.1).

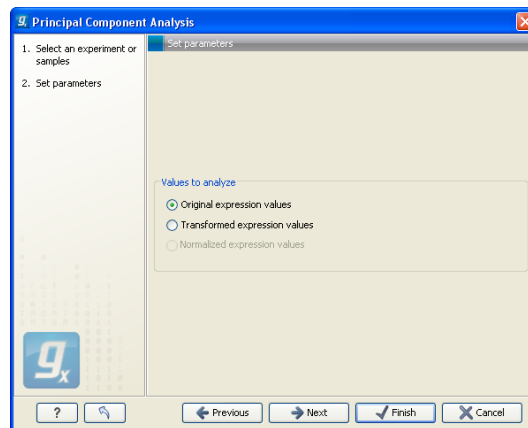

Figure 27.63: Selecting which values the principal component analysis should be based on.

Click **Next** if you wish to adjust how to handle the results (see section 8.2). If not, click **Finish**.

Principal component analysis plot

This will create a principal component plot as shown in figure 27.64.

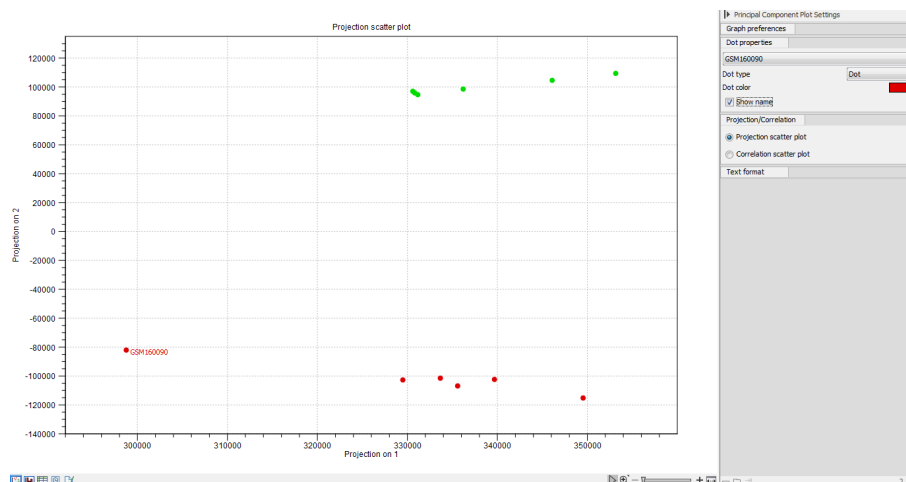

Figure 27.64: A principal component analysis colored by group.

The plot shows the projection of the samples onto the two-dimensional space spanned by the first and second principal component of the covariance matrix. In the bottom part of the side-panel, the 'Projection/Correlation' part, you can change to show the projection onto the *correlation* matrix rather than the *covariance* matrix by choosing 'Correlation scatter plot'. Both plots will show how the samples separate along the two directions between which the samples exhibit the largest amount of variation. For the 'projection scatter plot' this variation is measured in absolute terms, and depends on the units in which you have measured your samples. The correlation scatter plot is a normalized version of the projection scatter plot, which makes it possible to compare principal component analysis between experiments, even when these have not been done using the same units (e.g an experiment that uses 'original' scale data and another one that uses 'log-scale' data).

The plot in figure 27.64 is based on a two-group experiment. The group relationships are indicated by color. We expect the samples from within a group to exhibit less variability when compared,

than samples from different groups. Thus samples should cluster according to groups and this is what we see. The PCA plot is thus helpful in identifying outlying samples and samples that have been wrongly assigned to a group.

In the **Side Panel** to the left, there is a number of options to adjust the view. Under **Graph preferences**, you can adjust the general properties of the plot.

- **Lock axes** This will always show the axes even though the plot is zoomed to a detailed level.
- **Frame** Shows a frame around the graph.
- **Show legends** Shows the data legends.
- **Tick type** Determine whether tick lines should be shown outside or inside the frame.
 - Outside
 - Inside
- **Tick lines at** Choosing Major ticks will show a grid behind the graph.
 - None
 - Major ticks
- **Horizontal axis range** Sets the range of the horizontal axis (x axis). Enter a value in **Min** and **Max**, and press Enter. This will update the view. If you wait a few seconds without pressing Enter, the view will also be updated.
- **Vertical axis range** Sets the range of the vertical axis (y axis). Enter a value in **Min** and **Max**, and press Enter. This will update the view. If you wait a few seconds without pressing Enter, the view will also be updated.
- **y = 0 axis**. Draws a line where $y = 0$. Below there are some options to control the appearance of the line:
 - **Line width**
 - * Thin
 - * Medium
 - * Wide
 - **Line type**
 - * None
 - * Line
 - * Long dash
 - * Short dash
 - **Line color**. Allows you to choose between many different colors. Click the color box to select a color.

Below the general preferences, you find the **Dot properties**:

- **Drop down menu** In this you choose which of the samples (that is, which 'dots') the choices you make below should apply to. You can choose between 'All', a particular group in your experiment, or a particular samples in your experiment.
- **Select sample or group.** When you wish to adjust the properties below, first select an item in this drop-down menu. That will apply the changes below to this item. If your plot is based on an experiment, the drop-down menu includes both group names and sample names, as well as an entry for selecting "All". If your plot is based on single elements, only sample names will be visible. Note that there are sometimes "mixed states" when you select a group where two of the samples e.g. have different colors. Selecting a new color in this case will erase the differences.
- **Dot type**
 - None
 - Cross
 - Plus
 - Square
 - Diamond
 - Circle
 - Triangle
 - Reverse triangle
 - Dot
- **Dot color.** Allows you to choose between many different colors. Click the color box to select a color.
- **Show name.** This will show a label with the name of the sample next to the dot. Note that the labels quickly get crowded, so that is why the names are not put on per default.

Note that if you wish to use the same settings next time you open a principal component plot, you need to save the settings of the **Side Panel** (see section 4.6).

Scree plot

Besides the view shown in figure 27.64, the result of the principal component can also be viewed as a scree plot by clicking the **Show Scree Plot** () button at the bottom of the view. The scree plot shows the proportion of variation in the data explained by each of the principal components. The first principal component accounts for the largest part of the variability.

In the **Side Panel** to the left, there is a number of options to adjust the view. Under **Graph preferences**, you can adjust the general properties of the plot.

- **Lock axes** This will always show the axes even though the plot is zoomed to a detailed level.
- **Frame** Shows a frame around the graph.
- **Show legends** Shows the data legends.

- **Tick type** Determine whether tick lines should be shown outside or inside the frame.
 - Outside
 - Inside
- **Tick lines at** Choosing Major ticks will show a grid behind the graph.
 - None
 - Major ticks
- **Horizontal axis range** Sets the range of the horizontal axis (x axis). Enter a value in **Min** and **Max**, and press Enter. This will update the view. If you wait a few seconds without pressing Enter, the view will also be updated.
- **Vertical axis range** Sets the range of the vertical axis (y axis). Enter a value in **Min** and **Max**, and press Enter. This will update the view. If you wait a few seconds without pressing Enter, the view will also be updated.

The **Lines and plots** below contains the following parameters:

- **Dot type**
 - None
 - Cross
 - Plus
 - Square
 - Diamond
 - Circle
 - Triangle
 - Reverse triangle
 - Dot
- **Dot color.** Allows you to choose between many different colors. Click the color box to select a color.
- **Line width**
 - Thin
 - Medium
 - Wide
- **Line type**
 - None
 - Line
 - Long dash
 - Short dash

- **Line color.** Allows you to choose between many different colors. Click the color box to select a color.

Note that the graph title and the axes titles can be edited simply by clicking them with the mouse. These changes will be saved when you **Save** () the graph - whereas the changes in the **Side Panel** need to be saved explicitly (see section 4.6).

27.6 Statistical analysis - identifying differential expression

The *CLC Genomics Workbench* is designed to help you identify differential expression. You have a choice of a number of standard statistical tests, that are suitable for different data types and different types of experimental settings. There are two main types of tests: tests that assume that data consists of counts and compare these or their proportions (described in section 27.6.1 and section 27.6.2) and tests that assume that the data is real-valued, has Gaussian distributions and compare means (described in section 27.6.3).

To run the statistical analysis:

Toolbox | Microarray and Small RNA Analysis () | **Statistical Analysis | Empirical Analysis of DGE** ()

Toolbox | Microarray and Small RNA Analysis () | **Statistical Analysis | Proportion-based Statistical Analysis** ()

or **Toolbox | Microarray and Small RNA Analysis** () | **Statistical Analysis | Gaussian Statistical Analysis** ()

For all kinds of statistical analyses, you first select the experiment () that you wish to use and click **Next** (learn more about setting up experiments in section 27.2.1).

The first part of the explanation of how to proceed and perform the statistical analysis is divided into three, depending on whether you are doing Empirical analysis of DGE, tests on proportions or Gaussian-based tests. The last part has an explanation of the options regarding corrected p-values which applies to all tests.

27.6.1 Empirical analysis of DGE

The Empirical analysis of DGE tool implements the 'Exact Test' for two-group comparisons developed by Robinson and Smyth [Robinson and Smyth, 2008] and incorporated in the EdgeR Bioconductor package [Robinson et al., 2010]. The test is applicable to count data only, and is designed specifically to deal with situations in which *many* features are studied simultaneously (e.g. genes in a genome) but where only a *few* biological replicates are available for each of the experimental groups studied. This is typically the case for RNA-seq expression analysis.

The test uses the raw counts, and implicitly carries out normalization and transformation of these counts (see below for details). It is based on the assumption that the count data follows a Negative Binomial distribution, which in contrast to the Poisson distribution has the characteristic that it allows for a non-constant mean-variance relationship. The test is also appropriate for larger numbers of samples.

The 'Exact Test' of Robinson and Smyth is similar to Fisher's Exact Test, but also accounts for overdispersion caused by biological variability. Whereas Fisher's Exact Test compares the counts

in one sample against those of another, the 'Exact Test' compares the counts in one set of count samples against those in another set of count samples. This is achieved by replacing the Hypergeometric distributions of Fisher's Exact Test by Negative binomial distributions, whereby the variability within each of the two groups of samples compared is taken into account. This only works if the dispersions in the two groups compared are identical. As this cannot generally be assumed to be the case for the *original* (nor for the normalized) data, pseudodata for which the dispersion is identical is generated from the original data, and the test is carried out on this pseudodata. The generation of the pseudodata is performed simultaneously with the estimation of the dispersion, in an iterative procedure called quantile-adjusted conditional maximum likelihood. Either a single common dispersion for all features may be assumed (as in [Robinson and Smyth, 2008]), or it may be assumed that the dispersion for each feature (e.g. gene) is a 'weighted average' of the common dispersion and feature (e.g. gene) specific dispersions (as suggested in [Robinson and Smyth, 2007]). The weight given to each of the components depends on the number of samples in the groups: the more samples there are in the groups, the higher the weight will be given to the gene-specific component.

The Exact Test in the EdgeR Bioconductor package provides the user with the option to set a large number of parameters. The implementation of the 'Empirical analysis of DGE' algorithm in the Genomics Workbench uses for the most parts the default settings in the edgeR package, version 3.4.0. A detailed outline of the parameter settings is given in section 27.6.1).

Empirical analysis of DGE - implementation parameters

The 'Empirical analysis of DGE' algorithm in the *CLC Genomics Workbench* is a re-implementation of the "Exact Test", available as part of the EdgeR Bioconductor package.

The parameter values used in the *CLC Genomics Workbench* implementation are the default values for the equivalent parameters in the EdgeR Bioconductor implementation in all but one case. The exception is the `estimateCommonDisp tol` parameter, where the default is more stringent than that of EdgeR. The advantage of using a more stringent value for this parameter is that the results will be more accurate. The disadvantage is that the algorithm will be slightly slower, however according to our performance tests, this change has only a marginal impact on the run time of the tool.

The parameter values used in the *CLC Genomics Workbench* implementation, with reference to the EdgeR function names for clarity, are provided in the table below.

Function in BioC package	Parameter name	Value used and comments
calcNormFactors	method	"TMM"
	refColumn	NULL (automatically selected)
	logratioTrim	0.3
	sumTrim	0.05
	doWeighting	TRUE
	Acutoff	-1e10
estimateCommonDisp	tol	1e-14 (default in edgeR: 1e-6)
	rowsum.filter	Set by user in wizard ("Total count filter cutoff", default 5)
estimateTagewiseDisp	prior.df	10
	trend	"movingave"
	span	NULL
	method	"grid"
	grid.length	11
	grid.range	c(-6, 6)
mglimOneGroup	maxit	50
	tol	1e-10
aveLogCPM	prior.count	2
	dispersion	0.05
exactTest	pair	Set by user in wizard ("Exact test comparisons")
	dispersion	"auto" (tagwise if available, otherwise common)
	rejection.region	"doubletail"
	big.count	900
	prior.count	0.125

Running the Empirical analysis of DGE

First, find the **Empirical analysis of DGE** tool:

Toolbox | Microarray and Small RNA Analysis (📁) | Statistical Analysis | Empirical Analysis of DGE (📄)

The original count data for a full expression experiment are the expected input to the Empirical Analysis of DGE tool.

When Experiments created within the Workbench are used as input, the original count values are always used. Columns of such Experiments that contain transformed or normalized values are ignored.

If expression values are being imported from outside the Workbench for use with this test, the data should be original (non-transformed, non-normalized) counts.

Whether the data has been generated in the Workbench or outside the Workbench and imported, the full set of expression results should be used. Please do not run this test on a subset of values from the original sample data.

The reason that the complete set of original count data for samples should be used as input to this test is that the algorithm assumes that the counts on which it operates are Negative Binomially distributed. It implicitly normalizes and transforms these counts, so if the counts have been altered prior to submitting them to the Empirical Analysis of DGE tool, this assumption is

likely to be compromised.

When running the Empirical analysis of DGE tool in the Genomics workbench, the user is asked to specify two parameters related to the estimation of the dispersion (figure 27.65). Of these, the 'Total count filter cut-off' specifies which features should be considered when estimating the common dispersion component. Features for which the counts across all samples are low are likely to contribute mostly with noise to the estimation, and features with a lower cumulative count across samples than the value specified will be ignored. When the check-box 'Estimate tag-wise dispersions' is checked, the dispersion estimate for each gene will be a weighted combination of the tag-wise and common dispersion, if the check-box is un-ticked the common dispersion will be used for all genes.

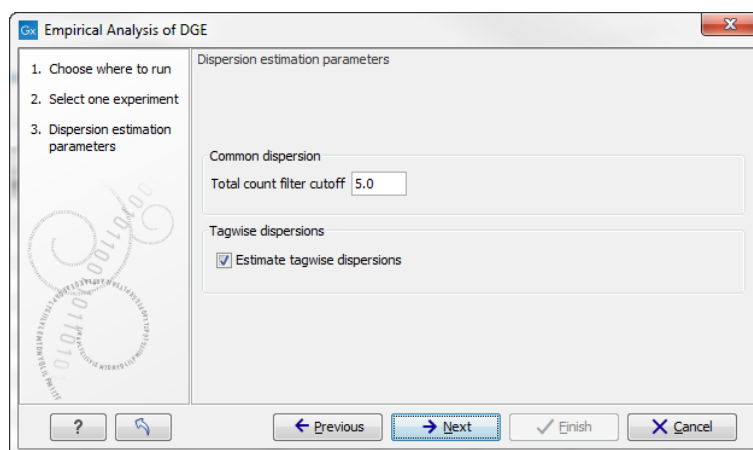

Figure 27.65: Empirical analysis of DGE: setting the parameters related to dispersion.

The Empirical analysis of DGE may be carried out between all pairs of groups (by clicking the 'All pairs' button) or for each group against a specified reference group (by clicking the 'Against reference' button) (figure 27.66). In the last case you must specify which of the groups you want to use as reference (the default is to use the group you specified as Group 1 when you set up the experiment). For example, the All pairs option should be selected when you wish to perform the test of equality for group means for all of the pairs, e.g. if you would like to compare different tissues where each tissue is represented in a group. In this case there is no reference group, so the following comparisons will be performed:

- liver vs heart
- liver vs lung
- heart vs lung

The Against reference option should be selected when you wish to perform the test of equality for group means against one group, the reference, rather than all groups as above. Against reference could be used if you have a wild type and some mutant groups, e.g. Wild type, Mutant 1 and Mutant 2. In this case you might be interested in comparing the mutants to the wild type, but comparing the mutants to each other is not of interest. In this case the Wild Type group is considered the reference and the comparisons will be performed:

- Wild type vs Mutant 1

- Wild type vs Mutant 2

Note that with the Against reference option fewer comparisons are made, as in the above example where Mutant 1 vs. Mutant 2 is not considered.

The user can specify if Bonferroni and FDR corrected p-values should be calculated (see Section 27.6.4).

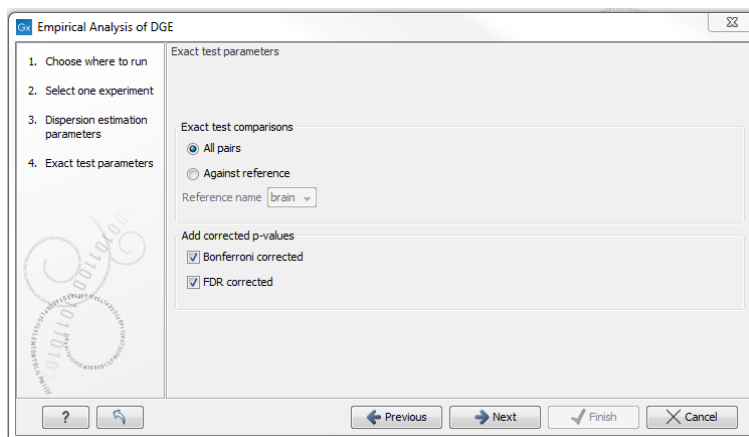

Figure 27.66: Empirical analysis of DGE: setting comparisons and corrected p-value options.

When the Empirical analysis of DGE is run three columns will be added to the experiment table for each pair of groups that are analyzed: the 'P-value', 'Fold change' and 'Weighted difference' columns. The 'P-value' holds the p-value for the Exact test. The 'Fold Change' and 'Weighted difference' columns are both calculated from the estimated relative abundances, which are derived internally in the Exact Test algorithm. They depend on both the sizes (depth of coverage/library size) of the samples, the magnitude of the counts and on the estimated negative binomial dispersion, so they cannot be obtained from the original counts by simple algebraic calculations.

The 'Fold Change' will tell you how many times bigger the relative abundance of group 2 is relative to that of group 1. If the relative abundance of group 2 is bigger than that of group 1 the fold change is the relative abundance of group 2 divided by that of group 1. If the relative abundance of group 2 is smaller than that of group 1 the fold change is the relative abundance of group 1 divided by that of group 2 with a negative sign. The 'weighted difference' column contains the difference between the relative abundance of group 2 and the relative abundance of group 1. In addition to the three automatically added columns, columns containing the Bonferroni and FDR corrected p-values will be added if that was specified by the user.

27.6.2 Tests on proportions

The proportions-based tests are applicable in situations where your data samples consists of counts of a number of 'types' of data. This could e.g. be in a study where gene expression levels are measured by RNA-Seq or tag profiling. Here the different 'types' could correspond to the different 'genes' in a reference genome, and the counts could be the numbers of reads matching each of these genes. The tests compare counts by considering the proportions that they make up the total sum of counts in each sample. By comparing the expression levels at the level of proportions rather than raw counts, the data is corrected for sample size.

There are two tests available for comparing proportions: the test of [Kal et al., 1999] and the test of [Baggerly et al., 2003]. Both tests compare pairs of groups. If you have a multi-group experiment (see section 27.2.1), you may choose either to have tests produced for all pairs of groups (by clicking the 'All pairs' button) or to have a test produced for each group compared to a specified reference group (by clicking the 'Against reference' button). In the last case you must specify which of the groups you want to use as reference (the default is to use the group you specified as Group 1 when you set up the experiment).

Note that the proportion-based tests use the total sample counts (that is, the sum over all expression values). If one (or more) of the counts are NaN, the sum will be NaN and all the test statistics will be NaN. As a consequence all p-values will also be NaN. You can avoid this by filtering your experiment and creating a new experiment so that no NaN values are present, before you apply the tests.

Kal et al.'s test (Z-test)

Kal et al.'s test [Kal et al., 1999] compares a single sample against another single sample, and thus requires that each group in your experiment has only one sample. The test relies on an approximation of the binomial distribution by the normal distribution [Kal et al., 1999]. Considering proportions rather than raw counts the test is also suitable in situations where the sum of counts is different between the samples.

When Kal's test is run on an experiment four columns will be added to the experiment table for each pair of groups that are analyzed. The 'Proportions difference' column contains the difference between the proportion in group 2 and the proportion in group 1. The 'Fold Change' column tells you how many times bigger the proportion in group 2 is relative to that of group 1. If the proportion in group 2 is bigger than that in group 1 this value is the proportion in group 2 divided by that in group 1. If the proportion in group 2 is smaller than that in group 1 the fold change is the proportion in group 1 divided by that in group 2 with a negative sign. The 'Test statistic' column holds that value of the test statistic, and the 'P-value' holds the two-sided p-value for the test. Up to two more columns may be added if the options to calculate Bonferroni and FDR corrected p-values were chosen (see 27.6.4).

Baggerly et al.'s test (Beta-binomial)

Baggerly et al.'s test [Baggerly et al., 2003] compares the proportions of counts in a group of samples against those of another group of samples, and is suited to cases where replicates are available in the groups. The samples are given different weights depending on their sizes (total counts). The weights are obtained by assuming a Beta distribution on the proportions in a group, and estimating these, along with the proportion of a binomial distribution, by the method of moments. The result is a weighted t-type test statistic.

When Baggerly's test is run on an experiment four columns will be added to the experiment table for each pair of groups that are analyzed. The 'Weighted proportions difference' column contains the difference between the mean of the weighted proportions across the samples assigned to group 2 and the mean of the weighted proportions across the samples assigned to group 1. The 'Weighted proportions fold change' column tells you how many times bigger the mean of the weighted proportions in group 2 is relative to that of group 1. If the mean of the weighted proportions in group 2 is bigger than that in group 1 this value is the mean of the weighted proportions in group 2 divided by that in group 1. If the mean of the weighted proportions in

group 2 is smaller than that in group 1 the fold change is the mean of the weighted proportions in group 1 divided by that in group 2 with a negative sign. The 'Test statistic' column holds that value of the test statistic, and the 'P-value' holds the two-sided p-value for the test. Up to two more columns may be added if the options to calculate Bonferroni and FDR corrected p-values were chosen (see 27.6.4).

27.6.3 Gaussian-based tests

The tests based on the Gaussian distribution essentially compare the mean expression level in the experimental groups in the study, and evaluates the significance of the difference relative to the variance (or 'spread') of the data within the groups. The details of the formula used for calculating the test statistics vary according to the experimental setup and the assumptions you make about the data (read more about this in the sections on t-test and ANOVA below). The explanation of how to proceed is divided into two, depending on how many groups there are in your experiment. First comes the explanation for t-tests which is the only analysis available for two-group experimental setups (t-tests can also be used for pairwise comparison of groups in multi-group experiments). Next comes an explanation of the ANOVA test which can be used for multi-group experiments.

Note that the test statistics for the t-test and ANOVA analysis use the estimated group variances in their denominators. If all expression values in a group are identical the estimated variance for that group will be zero. If the estimated variances for both (or all) groups are zero the denominator of the test statistic will be zero. The numerator's value depends on the difference of the group means. If this is zero, the numerator is zero and the test statistic will be 0/0 which is NaN. If the numerator is different from zero the test statistic will be + or - infinity, depending on which group mean is bigger. If all values in all groups are identical the test statistic is set to zero.

T-tests

For experiments with two groups you can, among the Gaussian tests, only choose a **T-test** as shown in figure 27.67.

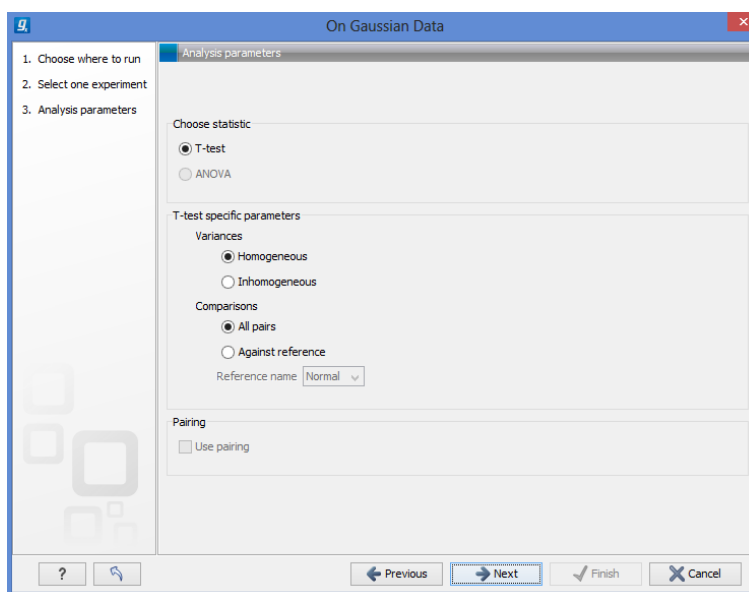

Figure 27.67: Selecting a t-test.

There are different types of t-tests, depending on the assumption you make about the variances in the groups. By selecting 'Homogeneous' (the default) calculations are done assuming that the groups have equal variances. When 'In-homogeneous' is selected, this assumption is not made.

The t-test can also be chosen if you have a multi-group experiment. In this case you may choose either to have t-tests produced for all pairs of groups (by clicking the 'All pairs' button) or to have a t-test produced for each group compared to a specified reference group (by clicking the 'Against reference' button). In the last case you must specify which of the groups you want to use as reference (the default is to use the group you specified as Group 1 when you set up the experiment).

If a experiment with pairing was set up (see section 27.2.1) the **Use pairing** tick box is active. If ticked, paired t-tests will be calculated, if not, the formula for the standard t-test will be used.

When a t-test is run on an experiment four columns will be added to the experiment table for each pair of groups that are analyzed. The 'Difference' column contains the difference between the mean of the expression values across the samples assigned to group 2 and the mean of the expression values across the samples assigned to group 1. The 'Fold Change' column tells you how many times bigger the mean expression value in group 2 is relative to that of group 1. If the mean expression value in group 2 is bigger than that in group 1 this value is the mean expression value in group 2 divided by that in group 1. If the mean expression value in group 2 is smaller than that in group 1 the fold change is the mean expression value in group 1 divided by that in group 2 with a negative sign. The 'Test statistic' column holds that value of the test statistic, and the 'P-value' holds the two-sided p-value for the test. Up to two more columns may be added if the options to calculate Bonferroni and FDR corrected p-values were chosen (see 27.6.4).

ANOVA

For experiments with more than two groups you can choose **T-test** as described above, or **ANOVA** as shown in figure 27.68.

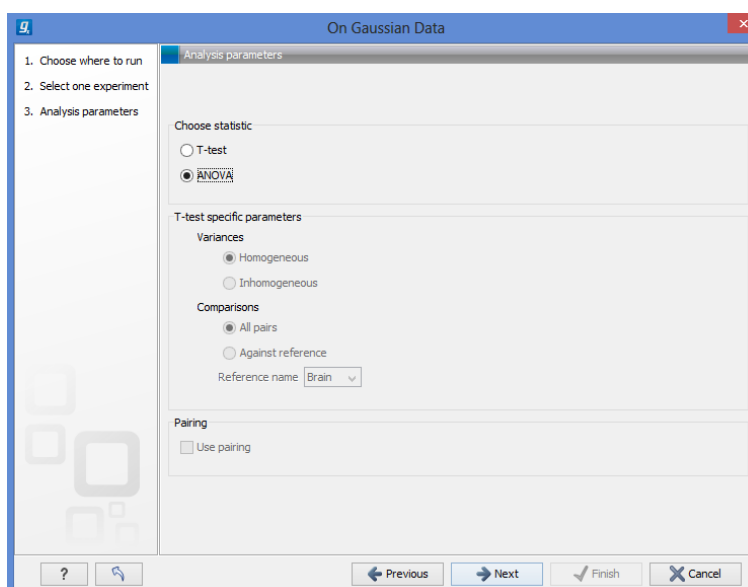

Figure 27.68: Selecting ANOVA.

The ANOVA method allows analysis of an experiment with one factor and a number of groups,

e.g. different types of tissues, or time points. In the analysis, the variance within groups is compared to the variance between groups. You get a significant result (that is, a small ANOVA p-value) if the difference you see between groups relative to that within groups, is larger than what you would expect, if the data were really drawn from groups with equal means.

If an experiment with pairing was set up (see section 27.2.1) the **Use pairing** tick box is active. If ticked, a repeated measures one-way ANOVA test will be calculated, if not, the formula for the standard one-way ANOVA will be used.

When an ANOVA analysis is run on an experiment four columns will be added to the experiment table for each pair of groups that are analyzed. The 'Max difference' column contains the difference between the maximum and minimum of the mean expression values of the groups, multiplied by -1 if the group with the maximum mean expression value occurs before the group with the minimum mean expression value (with the ordering: group 1, group 2, ...). The 'Max fold change' column contains the ratio of the maximum of the mean expression values of the groups to the minimum of the mean expression values of the groups, multiplied by -1 if the group with the maximum mean expression value occurs before the group with the minimum mean expression value (with the ordering: group 1, group 2, ...). The 'Test statistic' column holds the value of the test statistic, and the 'P-value' holds the two-sided p-value for the test. Up to two more columns may be added if the options to calculate Bonferroni and FDR corrected p-values were chosen (see 27.6.4).

27.6.4 Corrected p-values

Clicking **Next** will display a dialog as shown in figure 27.69.

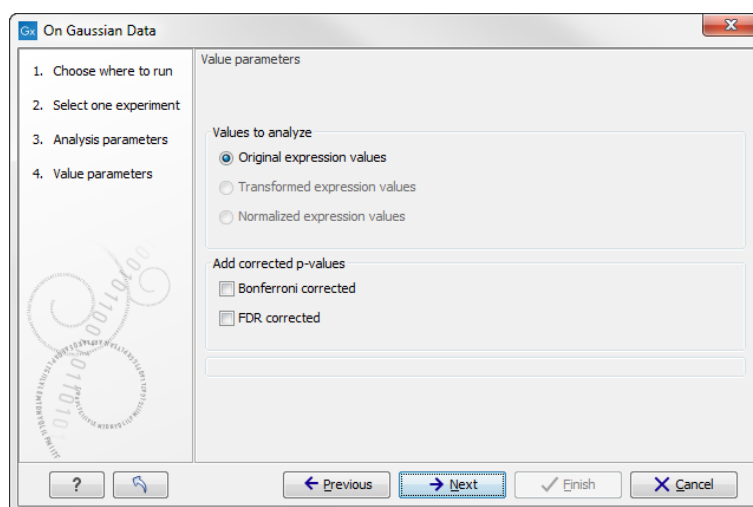

Figure 27.69: Additional settings for the statistical analysis.

At the top, you can select which values to analyze (see section 27.4.1).

Below you can select to add two kinds of corrected p-values to the analysis (in addition to the standard p-value produced for the test statistic):

- **Bonferroni corrected.**
- **FDR corrected.**

Both are calculated from the original p-values, and aim in different ways to take into account the issue of multiple testing [Dudoit et al., 2003]. The problem of multiple testing arises because the original p-values are related to a single test: the p-value is the probability of observing a more extreme value than that observed in the test carried out. If the p-value is 0.04, we would expect an as extreme value as that observed in 4 out of 100 tests carried out among groups with no difference in means. Popularly speaking, if we carry out 10000 tests and select the features with original p-values below 0.05, we will expect about 0.05 times 10000 = 500 to be false positives.

The Bonferroni corrected p-values handle the multiple testing problem by controlling the 'family-wise error rate': the probability of making at least one false positive call. They are calculated by multiplying the original p-values by the number of tests performed. The probability of having at least one false positive among the set of features with Bonferroni corrected p-values below 0.05, is less than 5%. The Bonferroni correction is conservative: there may be many genes that are differentially expressed among the genes with Bonferroni corrected p-values above 0.05, that will be missed if this correction is applied.

Instead of controlling the family-wise error rate we can control the false discovery rate: FDR. The false discovery rate is the proportion of false positives among all those declared positive. We expect 5 % of the features with FDR corrected p-values below 0.05 to be false positive. There are many methods for controlling the FDR - the method used in *CLC Genomics Workbench* is that of [Benjamini and Hochberg, 1995].

Click **Next** if you wish to adjust how to handle the results (see section 8.2). If not, click **Finish**.

Note that if you have already performed statistical analysis on the same values, the existing one will be overwritten.

27.6.5 Volcano plots - inspecting the result of the statistical analysis

The results of the statistical analysis are added to the experiment and can be shown in the experiment table (see section 27.2.2). Typically columns containing the differences (or weighted differences) of the mean group values and the fold changes (or weighted fold changes) of the mean group values will be added along with a column of p-values. Also, columns with FDR or Bonferroni corrected p-values will be added if these were calculated. This added information allows features to be sorted and filtered to exclude the ones without sufficient proof of differential expression (learn more in section 3.3).

If you want a more visual approach to the results of the statistical analysis, you can click the **Show Volcano Plot**  button at the bottom of the experiment table view. In the same way as the scatter plot presented in section 27.2.4, the volcano plot is yet another view on the experiment. Because it uses the p-values and mean differences produced by the statistical analysis, the plot is only available once a statistical analysis has been performed on the experiment.

An example of a volcano plot is shown in figure 27.70.

The volcano plot shows the relationship between the p-values of a statistical test and the magnitude of the difference in expression values of the samples in the groups. On the y-axis the $-\log_{10}$ p-values are plotted. For the x-axis you may choose between two sets of values by choosing either 'Fold change' or 'Difference' in the volcano plot side panel's 'Values' part. If you choose 'Fold change' the log of the values in the 'fold change' (or 'Weighted fold change') column for the test will be displayed. If you choose 'Difference' the values in the 'Difference' (or 'Weighted difference') column will be used. Which values you wish to display will depend upon

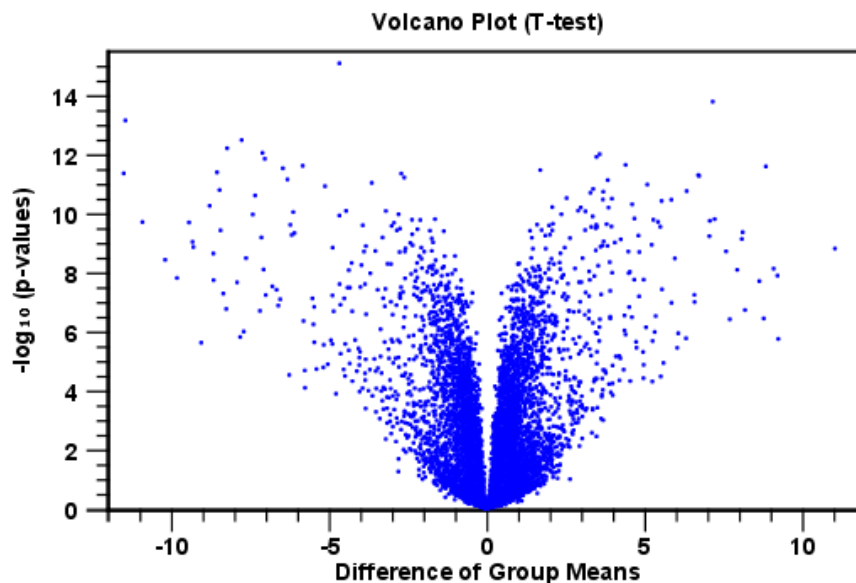

Figure 27.70: Volcano plot.

the scale of your data (Read the note on fold change in section [27.2.2](#)).

The larger the difference in expression of a feature, the more extreme its point will lie on the X-axis. The more significant the difference, the smaller the p-value and thus the higher the $-\log_{10}(p)$ value. Thus, points for features with highly significant differences will lie high in the plot. Features of interest are typically those which change significantly and by a certain magnitude. These are the points in the upper left and upper right hand parts of the volcano plot.

If you have performed different tests or you have an experiment with multiple groups you need to specify for which test and which group comparison you want the volcano plot to be shown. You do this in the 'Test' and 'Values' parts of the volcano plot side panel.

Options for the volcano plot are described in further detail when describing the **Side Panel** below.

If you place your mouse on one of the dots, a small text box will tell the name of the feature. Note that you can zoom in and out on the plot (see section [2.2](#)).

In the **Side Panel** to the right, there is a number of options to adjust the view of the volcano plot. Under **Graph preferences**, you can adjust the general properties of the volcano plot

- **Lock axes** This will always show the axes even though the plot is zoomed to a detailed level.
- **Frame** Shows a frame around the graph.
- **Show legends** Shows the data legends.
- **Tick type** Determine whether tick lines should be shown outside or inside the frame.
 - Outside
 - Inside

- **Tick lines at** Choosing Major ticks will show a grid behind the graph.
 - None
 - Major ticks
- **Horizontal axis range** Sets the range of the horizontal axis (x axis). Enter a value in **Min** and **Max**, and press Enter. This will update the view. If you wait a few seconds without pressing Enter, the view will also be updated.
- **Vertical axis range** Sets the range of the vertical axis (y axis). Enter a value in **Min** and **Max**, and press Enter. This will update the view. If you wait a few seconds without pressing Enter, the view will also be updated.

Below the general preferences, you find the **Dot properties**, where you can adjust coloring and appearance of the dots.

- **Dot type**
 - None
 - Cross
 - Plus
 - Square
 - Diamond
 - Circle
 - Triangle
 - Reverse triangle
 - Dot
- **Dot color.** Allows you to choose between many different colors. Click the color box to select a color.

At the very bottom, you find two groups for choosing which values to display:

- **Test.** In this group, you can select which kind of test you want the volcano plot to be shown for.
- **Values.** Under **Values**, you can select which values to plot. If you have multi-group experiments, you can select which groups to compare. You can also select whether to plot **Difference** or **Fold change** on the x-axis. Read the note on fold change in section [27.2.2](#).

Note that if you wish to use the same settings next time you open a box plot, you need to save the settings of the **Side Panel** (see section [4.6](#)).

27.7 Feature clustering

Feature clustering is used to identify and cluster together features with similar expression patterns over samples (or experimental groups). Features that cluster together may be involved in the same biological process or be co-regulated. Also, by examining annotations of genes within a cluster, one may learn about the underlying biological processes involved in the experiment studied.

27.7.1 Hierarchical clustering of features

A hierarchical clustering of features is a tree presentation of the similarity in expression profiles of the features over a set of samples (or groups).

The tree structure is generated by

1. letting each feature be a cluster
2. calculating pairwise distances between all clusters
3. joining the two closest clusters into one new cluster
4. iterating 2-3 until there is only one cluster left (which will contain all samples).

The tree is drawn so that the distances between clusters are reflected by the lengths of the branches in the tree. Thus, features with expression profiles that closely resemble each other have short distances between them, those that are more different, are placed further apart.

To start the clustering of features:

Toolbox | Microarray and Small RNA Analysis (📁) | Feature Clustering | Hierarchical Clustering of Features (🔧)

Select at least two samples (📊) or (🇺🇸🇬🇧) or an experiment (📋).

Note! If your data contains many features, the clustering will take very long time and could make your computer unresponsive. It is recommended to perform this analysis on a subset of the data (which also makes it easier to make sense of the clustering. Typically, you will want to filter away the features that are thought to represent only noise, e.g. those with mostly low values, or with little difference between the samples). See how to create a sub-experiment in section 27.2.2.

Clicking **Next** will display a dialog as shown in figure 27.71. The hierarchical clustering algorithm requires that you specify a distance measure and a cluster linkage. The distance measure is used specify how distances between two features should be calculated. The cluster linkage specifies how you want the distance between two clusters, each consisting of a number of features, to be calculated.

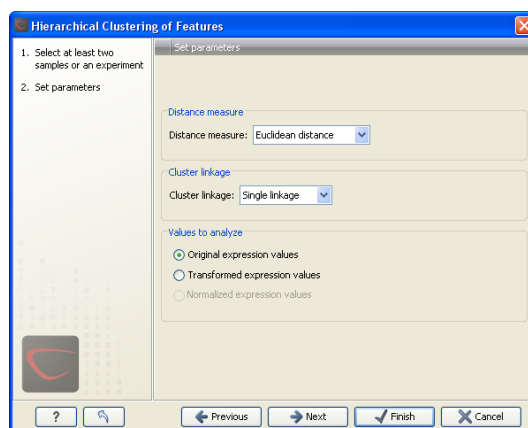

Figure 27.71: Parameters for hierarchical clustering of features.

At the top, you can choose three kinds of **Distance measures**:

- **Euclidean distance.** The ordinary distance between two points - the length of the segment connecting them. If $u = (u_1, u_2, \dots, u_n)$ and $v = (v_1, v_2, \dots, v_n)$, then the Euclidean distance between u and v is

$$|u - v| = \sqrt{\sum_{i=1}^n (u_i - v_i)^2}.$$

- **1 - Pearson correlation.** The Pearson correlation coefficient between two elements $x = (x_1, x_2, \dots, x_n)$ and $y = (y_1, y_2, \dots, y_n)$ is defined as

$$r = \frac{1}{n-1} \sum_{i=1}^n \left(\frac{x_i - \bar{x}}{s_x} \right) * \left(\frac{y_i - \bar{y}}{s_y} \right)$$

where \bar{x}/\bar{y} is the average of values in x/y and s_x/s_y is the sample standard deviation of these values. It takes a value $\in [-1, 1]$. Highly correlated elements have a high absolute value of the Pearson correlation, and elements whose values are un-informative about each other have Pearson correlation 0. Using $1 - |Pearsoncorrelation|$ as distance measure means that elements that are highly correlated will have a short distance between them, and elements that have low correlation will be more distant from each other.

- **Manhattan distance.** The Manhattan distance between two points is the distance measured along axes at right angles. If $u = (u_1, u_2, \dots, u_n)$ and $v = (v_1, v_2, \dots, v_n)$, then the Manhattan distance between u and v is

$$|u - v| = \sum_{i=1}^n |u_i - v_i|.$$

Next, you can select different ways to calculate distances between clusters. The possible cluster linkage to use are:

- **Single linkage.** The distance between two clusters is computed as the distance between the two closest elements in the two clusters.
- **Average linkage.** The distance between two clusters is computed as the average distance between objects from the first cluster and objects from the second cluster. The averaging is performed over all pairs (x, y) , where x is an object from the first cluster and y is an object from the second cluster.
- **Complete linkage.** The distance between two clusters is computed as the maximal object-to-object distance $d(x_i, y_j)$, where x_i comes from the first cluster, and y_j comes from the second cluster. In other words, the distance between two clusters is computed as the distance between the two farthest objects in the two clusters.

At the bottom, you can select which values to cluster (see section 27.4.1). Click **Next** if you wish to adjust how to handle the results (see section 8.2). If not, click **Finish**.

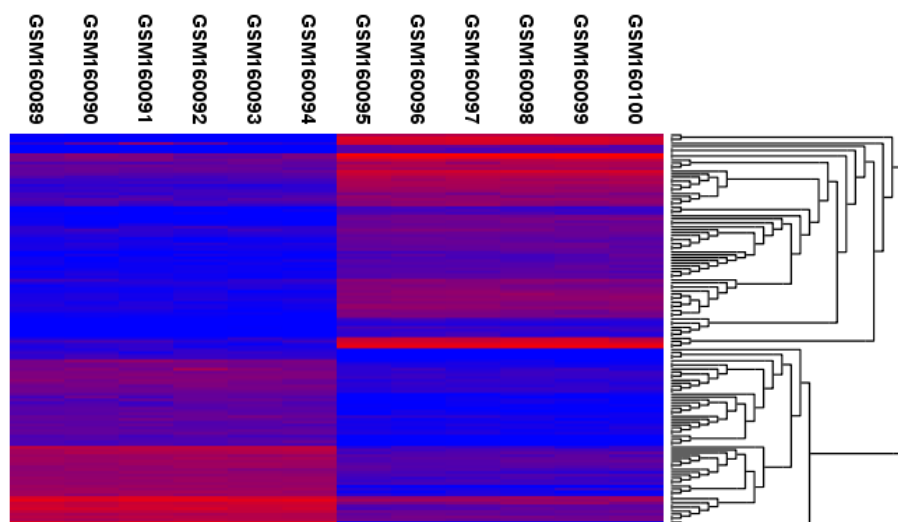

Figure 27.72: Hierarchical clustering of features.



Figure 27.73: Showing the hierarchical clustering of an experiment.

Result of hierarchical clustering of features

The result of a feature clustering is shown in figure 27.72.

If you have used an **experiment** (📊) as input, the clustering is added to the experiment and will be saved when you save the experiment. It can be viewed by clicking the **Show Heat Map** (🔥) button at the bottom of the view (see figure 27.73).

If you have selected a number of **samples** (🌍) or (🇺🇸) as input, a new element will be created that has to be saved separately.

Regardless of the input, a hierarchical tree view with associated heatmap is produced (figure 27.72). In the heatmap each row corresponds to a feature and each column to a sample. The color in the i 'th row and j 'th column reflects the expression level of feature i in sample j (the color scale can be set in the side panel). The order of the rows in the heatmap are determined by the hierarchical clustering. If you place the mouse on one of the rows, you will see the name of the corresponding feature to the left. The order of the columns (that is, samples) is determined by their input order or (if defined) experimental grouping. The names of the samples are listed at the top of the heatmap and the samples are organized into groups.

There are a number of options to change the appearance of the heat map. At the top of the **Side Panel**, you find the **Heat map** preference group (see figure 27.74).

At the top, there is information about the heat map currently displayed. The information regards type of clustering, expression value used together with distance and linkage information. If you have performed more than one clustering, you can choose between the resulting heat maps in a drop-down box (see figure 27.75).

Note that if you perform an identical clustering, the existing heat map will simply be replaced.

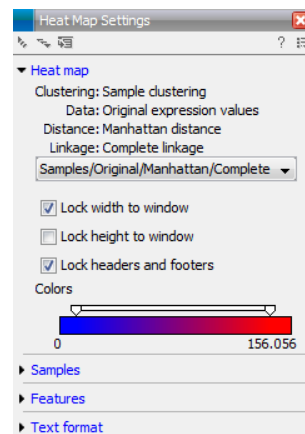

Figure 27.74: Side Panel of heat map.

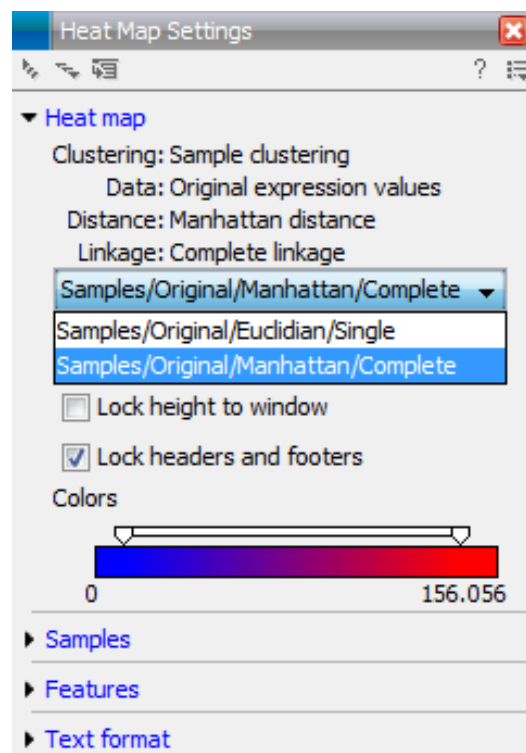

Figure 27.75: When more than one clustering has been performed, there will be a list of heat maps to choose from.

Below this box, there is a number of settings for displaying the heat map.

- **Lock width to window.** When you zoom in the heat map, you will per default only zoom in on the vertical level. This is because the width of the heat map is locked to the window. If you uncheck this option, you will zoom both vertically and horizontally. Since you always have more features than samples, it is useful to lock the width since you then have all the samples in view all the time.
- **Lock height to window.** This is the corresponding option for the height. Note that if you check both options, you will not be able to zoom at all, since both the width and the height is fixed.

- **Lock headers and footers.** This will ensure that you are always able to see the sample and feature names and the trees when you zoom in.
- **Colors.** The expression levels are visualized using a gradient color scheme, where the right side color is used for high expression levels and the left side color is used for low expression levels. You can change the coloring by clicking the box, and you can change the relative coloring of the values by dragging the two knobs on the white slider above.

Below you find the **Samples** and **Features** groups. They contain options to show names, legend, and tree above or below the heatmap. Note that for clustering of samples, you find the tree options in the **Samples** group, and for clustering of features, you find the tree options in the **Features** group. With the tree options, you can also control the **Tree size**, from tiny to very large, and the option of showing the full tree, no matter how much space it will use.

Note that if you wish to use the same settings next time you open a heat map, you need to save the settings of the **Side Panel** (see section 4.6).

27.7.2 K-means/medoids clustering

In a k-means or medoids clustering, features are clustered into k separate clusters. The procedures seek to find an assignment of features to clusters, for which the distances between features within the cluster is small, while distances between clusters are large.

Toolbox | Microarray and Small RNA Analysis (📊) | Feature Clustering | K-means/medoids Clustering (🔍)

Select at least two samples (🇩🇪 or 🇺🇸) or an experiment (📊).

Note! If your data contains many features, the clustering will take very long time and could make your computer unresponsive. It is recommended to perform this analysis on a subset of the data (which also makes it easier to make sense of the clustering). See how to create a sub-experiment in section 27.2.2.

Clicking **Next** will display a dialog as shown in figure 27.76.

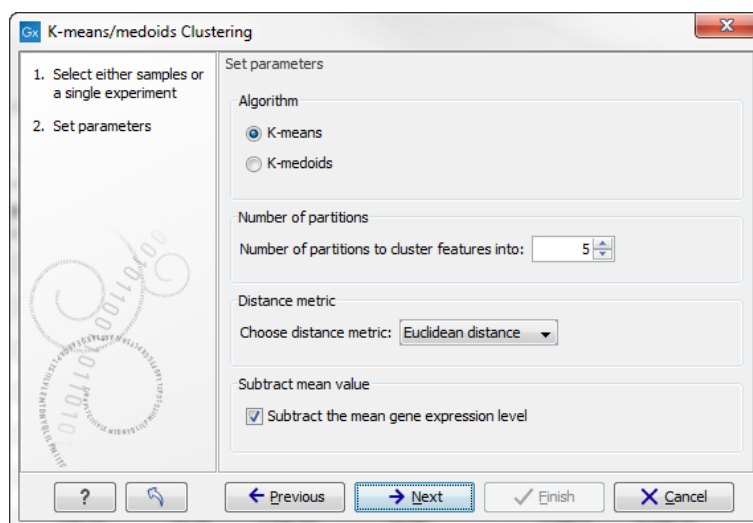

Figure 27.76: Parameters for k-means/medoids clustering.

The parameters are:

- **Algorithm.** You can choose between two clustering methods:

- **K-means.** K-means clustering assigns each point to the cluster whose center is nearest. The center/centroid of a cluster is defined as the average of all points in the cluster. If a data set has three dimensions and the cluster has two points $X = (x_1, x_2, x_3)$ and $Y = (y_1, y_2, y_3)$, then the centroid Z becomes $Z = (z_1, z_2, z_3)$, where $z_i = (x_i + y_i)/2$ for $i = 1, 2, 3$. The algorithm attempts to minimize the intra-cluster variance defined by:

$$V = \sum_{i=1}^k \sum_{x_j \in S_i} (x_j - \mu_i)^2$$

where there are k clusters $S_i, i = 1, 2, \dots, k$ and μ_i is the centroid of all points $x_j \in S_i$. The detailed algorithm can be found in [Lloyd, 1982].

- **K-medoids.** K-medoids clustering is computed using the PAM-algorithm (PAM is short for Partitioning Around Medoids). It chooses datapoints as centers in contrast to the K-means algorithm. The PAM-algorithm is based on the search for k representatives (called medoids) among all elements of the dataset. When having found k representatives k clusters are now generated by assigning each element to its nearest medoid. The algorithm first looks for a good initial set of medoids (the BUILD phase). Then it finds a local minimum for the objective function:

$$V = \sum_{i=1}^k \sum_{x_j \in S_i} (x_j - c_i)^2$$

where there are k clusters $S_i, i = 1, 2, \dots, k$ and c_i is the medoid of S_i . This solution implies that there is no single switch of an object with a medoid that will decrease the objective (this is called the SWAP phase). The PAM-algorithm is described in [Kaufman and Rousseeuw, 1990].

- **Number of partitions.** The number of partitions to cluster features into.
- **Distance metric.** The metric to compute distance between data points.
 - **Euclidean distance.** The ordinary distance between two elements - the length of the segment connecting them. If $u = (u_1, u_2, \dots, u_n)$ and $v = (v_1, v_2, \dots, v_n)$, then the Euclidean distance between u and v is

$$|u - v| = \sqrt{\sum_{i=1}^n (u_i - v_i)^2}.$$

- **Manhattan distance.** The Manhattan distance between two elements is the distance measured along axes at right angles. If $u = (u_1, u_2, \dots, u_n)$ and $v = (v_1, v_2, \dots, v_n)$, then the Manhattan distance between u and v is

$$|u - v| = \sum_{i=1}^n |u_i - v_i|.$$

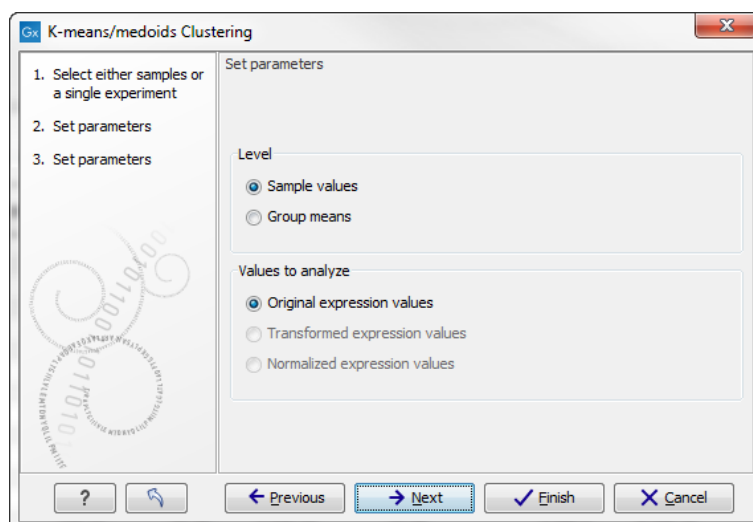

Figure 27.77: Parameters for *k*-means/medoids clustering.

- **Subtract mean value.** For each gene, subtract the mean gene expression value over all input samples.

Clicking **Next** will display a dialog as shown in figure 27.77.

At the top, you can choose the **Level** to use. Choosing 'sample values' means that distances will be calculated using all the individual values of the samples. When 'group means' are chosen, distances are calculated using the group means.

At the bottom, you can select which values to cluster (see section 27.4.1).

Click **Next** if you wish to adjust how to handle the results (see section 8.2). If not, click **Finish**.

Viewing the result of *k*-means/medoids clustering

The result of the clustering is a number of graphs. The number depends on the number of partitions chosen (figure 27.76) - there is one graph per cluster. Using drag and drop as explained in section 2.1.7, you can arrange the views to see more than one graph at the time.

Figure 27.78 shows an example where four clusters have been arranged side-by-side.

The samples used are from a time-series experiment, and you can see that the expression levels for each cluster have a distinct pattern. The two clusters at the bottom have falling and rising expression levels, respectively, and the two clusters at the top both fall at the beginning but then rise again (the one to the right starts to rise earlier than the other one).

Having inspected the graphs, you may wish to take a closer look at the features represented in each cluster. In the experiment table, the clustering has added an extra column with the name of the cluster that the feature belongs to. In this way you can filter the table to see only features from a specific cluster. This also means that you can select the feature of this cluster in a volcano or scatter plot as described in section 27.2.5.

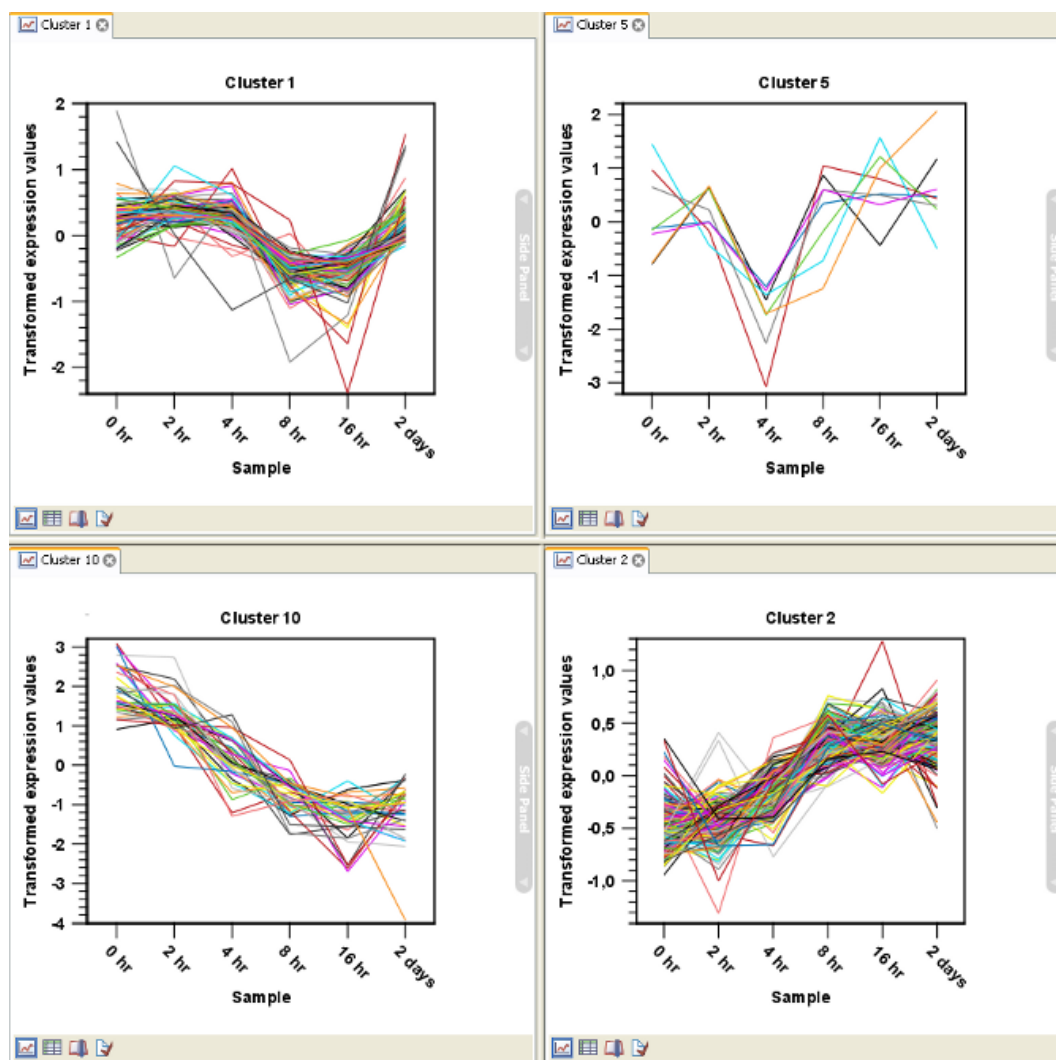

Figure 27.78: Four clusters created by k-means/medoids clustering.

27.8 Annotation tests

The annotation tests are tools for detecting significant patterns among features (e.g. genes) of experiments, based on their annotations. This may help in interpreting the analysis of the large numbers of features in an experiment in a biological context. Which biological context, depends on which annotation you choose to examine, and could e.g. be biological process, molecular function or pathway as specified by the Gene Ontology or KEGG. The annotation testing tools of course require that the features in the experiment you want to analyze are annotated. Learn how to annotate an experiment in section [27.2.3](#).

27.8.1 Hypergeometric tests on annotations

The first approach to using annotations to extract biological information is the hypergeometric annotation test. This test measures the extent to which the annotation categories of features in a smaller gene list, 'A', are over or under-represented relative to those of the features in larger gene list 'B', of which 'A' is a sub-list. Gene list B is often the features of the full experiment, possibly with features which are thought to represent only noise, filtered away. Gene list A is a sub-experiment of the full experiment where most features have been filtered away and only those

that seem of interest are kept. Typically gene list A will consist of a list of candidate differentially expressed genes. This could be the gene list obtained after carrying out a statistical analysis on the experiment, and choosing to keep only those features with FDR corrected p-values <0.05 and a fold change larger than 2 in absolute value. The hypergeometric test procedure implemented is similar to the unconditional GOSTATS test of [Falcon and Gentleman, 2007].

Toolbox | Microarray and Small RNA Analysis (📁) | Annotation Test | Hypergeometric Tests on Annotations (🌐)

This will show a dialog where you can select the two experiments - the larger experiment, e.g. the original experiment including the full list of features - and a sub-experiment (see how to create a sub-experiment in section 27.2.2).

Click **Next**. This will display the dialog shown in figure 27.79.

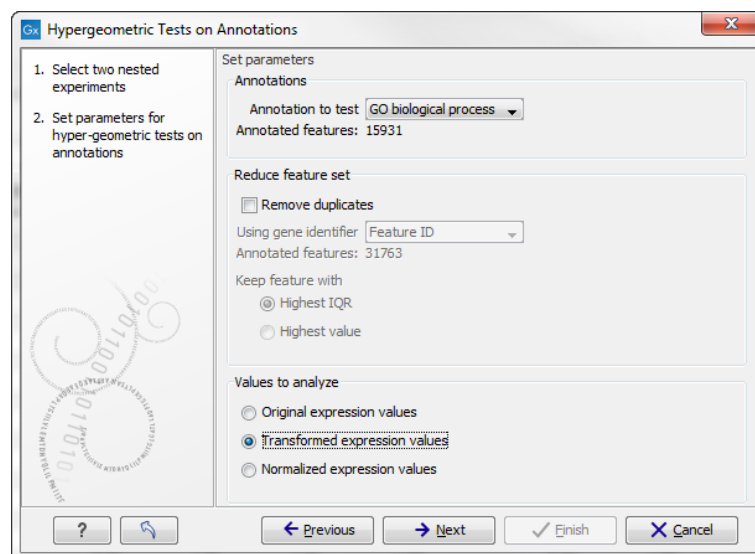

Figure 27.79: Parameters for performing a hypergeometric test on annotations.

At the top, you select which annotation to use for testing. You can select from all the annotations available on the experiment, but it is of course only a few that are biologically relevant. Once you have selected an annotation, you will see the number of features carrying this annotation below.

Annotations are typically given at the gene level. Often a gene is represented by more than one feature in an experiment. If this is not taken into account it may lead to a biased result. The standard way to deal with this is to reduce the set of features considered, so that each gene is represented only once. In the next step, **Remove duplicates**, you can choose the basis on which the feature set will be reduced:

- **Using gene identifier.**
- **Keep feature with:**
 - **Highest IQR.** The feature with the highest interquartile range (IQR) is kept.
 - **Highest value.** The feature with the highest expression value is kept.

First you specify which annotation you want to use as gene identifier. Once you have selected this, you will see the number of features carrying this annotation below. Next you specify which feature

you want to keep for each gene. This may be either the feature with the highest inter-quartile range or the highest value.

At the bottom, you can select which values to analyze (see section 27.4.1). Only features that have a numerical value assigned to them will be used for the analysis. That is, any feature which has a value of plus infinity, minus infinity or NaN will not be included in the feature list taken into the test. Thus, the choice of value at this step can affect the features that are taken forward into the test in two ways:

- If there are features with values of plus infinity, minus infinity or NaN, those features will not be taken forward into the test. This can be a consideration when choosing transformed values, where the mathematical manipulations involved may lead to such values.
- If you chose to remove duplicates, then the value type you choose here is the value used for checking the highest IQR or value to determine which feature is taken forward into the test.

The final number of features used for the test is reported in this history view of the test results.

Click **Next** if you wish to adjust how to handle the results (see section 8.2). If not, click **Finish**.

Result of hypergeometric tests on annotations

The result of performing hypergeometric tests on annotations using GO biological process is shown in figure 27.80.

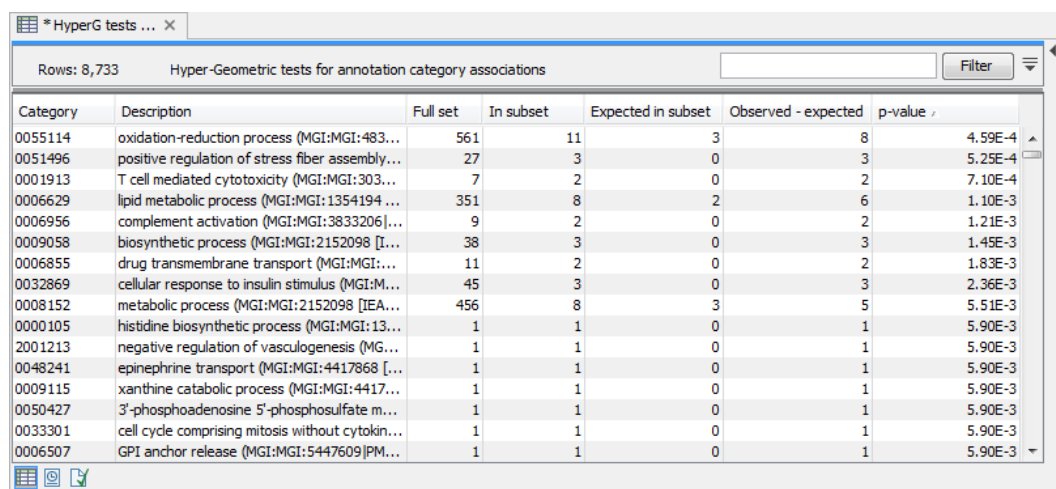

Category	Description	Full set	In subset	Expected in subset	Observed - expected	p-value
0055114	oxidation-reduction process (MGI:MGI:483...	561	11	3	8	4.59E-4
0051496	positive regulation of stress fiber assembly...	27	3	0	3	5.25E-4
0001913	T cell mediated cytotoxicity (MGI:MGI:303...	7	2	0	2	7.10E-4
0006629	lipid metabolic process (MGI:MGI:1354194 ...	351	8	2	6	1.10E-3
0006956	complement activation (MGI:MGI:3833206]...	9	2	0	2	1.21E-3
0009058	biosynthetic process (MGI:MGI:2152098 [I...	38	3	0	3	1.45E-3
0006855	drug transmembrane transport (MGI:MGI:...	11	2	0	2	1.83E-3
0032869	cellular response to insulin stimulus (MGI:M...	45	3	0	3	2.36E-3
0008152	metabolic process (MGI:MGI:2152098 [IEA...	456	8	3	5	5.51E-3
0000105	histidine biosynthetic process (MGI:MGI:13...	1	1	0	1	5.90E-3
2001213	negative regulation of vasculogenesis (MG...	1	1	0	1	5.90E-3
0048241	epinephrine transport (MGI:MGI:4417868 [...	1	1	0	1	5.90E-3
0009115	xanthine catabolic process (MGI:MGI:4417...	1	1	0	1	5.90E-3
0050427	3'-phosphoadenosine 5'-phosphosulfate m...	1	1	0	1	5.90E-3
0033301	cell cycle comprising mitosis without cytokin...	1	1	0	1	5.90E-3
0006507	GPI anchor release (MGI:MGI:5447609]PM...	1	1	0	1	5.90E-3

Figure 27.80: The result of testing on GO biological process.

The table shows the following information:

- **Category.** This is the identifier for the category.
- **Description.** This is the description belonging to the category. Both of these are simply extracted from the annotations.
- **Full set.** The number of features in the original experiment (not the subset) with this category. (Note that this is after removal of duplicates).

- **In subset.** The number of features in the subset with this category. (Note that this is after removal of duplicates).
- **Expected in subset.** The number of features we would have expected to find with this annotation category in the subset, if the subset was a random draw from the full set.
- **Observed - expected.** 'In subset' - 'Expected in subset'
- **p-value.** The tail probability of the hyper geometric distribution This is the value used for sorting the table.

Categories with small p-values are over-represented on the features in the subset relative to the full set.

27.8.2 Gene set enrichment analysis

When carrying out a hypergeometric test on annotations you typically compare the annotations of the genes in a subset containing 'the significantly differentially expressed genes' to those of the total set of genes in the experiment. Which, and how many, genes are included in the subset is somewhat arbitrary - using a larger or smaller p-value cut-off will result in including more or less. Also, the magnitudes of differential expression of the genes is not considered.

The Gene Set Enrichment Analysis (GSEA) does NOT take a sublist of differentially expressed genes and compare it to the full list - it takes a single gene list (a single experiment). The idea behind GSEA is to consider a measure of association between the genes and phenotype of interest (e.g. test statistic for differential expression) and rank the genes according to this measure of association. A test is then carried out for each annotation category, for whether the ranks of the genes in the category are evenly spread throughout the ranked list, or tend to occur at the top or bottom of the list.

The GSEA test implemented here is that of [Tian et al., 2005]. The test implicitly calculates and uses a standard t-test statistic for two-group experiments, and ANOVA statistic for multiple group experiments for each feature, as measures of association. For each category, the test statistics for the features in that category are summed and a category based test statistic is calculated as this sum divided by the square root of the number of features in the category. Note that if a feature has the value NaN in one of the samples, the t-test statistic for the feature will be NaN. Consequently, the combined statistic for each of the categories in which the feature is included will be NaN. Thus, it is advisable to filter out any feature that has a NaN value before applying GSEA.

The p-values for the GSEA test statistics are calculated by permutation: The original test statistics for the features are permuted and new test statistics are calculated for each category, based on the permuted feature test statistics. This is done the number of times specified by the user in the wizard. For each category, the lower and upper tail probabilities are calculated by comparing the original category test statistics to the distribution of the permutation-based test statistics for that category. The lower and higher tail probabilities are the number of these that are lower and higher, respectively, than the observed value, divided by the number of permutations.

As the p-values are based on permutations you may some times see results where category x's test statistic is lower than that of category y and the categories are of equal size, but where the lower tail probability of category x is higher than that of category y. This is due to imprecision

in the estimations of the tail probabilities from the permutations. The higher the number of permutations, the more stable the estimation.

You may run a GSEA on a full experiment, or on a sub-experiment where you have filtered away features that you think are un-informative and represent only noise. Typically you will remove features that are constant across samples (those for which the value in the 'Range' column is zero' – these will have a t-test statistic of zero) and/or those for which the inter-quantile range is small. As the GSEA algorithm calculates and ranks genes on p-values from a test of differential expression, it will generally not make sense to filter the experiment on p-values produced in an analysis of differential expression, prior to running GSEA on it.

Toolbox | Microarray and Small RNA Analysis (📁) | Annotation Test | Gene Set Enrichment Analysis (GSEA) (🖱️)

Select an experiment and click **Next**.

Click **Next**. This will display the dialog shown in figure 27.81.

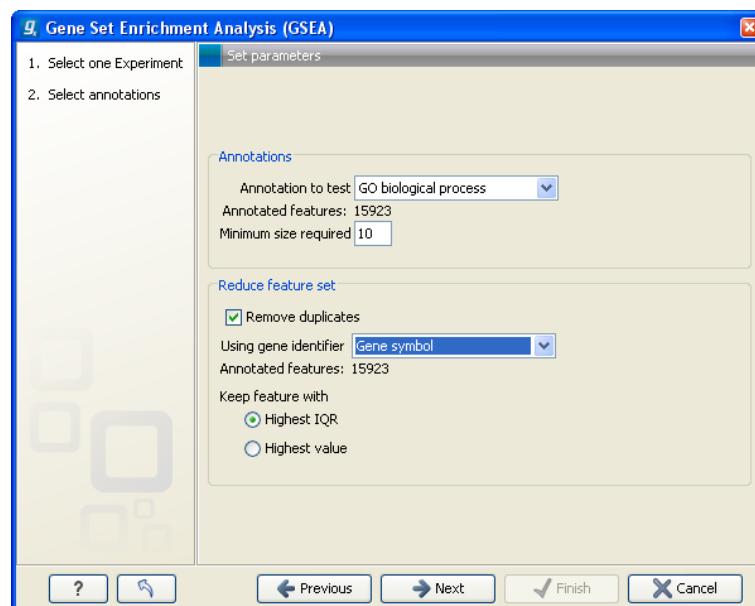

Figure 27.81: Gene set enrichment analysis on GO biological process

At the top, you select which annotation to use for testing. You can select from all the annotations available on the experiment, but it is of course only a few that are biologically relevant. Once you have selected an annotation, you will see the number of features carrying this annotation below.

In addition, you can set a filter: **Minimum size required**. Only categories with more genes (i.e. features) than the specified number will be considered. Excluding categories with small numbers of genes may lead to more robust results.

Annotations are typically given at the gene level. Often a gene is represented by more than one feature in an experiment. If this is not taken into account it may lead to a biased result. The standard way to deal with this is to reduce the set of features considered, so that each gene is represented only once. Check the **Remove duplicates** check box to reduce the feature set, and you can choose how you want this to be done:

- **Using gene identifier.**

- **Keep feature with:**

- **Highest IQR.** The feature with the highest interquartile range (IQR) is kept.
- **Highest value.** The feature with the highest expression value is kept.

First you specify which annotation you want to use as gene identifier. Once you have selected this, you will see the number of features carrying this annotation below. Next you specify which feature you want to keep for each gene. This may be either the feature with the highest inter-quartile range or the highest value.

Clicking **Next** will display the dialog shown in figure 27.82.

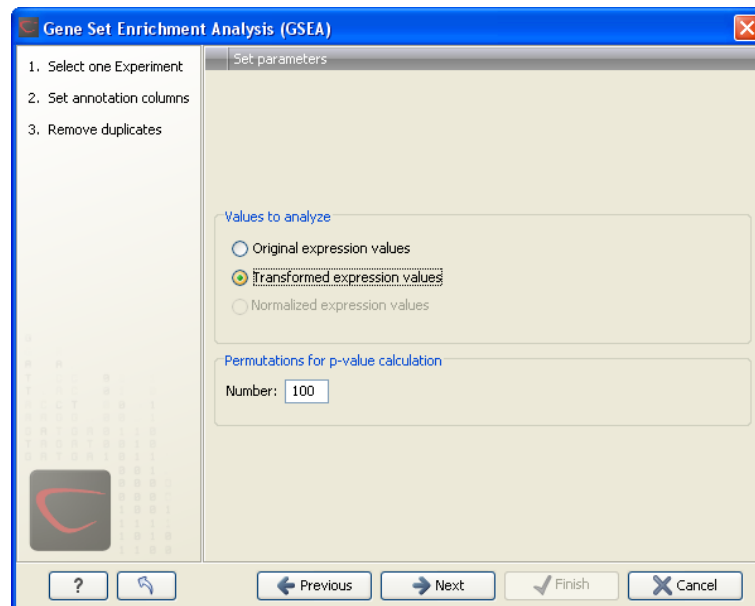

Figure 27.82: Gene set enrichment analysis parameters.

At the top, you can select which values to analyze (see section 27.4.1).

Below, you can set the **Permutations for p-value calculation**. For the GSEA test a p-value is calculated by permutation: p permuted data sets are generated, each consisting of the original features, but with the test statistics permuted. The GSEA test is run on each of the permuted data sets. The test statistic is calculated on the original data, and the resulting value is compared to the distribution of the values obtained for the permuted data sets. The permutation based p-value is the number of permutation based test statistics above (or below) the value of the test statistic for the original data, divided by the number of permuted data sets. For reliable permutation-based p-value calculation a large number of permutations is required (100 is the default).

Click **Next** if you wish to adjust how to handle the results (see section 8.2). If not, click **Finish**.

Result of gene set enrichment analysis

The result of performing gene set enrichment analysis using GO biological process is shown in figure 27.83.

The table shows the following information:

Category	Description	Size	Test statistic	Lower tail	Upper tail
0006412	translation	204	-13,92	0,00	1,00
0006941	striated muscle ...	15	-28,52	0,00	1,00
0006936	muscle contract...	26	-37,56	0,00	1,00
0006937	regulation of m...	17	-30,63	0,00	1,00
0007519	skeletal muscle ...	30	-20,45	1E-4	1,00
0005977	glycogen meta...	19	-19,62	2E-4	1,00
0007517	muscle develop...	21	-15,18	1,7E-3	1,00
0001501	skeletal develo...	42	-14,10	2,1E-3	1,00
0006094	gluconeogenesis	16	-14,19	3,5E-3	1,00
0009749	response to glu...	37	-12,23	5,4E-3	0,99
0006414	translational el...	12	-13,48	6E-3	0,99
0001756	somitogenesis	13	-12,34	6,8E-3	0,99
0007528	neuromuscular ...	13	-12,81	7,8E-3	0,99
0005978	glycogen biosy...	11	-12,03	8,8E-3	0,99
0007200	cathepsin B	25	-12,22	9,7E-3	0,99

Figure 27.83: The result of gene set enrichment analysis on GO biological process.

- **Category.** This is the identifier for the category.
- **Description.** This is the description belonging to the category. Both of these are simply extracted from the annotations.
- **Size.** The number of features with this category. (Note that this is after removal of duplicates).
- **Test statistic.** This is the GSEA test statistic.
- **Lower tail.** This is the mass in the permutation based p-value distribution below the value of the test statistic.
- **Upper tail.** This is the mass in the permutation based p-value distribution above the value of the test statistic.

A small lower (or upper) tail p-value for an annotation category is an indication that features in this category viewed as a whole are perturbed among the groups in the experiment considered.

27.9 General plots



In the **General Plots** folder, you find three general plots that may be useful at various point of your analysis work flow. The plots are explained in detail below.

27.9.1 Histogram

A histogram shows a distribution of a set of values. Histograms are often used for examining and comparing distributions, e.g. of expression values of different samples, in the quality control step of an analysis. You can create a histogram showing the distribution of expression value for a sample:

Toolbox | Microarray and Small RNA Analysis () | General Plots | Create Histogram



Select a number of samples (, , ) or a graph track. When you have selected more than one sample, a histogram will be created for each one. Clicking **Next** will display a dialog as shown in figure 27.84.

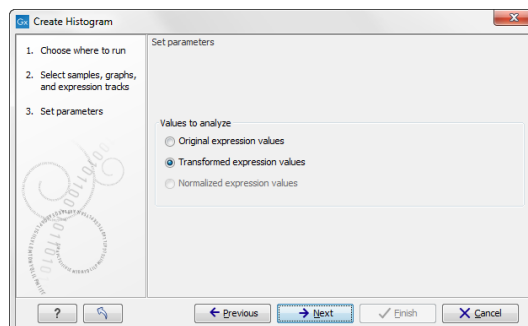

Figure 27.84: Selecting which values the histogram should be based on.

In this dialog, you select the values to be used for creating the histogram (see section 27.4.1). Click **Next** if you wish to adjust how to handle the results (see section 8.2). If not, click **Finish**.

Viewing histograms

The resulting histogram is shown in a figure 27.85

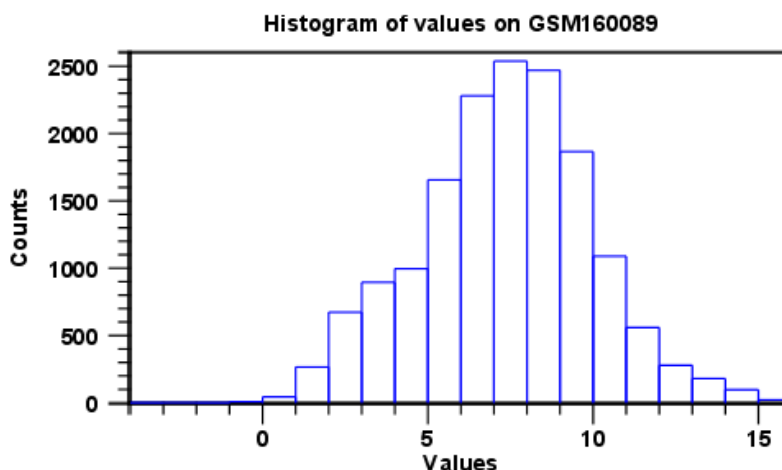

Figure 27.85: Histogram showing the distribution of transformed expression values.

The histogram shows the expression value on the x axis (in the case of figure 27.85 the transformed expression values) and the counts of these values on the y axis.

In the **Side Panel** to the left, there is a number of options to adjust the view. Under **Graph preferences**, you can adjust the general properties of the plot.

- **Lock axes** This will always show the axes even though the plot is zoomed to a detailed level.
- **Frame** Shows a frame around the graph.

- **Show legends** Shows the data legends.
- **Tick type** Determine whether tick lines should be shown outside or inside the frame.
 - Outside
 - Inside
- **Tick lines at** Choosing Major ticks will show a grid behind the graph.
 - None
 - Major ticks
- **Horizontal axis range** Sets the range of the horizontal axis (x axis). Enter a value in **Min** and **Max**, and press Enter. This will update the view. If you wait a few seconds without pressing Enter, the view will also be updated.
- **Vertical axis range** Sets the range of the vertical axis (y axis). Enter a value in **Min** and **Max**, and press Enter. This will update the view. If you wait a few seconds without pressing Enter, the view will also be updated.
- **Break points.** Determines where the bars in the histogram should be:
 - **Sturges method.** This is the default. The number of bars is calculated from the range of values by Sturges formula [Sturges, 1926].
 - **Equi-distanced bars.** This will show bars from **Start** to **End** and with a width of **Sep**.
 - **Number of bars.** This will simply create a number of bars starting at the lowest value and ending at the highest value.

Below the graph preferences, you find **Line color**. Allows you to choose between many different colors. Click the color box to select a color.

Note that if you wish to use the same settings next time you open a principal component plot, you need to save the settings of the **Side Panel** (see section 4.6).

Besides the histogram view itself, the histogram can also be shown in a table, summarizing key properties of the expression values. An example is shown in figure 27.86.

Data	Count
Number +Inf values	0
Number -Inf values	0
Number NaN values	0
Number values used	15923
Total number of values	15923

Figure 27.86: Table view of a histogram.

The table lists the following properties:

- **Number +Inf values**



- **Number -Inf values**
- **Number NaN values**
- **Number values used**
- **Total number of values**

27.9.2 MA plot

The MA plot is a scatter rotated by 45° . For two samples of expression values it plots for each gene the difference in expression against the mean expression level. MA plots are often used for quality control, in particular, to assess whether normalization and/or transformation is required.

You can create an MA plot comparing two samples:

Toolbox | Microarray and Small RNA Analysis () | General Plots | Create MA Plot ()

Select two samples (,  or ). Clicking **Next** will display a dialog as shown in figure 27.87.

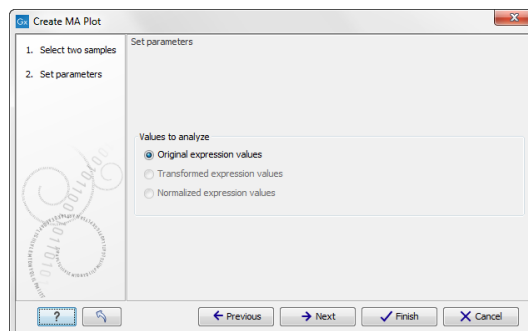

Figure 27.87: Selecting which values the MA plot should be based on.

In this dialog, you select the values to be used for creating the MA plot (see section 27.4.1).

Click **Next** if you wish to adjust how to handle the results (see section 8.2). If not, click **Finish**.

Viewing MA plots

The resulting plot is shown in a figure 27.88.

The X axis shows the mean expression level of a feature on the two samples and the Y axis shows the difference in expression levels for a feature on the two samples. From the plot shown in figure 27.88 it is clear that the variance increases with the mean. With an MA plot like this, you will often choose to transform the expression values (see section 27.4.2).

Figure 27.89 shows the same two samples where the MA plot has been created using \log_2 transformed values.

The much more symmetric and even spread indicates that the dependence of the variance on the mean is not as strong as it was before transformation.

In the **Side Panel** to the left, there is a number of options to adjust the view. Under **Graph preferences**, you can adjust the general properties of the plot.

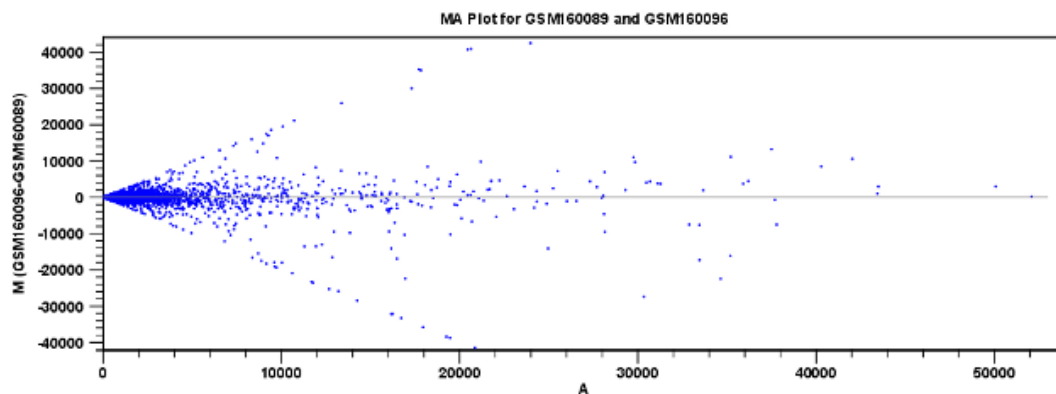

Figure 27.88: MA plot based on original expression values.

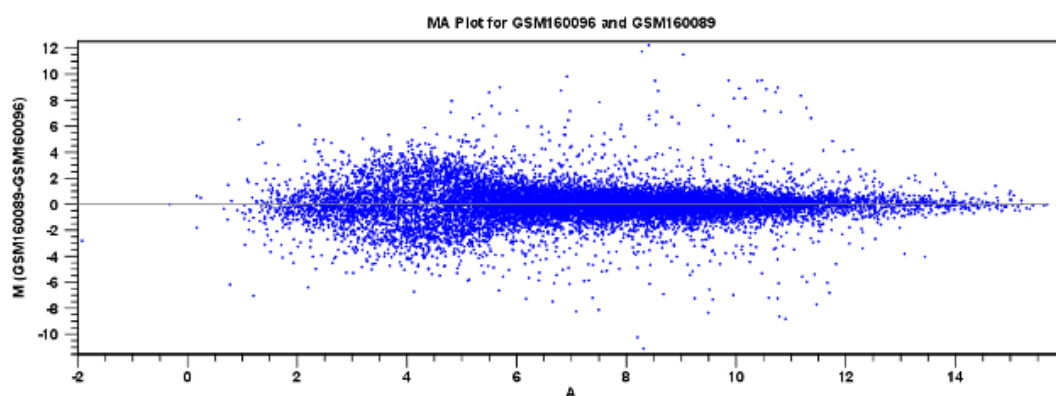

Figure 27.89: MA plot based on transformed expression values.

- **Lock axes** This will always show the axes even though the plot is zoomed to a detailed level.
- **Frame** Shows a frame around the graph.
- **Show legends** Shows the data legends.
- **Tick type** Determine whether tick lines should be shown outside or inside the frame.
 - Outside
 - Inside
- **Tick lines at** Choosing Major ticks will show a grid behind the graph.
 - None
 - Major ticks
- **Horizontal axis range** Sets the range of the horizontal axis (x axis). Enter a value in **Min** and **Max**, and press Enter. This will update the view. If you wait a few seconds without pressing Enter, the view will also be updated.
- **Vertical axis range** Sets the range of the vertical axis (y axis). Enter a value in **Min** and **Max**, and press Enter. This will update the view. If you wait a few seconds without pressing Enter, the view will also be updated.

- **y = 0 axis.** Draws a line where $y = 0$. Below there are some options to control the appearance of the line:

- **Line width**

- * Thin
- * Medium
- * Wide

- **Line type**

- * None
- * Line
- * Long dash
- * Short dash

- **Line color.** Allows you to choose between many different colors. Click the color box to select a color.

- **Line width**

- Thin
- Medium
- Wide

- **Line type**

- None
- Line
- Long dash
- Short dash

- **Line color.** Allows you to choose between many different colors. Click the color box to select a color.

Below the general preferences, you find the **Dot properties** preferences, where you can adjust coloring and appearance of the dots:

- **Dot type**

- None
- Cross
- Plus
- Square
- Diamond
- Circle
- Triangle
- Reverse triangle
- Dot



- **Dot color.** Allows you to choose between many different colors. Click the color box to select a color.

Note that if you wish to use the same settings next time you open a scatter plot, you need to save the settings of the **Side Panel** (see section 4.6).

27.9.3 Scatter plot

As described in section 27.2.4, an experiment can be viewed as a scatter plot. However, you can also create a "stand-alone" scatter plot of two samples:

Toolbox | Microarray and Small RNA Analysis () | General Plots | Create Scatter Plot ()

Select two samples (), () or (). Clicking **Next** will display a dialog as shown in figure 27.90.

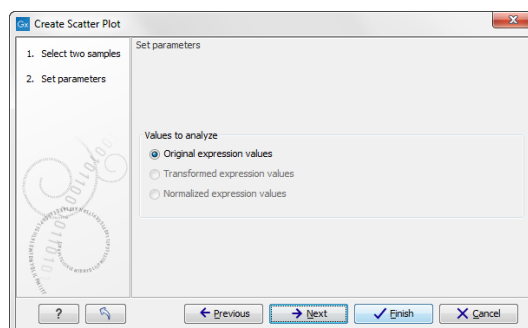

Figure 27.90: *Selecting which values the scatter plot should be based on.*

In this dialog, you select the values to be used for creating the scatter plot (see section 27.4.1).

Click **Next** if you wish to adjust how to handle the results (see section 8.2). If not, click **Finish**.

For more information about the scatter plot view and how to interpret it, please see section 27.2.4.

Chapter 28

De novo sequencing

Contents

28.1	<i>De novo</i> assembly	895
28.1.1	Best practices	896
28.1.2	How it works	899
28.1.3	Resolve repeats using reads	901
28.1.4	Automatic paired distance estimation	904
28.1.5	Optimization of the graph using paired reads	905
28.1.6	AGP export	907
28.1.7	Bubble resolution	908
28.1.8	Converting the graph to contig sequences	909
28.1.9	Summary	909
28.1.10	Randomness in the results	910
28.1.11	SOLiD data support in <i>de novo</i> assembly	910
28.1.12	<i>De novo</i> assembly parameters	911
28.1.13	<i>De novo</i> assembly report	913
28.2	Map reads to contigs	915

28.1 *De novo* assembly

The *de novo* assembly algorithm of *CLC Genomics Workbench* offers comprehensive support for a variety of data formats, including both short and long reads, and mixing of paired reads (both insert size and orientation).

The *de novo* assembly process has two stages:

1. First, simple contig sequences are created by using all the information that are in the read sequences. This is the actual *de novo* part of the process. These simple contig sequences do not contain any information about which reads the contigs are built from. This part is elaborated in section [28.1.2](#).

2. Second, all the reads are mapped using the simple contig sequence as reference. This is done in order to show e.g. coverage levels along the contigs and enabling more downstream analysis like SNP detection and creating mapping reports. Note that although a read aligns to a certain position on the contig, it does not mean that the information from this read was used for building the contig, because the mapping of the reads is a completely separate part of the algorithm.

If you wish to only have the simple contig sequences as output, this can be chosen when starting the de novo assembly (see section [28.1.12](#)).

28.1.1 Best practices

The de novo assembler is not designed to effectively use long mate-pair read information (insert size greater than 10 kp). Such data can be incorporated but may not lead to improvements in the final results. If paired end data are being assembled, the inclusion of mate-pair information in the same assembly can sometimes lead to worse results. In such cases, we advise that the long mate-pair data is marked as single (non-paired) data before including it in the assembly (see section [6.3.9](#)).

Before you begin the Assembly

Input Data Quality Good quality data is key to a successful assembly. We strongly recommend using the Trim Sequences tool:

- Trimming based on Quality can reduce the number of sequencing errors input to the assembler. This reduces the number of spurious words generated during an initial assembly phase. This then lowers the overhead of dealing with the consequences of sequencing errors in later phases of the assembly. Specifically, this reduces the number of Words that will need to be discarded in the graph building stage.
- Trimming Adapters from sequences is crucial for generating correct results. Adapter sequences remaining on sequences can lead to the assembler spending much time trying to join regions that are not biologically relevant. In other words this can lead to the assembly taking a long time and yielding misleading results.

Input Data Quantity In the case of de novo assembly, more data does not always lead to a better result. Very high coverage in a location will increase the probability this location is seen as a sequencing error. This is not good because overlapping sequencing errors can result in poor assembly quality. We therefore recommend to use data sets with an average read coverage less than 100x. If you expect the average coverage of your genome to be greater than 100x, you can use the Sample Reads tool to reduce coverage. To determine how many reads you need to sample to obtain a maximum average coverage of 100x, you can do the following calculation:

- Obtain an estimated size of the genome you intend to assemble.
- Multiply this genome size by 100. This value will be the total number of bases you should use as input for assembly.
- Divide the total input bases the average length of your sequencing reads.
- Use this number as input for the number of reads to obtain as output from the Sample Reads tool

Running the Assembly The two parameters that can be adjusted to improve assembly quality are Word Size and Bubble Size.

The default values for these parameters can work reasonably well on a range of data sets, but we recommend that you choose and evaluate these values based on what you know about your data.

Word Size If you expect your data to contain long regions of high quality, a larger Word Size, such as a value above 30 is recommended. If your data has a higher error rate, as in cases when homopolymer errors are common, a Word Size below 30 is recommended. Whenever possible, the Word Size should be less than the expected number of bases between sequencing errors.

Bubble Size When adjusting Bubble Size, the repeat structure of your genome should be considered in conjunction with the sequence quality. If you do not expect a repetitive genome you may wish to choose a higher bubble size to improve contiguity. If you anticipate more repeats, you may wish to use a smaller Bubble Size to reduce the possibility of collapsing repeat regions. In cases where the sequence quality is not high a larger bubble size may make more sense for your data.

If you are not sure of what parameters would be best suited for your data, we recommend identifying optimal settings for your de novo assembly empirically. To do so, you may run multiple assembly jobs with different parameters and compare the results.

However, comparing the results of multiple assemblies is often a challenge. For example, you may have one assembly with a large N50 and another with a larger total contig length. How do you decide which is better? Is the one with the large contig sizes better or the one with more total sequence? Ultimately, the answer to these questions will depend on what the goal of your downstream analysis is. To help with this comparison, we provide some basic guidelines in the sections below.

Evaluating and Refining the Assembly

Three key points to look for in assessing assembly quality are contiguity, completeness, and correctness.

Contiguity: How many contigs are there?

A high N50 and low number of contigs, relative to your expected number of chromosomes is ideal. If you aren't sure what type of N50 and contig number might be reasonable to expect, you could try to get an idea by looking at existing assemblies of a similar genome, should these exist. For an even better sense of what would be reasonable for your data, you could make comparisons to an assembly of a similar genome, assembled using a similar amount and type of data. If your assembly results include a large number of very small contigs, it may be that you set the minimum contig length filter too low. Very small contigs, particularly those of low coverage, can generally be ignored.

Completeness: How much of the genome is captured in the assembly?

If a total genome length of 5MB is expected based on existing literature or similar genomes that have already been assembled, but the sum of all contig lengths is only 3.5MB, you may wish to reconsider your assembly parameters.

Two common reasons for an assembly output that is shorter than expected are:

- A Word Size that is higher than optimal for your data: A high Word Size will increase the probability of discarding words because they overlap with sequencing errors. If a word is seen only once, the unique word will be discarded, even if there exist many other words that are identical except for one base (eg. a sequencing error). A discarded word will not be considered in constructing the assembly graph and will therefore be excluded from the assembly contig sequences.
- A Bubble Size that is higher than optimal for your data: A high Bubble Size will increase the probability that two similar sequences are classified as a repeat and thus collapsed into a single contig. It is sometimes possible to identify collapsed repeats by looking at the mapping of your reads to the assembled contigs. A collapsed repeat will show as a high peak of coverage in one location.

Depending on the resources available for the organism you are working on, you might also assess assembly completeness by mapping the assembled contig sequences to a known reference. You can then check for regions of the reference genome that have not been covered by the assembled contigs. Whether this is sensible depends on the sample and reference organisms and what is known about their expected differences.

Correctness Do the contigs that have been assembled accurately represent the genome?

One key question in assessing correctness is whether the assembly is contaminated with any foreign organism sequence data. To check this, you could run a BLAST search using your assembled contigs as query sequences against a database containing possible contaminant species data. In addition to BLAST, checking the coverage can help to identify contaminant sequence data. The coverage of a contaminant contig is often different from the desired organism so you can compare the potential contaminant contigs to the rest of the assembled contigs. You may check for these types of coverage differences between contigs by:

- Map your reads use as input for de novo assembly to your contigs (if you do not already have mapping output)
- Create a Detailed Mapping Report
- In the Result handling step of the wizard, check the option to Create separate table with statistics for each mapping
- Review the average coverage for each contig in this resulting table.

If there are contigs that have good matches to a very different organism and there are discernable coverage differences, you could either consider removing those contigs from the assembly, or run a new assembly after removing the contaminant reads. One way to remove the contaminant reads would be to run a read mapping against the foreign organism's genome and to check the option to Collect un-mapped reads. The un-mapped reads Sequence List should now be clean of the contamination. You can then use this set of reads in a new de novo assembly.

Assessing the correctness of an assembly also involves making sure the assembler did not join segments of sequences that should not have been joined - or checking for mis-assemblies. This is more difficult. One option for identifying mis-assemblies is to try running the InDels and Structural Variants tool. If this tool identifies structural variation within the assembly, that could indicate an issue that should be investigated.

Post assembly improvements

If you are working with a smaller genome, the **CLC Genome Finishing Module** may be of interest to you. It has been developed to help finishing small genomes, such as microbes, eukaryotic parasites, or fungi, in order to reduce the extensive workload associated with genome finishing and to facilitate as many steps in the procedure as possible. Request a free trial at <https://www.qiagenbioinformatics.com/products/clc-genome-finishing-module/>.

28.1.2 How it works

Our de novo assembly algorithm works by using de Bruijn graphs. This is similar to how most new de novo assembly algorithms work [Zerbino and Birney, 2008, Zerbino et al., 2009, Li et al., 2010, Gnerre et al., 2011]. The basic idea is to make a table of all sub-sequences of a certain length (called words) found in the reads. The words are relatively short, e.g. about 20 for small data sets and 27 for a large data set (the word size is determined automatically, see explanation below).

Given a word in the table, we can look up all the potential neighboring words (in all the examples here, word of length 16 are used) as shown in figure 28.1.

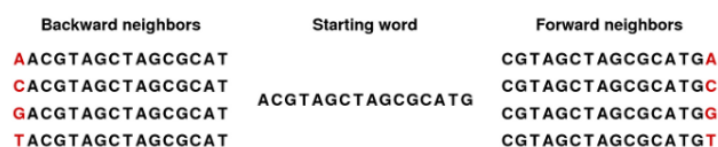

Figure 28.1: The word in the middle is 16 bases long, and it shares the 15 first bases with the backward neighboring word and the last 15 bases with the forward neighboring word.

Typically, only one of the backward neighbors and one of the forward neighbors will be present in the table. A graph can then be made where each node is a word that is present in the table and edges connect nodes that are neighbors. This is called a de Bruijn graph.

For genomic regions without repeats or sequencing errors, we get long linear stretches of connected nodes. We may choose to reduce such stretches of nodes with only one backward and one forward neighbor into nodes representing sub-sequences longer than the initial words.

Figure 28.2 shows an example where one node has two forward neighbors:



Figure 28.2: Three nodes connected, each sharing 15 bases with its neighboring node and ending with two forward neighbors.

After reduction, the three first nodes are merged, and the two sets of forward neighboring nodes are also merged as shown in figure 28.3.

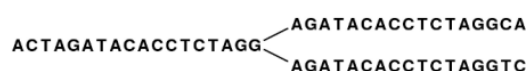

Figure 28.3: The five nodes are compacted into three. Note that the first node is now 18 bases and the second nodes are each 17 bases.

So bifurcations in the graph leads to separate nodes. In this case we get a total of three nodes

after the reduction. Note that neighboring nodes still have an overlap (in this case 15 nucleotides since the word length is 16).

Given this way of representing the de Bruijn graph for the reads, we can consider some different situations:

When we have a *SNP* or a *sequencing error*, we get a so-called bubble (this is explained in detail in section 28.1.7) as shown in figure 28.4.



Figure 28.4: A bubble caused by a heterozygous SNP or a sequencing error.

Here, the central position may be either a C or a G. If this was a sequencing error occurring only once, we would see that one path through the bubble will only be words seen a single time. On the other hand if this was a heterozygous SNP we would see both paths represented more or less equally. Thus, having information about how many times this particular word is seen in all the reads is very useful and this information is stored in the initial word table together with the words.

The most difficult problem for de novo assembly is repeats. Repeat regions in large genomes often get very complex: a repeat may be found thousands of times and part of one repeat may also be part of another repeat. Sometimes a repeat is longer than the read length (or the paired distance when pairs are available) and then it becomes impossible to resolve the repeat. This is simply because there is no information available about how to connect the nodes before the repeat to the nodes after the repeat.

In the simple example, if we have a *repeat sequence* that is present twice in the genome, we would get a graph as shown in figure 28.5.



Figure 28.5: The central node represents the repeat region that is represented twice in the genome. The neighboring nodes represent the flanking regions of this repeat in the genome.

Note that this repeat is 57 nucleotides long (the length of the sub-sequence in the central node above plus regions into the neighboring nodes where the sequences are identical). If the repeat had been shorter than 15 nucleotides, it would not have shown up as a repeat at all since the word length is 16. This is an argument for using long words in the word table. On the other hand, the longer the word, the more words from a read are affected by a sequencing error. Also, for each extra nucleotide in the words, we get one less word from each read. This is in particular an issue for very short reads. For example, if the read length is 35, we get 16 words out of each read if the word length is 20. If the word length is 25, we get only 11 words from each read.

To strike a balance, our de novo assembler chooses a word length based on the amount of input data: the more data, the longer the word length. It is based on the following:

```
word size 12: 0 bp - 30000 bp
word size 13: 30001 bp - 90002 bp
word size 14: 90003 bp - 270008 bp
word size 15: 270009 bp - 810026 bp
word size 16: 810027 bp - 2430080 bp
```

```
word size 17: 2430081 bp - 7290242 bp
word size 18: 7290243 bp - 21870728 bp
word size 19: 21870729 bp - 65612186 bp
word size 20: 65612187 bp - 196836560 bp
word size 21: 196836561 bp - 590509682 bp
word size 22: 590509683 bp - 1771529048 bp
word size 23: 1771529049 bp - 5314587146 bp
word size 24: 5314587147 bp - 15943761440 bp
word size 25: 15943761441 bp - 47831284322 bp
word size 26: 47831284323 bp - 143493852968 bp
word size 27: 143493852969 bp - 430481558906 bp
word size 28: 430481558907 bp - 1291444676720 bp
word size 29: 1291444676721 bp - 3874334030162 bp
word size 30: 3874334030163 bp - 11623002090488 bp
etc.
```

This pattern (multiplying by 3) continues until word size of 64 which is the max. Please note that the range of word sizes is 12-24 on 32-bit computers and 12-64 on 64-bit computers. See how to adjust the word size in section [28.1.12](#)

28.1.3 Resolve repeats using reads

Having build the de Bruijn graph using words, our de novo assembler removes repeats and errors using reads. This is done in the following order:

- Remove weak edges
- Remove dead ends
- Resolve repeats using reads without conflicts
- Resolve repeats with conflicts
- Remove weak edges
- Remove dead ends

Each phase will be explained in the following subsections.

Remove weak edges

The de Bruijn graph is expected to contain artifacts from errors in the data. The number of reads agreeing upon an error is likely to be low especially compared to the number of reads without errors for the same region. When this relative difference is large enough, it's possible to conclude something is an error.

In the remove weak edges phase we consider each node and calculate the number c_1 of edges connected to the node and the number of times k_1 a read is passing through these edges. An average of reads going through an edge is calculated $avg_1 = k_1/c_1$ and then the process is repeated using only those edges which have more than or equal avg_1 reads going through it. Let

c_2 be the number of edges which meet this requirement and k_2 the number of reads passing through these edges. A second average $avg_2 = k_2/c_2$ is used to calculate a limit,

$$limit = \frac{\log(avg_2)}{2} + \frac{avg_2}{40}$$

and each edge connected to the node which has less than or equal $limit$ number of reads passing through it will be removed in this phase.

Remove dead ends

Some read errors might occur more often than expected, either by chance or because they are systematic sequencing errors. These are not removed by the "Remove weak edges" phase and will cause "dead ends" to occur in the graph, which are short paths in the graph that terminate after a few nodes. Furthermore, the "Remove weak edges" sometimes only removes a part of the graph, which will also leave dead ends behind. Dead ends are identified by searching for paths in the graph where there exists an alternative path containing four times more nucleotides. All nodes in such paths are then removed in this step.

Resolve repeats without conflicts

Repeats and other shared regions between the reads lead to ambiguities in the graph. These must be resolved otherwise the region will be output as multiple contigs, one for each node in the region.

The algorithm for resolving repeats without conflicts considers a number of nodes called the *window*. To start with, a window only contains one node, say R . We also define the *border nodes* as the nodes outside the window connected to a node in the window. The idea is to divide the border nodes into sets such that border nodes A and C are in the same set if there is a read going through A , through nodes in the window and then through C . If there are strictly more than one of these sets we can resolve the repeat area, otherwise we expand the window.

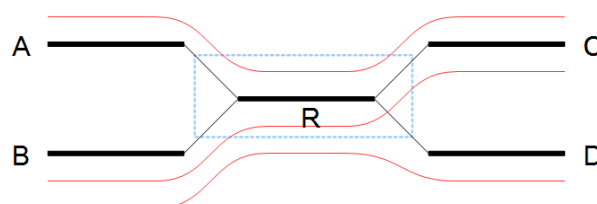

Figure 28.6: A set of nodes.

In the example in figure 28.6 all border nodes A , B , C and D are in the same set since one can reach every border nodes using reads (shown as red lines). Therefore we expand the window and in this case add node C to the window as shown in figure 28.7.

After the expansion of the window, the border nodes will be grouped into two groups being set A , E and set B , D , F . Since we have strictly more than one set, the repeat is resolved by copying the nodes and edges used by the reads which created the set. In the example the resolved repeat is shown in figure 28.8.

The algorithm for resolving repeats without conflict can be described the following way:

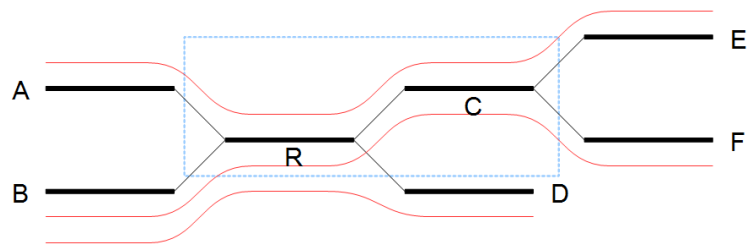

Figure 28.7: Expanding the window to include more nodes.

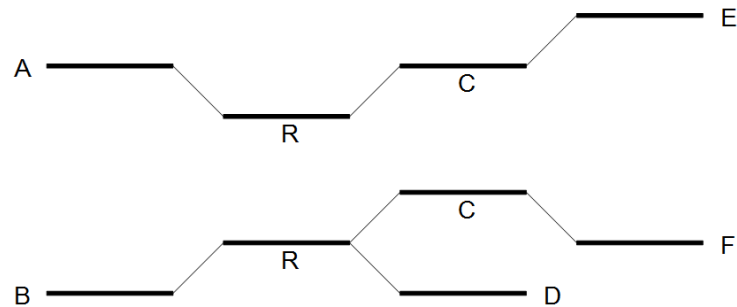

Figure 28.8: Resolving the repeat.

1. A node is selected as the window
2. The border is divided into sets using reads going through the window. If we have multiple sets, the repeat is resolved.
3. If the repeat cannot be resolved, we expand the window with nodes if possible and go to step 2.

The above steps are performed for every node.

Resolve repeats with conflicts

In the previous section repeats were resolved without excluding any reads that goes through the window. While this lead to a simpler graph, the graph will still contain artifacts, which have to be removed. The next phase removes most of these errors and is similar to the previous phase:

1. A node is selected as the initial window
2. The border is divided into sets using reads going through the window. If we have multiple sets, the repeat is resolved.
3. If the repeat cannot be resolved, the border nodes are divided into sets using reads going through the window where reads containing errors are excluded. If we have multiple sets, the repeat is resolved.
4. The window is expanded with nodes if possible and step 2 is repeated.

The algorithm described above is similar to the algorithm used in the previous section, except step 3 where the reads with errors are excluded. This is done by calculating an average $avg_1 = m_1/c_1$ where m_1 is the number of reads going through the window and c_1 is the number

of distinct pairs of border nodes having one (or more) of these reads connecting them. A second average $avg_2 = m_2/c_2$ is calculated where m_2 is the number of reads going through the window having at least avg_1 or more reads connecting their border nodes and c_2 the number of distinct pairs of border nodes having avg_1 or more reads connecting them. Then, a read between two border nodes B and C is excluded if the number of reads going through B and C is less than or equal to $limit$ given by

$$limit = \frac{\log(avg_2)}{2} + \frac{avg_2}{16}$$

An example where we resolve a repeat with conflicts is given in 28.9 where we have a total of 21 reads going through the window with $avg_1 = 21/3 = 7$, $avg_2 = 20/2 = 10$ and $limit = 1/2 + 10/16 = 1.125$. Therefore all reads between border nodes B and C are excluded resulting in two sets of border nodes A, C and B, D . The resolved repeat is shown in figure 28.10.

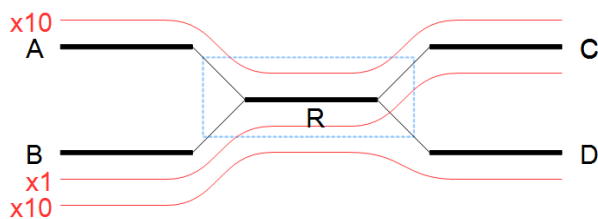

Figure 28.9: A repeat with conflicts.

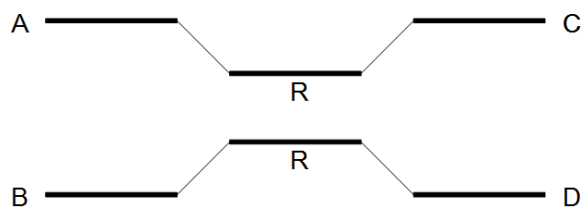

Figure 28.10: Resolving a repeat with conflicts.

28.1.4 Automatic paired distance estimation

The default behavior of the de novo assembler is to use the paired distances provided by the user. If the automatic paired distance estimation is enabled, the assembler will attempt to estimate the distance between paired reads. This is done by analysing the mapping of paired reads to the long unambiguous paths in the graph which are created in the read optimization step described above. The distance estimation algorithm creates a histogram (H) of the paired distances between reads in each set of paired reads (see figure 28.11). Each of these histograms are then used to estimate paired distances as described in the following.

We denote the average number of observations in the histogram $H_{avg} = \frac{1}{|H|} \sum_d H(d)$ where $H(d)$ is the number of observations (reads) with distance d and $|H|$ is the number of bins in H . The gradient of H at distance d is denoted $H'(d)$. The following algorithm is then used to compute a distance interval for each histogram.

- Identify peaks in H as $\max_{i \leq d \leq j} H(d)$ where $[i, j]$ is any interval in H where $\{H(d) \geq \frac{H_{avg}}{2} | i \leq d \leq j\}$.

- For the two largest peaks found, expand the respective intervals $[i, j]$ to $[k, l]$ where $H'(k) < 0.001 \wedge k \leq i \wedge H'(l) > -0.001 \wedge j \leq l$. I.e. we search for a point in both directions where the number of observations becomes stable. A window of size 5 is used to calculate H' in this step.
- Compute the total number of observations in each of the two expanded intervals.
- If only one peak was found, the corresponding interval $[k, l]$ is used as the distance estimate unless the peak was at a negative distance in which case no distance estimate is calculated.
- If two peaks were found and the interval $[k, l]$ for the largest peak contains less than 1% of all observations, the distance is not estimated.
- If two peaks were found and the interval $[k, l]$ for the largest peak contain $<2X$ observations compared to the smaller peak, the distance estimate is only computed if one peak was at a positive distance and the other was at a negative distance. If this is the case the interval $[k, l]$ for the positive peak is used as a distance estimate.
- If two peaks were found and the largest peak has $\geq 2X$ observations compared to the smaller peak, the interval $[k, l]$ corresponding to the largest peak is used as the distance estimate.

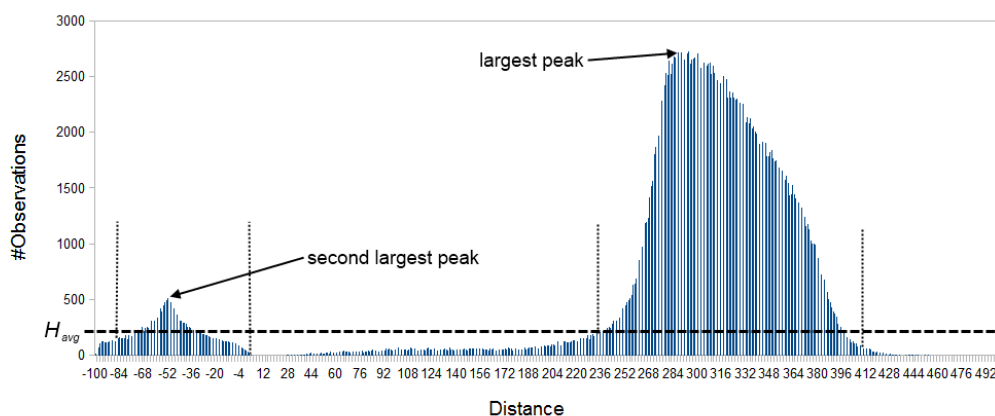

Figure 28.11: Histogram of paired distances where H_{avg} is indicated by the horizontal dashed line. There is two peaks, one is at a negative distance while the other larger peak is at a positive distance. The extended interval $[k, l]$ for each peak is indicated by the vertical dotted lines.

28.1.5 Optimization of the graph using paired reads

When paired reads are available, we can use the paired information to resolve large repeat regions that are not spanned by individual reads, but are spanned by read pairs. Given a set of paired reads that align to two nodes connected by a repeat region, the repeat region may be resolved for those nodes if we can find a path connecting the nodes with a length corresponding to the paired read distance. However, such a path must be supported by a minimum of four sets of paired reads before the repeat is resolved.

If it's not possible to resolve the repeat, scaffolding is performed where paired read information is used to determine the distances between contigs and the orientation of these. Scaffolding is only considered between two contigs if both are at least 120 bp long, to ensure that enough paired read information is available. An iterative greedy approach is used when performing scaffolding where short gaps are closed first, thus increasing the paired read information available for closing gaps (see figure 28.12).

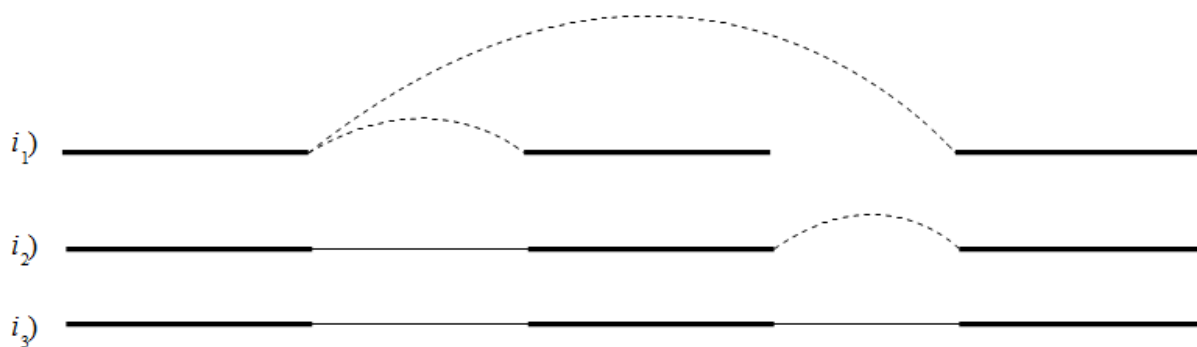



Figure 28.12: Performing iterative scaffolding of the shortest gaps allows long pairs to be optimally used. i_1 shows three contigs with dashed arches indicating potential scaffolding. i_2 is after first iteration when the shortest gap has been closed and long potential scaffolding has been updated. i_3 is the final results with three contigs in one scaffold.

Contigs in the same scaffold are output as one large contig with Ns inserted in between. The number of Ns inserted correspond to the estimated distance between contigs, which is calculated based on the paired read information. More precisely, for each set of paired reads spanning two contigs a distance estimate is calculated based on the supplied distance between the reads. The average of these distances is then used as the final distance estimate. The distance estimate will often be negative which happens when the paired information indicate that two contigs overlap. The assembler will attempt to align the ends of such contigs and if a high quality overlap is found the contigs are joined into a single contig. If no overlap is found, the distance estimate is set to two so that all remaining scaffolds have positive distance estimates.

Furthermore, Ns can also be present in output contigs in cases where input sequencing reads themselves contain Ns.

Please note that in CLC Genomics Workbench 6.0.1, Genomics Server 5.0.1, Assembly Cell 4.0.2 and all earlier versions of these products a performance optimization gave rise to Ns being inserted in certain non-scaffold regions, which in the current version can be solved with reads covering such specific regions.

Additional information about repeats being resolved using paired reads and scaffolded contigs is available as annotations on the contig sequences and as summary in the report (see section 28.1.13). This information can also be exported in AGP format (see section 28.1.6).

The annotations in table format can be viewed by clicking the "Show Annotation Table" icon  at the bottom of the viewing area. "Show annotation types" in the side panel allows you to select the annotation "Scaffold" among a list of other annotations. The annotations tell you about the scaffolding that was performed by the de novo assembler. That is, it tells you where particular contigs, those areas containing complete sequence information, were joined together across regions without complete sequence information.

For the GFF format there are three types of annotations:

- **Scaffold** refers to the estimated gap region between two contigs where Ns are inserted.
- **Contigs joined** refers to the join of two contigs connected by a repeat or another ambiguous structure in the graph, which was resolved using paired reads. Can also refer to overlapping contigs in a scaffold that were joined using an overlap.
- **Alternatives excluded** refers to the exclusion of a region in the graph using paired reads, which resulted in a join of two contigs.

28.1.6 AGP export

The AGP annotations describe the components that an assembly consists of. This format can be validated by the NCBI AGP validator.

If the exporter is executed on an assembly where the contigs have been updated using a read mapping, the N's in some scaffolds might be resolved if you select the option "Update contigs" (figure 28.13).

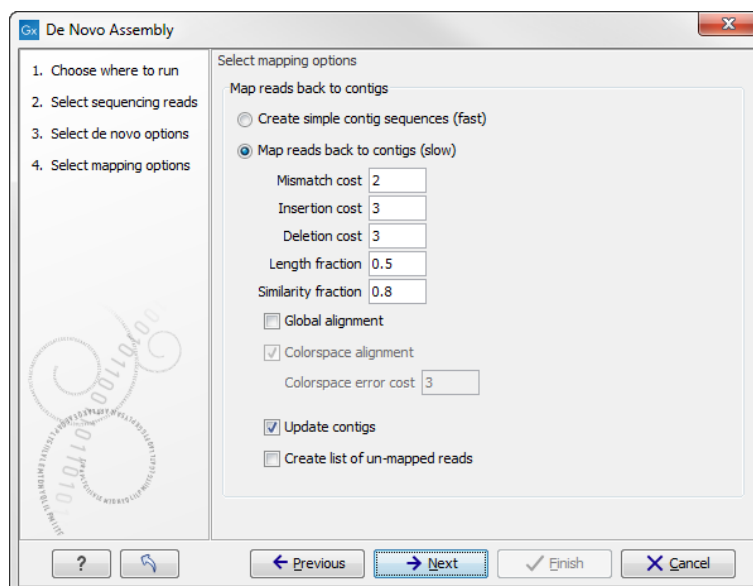

Figure 28.13: Select "update contigs" by ticking the box if you want to resolve scaffolds based on a read mapping.

If the exporter encounters such a region, it will give a warning but not stop. If the exporter is executed on an assembly from GWB versions older than 6.5, it will often stop with an error saying that it encountered more than 10 N's which wasn't marked as a scaffold region. In this case the user would have to rerun the assembly with GWB version 6.5 or newer of the de novo assembler if they wish to be able to export to AGP.

Currently we output two types of annotations in AGP format:

- **Contig** a non-redundant sequence not containing any scaffolded regions.
- **Scaffold** the estimated gap region between two contigs.

28.1.7 Bubble resolution

Before the graph structure is converted to contig sequences, bubbles are resolved. As mentioned previously, a bubble is defined as a bifurcation in the graph where a path furcates into two nodes and then merge back into one. An example is shown in figure 28.14.



Figure 28.14: A bubble caused by a heterozygous SNP or a sequencing error.

In this simple case the assembler will collapse the bubble and use the route through the graph that has the highest coverage of reads. For a diploid genome with a heterozygous variant, there will be a fifty-fifty distribution of reads on the two variants, and this means that the choice of one allele over the other will be arbitrary. If heterozygous variants are important, they can be identified after the assembly by mapping the reads back to the contig sequences and performing standard variant calling. For random sequencing errors, it is more straightforward; given a reasonable level of coverage, the erroneous variant will be suppressed.

Figure 28.15 shows an example of a data set where the reads have systematic errors. Some reads include five As and others have six. This is a typical example of the homopolymer errors seen with the 454 and Ion Torrent platforms.

```

:AGATGACCAGGGTGTTCGATAAAAAATGCCAATCATCTGGAC,
:AGATGACCAGGGTGTTCGAT - AAAAAATGCCAATCATCTGGAC,
:AGATGACCAGGGTGTTCGAT - AAAAAATGCCAATCATCTGGAC,
:AGATGACCAGGGTGTTCGAT - AAAAAATGCCAATCATCTGGAC,
:AGATGACCAGGGTGTTCGATAAAAAATGCCAATCATCTGGAC,
:AGATGACCAGGGTGTTCGATAAAAAATGCCAATCATCTGGAC,
:AGATGACCAGGGTGTTCGAT - AAAAAATGCCAATCATCTGGAC,
:AGATGACCAGGGTGTTCGAT - AAAAAATGCCAATCATCTGGAC,
:AGATGACCAGGGTGTTCGAT - AAAAAATGCCAATCATCTGGAC,
:AGATGACCAGGGTGTTCGAT - AAAAAATGCCAATCATCTGGAC,
:AGATGACCAGGGTGTTCGAT - AAAAAATGCCAATCATCTGGAC,

```

Figure 28.15: Reads with systematic errors.

When these reads are assembled, this site will give rise to a bubble in the graph. This is not a problem in itself, but if there are several of these sites close together, the two paths in the graph will not be able to merge between each site. This happens when the distance between the sites is smaller than the word size used (see figure 28.16).

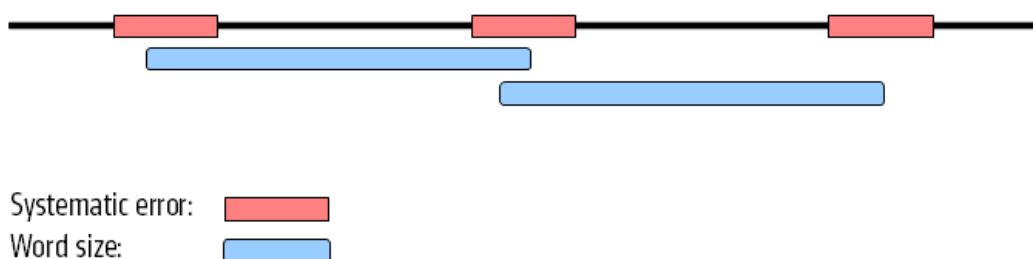

Figure 28.16: Several sites of errors that are close together compared to the word size.

In this case, the bubble will be very large because there are no complete words in the regions between the homopolymer sites, and the graph will look like figure 28.17.

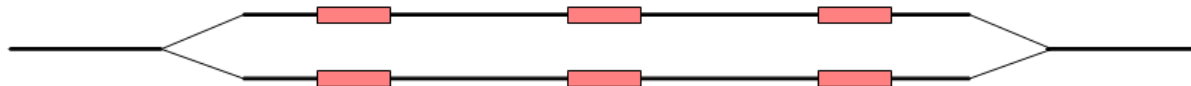

Figure 28.17: *The bubble in the graph gets very large.*

If the bubble is too large, the assembler will have to break it into several separate contigs instead of producing one single contig.

The maximum size of bubbles that the assembler should try to resolve can be set by the user. In the case from figure 28.17, a bubble size spanning the three error sites will mean that the bubble will be resolved (see figure 28.18).

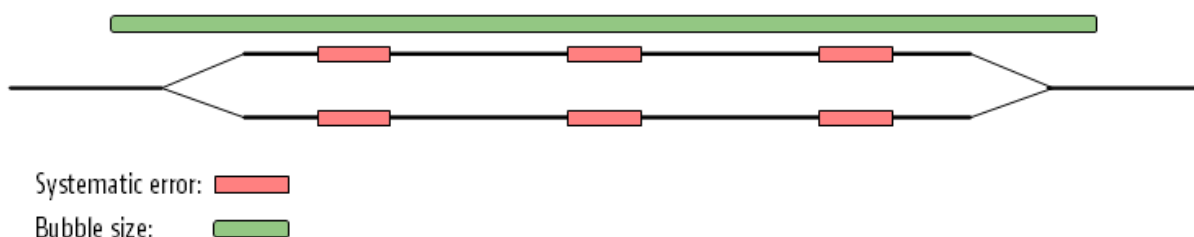

Figure 28.18: *The bubble size needs to be set high enough to encompass the three sites.*

While the default bubble size is often fine when working with short, high quality reads, considering the bubble size can be especially important for reads generated by sequencing platforms yielding long reads with either systematic errors or a high error rate. In such cases, a higher bubble size is recommended. For example, as a starting point, one could try half the length of the average read in the data set and then experiment with increasing and decreasing the bubble size in small steps. For data sets with a high error rate it is often necessary to increase the bubble size to the maximum read length or more. Please keep in mind that increasing the bubble size also increases the chance of misassemblies.

28.1.8 Converting the graph to contig sequences

The output of the assembly is not a graph but a list of contig sequences. When all the previous optimization and scaffolding steps have been performed, a contig sequence will be produced for every non-ambiguous path in the graph. If the path cannot be fully resolved, Ns are inserted as an estimation of the distance between two nodes as explained in section 28.1.5.

28.1.9 Summary

So in summary, the de novo assembly algorithm goes through these stages:

- Make a table of the words seen in the reads.
- Build a *de Bruijn* graph from the word table.
- Use the reads to resolve the repeats in the graph.
- Use the information from paired reads to resolve larger repeats and perform scaffolding if necessary.

- Output resulting contigs based on the paths, optionally including annotations from the scaffolding step.

These stages are all performed by the assembler program.

28.1.10 Randomness in the results

Different runs of the de novo assembler can result in slightly different results. This is caused by multi-threading of the program combined with the use of probabilistic data structures. If you were to run the assembler using a single thread, the effect would not be observed. That is, the same results would be produced in every run. However, an assembly run on a single thread would be very slow. The assembler should run quickly. Thus, we use multiple threads to accelerate the program.

The main reason for the assembler producing different results in each run is that threads construct contigs in an order that is correlated with the thread execution order, which we do not control. The size and "position" of a contig can change dramatically if you start building a contig from two different starting points (i.e. different words, or k-mers), which means that different assembly runs can lead to different results, depending on the order in which threads are executed. Whether a contig is scaffolded with another contig can also be affected by the order that contigs are constructed. In this case, you could see quite large differences in the lengths of some contigs reported. This will be particularly noticeable if you have an assembly with reasonably few contigs of great length.

We are working on addressing the fact that slightly different output is returned with different runs of the de novo assembler without appreciably affecting the speed of the assembler. For the moment, the output of runs may vary slightly, but the overall information content of the assembly should not be markedly different.

28.1.11 SOLiD data support in de novo assembly

SOLiD sequencing is done in color space. When viewed in nucleotide space this means that a single sequencing error changes the remainder of the read. An example read is shown in figure 28.19.



Figure 28.19: How an error in color space leads to a phase shift and subsequent problems for the rest of the read sequence

Basically, this color error means that C's become A's and A's become C's. Likewise for G's and T's. For the three different types of errors, we get three different ends of the read. Along with the correct reads, we may get four different versions of the original genome due to errors. So if SOLiD reads are just regarded in nucleotide space, we get four different contig sequences with jumps from one to another every time there is a sequencing error.

Thus, to fully accommodate SOLiD sequencing data, the special nature of the technology has to be considered in every step of the assembly algorithm. Furthermore, SOLiD reads are fairly short

and often quite error prone. Due to these issues, we have chosen not to include SOLiD support in the first algorithm steps, but only use the SOLiD data where they have a large positive effect on the assembly process: when applying paired information.

28.1.12 De novo assembly parameters

To start the assembly:

Toolbox | **De Novo Sequencing** (📁) | **De Novo Assembly** (🔧)

In this dialog, you can select one or more sequence lists or single sequences.

Click **Next** to set the parameters for the assembly. This will show a dialog similar to the one in figure 28.20.

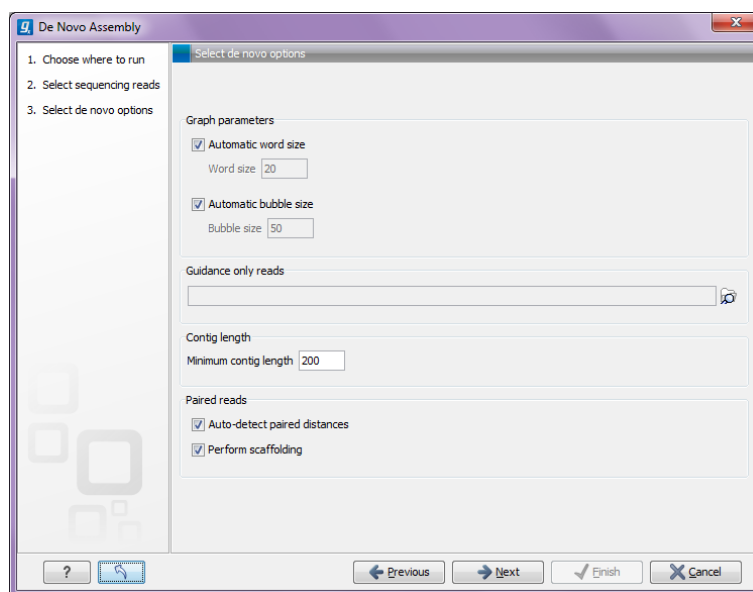

Figure 28.20: Setting parameters for the assembly.

At the top, you select the **Word size** and the **Bubble size** to be used. The principles of setting the word size are described in section 28.1.2. When using automatic calculation, you can see the word size in the **History** (📄) of the result files. Please note that the range of word sizes is 12-24 on 32-bit computers and 12-64 on 64-bit computers.

The meaning of the bubble size parameter is explained in section 28.1.7. The automatic bubble size is set to 50, unless one of the following conditions apply:

- some of the reads are from either 454, Ion torrent or PacBio;
- the reads are not all Sanger reads and average read length of all input reads is >160bp.

In these cases the bubble size is set to the average read length of all input reads. The value used is also recorded in the **History** (📄) of the result files.

The next option is to specify **Guidance only reads**. The reads supplied here will not be used to create the *de Bruijn* graph and subsequent contig sequence but only used to resolved ambiguities in the graph (see section 28.1.3 and section 28.1.5). With mixed data sets from

different sequencing platforms, we recommend using sequencing data with low error rates as the main input for the assembly, whereas data with more errors should be specified only as **Guidance only reads**. This would typically be long reads or paired data sets.

You can also specify the **Minimum contig length** when doing de novo assembly. Contigs below this length will not be reported. The default value is 200 bp. For very large assemblies, the number of contigs can be huge (over a million), in which case the data structures when mapping reads back to contigs will be very large and take a very long time to handle. In this case, it is a great advantage to raise the minimum contig length to reduce the number of contigs that have to be incorporated into this data structure.

At the bottom, there is an option to **Perform scaffolding**. The scaffolding step is explained in greater detail in section 28.1.5. This will also cause scaffolding annotations to be added to the contig sequences (except when you also choose to Update contigs, see below).

Finally, there is an option to **Auto-detect paired distances**. This will determine the paired distance (insert size) of paired data sets. If several paired sequence lists are used as input, a separate calculation is done for each one to allow for different libraries in the same run. The **History** (📄) view of the result will list the distance used for each data set.

If the automatic detection of pairs is not checked, the assembler will use the information about minimum and maximum distance recorded on the input sequence lists (see section 6.3.9).

For mate-pair data sets with large insert sizes, it may not be possible to infer the correct paired distance. In this case, the automatic distance calculation should not be used.

The best way of checking this is to run a read mapping using the contigs from the de novo assembly as reference and the mate-pair library as reads, and then check the mapping report (see section 24.3.2). There is a paired distance distribution graph that can be used to check whether the distance estimated by the assembler fits in the distribution found in the read mapping.

When you click **Next**, you will see the dialog shown in figure 28.21

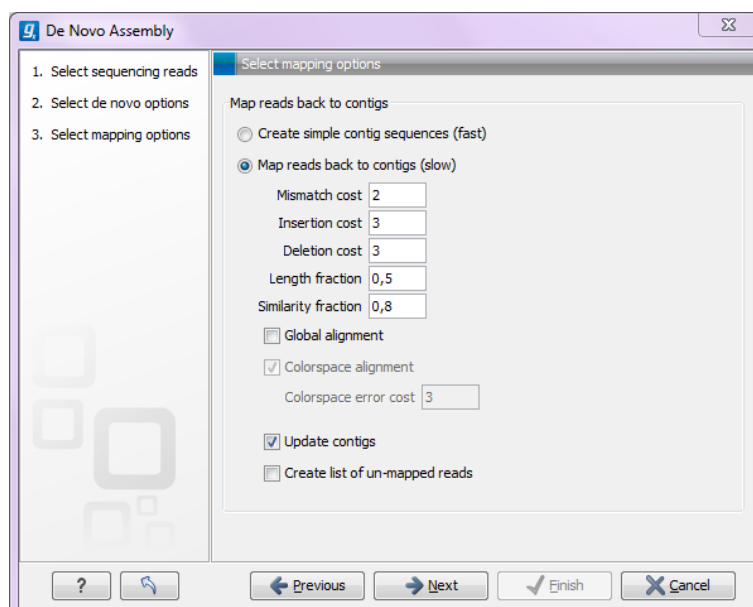

Figure 28.21: Parameters for mapping reads back to the contigs.

At the top, you choose whether a read mapping should be performed after the initial contig creation. If chosen, you can specify some parameters for the read mapping. The mapping options offered in the wizard are explained in section 24.1.3. The placement of reads that map in more than one position equally well are placed randomly (see section 24.1.5) and the type of gap costs used here are linear.

At the bottom, you can choose to Update contigs based on the subsequent mapping of the input reads back to the contigs generated by the de novo assembly. In general terms, this has the effect of updating the contig sequences based on the evidence provided by the subsequent mapping back of the read data to the de novo assembled contigs. The following are the impacts of choosing this option:

- Contig regions must be supported by at least one read mapping back to them in order to be included in the output. If more than half of the reads in a column of the mapping contain a gap, then a gap will be entered into the contig sequence. Contig regions where no reads map will be removed. Note that if such a region occurs within a contig, it is removed and the surrounding regions are joined together.
- The most common nucleotide among the mapped reads at a given position is the one assigned to the contig sequence. In NGS data, it would be very unlikely that at a given position there would be an equal number of reads with different nucleotides. Should this occur however, then the nucleotide that comes first in the alphabet would be included in the consensus.

Note that if this option is selected, the contig lengths may get below the threshold specified in figure 28.20 because this threshold is applied to the original contig sequences. If the **Update contigs based on mapped reads** option is not selected, the original contig sequences from the assembler will be preserved completely also in situations where the reads that are mapped back do not support the contig sequences.

28.1.13 De novo assembly report

In the last dialog of the de novo assembly, you can choose to create a report of the results (see figure 28.22).

The report contains the following information when both scaffolding and read mapping is performed:

Nucleotide distribution This includes Ns when scaffolding has been performed.

Contig measurements This section includes statistics about the number and lengths of contigs. When scaffolding is performed and the update contigs option is not selected, there will be two separate sections with these numbers: one including the scaffold regions with Ns and one without these regions.

- **N25, N50 and N75** The N25 contig set is calculated by summarizing the lengths of the biggest contigs until you reach 25 % of the total contig length. The minimum contig length in this set is the number that is usually used to report the N25 value of a de novo assembly. The same goes with N50 and N75 which are the 50 % and 75 % of the total contig length, respectively.

1 Summary de novo report

1.1 Nucleotide distribution

Nucleotide	Count	Frequency
Adenine (A)	1.113.919	24,5%
Cytosine (C)	1.142.129	25,2%
Guanine (G)	1.157.663	25,5%
Thymine (T)	1.118.847	24,6%
Any nucleotide (N)	6.409	0,1%

1.2 Contig measurements

	Length
N75	41.694
N50	80.414
N25	132.325
Minimum	202
Maximum	191.299
Average	32.421
Count	140
Total	4.538.967

Figure 28.22: *Creating a de novo assembly report.*

- **Minimum, maximum and average** This refers to the contig lengths.
- **Count** The total number of contigs.
- **Total** The number of bases in the result. This can be used for comparison with the estimated genome size to evaluate how much of the genome sequence is included in the assembly.

Accumulated contig lengths This shows the summarized contig length on the y axis and the number of contigs on the x axis, with the biggest contigs ranked first. This answers the question: how many contigs are needed to cover e.g. half of the genome.

If the de novo assembly was followed by a read mapping, it is possible to have the following additional sections.

Summary statistics Gives the count, average length and total bases amount for all reads, matched and non-matched reads, contigs, reads in pairs, and broken paired reads.

Distribution of read length For each sequence length, you can see the number of reads and the distribution in percent. This is mainly useful if you don't have too much variance in the lengths as you have in Sanger sequencing data for example.

Distribution of matched read length Equivalent to the above, except that this includes only the reads that have been matched to a contig.

Distribution of non-matched read length Show the distribution of lengths of the unmapped sequences.

Paired reads distance distribution Show the distribution of paired reads distances.

For a more detailed report, use the **Create Detailed Mapping Report** found in the NGS Core Tools folder of the toolbox, and see the description of the report in section 24.3.2.

28.2 Map reads to contigs

The "Map reads to contigs" tool allows mapping of reads to contigs. This can be relevant in situations such as when:

- Contigs have been imported from an external source
- The output from a de novo assembly is contigs with no read mapping
- You wish to map a new set of reads or a subset of reads to the contigs

Hence, in any situation where the reference of a mapping is contigs, the "Map reads to contigs" tool can be useful. The "Map reads to contigs" tool is similar to the "Map reads to Reference" tool in that both tools make use of the same read mapper and accept the same input reads. The main difference between the two tools is the output. The output from the "Map reads to contigs" tool is a de novo object that can be edited, which is in contrast to the reference sequence used when mapping reads to a reference.

To run the "Map reads to contigs" tool:

Toolbox | De Novo Sequencing (📁) | Map Reads to Contigs (🔍)

This opens up the dialog in figure 28.23.

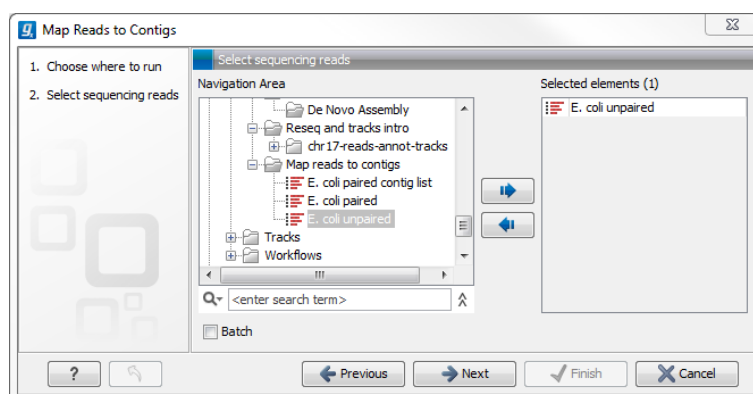

Figure 28.23: Select reads. The contigs will be selected in the next step.

The next step is to select the contigs to map the reads against (figure 28.24). Under "Contig masking", specify whether to include or exclude specific regions (for a description of this see section 24.1.2). The contigs can be updated as part of the "Map Reads to Contigs" tool by selecting "Update contigs" at the bottom of the wizard. The advantage of using the read mapping in "Map Reads to Contigs" tool to update the contigs is that the read mapper is better than the de novo assembler at handling errors in reads.

The next wizard steps are identical to the steps found in the "Map Reads to Reference" tool. For a description of these steps, please see section 24.1.3).

The output from the "Map Reads to Contigs" tool depends on whether tracks or stand-alone read mappings were selected in the last dialog. When stand-alone read mappings have been selected

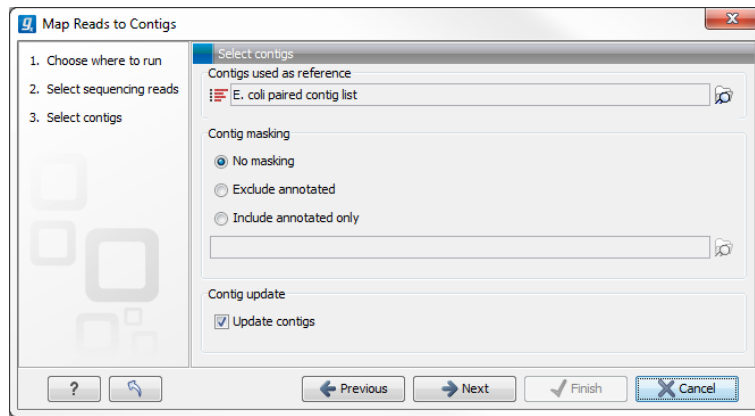

Figure 28.24: Select contigs and specify whether to use masking and the "Update contigs" function.

as output, it is possible to edit and delete in the contig sequences. Figure 28.25 shows the result of using "Map Reads to Reference" (top) and "Map Reads to Contigs" (bottom) on the exact same reads and contigs as input. Contig 1 from both analyses have been opened from their respective Contig Tables. The differences are highlighted with red arrows. Note that the output from the "Map Reads to Contigs" do not have a consensus sequence as the Contig itself will be the consensus sequence if "Update contigs" was selected.

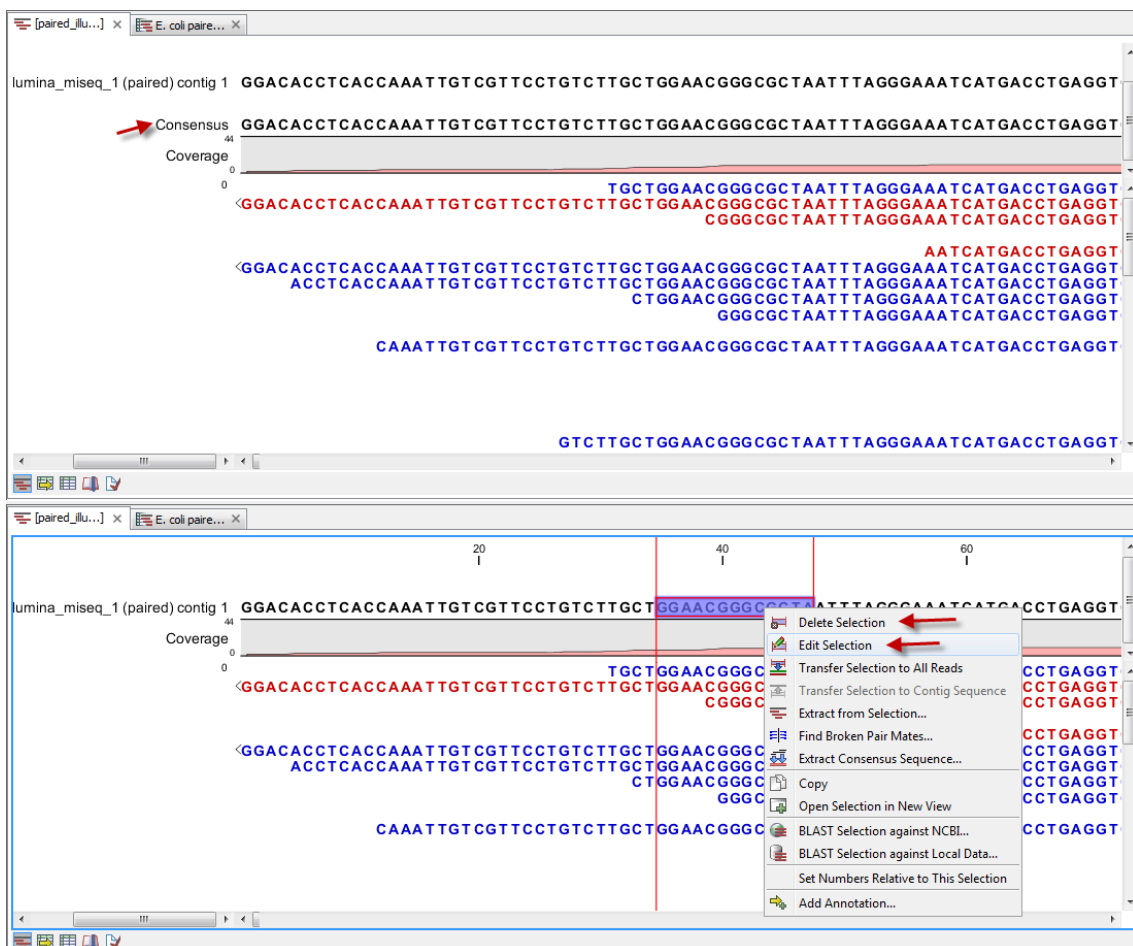

Figure 28.25: Two different read mappings performed with "Map Reads to Reference" (top) and "Map Reads to Contigs" (bottom). The differences are highlighted with red arrows.

By selecting "Update contigs" at the bottom of the wizard, the contigs generated by the de novo assembly are used as references that the reads used for the assembly input are mapped back to. The contigs themselves are updated based on the mapping results of the "Map Reads to Contigs". One advantage of using the read mapping in "Map Reads to Contigs" tool to update the contigs is that the read mapper is better than the de novo assembler at handling errors in reads. Specifically, the actions taken when contigs are updated are:

- Regions of a contig reference, where no reads map, are removed. This leads to the surrounding regions of the contig to be put together as one (figure 28.25).
- In the case of locations where reads map to a contig reference, but there are some mismatches to that contig, the contig sequence is updated to reflect the majority base at that location among the reads mapped there. If more than half of the reads contain a gap at that location, the contig sequence will be updated to include the gap.

Before the contig is updated:

```
Reference: AACCTT
Read 1    AA
Read 2           TT
```

After the contig is updated:

```
Reference: AATT
Read 1:    AA
Read 2:           TT
```

Figure 28.26: When selecting "Update Contig" in the wizard, contigs will be updated according to the reads. This means that regions of a contig where no reads map will be removed.

Chapter 29

Epigenomics

Contents

29.1 ChIP-Seq Analysis	918
29.1.1 Quality Control of ChIP-Seq data	919
29.1.2 Learning peak shapes	920
29.1.3 Applying peak shape filters to call peaks	921
29.1.4 Running the Transcription Factor ChIP-Seq tool	921
29.2 Annotate with nearby gene information	924

29.1 ChIP-Seq Analysis

Chromatin immunoprecipitation followed by high-throughput sequencing (ChIP-Seq) is a method for analyzing DNA-protein interactions. Peak finding is an essential post-processing step in the analysis and interpretation of ChIP-Seq data and many tools that have been developed specifically for this purpose.

Most peak callers are difficult to parametrize such that they accurately discriminate active and inactive promoter regions [Rye et al., 2011, Heydarian et al., 2014]. Nevertheless, these peaks are clearly visible to the human eye since they show a distinct shape. The Transcription Factor ChIP-Seq tool takes a different approach, which is conceptually intuitive and modular by learning the shape of the signal from the data. The parametrization is done by giving positive and negative examples of peak shapes, making the parametrization process explicit and easily understandable.

The Transcription Factor ChIP-Seq tool uses this approach to identify genomic regions with significantly enriched read coverage and a read distribution with a characteristic shape.

ChIP-Seq data analysis is typically based on identification of genomic regions where the signal (i.e. number of mapped reads) is significantly enriched. The detection of the enrichment is based on a background model or the comparison with a ChIP-Seq sample where the immunoprecipitation step is omitted. The shape of the signal from ChIP-Seq data depends on which protein was targeted in the immunoprecipitation reaction [Stanton et al., 2013, Kumar et al., 2013]. For example, the typical signal shape of a transcription factor binding site like NRSF shows a high concentration of forward reads followed by a high concentration of reverse reads (figure 29.1).

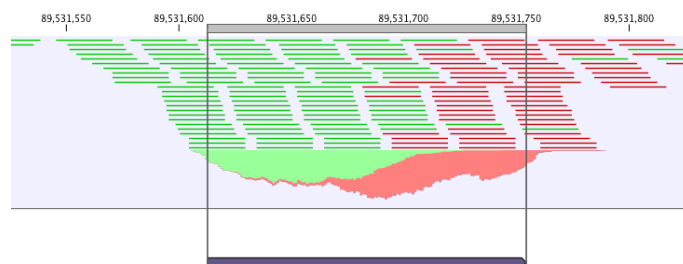

Figure 29.1: Distribution of forward (green) and reverse (red) reads around a binding site of the transcription factor NRSF.

The tool makes use of this characteristic shape to identify enriched regions (peaks) in ChIP-Seq data.

29.1.1 Quality Control of ChIP-Seq data

During the first step of the analysis, the Transcription Factor ChIP-Seq tool analyzes the input to check if the input data satisfy the assumptions made by the algorithm and to compute several quality measures. The cross-correlation between reads mapping in the forward and in the reverse strand is often used to investigate the quality of ChIP-Seq experiments [Landt et al., 2012, Marinov et al., 2014]. The quality is determined with respect to the two main peaks of the cross-correlation plot (figure 29.2), the peak at the read length (often called a phantom peak [Landt et al., 2012]) and the one at the fragment length. The peak at the fragment length is typically higher than the peak at the read length and the background (figure 29.2) for successful ChIP-Seq experiments.

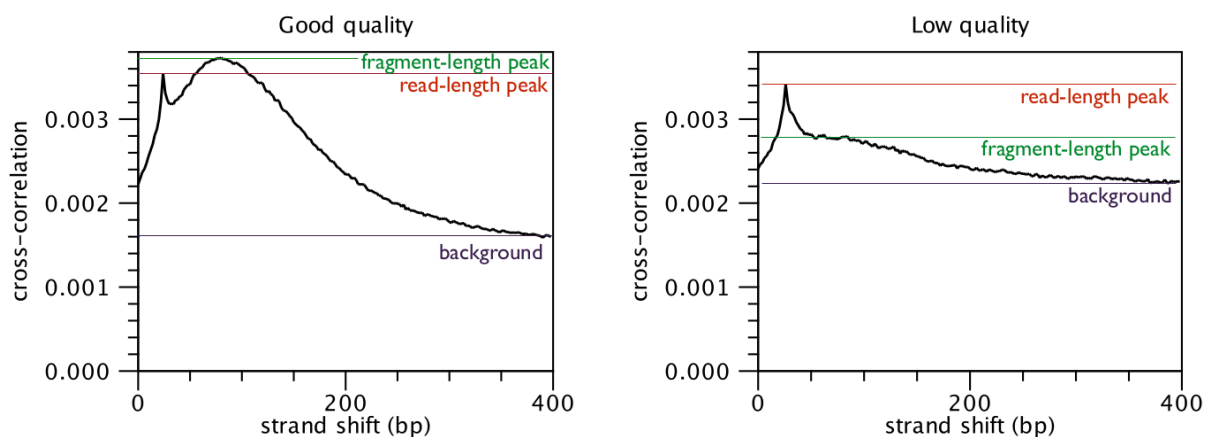

Figure 29.2: Difference in cross-correlation profiles in ChIP experiments of good and low quality.

For each input file of the analysis, the Transcription Factor ChIP-Seq tool calculates and reports several quality measures. Those quality measures have been investigated by the modENCODE consortium and are described in more detail in [Landt et al., 2012]. The quality measures are:

Number of mapped reads For mammalian cells (e.g. human and mouse), this value should be at least 10 million reads. For smaller organisms such as worm and fly, this value should be at least 2 million reads.

Normalized strand coefficient The normalized strand coefficient describes the ratio between the fragment-length peak and the background cross-correlation values. This value should be greater than 1.05 for ChIP-Seq experiments.

Relative strand correlation The relative strand correlation describes the ratio between the fragment-length peak and the read-length peak in the cross-correlation plot. This value should be high (at least 0.8) for transcription factor binding sites, which have a concentrated signal. However, this value can be low even for successful ChIP-Seq experiments on histone modifications [Landt et al., 2012].

29.1.2 Learning peak shapes

In order to learn a characteristic shape from ChIP-Seq data, the Transcription Factor ChIP-Seq tool analyzes the genomic coverage of the reads. For each read mapping, the 5' position of the reads mapping in the forward strand and the 3' position of the reads mapping in the reverse strand are extracted. Those values are then normalized to create a coverage value for the forward and the reverse strand. In order to learn the characteristic peak shape of ChIP-Seq data, the Transcription Factor ChIP-Seq tool identifies a set of positive regions, i.e. regions with very apparent peaks. Those regions are easy to find and are typically found by every peak-caller. The Transcription Factor ChIP-Seq tool identifies these regions by finding areas with very high coverage in the ChIP-Seq data. The average shape of the positive regions of the NRSF transcription factor is shown in for the forward and reverse strand in figure 29.3.

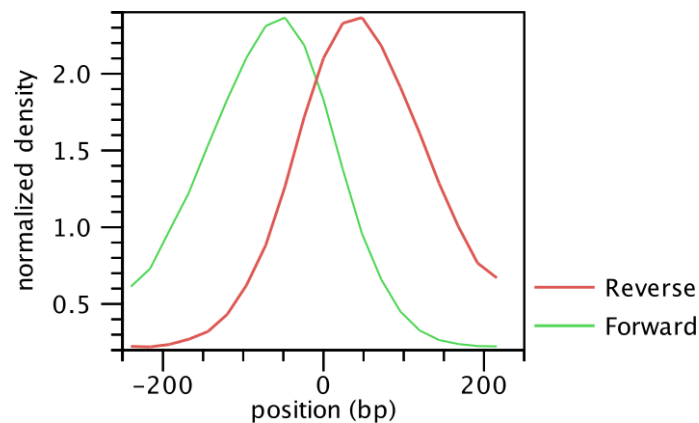

Figure 29.3: Average peak shape of the transcription factor NRSF.

Next, the Transcription Factor ChIP-Seq tool builds a filter, which can be used to identify genomic regions whose read coverage profile matches the characteristic peak shape and to determine the statistical significance of this match. In order to build such a filter, examples of positive (e.g. ChIP-Seq peaks) and negative (e.g. background noise, PCR artifacts) profiles are needed as input. The Transcription Factor ChIP-Seq tool uses regions with very high coverage in the experiment ChIP-Seq as positive examples. If control ChIP-Seq experiments are given, regions with high coverage in the control and low in the experimental ChIP-Seq data are used as negative examples, as they are probably originated from PCR artifacts. If there is no information to build a negative profile from, the profile is estimated from the sequencing noise.

Once the positive and negative regions have been identified, the Transcription Factor ChIP-Seq tool learns a filter that matches the average peak shape, which we term peak shape filter. The filter implemented is called Hotelling Observer and was chosen because it is the matched filter that maximizes the AUCROC (Area Under the Curve of the Receiver Operator Characteristic), one of the most widely used measures for algorithmic performance.

The Hotelling observer h is defined as:

$$h = \left(\frac{R_p + R_n}{2} \right)^{-1} (\mathbb{E}[X_p] - \mathbb{E}[X_n]), \quad (29.1)$$

where $\mathbb{E}[X_p]$ is the average profile of the *positive* regions, $\mathbb{E}[X_n]$ is the average profile of the *negative* regions, while R_p and R_n denote the covariance matrices between the *positive* and *negative* profiles, respectively. The Hotelling Observer has already previously been successfully used for calling ChIP-Seq peaks [Kumar et al., 2013]. An example of Hotelling observer is shown in figure 29.4.

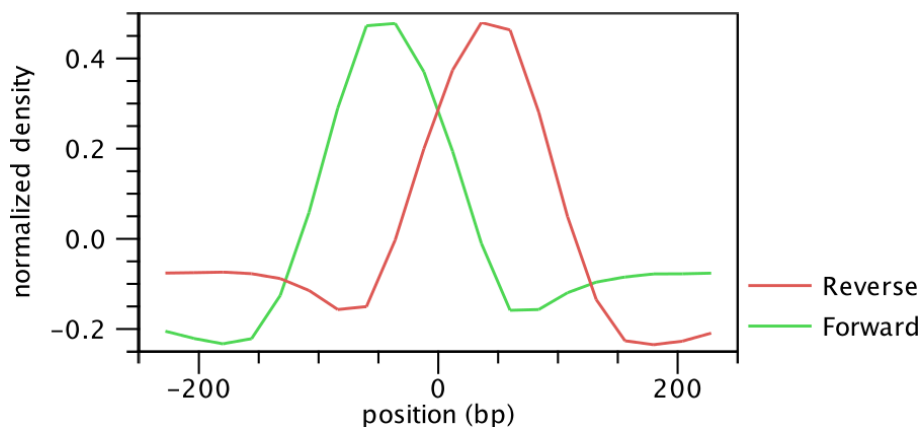

Figure 29.4: Peak shape filter for the transcription factor NR5F.

29.1.3 Applying peak shape filters to call peaks



The peak shape filter is then applied to the experimental data and a score is calculated at each genomic position. The score is obtained by extracting the genomic coverage profile of a window centered at the genomic position and then comparing this profile to the peak shape filter. The result of this comparison is defined as peak shape score. The peak shape score is standardized and follows a standard normal distribution, so a p-value for each genomic position can be calculated as $p\text{-value} = \Phi(-\text{Peak shape score of the peak center})$, where Φ is the standard normal cumulative distribution function.

Once the peak shape score for the complete genome is calculated, peaks are identified as genomic regions where the maximum peak shape score is greater than a given threshold. The center of the peak is then identified as the genomic region with the highest peak shape score and the boundaries are determined by the genomic positions where the peak shape score becomes negative.

29.1.4 Running the Transcription Factor ChIP-Seq tool

To run the Transcription Factor ChIP-Seq tool:

Toolbox | Epigenomics Analysis  | **Transcription Factor ChIP-Seq** 

This will open up the wizard shown in figure 29.5 where you can select the input data (the mapped ChIP-Seq reads). Multiple inputs (e.g. replicate experiments) are accepted, provided that they refer to the same genome. Track based read mappings  and stand-alone read mappings  /  are both accepted.

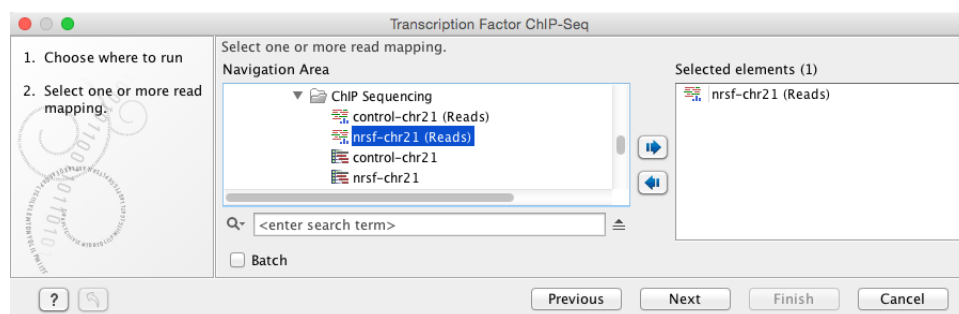

Figure 29.5: Select the input data for the Transcription Factor ChIP-Seq tool.

Click on the button labeled **Next** to go to the next wizard step (shown in figure 29.6).

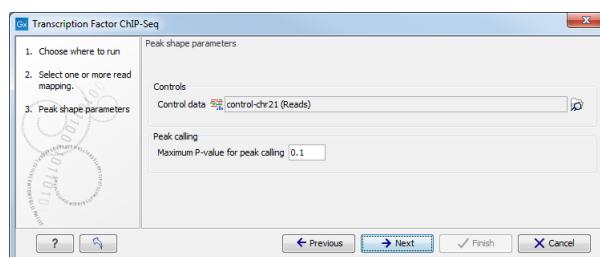

Figure 29.6: Options for the Transcription Factor ChIP-Seq tool.

In this wizard step you have the following options:

- **Control data** The control data, typically a ChIP-Seq sample where the immunoprecipitation step is omitted, can be specified in this option.
- **Maximum P-value for peak calling** The threshold for reporting peaks can be specified by this option.

Click on the button labeled **Next** to go to the wizard step shown in figure 29.7.

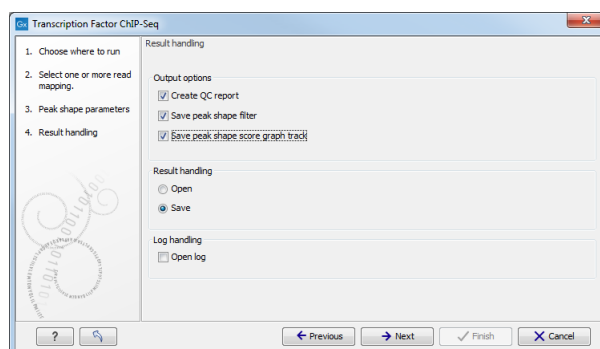



Figure 29.7: Output options for the Transcription Factor ChIP-Seq tool.

In addition to the annotation track with **Peak annotations** (📊) that will always be generated by the algorithm, you can choose to select additional output types.

The options are:

- **QC report** (📄) Generates a quality control report that allows you to check the quality of the reads. The QC report contains metrics about the quality of the ChIP-Seq experiment.

It lists the number of mapped reads, the normalized strand coefficient, and the relative strand correlation for each mapping. For each metric, the **Status** column will be **OK** if the experiment has good quality or **Low** if the metric is not as high as expected. Furthermore, the QC report will show the mean read length, the inferred fragment length, and the window size that the algorithm would need to be able to model the signal shape. In case the input contains paired-end reads, the report will also contain the empirical fragment length distribution. The metrics and their definitions are described in more detail in section 29.1.1.

- **Peak shape filter**  The peak shape filter contains the Hotelling Observer filter that was learned by the Transcription Factor ChIP-Seq algorithm. For the definition of Peak shape, see section 29.1.3.
- **Peak shape score**  A graph track containing the peak shape score. The track shows the peak shape score for each genomic position. To save disk space, only peak shape scores greater than zero are reported. For the definition of peak shape score, see section 29.1.3.

Choose whether you want to open the results directly, or save the results in the **Navigation Area**. If you choose to save the results, you will be asked to specify where you would like to save them.

Peak track

The main result of the Transcription Factor ChIP-Seq algorithm is an annotation track containing the peaks. For each peak the following quantities are reported in the table, which can be opened by clicking on the table icon  in the lower left corner of the peak annotation track:

- **Chromosome** The chromosome where the peak is located.
- **Region** The position of the peak.
- **Center of peak** The center position of the peak. This is determined as the genomic position that matches the peak shape filter best (see section 29.1.3).
- **Length** The length of the peak.
- **Peak shape score** The peak shape score of the peak (see section 29.1.3).
- **P-value** The p-value of the peak (see section 29.1.3).

The peak annotation track is most informative when combined with the read mapping in a Track List (you can see how to create a track list here: http://resources.qiagenbioinformatics.com/manuals/clcgenomicsworkbench/current/index.php?manual=Track_lists.html). A Track List containing the mapped reads, the Peak track, and the Peak shape score track is shown in figure 29.8.

Note that if you make a split view of the table and the peak annotation track (by holding down the Ctrl key (Cmd on Mac) while clicking on the table icon  in the lower left corner of the peak annotation track), you will be able to browse through the peaks by clicking in the table, as the peak annotation track and the table are connected. As a result the view will jump to the position of the peak selected in the table.

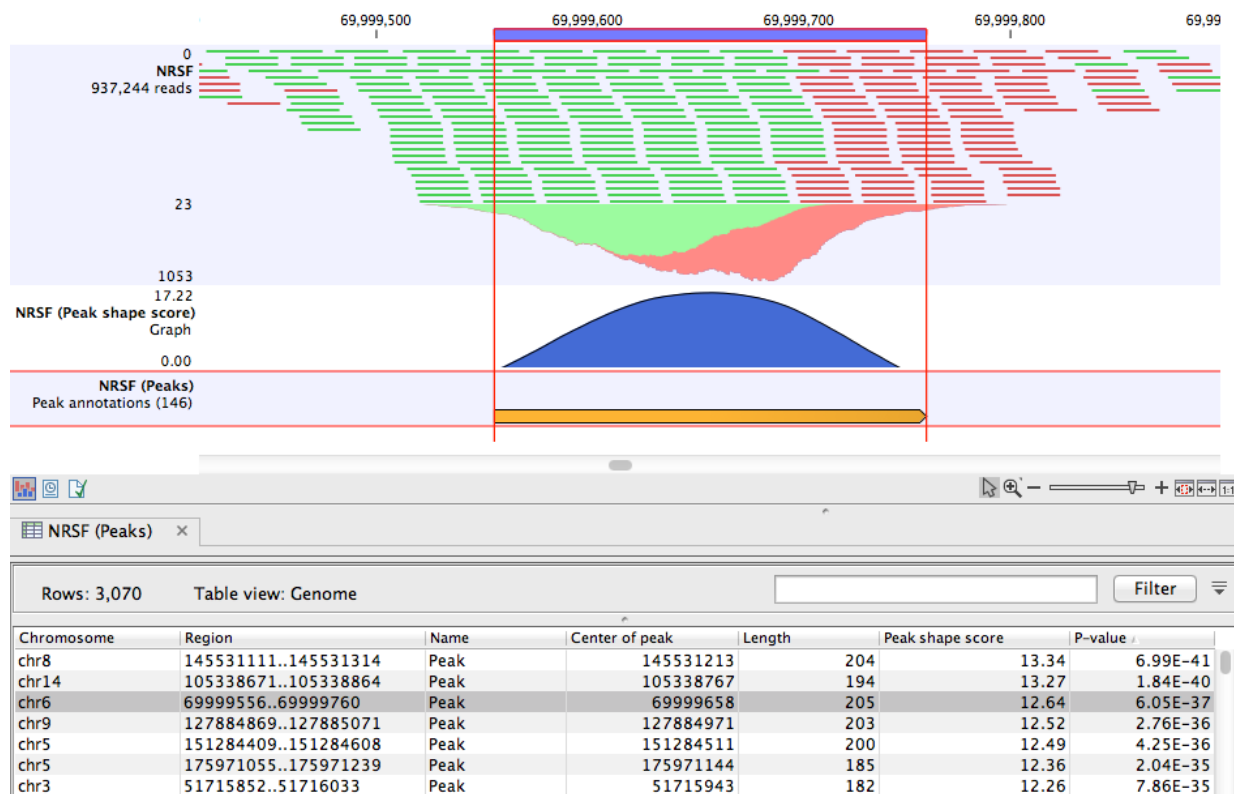

Figure 29.8: Inspection of the result of the Transcription Factor ChIP-Seq tool.

29.2 Annotate with nearby gene information

This tool will create a copy of the annotation track (📄) used as input and add information about nearby genes.

Toolbox | Epigenomics Analysis (📄) | Annotate with Nearby Gene Information (📄)

First, select the track you wish to annotate and click **Next**. The tool was designed for ChIP-Seq analysis, but you can choose any kind of annotation track as input. Next, select a gene track with a compatible genome (figure 29.9).

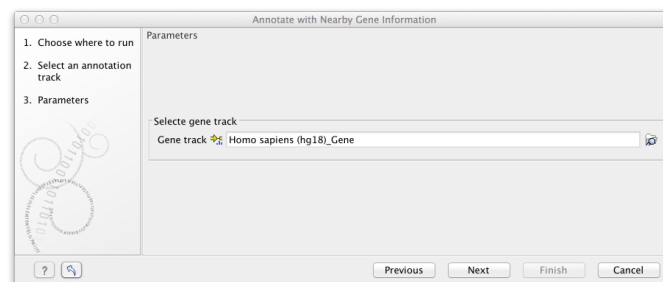

Figure 29.9: Select gene track.

The result of this tool is a new annotation track with all the annotations from the input track and with additional information about nearby genes and four columns will be added to the table view:

- **5' gene** The name of the nearest upstream gene.

- **5' distance** The distance from the nearest upstream gene or 0 if the feature overlaps the nearest gene. The distance value is determined by the shortest distance between an end of the gene annotation and an end of the peak annotation, regardless of the annotation orientation (see figure 29.10).
- **3' gene** The name of the nearest downstream gene.
- **3' distance** The distance from the nearest downstream gene or 0 if the feature overlaps the nearest downstream gene. The distance value is determined by the shortest distance between an end of the gene annotation and an end of the peak annotation, regardless of the annotation orientation.

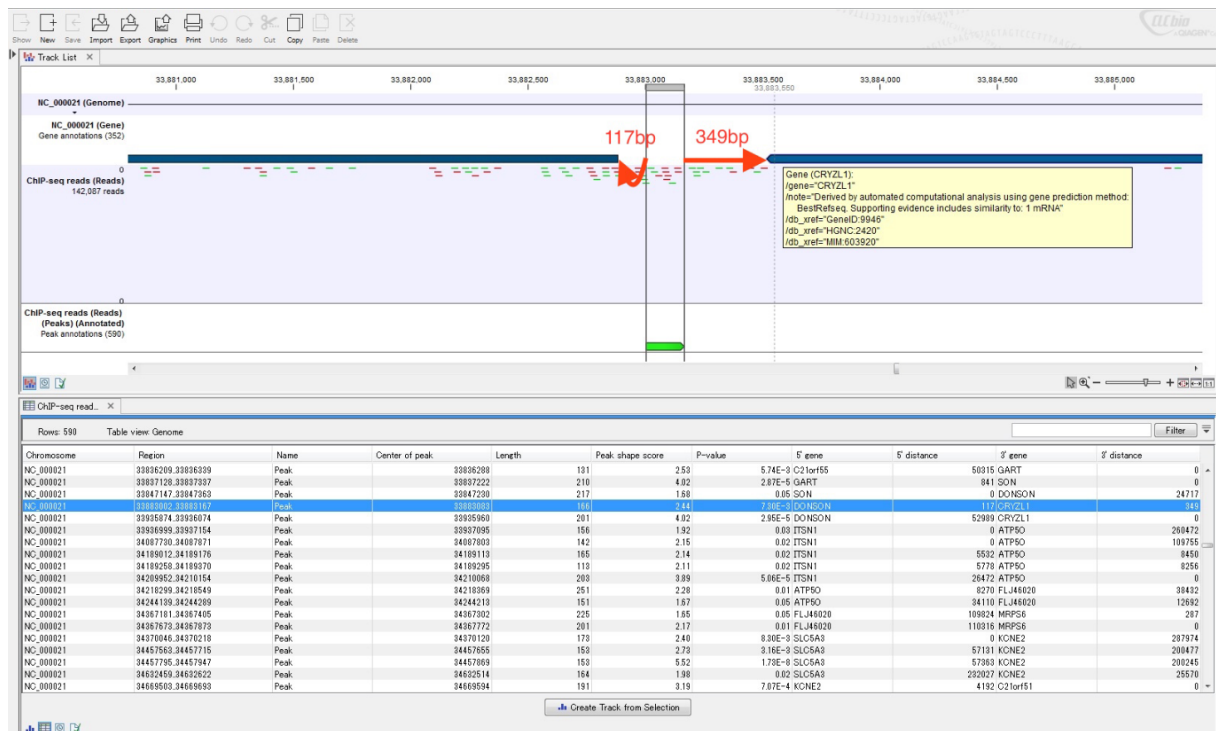

Figure 29.10: The figure is a split view between a table view and a track list showing the gene annotation track, the ChIP-Seq reads, and the annotated ChIP peaks. The red arrows and numbers illustrate the 5' distance and 3' distance.

Part V

Appendix

Appendix A

Use of multi-core computers

Many tools in CLC Workbenches and Servers can make use of multi-core CPUs. This does not necessarily mean that all available CPU cores are used throughout the analysis. It means that these tools benefit from running on computers with multiple CPU cores.

Tools available differ between CLC Workbenches. In the table, the availability of these tools in different CLC Workbench Toolbox menus is indicated with an X.

Use of multi-core computers	Genomics	Drug Discovery	Biomedical Genomics
Add Conservation Scores			X
Add Information about Amino Acid Changes			X
Add Information from Variants			X
Add Exon Number			X
Add Flanking Sequence			X
QC for Read Mapping			X
Amino Acid Changes	X		
Annotate and Merge Counts	X		X
Annotate from Known Variants	X		
Annotate with Conservation Score	X		
Annotate with Exon Numbers	X		
Annotate with Flanking Sequences	X		
Basic Variant Detection	X		X
BLAST (will not scale well on many cores)	X		
Compare Sample Variant Tracks	X		
Copy Number Variant Detection			X
Create Alignment	X	X	X
Create Detailed Mapping Report	X		
Create Sequencing QC Report	X		
Create Statistics for Target Regions	X		
De Novo Assembly	X		
Dock Ligands		X	
Download Reference Genome Data	X		
Extract and Count	X		X
Filter against Control Reads	X		
Filter against Known Variants	X		
Filter Marginal Variant Calls	X		
Filter Reference Variants	X		
Fisher Exact Test	X		
Fixed Ploidy Variant Detection	X		X
GO Enrichment Analysis	X		
Identify Enriched Variants in Case vs Control Group			X
Identify Highly Mutated Gene Groups and Pathways			X
Identify Variants with Effect on Splicing			X
Import Molecules from SMILES or 2D		X	
InDels and Structural Variants	X		X
K-mer Based Tree Construction	X		
Link Variants to 3D Protein Structure	X		X
Local Realignment	X		X
Low Frequency Variant Detection	X		X
Map Reads to Contigs	X		
Map Reads to Reference	X		X
Maximum Likelihood Phylogeny	X		
Merge Annotation Tracks	X		
Model Testing	X		
Predict Splice Site Effect	X		

Use of multi-core computers	Genomics	Drug Discovery	Biomedical Genomics
Probabilistic Variant Detection (legacy)	X		X
QC for Sequencing Reads			X
QC for Read Mapping			X
QC for Targeted Sequencing			X
Quality-based Variant Detection (legacy)	X		X
Remove False Positives			X
Remove Germline Variants			X
Remove Reference Variants			X
Remove Variants Found in Common dbSNP			X
Remove Variants Found in External Database			X
Remove Variants Found in HapMap			X
Remove Variants Found in 1000 Genomes Project			X
Remove Variants Inside Genome Regions			X
Remove Variants Not Found in External Database			X
Remove Variants Outside Genome Regions			X
Remove Variants Outside Targeted Regions			X
RNA-Seq Analysis	X		X
Screen Ligands		X	
Trim Sequences	X		X
Trio Analysis	X		X

Please note that a static license has a limitation on the maximum number of cores, see section [1.3.1](#).

Appendix B

Graph preferences

This section explains the view settings of graphs. The **Graph preferences** at the top of the **Side Panel** includes the following settings:

- **Lock axes** This will always show the axes even though the plot is zoomed to a detailed level.
- **Frame** Shows a frame around the graph.
- **Show legends** Shows the data legends.
- **Tick type** Determine whether tick lines should be shown outside or inside the frame.
 - Outside
 - Inside
- **Tick lines at** Choosing Major ticks will show a grid behind the graph.
 - None
 - Major ticks
- **Horizontal axis range** Sets the range of the horizontal axis (x axis). Enter a value in **Min** and **Max**, and press Enter. This will update the view. If you wait a few seconds without pressing Enter, the view will also be updated.
- **Vertical axis range** Sets the range of the vertical axis (y axis). Enter a value in **Min** and **Max**, and press Enter. This will update the view. If you wait a few seconds without pressing Enter, the view will also be updated.
- **X-axis at zero.** This will draw the x axis at $y = 0$. Note that the axis range will not be changed.
- **Y-axis at zero.** This will draw the y axis at $x = 0$. Note that the axis range will not be changed.
- **Show as histogram.** For some data-series it is possible to see the graph as a histogram rather than a line plot.

The **Lines and plots** below contains the following settings:

- **Dot type**

- None
- Cross
- Plus
- Square
- Diamond
- Circle
- Triangle
- Reverse triangle
- Dot

- **Dot color.** Allows you to choose between many different colors. Click the color box to select a color.

- **Line width**

- Thin
- Medium
- Wide

- **Line type**

- None
- Line
- Long dash
- Short dash

- **Line color.** Allows you to choose between many different colors. Click the color box to select a color.

For graphs with multiple data series, you can select which curve the dot and line preferences should apply to. This setting is at the top of the **Side Panel** group.

Note that the graph title and the axes titles can be edited simply by clicking with the mouse. These changes will be saved when you **Save** (☒) the graph - whereas the changes in the **Side Panel** need to be saved explicitly (see section 4.6).

Appendix C

BLAST databases

Several databases are available at NCBI, which can be selected to narrow down the possible BLAST hits.

C.1 Peptide sequence databases

- **nr.** Non-redundant GenBank CDS translations + PDB + SwissProt + PIR + PRF, excluding those in env_nr.
- **refseq.** Protein sequences from NCBI Reference Sequence project <http://www.ncbi.nlm.nih.gov/RefSeq/>.
- **swissprot.** Last major release of the SWISS-PROT protein sequence database (no incremental updates).
- **pat.** Proteins from the Patent division of GenBank.
- **pdb.** Sequences derived from the 3-dimensional structure records from the Protein Data Bank <http://www.rcsb.org/pdb/>.
- **env_nr.** Non-redundant CDS translations from env_nt entries.
- **month.** All new or revised GenBank CDS translations + PDB + SwissProt + PIR + PRF released in the last 30 days..

C.2 Nucleotide sequence databases

- **nr.** All GenBank + EMBL + DDBJ + PDB sequences (but no EST, STS, GSS, or phase 0, 1 or 2 HTGS sequences). No longer "non-redundant" due to computational cost.
- **refseq_rna.** mRNA sequences from NCBI Reference Sequence Project.
- **refseq_genomic.** Genomic sequences from NCBI Reference Sequence Project.
- **est.** Database of GenBank + EMBL + DDBJ sequences from EST division.
- **est_human.** Human subset of est.

- **est_mouse.** Mouse subset of est.
- **est_others.** Subset of est other than human or mouse.
- **gss.** Genome Survey Sequence, includes single-pass genomic data, exon-trapped sequences, and Alu PCR sequences.
- **htgs.** Unfinished High Throughput Genomic Sequences: phases 0, 1 and 2. Finished, phase 3 HTG sequences are in nr.
- **pat.** Nucleotides from the Patent division of GenBank.
- **pdb.** Sequences derived from the 3-dimensional structure records from Protein Data Bank. They are NOT the coding sequences for the corresponding proteins found in the same PDB record.
- **month.** All new or revised GenBank+EMBL+DDBJ+PDB sequences released in the last 30 days.
- **alu.** Select Alu repeats from REPBASE, suitable for masking Alu repeats from query sequences. See "Alu alert" by Claverie and Makalowski, Nature 371: 752 (1994).
- **dbsts.** Database of Sequence Tag Site entries from the STS division of GenBank + EMBL + DDBJ.
- **chromosome.** Complete genomes and complete chromosomes from the NCBI Reference Sequence project. It overlaps with refseq_genomic.
- **wgs.** Assemblies of Whole Genome Shotgun sequences.
- **env_nt.** Sequences from environmental samples, such as uncultured bacterial samples isolated from soil or marine samples. The largest single source is Sagarssso Sea project. This does overlap with nucleotide nr.

C.3 Adding more databases

Besides the databases that are part of the default configuration, you can add more databases located at NCBI by configuring files in the Workbench installation directory.

The list of databases that can be added is here: https://web.archive.org/web/20120409025527/http://www.ncbi.nlm.nih.gov/staff/tao/URLAPI/remote_blastdblist.html.

In order to add a new database, find the `settings` folder in the Workbench installation directory (e.g. `C:\Program files\CLC Genomics Workbench 4`). Download unzip and place the following files in this directory to replace the built-in list of databases:

- Nucleotide databases: http://www.resources.qiagenbioinformatics.com/wbsettings/NCBI_BlastNucleotideDatabases.zip
- Protein databases: http://www.resources.qiagenbioinformatics.com/wbsettings/NCBI_BlastProteinDatabases.zip

Open the file you have downloaded into the `settings` folder, e.g. `NCBI_BlastProteinDatabases.proper` in a text editor and you will see the contents look like this:

```
nr[clcddefault] = Non-redundant protein sequences
refseq_protein = Reference proteins
swissprot = Swiss-Prot protein sequences
pat = Patented protein sequences
pdb = Protein Data Bank proteins
env_nr = Environmental samples
month = New or revised GenBank sequences
```

Simply add another database as a new line with the first item being the database name taken from https://web.archive.org/web/20120409025527/http://www.ncbi.nlm.nih.gov/staff/tao/URLAPI/remote_blastdblist.html and the second part is the name to display in the Workbench. Restart the Workbench, and the new database will be visible in the BLAST dialog.

Appendix D

Proteolytic cleavage enzymes

Most proteolytic enzymes cleave at distinct patterns. Below is a compiled list of proteolytic enzymes used in *CLC Genomics Workbench*.

Name	P4	P3	P2	P1	P1'	P2'
Cyanogen bromide (CNBr)	-	-	-	M	-	-
Asp-N endopeptidase	-	-	-	-	D	-
Arg-C	-	-	-	R	-	-
Lys-C	-	-	-	K	-	-
Trypsin	-	-	-	K, R	not P	-
Trypsin	-	-	W	K	P	-
Trypsin	-	-	M	R	P	-
Trypsin*	-	-	C, D	K	D	-
Trypsin*	-	-	C	K	H, Y	-
Trypsin*	-	-	C	R	K	-
Trypsin*	-	-	R	R	H,R	-
Chymotrypsin-high spec.	-	-	-	F, Y	not P	-
Chymotrypsin-high spec.	-	-	-	W	not M, P	-
Chymotrypsin-low spec.	-	-	-	F, L, Y	not P	-
Chymotrypsin-low spec.	-	-	-	W	not M, P	-
Chymotrypsin-low spec.	-	-	-	M	not P, Y	-
Chymotrypsin-low spec.	-	-	-	H	not D, M, P, W	-
o-Iodosobenzoate	-	-	-	W	-	-
Thermolysin	-	-	-	not D, E	A, F, I, L, M or V	-
Post-Pro	-	-	H, K, R	P	not P	-
Glu-C	-	-	-	E	-	-
Asp-N	-	-	-	-	D	-
Proteinase K	-	-	-	A, E, F, I, L, T, V, W, Y	-	-
Factor Xa	A, F, G, I, L, T, V, M	D,E	G	R	-	-
Granzyme B	I	E	P	D	-	-
Thrombin	-	-	G	R	G	-
Thrombin	A, F, G, I, L, T, V, M	A, F, G, I, L, T, V, W, A	P	R	not D, E	not D, E
TEV (Tobacco Etch Virus)	-	Y	-	Q	G, S	-

Appendix E

Restriction enzymes database configuration

CLC Genomics Workbench uses enzymes from the **REBASE** restriction enzyme database at <http://rebase.neb.com>. If you wish to add enzymes to this list, you can do this by manually using the procedure described here.

Note! Please be aware that this process needs to be handled carefully, otherwise you may have to re-install the Workbench to get it to work.

First, download the following file: http://www.resources.qiagenbioinformatics.com/wbsettings/link_emboss_e_custom. In the Workbench installation folder under settings, create a folder named `rebase` and place the extracted `link_emboss_e_custom` file here.

Note that in MAC OS X, the extension file "link_emboss_e_custom" will have a ".txt" extension in its filename and metadata that needs to be removed. Right click the file name, choose "Get info" and remove ".txt" from the "Name & extension" field.

Open the file in a text editor. The top of the file contains information about the format, and at the bottom there are two example enzymes that you should replace with your own.

Please note that the CLC Workbenches only support the addition of 2-cutter enzymes. Further details about how to format your entries accordingly are given within the file mentioned above.

After adding the above file, or making changes to it, you must restart the Workbench for changes take effect.

Appendix F

Technical information about modifying Gateway cloning sites

The *CLC Genomics Workbench* comes with a pre-defined list of Gateway recombination sites. These sites and the recombination logics can be modified by downloading and editing a properties file. Note that this is a technical procedure only needed if the built-in functionality is not sufficient for your needs.

The properties file can be downloaded from <http://www.resources.qiagenbioinformatics.com/wbsettings/gatewaycloning.zip>. Extract the file included in the zip archive and save it in the `settings` folder of the Workbench installation folder. The file you download contains the standard configuration. You should thus update the file to match your specific needs. See the comments in the file for more information.

The name of the properties file you download is `gatewaycloning.1.properties`. You can add several files with different configurations by giving them a different number, e.g. `gatewaycloning.2.properties` and so forth. When using the Gateway tools in the Workbench, you will be asked which configuration you want to use (see figure [F.1](#)).

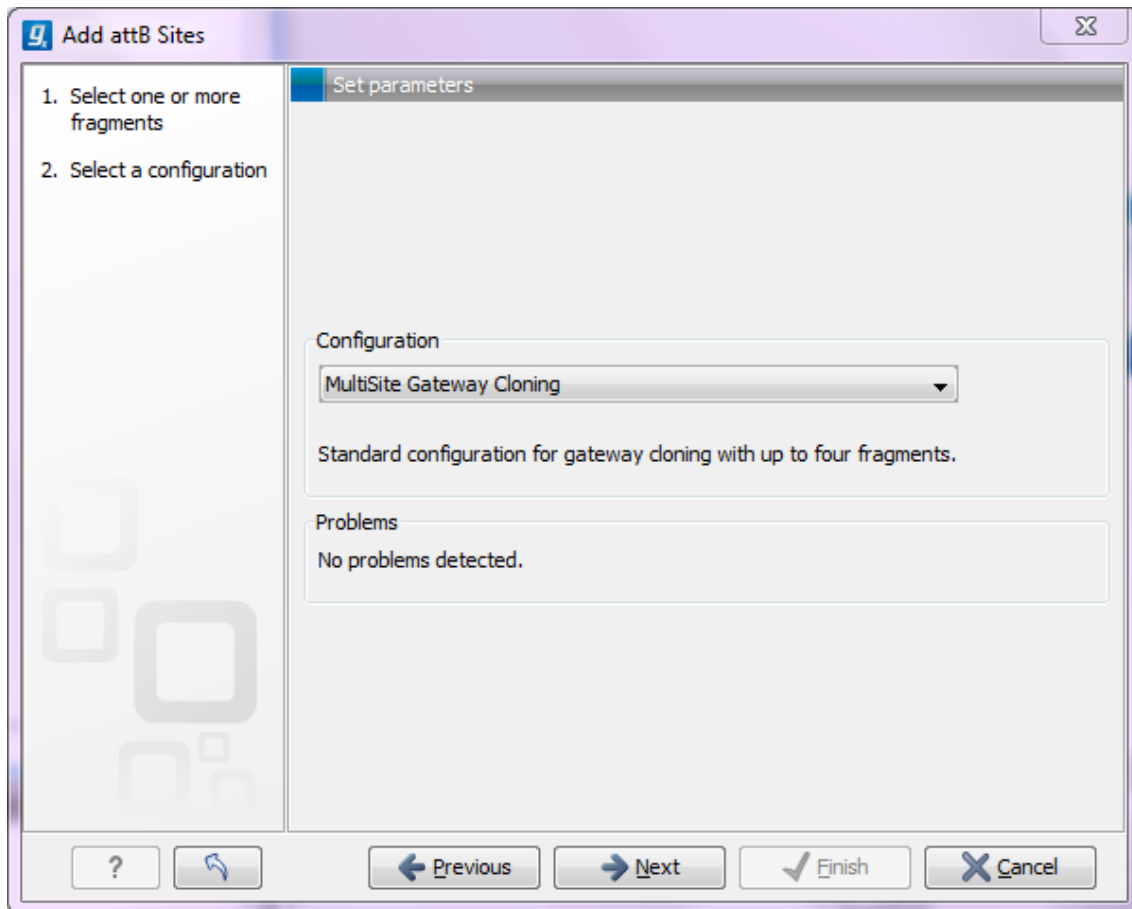

Figure F.1: Selecting between different gateway cloning configurations.

Appendix G

IUPAC codes for amino acids

(Single-letter codes based on International Union of Pure and Applied Chemistry)

The information is gathered from: http://www.insdc.org/documents/feature_table.html

One-letter abbreviation	Three-letter abbreviation	Description
A	Ala	Alanine
R	Arg	Arginine
N	Asn	Asparagine
D	Asp	Aspartic acid
C	Cys	Cysteine
Q	Gln	Glutamine
E	Glu	Glutamic acid
G	Gly	Glycine
H	His	Histidine
J	Xle	Leucine or Isoleucine
L	Leu	Leucine
I	Ile	Isoleucine
K	Lys	Lysine
M	Met	Methionine
F	Phe	Phenylalanine
P	Pro	Proline
O	Pyl	Pyrrolysine
U	Sec	Selenocysteine
S	Ser	Serine
T	Thr	Threonine
W	Trp	Tryptophan
Y	Tyr	Tyrosine
V	Val	Valine
B	Asx	Aspartic acid or Asparagine
Z	Glx	Glutamic acid or Glutamine
X	Xaa	Any amino acid

Appendix H

IUPAC codes for nucleotides

(Single-letter codes based on International Union of Pure and Applied Chemistry)

The information is gathered from: <http://www.iupac.org> and http://www.insdc.org/documents/feature_table.html.

Code	Description
A	Adenine
C	Cytosine
G	Guanine
T	Thymine
U	Uracil
R	Purine (A or G)
Y	Pyrimidine (C, T, or U)
M	C or A
K	T, U, or G
W	T, U, or A
S	C or G
B	C, T, U, or G (not A)
D	A, T, U, or G (not C)
H	A, T, U, or C (not G)
V	A, C, or G (not T, not U)
N	Any base (A, C, G, T, or U)

Appendix I

Formats for import and export

I.1 List of bioinformatic data formats

Below is a list of bioinformatic data formats, i.e. formats for importing and exporting molecule structures, sequences, alignments and trees.

I.1.1 Sequence data formats

Note that high-throughput sequencing data formats from Illumina, SOLiD, IonTorrent, 454 and also high-throughput fasta and trace files are imported using a special import as described in section 6.3. These data can also be exported in fastq format (using NCBI/Sanger Phred quality scores).

File type	Suffix	Import	Export	Description
AB1	.ab1	X		Including chromatograms
ABI	.abi	X		Including chromatograms
CLC	.clc	X	X	Rich format including all information
Clone manager	.cm5	X		Clone manager sequence format
DNAstrider	.str/.strider	X	X	
DS Gene	.bsml	X		
EMBL	.emb/.embl	X	X	Rich information incl. annotations (nucs only)
FASTA	.fsa/.fasta	X	X	Simple format, name & description
FASTQ	.fastq	X	X	Simple format, name & description
GCG sequence	.gcg	X	X	Rich information incl. annotations
GenBank	.gbk/.gb/.gp/.gbt	X	X	Rich information incl. annotations
Gene Construction Kit	.gcc	X		
Lasergene	.pro/.seq	X		
Nexus	.nxs/.nexus	X	X	
Phred	.phd	X		Including chromatograms
PIR (NBRF)	.pir	X	X	Simple format, name & description
Raw sequence	any	X		Only sequence (no name)
SCF2	.scf	X		Including chromatograms
SCF3	.scf	X	X	Including chromatograms
Sequence Comma separated values	.csv	X	X	Simple format. One seq per line: name, description(optional), sequence
Staden	.sdn	X		
Swiss-Prot	.swp	X	X	Rich information incl. annotations (only peptides)
Tab delimited text	.txt		X	Annotations in tab delimited text format
Vector NTI archives*	.ma4/.pa4/.oa4	X		Archives in rich format
Vector NTI Database*		X		Special import full database

*Vector NTI import functionality comes as standard within the CLC Main Workbench and can be installed as a plugin via the Plugins Manager of the CLC Genomics Workbench (read more in section 1.6.1).

When exporting in fasta format, it is possible to remove sequence ends covered by annotations of type "Trim" (read more in section 17.2).

I.1.2 Read mapping formats

File type	Suffix	Import	Export	Description
ACE	.ace	X	X	No chromatogram or quality score
AGP	.agp/.fa		X	Exports scaffolded contigs (see below)
BAM	.bam	X	X	Compressed version of SAM. See details in section 6.3.10
CLC	.clc	X	X	Rich format including all information
CLC Assembly File	.cas	X		Output from the CLC Assembly Cell
SAM	.sam	X	X	Sequence Alignment/Map. See details in section 6.3.10
Mapping coverage	.tsv		X	Detailed per-base info on coverage (see below)

Special note about AGP format Both sequence lists and contigs with reads mapped can be used. Based on annotations of type **Scaffold** (which are automatically added when running the *de novo* assembly with the scaffold option), the contigs are broken up before exported as fasta. The agp file produced holds information about how the contigs relate to each other.

Export of coverage information from sequence alignments Coverage information from read mappings can be exported in a tabular format using the **Mapping coverage** export. The output contains information on the number of nucleotides aligned to positions in reference sequences. Insertions are also reported as described below while deletions are reported as reference regions without read coverage. Both stand-alone read mappings and read tracks can be used as input.

The exported file contains the following columns:

Column	Description
1	Reference name
2	Reference position
3	Reference sub-position (insertion)
4	Reference symbol
5	Number of A's
6	Number of C's
7	Number of G's
8	Number of T's
9	Number of N's
10	Number of Gaps
11	Total number of reads covering the position

The **Reference sub-position** column is empty (indicated by a - symbol) when the reference is defined at a given position. In case of an insertion this column contains an index into the insertion (a number between 1 and the length of the insertion) while the **Reference symbol** column is empty and the **Reference position** column contains the position of the last reference.

I.1.3 Alignment formats

File type	Suffix	Import	Export	Description
Aligned fasta	.fa	X	X	Simple fasta-based format with – for gaps
CLC	.clc	X	X	Rich format including all information
ClustalW	.aln	X	X	
GCG Alignment	.msf	X	X	
Nexus	.nxs/.nexus	X	X	
Phylip Alignment	.phy	X	X	

I.1.4 Tree formats

File type	Suffix	Import	Export	Description
CLC	.clc	X	X	Rich format including all information
Newick	.nwk	X	X	
Nexus	.nxs/.nexus	X	X	

I.1.5 Expression data formats

Read about technical details of these data formats in section [K](#).

File type	Suffix	Import	Export	Description
Affymetrix CHP	.chp/.psi	X		Expression values and annotations
Affymetrix pivot/metric	.txt/.csv	X		Gene-level expression values
Affymetrix NetAffx	.csv	X		Annotations
CLC	.clc	X	X	Rich format including all information
Excel	.xls/.xlsx		X	All tables and reports
Generic	.txt/.csv	X		Expression values
Generic	.txt/.csv	X		Annotations
GEO soft sample/series	.txt/.csv	X		Expression values
Illumina	.txt	X		Expression values and annotations
Table CSV	.csv		X	Samples and experiments
Tab delimited	.txt		X	Samples and experiments

I.1.6 Annotation and variant formats

Please note that all of the annotation and variant formats can be imported as tracks (see section 6.2). GFF, GVF and GTF formats can also be imported as annotations on a standard (i.e., non-track) sequence or sequence list using functionality provided by the Annotate with GFF plugin (<http://www.qiagenbioinformatics.com/plugins/annotate-with-gff-file/>).

File type	Suffix	Import	Export	Description
Annotation CSV export	.csv		X	Annotations in csv format
Annotation 2010	.xlsx		X	Annotations in Excel format
Annotation Excel 97 - 2007	.xls		X	Annotations in Excel format
VCF	.vcf	X	X	See note below
GFF	.gff	X		To import as annotation track, see section 6.2.
GVF	.gvf	X	X	Special version of GFF for variant data. See GFF entry above.
GTF	.gtf	X	X	Special version of GFF for gene annotation data. See GFF entry above.
GFF3	.gff3	X	X	To import and export as annotation track, see section 6.2.1.
COSMIC database	variation .tsv	X		Special format for COSMIC data
BED	.bed	X	X	See section 6.2
Wiggle	.wig	X	X	See section 6.2
UCSC database dump	variant table .txt	X		See section 6.2
Complete master var files	genomics masterVar	X		Complete genomics variant data format

Special note on VCF export

For VCF export, counts from the variant track are put in CLCAD2 tags and coverage in DP tags. The values of the CLCAD2 tag follow the order of REF and ALT, with one value for the REF and for each ALT. For example if there has been a homozygote variant identified at a certain position, the value of the GT field is 1/1 and the corresponding CLCAD2 value for the reference allele will be 0, which is always the first number in the CLCAD2 field. Please note that this does not mean the original *mapping* did not have any reads with that sequence, but it means that the *variant track* being exported does not contain the reference allele.

When exporting VCF files, there are three options:

Reference sequence track Since the VCF format specifies that reference and allele sequences cannot be empty, deletions and insertions have to be padded with bases from the reference sequence. The export needs access to the reference sequence track in order to find the neighboring bases.

Enforce diploid export The *CLC Genomics Workbench* option will generate a VCF file in which the allele values in the Genotype (GT) field for haploid variants are reported following the

format for diploid variants (i.e. the GT allele values reported are 1/1). This is to ensure compatibility of the exported VCF file with programs for downstream variant analysis that expect strictly diploid genomes. The user can specify that the Enforce diploid option is only applied to certain chromosomes, while others may be reported as haploid. If you export a variant track that has been filtered, there can be situations where there is only one heterozygous variant at a given position. In this case, the *CLC Genomics Workbench* will use a "." to denote an unknown genotype, so the GT field will be "1/.".

Note: the "Enforce diploid" option does NOT enforce diploidy for polyploid variant loci. Regardless of this setting, all variant alleles reported during variant calling are included in the exported VCF file.

It is important to note that this **Enforce diploid export** option will create a diploid format of the VCF file, but it is not able to recover any inconsistencies in the variant track used as input. If the variant track has three variants at a given position, three genotypes will be output. Or if the variant track has two variants at the same position that both postulate to be homozygous, they will be output as two heterozygous variants. When exporting data created by the variant callers of *CLC Genomics Workbench*, this is usually not a problem, but when applying this diploid scheme to data that has been imported into the *CLC Genomics Workbench* from other sources, the data can be inconsistent with a diploid model.

Exceptions Some chromosomes can be excepted from the enforced diploid export. For a human genome, that would be relevant for the mitochondrion and for male X and Y chromosomes. For this option, you can select which chromosomes should be excepted. They will be exported in the standard way without assuming there should be two genotypes, and homozygous calls will just have one value in the GT field.

Special note on former VCF export

In *CLC Genomics Workbench* 6.5 instead of the CLCAD2, the CLCAD field had been reported. The difference between CLCAD and CLCAD2 is that the former is following the order in the GT (genotype) field in VCF, while the latter is following the order of the REF and ALT fields in VCF in is therefore more in line with the AD field reported from GATK and other sources.

Special notes on VCF import Note! Please also see section [6.2](#).

The import process for VCF files into the *CLC Genomics Workbench* currently work as follows:

1. For VCF rows that are reporting the reference base, no variants are imported.
2. In cases where GT = 0/0 or GT = ./., no variants are imported at all.
3. In cases where GT = X/. or GT = ./X , and where X is not zero, a single variant is imported depending on the actual value of X.
4. In cases where GT = X/X and X is not zero, in *Genomics Workbench* 6.5 this will result in two independent variants. In version 6.5.1 they will be reported as a single homozygous variant.
5. In cases where GT = X/Y and X and Y are different but either one may be zero, two independent variants are created.

Please note that some replacements cannot be interpreted in versions that are older than CLC Genomics Workbench 7.0; such replacements will therefore not be imported in previous versions of *CLC Genomics Workbench*.

An example of these types of replacements are the following:

```
chr2 32843292 . TTTA T,TTT 100 PASS DP=44
```

Due to the VCF interpretation, the initial T base is removed from all alternatives.

In version 6.5.x, only the reference allele (TTA -> TTA) and the first deletion in ALT (TTA -> -) will be imported. The replacements TTA -> TT will not be imported.

In version 7.0 and later versions, all variants will be imported, but the replacements TTA -> TT will be imported as one deletion A -> - .

To get a variant count as part of your imported variant, one of the following VCF tags have to be present in your VCF file: CLCAD2, AD, or AO.

The import of CLCAD2/AD/AO tags are prioritized in the following order:

1. CLCAD2
2. AD
3. AO

If the CLCAD2 is missing, and only AD is present, then AD is used in the "count" column.

The consequence of this, if the file for example has CLCAD2:AD, and in a sample for three possible variants the values are 2,3,4:5,6,7, then the CLCAD2 tag will be imported as count, so each of the three variants will have just one count value (2, 3, and 4 respectively). At the same time, the AD tag will be imported as an annotation so all of the three variants will have "5,6,7" under the AD column, like for any unknown format tag.

Special notes on chromosome names synonyms used during import

When importing annotations as tracks, we try to make things simple for the user by having a set of chromosome names that are recognized as synonyms. The check on the chromosome name comparison is made by looking through the chromosomes in the order in which they are registered in the genome. The first match with any of the synonym names for a given chromosome is the chromosome to which the information will be added.

The synonyms applied are:

For any number N between (including) 1 and 22:

N, chrN, chromosome_N, and NC_00000N are seen as meaning the same thing. As concrete examples:

```
1 == chr1 == chromosome_1 == NC_000001
```

```
22 == chr22 == chromosome_22 == NC_000022
```

For any number N larger than 23:

N, chrN, chromosome_N are seen as meaning the same thing. As a concrete example:

26 == chr26 == chromosome_26

For chromosome names with letters, not numbers:

X, chrX, and chromosome_X and NC_000023 are synonyms.

Y, chrY, chromosome_Y and NC_000024 are synonyms.

M, MT, chrM, chrMT, chromosome_M, chromosome_MT and NC_001807 are synonyms.

The accession numbers in the listings above (NC_XXXXXX) allow for the matching against NCBI hg19 human reference names against the names used by USCS and vitally, the names used by Ensembl. Thus, in this case, if you have the correct number of chromosomes in a human reference (i.e. 25 references, including the hg19 mitochondria), that set of tracks can be used as the basis for downloading/importing annotations via Download Genomes, for example.

Note: These rules only apply for importing annotations as tracks, whether that is directly or via Download Genomes. Synonyms are not applied when doing BAM imports or when using the Annotate with GFF plugin. There, your reference names in the Workbench must exactly match the references names used in your BAM file or GFF/GTF/GVF file respectively.

I.1.7 Other formats

File type	Suffix	Import	Export	Description
CLC	.clc	X	X	Rich format including all information
PDB	.pdb	X		3D structure
RNA structures	.ct, .col, .rnaml/.xml	x		Secondary structure for RNA

I.1.8 Table and text formats

File type	Suffix	Import	Export	Description
Excel	.xls/.xlsx	X	X	All tables and reports
Table CSV	.csv	X	X	All tables
Tab delimited	.txt		X	All tables
Text	.txt	X	X	All data in a textual format
CLC	.clc	X	X	Rich format including all information
HTML	.html		X	All tables
PDF	.pdf		X	Export reports in Portable Document Format

Please see table [I.1.5 Expression data formats](#) for special cases of table imports.

I.1.9 File compression formats

File type	Suffix	Import	Export	Description
Zip export	.zip		X	Selected files in CLC format
Zip import	.zip/.gz/.tar	X		Contained files/folder structure (.tar and .zip not supported for NGS data)

Note! It is possible to import 'external' files into the Workbench and view these in the **Navigation Area**, but it is only the above mentioned formats whose *contents* can be shown in the Workbench.

I.2 List of graphics data formats

Below is a list of formats for exporting graphics. All data displayed in a graphical format can be exported using these formats. Data represented in lists and tables can only be exported in .pdf format (see section 6.6 for further details).

Format	Suffix	Type
Portable Network Graphics	.png	bitmap
JPEG	.jpg	bitmap
Tagged Image File	.tif	bitmap
PostScript	.ps	vector graphics
Encapsulated PostScript	.eps	vector graphics
Portable Document Format	.pdf	vector graphics
Scalable Vector Graphics	.svg	vector graphics

Appendix J

SAM/BAM export format specification

SAM Specification The workbench aims to import and export SAM and BAM files according to the v1.4-r962 version of the SAM specification (see <http://samtools.sourceforge.net/SAM1.pdf>). This appendix describes how the workbench exports SAM and BAM files along with known limitations.

SAM and BAM Export - General notes The SAM exporter writes unsorted SAM and BAM files.

If the reference name contains spaces, the spaces are removed. Each occurrence of '=' (equals sign) and '@' (at sign) in a reference name is replaced by an '_' (underscore).

The SAM importer and exporter support the ID, SM, PI and PL read group tags. All other read group tags are ignored.

SAM Alignment Section A few remarks on the exported alignment section:

- Unmapped reads are not exported.
- If pairs are not on the same contig, the mates will be exported as single reads.
- Multi segment mappings will be imported as a paired data set.
- If a read name contains spaces, the spaces are replaced by an underscore '_'.
- The exported CIGAR string uses 'M' to indicate match or mismatch and does not use '=' (equals sign) or 'X'.
- CLC software does not support or record mapping quality for read mappings. To fulfill the requirement in the BAM format specifications that a read mapping quality is recorded for all mapped reads, the values 0 and 60 are used when mappings are exported from the Workbench. The value 60 is given to reads that mapped uniquely. The value 0 is given to reads that could map equally well to other locations besides the one being reported in the BAM file.

This scoring system is based on a recommendation provided in the SAM FAQ:

http://sourceforge.net/apps/mediawiki/samtools/index.php?title=SAM_FAQ#How_to_make_my_aligner_work_best_with_samtools.3F

Optional fields in the alignment section The following is true for the export of optional fields:

- The NH tag is exported.
- The NM tag is not exported.
- The workbench exports color space information in the CS tag.
- The colors of a right mate are incorrect since the colors of a paired read are stored as a single color string.
- For hard clipped sequence reads, the color space is incorrect, since the color space string is not hard clipped.
- SAM files contain sequence quality score and color quality scores. The workbench only have color quality scores and these are stored and exported as sequence quality scores.

J.1 Flags

The workbench's use of the alignment flags is shown in the following table and subsequent examples.

Bit	SAM description	Usage in Workbench
0x1	template having multiple segments in sequencing	set if the segment is part of a pair
0x2	each segment properly aligned according to the aligner	set if the pair is not broken
0x4	segment unmapped	never set since the exporter does not export unmapped reads
0x8	next segment in the template unmapped	never set by the exporter. If a segment has an unmapped mate, the flag 0x1 is not set for the segment, i.e. it is not output as part of a pair
0x10	SEQ being reverse complemented	set if and only if the segment was reverse complemented during mapping
0x20	SEQ of the next segment in the template being reversed	set if and only if the mate was reverse complemented during mapping
0x40	the first segment in the template	this mate is the first segment of the pair
0x80	the last segment in the template	this mate is the second segment of the pair
0x100	secondary alignment	never set by the exporter. No reads with this flag set are imported ¹ .
0x200	not passing quality controls	never set by the exporter and ignored by the importer
0x400	PCR or optical duplicate	never set by the exporter and ignored by the importer

Flag Examples

The following table illustrates some of the possible flags in the workbench.

Description of the example	Bits	Flag	Illustration
The first mate of a non-broken paired read	0x1, 0x2, 0x20, 0x40	99	See Figure J.1
The second mate of a non-broken paired read	0x1, 0x2, 0x10, 0x80	147	See Figure J.2
A single, forward read (or paired read, where only one mate of the pair is mapped)	No set bits	0	see Figure J.3
A single, reversed read (or paired read, where only one mate of the pair is mapped)	0x10	16	See Figure J.4
The first, forward segment from a broken pair with forward mate	0x1, 0x40	65	See Figure J.5
The second, forward segment from broken pair with reversed mate	0x1, 0x20, 0x80	161	See Figure J.6
The first, reversed segment from broken pair with forward mate	0x1, 0x10, 0x40	81	See Figure J.7
The second, reversed segment from broken pair with reversed mate	0x1, 0x10, 0x20, 0x80	177	See Figure J.8

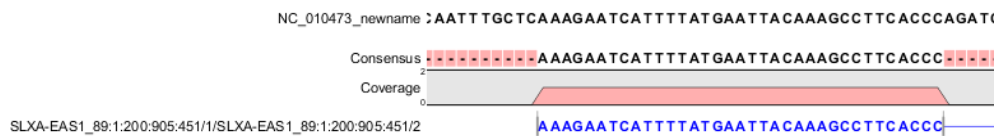

Figure J.1: The read is paired, both reads are mapped and the mate of this read is reversed

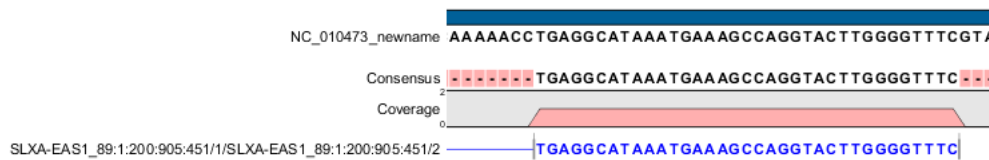

Figure J.2: The read is paired, both mates are mapped, and this segment is reversed

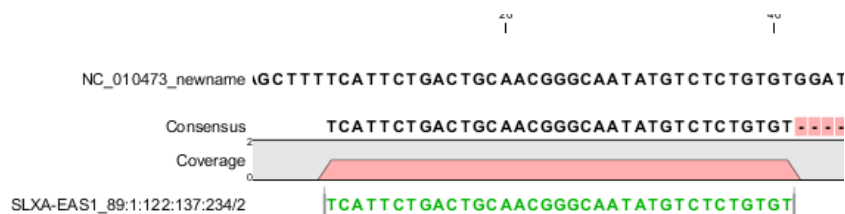

Figure J.3: A single, forward read, or a paired read where the mate is not mapped

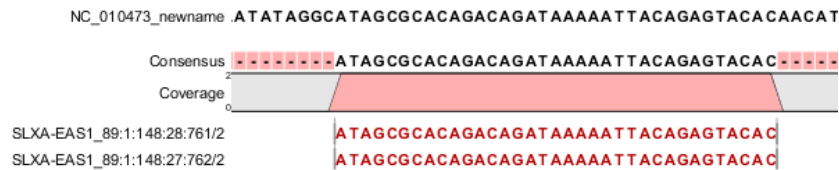

Figure J.4: The read is a single, reversed read, or a paired read where the mate is not mapped

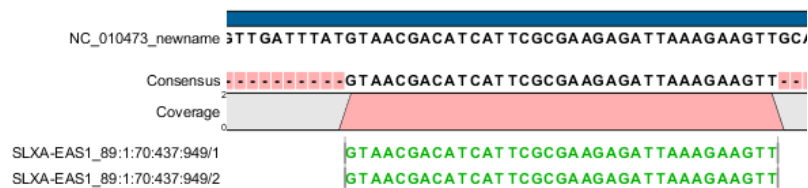

Figure J.5: These forward reads are paired. They map to the same place, so the pair is broken

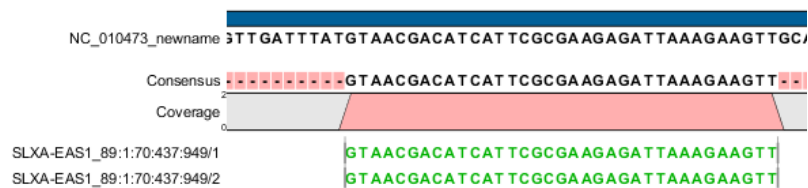

Figure J.6: Forward read that is part of a broken read where the mate is reversed

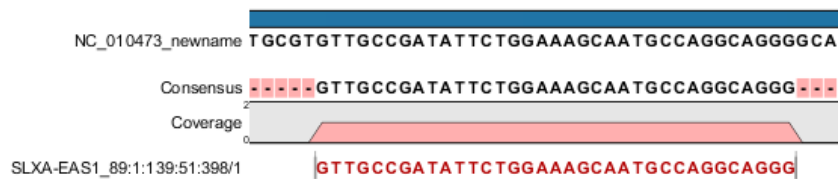

Figure J.7: Reversed read that is part of a broken pair, where the mate is forward

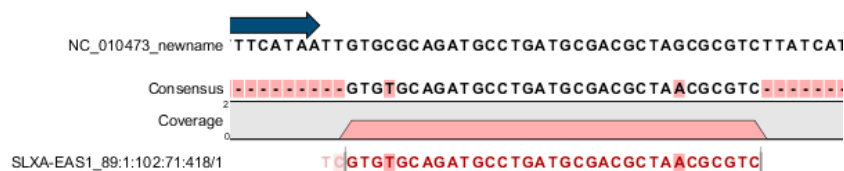

Figure J.8: Reversed read that is part of a broken pair, where the mate is also reversed.

Appendix K

Gene expression annotation files and microarray data formats

The workbench supports analysis of one-color expression arrays. These may be imported from GEO soft sample- or series- file formats, or for Affymetrix arrays, tab-delimited pivot or metrics files, or from Illumina expression files. Expression array data from other platforms may be imported from tab, semi-colon or comma separated files containing the expression feature IDs and levels in a tabular format (see section [K.5](#)).

The workbench assumes that expression values are given at the gene level, thus probe-level analysis of e.g. Affymetrix GeneChips and import of Affymetrix CEL and CDF files is currently not supported. However, the workbench allows import of txt files exported from R containing processed Affymetrix CEL-file data (see section [K.2](#)).

Affymetrix NetAffx annotation files for expression GeneChips in csv format and Illumina annotation files can also be imported. Also, you may import your own annotation data in tabular format see section [K.5](#)).

Below you find descriptions of the microarray data formats that are supported by *CLC Genomics Workbench*. Note that we for some platforms support both expression data and annotation data.

K.1 GEO (Gene Expression Omnibus)

The GEO (Gene Expression Omnibus) sample and series formats are supported. Figure [K.1](#) shows how to download the data from GEO in the right format. GEO is located at <http://www.ncbi.nlm.nih.gov/geo/>.

The GEO sample files are tab-delimited .txt files. They have three required lines:

```
^SAMPLE = GSM21610
!sample_table_begin
...
!sample_table_end
```

The first line should start with ^SAMPLE = followed by the sample name, the line !sample_table_begin and the line !sample_table_end. Between the !sample_table_begin and !sample_table_end,

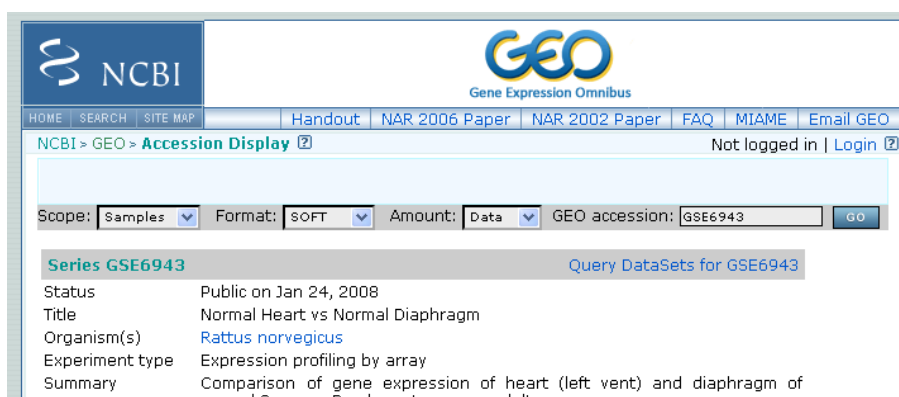

Figure K.1: Selecting Samples, SOFT and Data before clicking go will give you the format supported by the **CLC Genomics Workbench**.

lines are the column contents of the sample.

Note that GEO sample importer will also work for concatenated GEO sample files – allowing multiple samples to be imported in one go. Download a sample file containing concatenated sample files here:

<http://www.resources.qiagenbioinformatics.com/madata/GEOSampleFilesConcatenated.txt>

Below you can find examples of the formatting of the GEO formats.

K.1.1 GEO sample file, simple

This format is very simple and includes two columns: one for feature id (e.g. gene name) and one for the expression value.

```
^SAMPLE = GSM21610
!sample_table_begin
ID_REF    VALUE
id1       105.8
id2       32
id3       50.4
id4       57.8
id5       2914.1
!sample_table_end
```

Download the sample file here:

<http://www.resources.qiagenbioinformatics.com/madata/GEOSampleFileSimple.txt>

K.1.2 GEO sample file, including present/absent calls

This format includes an extra column for absent/present calls that can also be imported.

```
^SAMPLE = GSM21610
!sample_table_begin
```

```
ID_REF    VALUE    ABS_CALL
id1       105.8    M
id2       32       A
id3       50.4     A
id4       57.8     A
id5       2914.1   P
!sample_table_end
```

Download the sample file here:

<http://www.resources.qiagenbioinformatics.com/madata/GEOSampleFileAbsentPresent.txt>

K.1.3 GEO sample file, including present/absent calls and p-values

This format includes two extra columns: one for absent/present calls and one for absent/present call p-values, that can also be imported.

```
^SAMPLE = GSM21610
!sample_table_begin
ID_REF    VALUE    ABS_CALL    DETECTION P-VALUE
id1       105.8    M           0.00227496
id2       32       A           0.354441
id3       50.4     A           0.904352
id4       57.8     A           0.937071
id5       2914.1   P           6.02111e-05
!sample_table_end
```

Download the sample file here:

<http://www.resources.qiagenbioinformatics.com/madata/GEOSampleFileAbsentPresent.txt>

K.1.4 GEO sample file: using absent/present call and p-value columns for sequence information

The workbench assumes that if there is a third column in the GEO sample file then it contains present/absent calls and that if there is a fourth column then it contains p-values for these calls. This means that the contents of the third column is assumed to be text and that of the fourth column a number. As long as these two basic requirements are met, the sample should be recognized and interpreted correctly.

You can thus use these two columns to carry additional information on your probes. The absent/present column can be used to carry additional information like e.g. sequence tags as shown below:

```
^SAMPLE = GSM21610
!sample_table_begin
ID_REF    VALUE    ABS_CALL
id1       105.8    AAA
```

```
id2      32      AAC
id3      50.4    ATA
id4      57.8    ATT
id5      2914.1  TTA
!sample_table_end
```

Download the sample file here:

<http://www.resources.qiagenbioinformatics.com/madata/GEOSampleFileSimpleSequence.txt>

Or, if you have multiple probes per sequence you could use the present/absent column to hold the sequence name and the p-value column to hold the interrogation position of your probes:

```
^SAMPLE = GSM21610
!sample_table_begin
ID_REF      VALUE      ABS_CALL      DETECTION P-VALUE
probe1      755.07     seq1          1452
probe2      587.88     seq1          497
probe3      716.29     seq1          1447
probe4      1287.18    seq2          1899
!sample_table_end
```

Download the sample file here:

<http://www.resources.qiagenbioinformatics.com/madata/GEOSampleFileSimpleSequence.txt>

K.1.5 GEO series file, simple

The series file includes expression values for multiple samples. Each of the samples in the file will be represented by its own element with the sample name. The first row lists the sample names.

```
!Series_title "Myb specificity determinants"
!series_matrix_table_begin
"ID_REF" "GSM21610" "GSM21611" "GSM21612"
"id1"    2541      1781.8     1804.8
"id2"    11.3      621.5      50.2
"id3"    61.2      149.1      22
"id4"    55.3      328.8      97.2
"id5"    183.8     378.3      423.2
!series_matrix_table_end
```

Download the sample file here:

<http://www.resources.qiagenbioinformatics.com/madata/GEOSeriesFile.txt>

K.2 Affymetrix GeneChip

For Affymetrix, three types of files are currently supported: Affymetrix .CHP files, Affymetrix NetAffx annotation files and tab-delimited pivot or metrics files. Affymetrix .CEL files are currently not

supported. However, the Bioconductor R package 'affy' allows you to preprocess the .CEL files and export a txt file containing a table of estimated gene-level expression values in three lines of code:

```
library(affy) # loading Bioconductor library 'affy'
data=ReadAffy() # probe-level data import
eset=rma(data) # probe-level data pre-processing using 'rma'
write.exprs(eset,file="evals.txt") # writing gene expression levels to 'evals-txt'
```

The exported txt file (evals.txt) can be imported into the workbench using the Generic expression data table format importer (see section K.5; you can just 'drag-and-drop' it in). In R, you should have all the CEL files you wish to process in your working directory and the file 'evals.txt' will be written to that directory.

K.2.1 Affymetrix CHP expression files

The Affymetrix scanner software produces a number of files when a GeneChip is scanned. Two of these are the .CHP and the .CEL files. These are binary files with native Affymetrix formats. The Affymetrix GeneChips contain a number of probes for each gene (typically between 22 and 40). The .CEL file contains the probe-level intensities, and the .CHP file contains the gene-level information. The gene-level information has been obtained by the scanner software through postprocessing and summarization of the probe-level intensities.

In order to interpret the probe-level information in the .CEL file, the .CDF file for the type of GeneChip that was used is required. Similarly for the .CHP file: in order to interpret the gene-level information in the .CHP file, the .PSI file for the type of GeneChip that was used is required.

In order to import a .CHP file it is required that the corresponding .PSI file is present in the same folder as the .CHP file you want to import, and furthermore, this must be the only .PSI file that is present there. There are no requirements for the name of the .PSI file. Note that the .PSI file itself will not be imported - it is only used to guide the import of the .CHP file which contains the expression values.

Download example .CHP and .PSI files here (note that these are binary files):

<http://www.resources.qiagenbioinformatics.com/madata/AffymetrixCHPandPSI.zip>

K.2.2 Affymetrix metrix files

The Affymetrix metrics or pivot files are tab-delimited files that may be exported from the Affymetrix scanner software. The metrics files have a lot of technical information that is only partly used in the Workbench. The feature ids (Probe Set Name), expression values (Used Signal), absent/present call (Detection) and absent/present p-value (Detection p-value) are imported into the Workbench.

Download a small example sample file here:

<http://www.resources.qiagenbioinformatics.com/madata/AffymetrixMetrics.txt>

K.2.3 Affymetrix NetAffx annotation files

The NetAffx annotation files for Whole-Transcript Expression Gene arrays and 3' IVT Expression Analysis Arrays can be imported and used to annotate experiments as shown in section 27.2.3.

Download a small example annotation file here which includes header information:

<http://www.resources.qiagenbioinformatics.com/madata/AffymetrixNetAffxAnnotation.csv>

K.3 Illumina BeadChip

Both BeadChip expression data files from Illumina's BeadStudio software and the corresponding BeadChip annotation files are supported by *CLC Genomics Workbench*. The formats of the BeadStudio and annotation files have changed somewhat over time and various formats are supported.

K.3.1 Illumina expression data, compact format

An example of this format is shown below:

TargetID	AVG_Signal	BEAD_STDEV	Detection
GI_10047089-S	112.5	4.2	0.16903226
GI_10047091-S	127.6	4.8	0.76774194

All this information is imported into the Workbench. The `AVG_Signal` is used as the expression measure.

Download a small sample file here:

<http://www.resources.qiagenbioinformatics.com/madata/IlluminaBeadChipCompact.txt>

K.3.2 Illumina expression data, extended format

An example of this format is shown below:

TargetID	MIN_Signal	AVG_Signal	MAX_Signal	NARRAYS	ARRAY_STDEV	BEAD_STDEV	Avg_NBEBADS	Detection
GI_10047089-S	73.7	73.7	73.7	1	NaN	3.4	53	0.05669084
GI_10047091-S	312.7	312.7	312.7	1	NaN	11.1	50	0.99604483

All this information is imported into the Workbench. The `AVG_Signal` is used as the expression measure.

Download a small sample file here:

<http://www.resources.qiagenbioinformatics.com/madata/IlluminaBeadChipExtended.txt>

K.3.3 Illumina expression data, with annotations

An example of this format is shown below:

TargetID	Accession	Symbol	Definition	Synonym	Signal-BG02	DCp32	Detection-BG02	DCp32
GI_10047089-S	NM_014332.1	SMPX	"Homo sapiens small muscle protein, X-linked (SMPX), mRNA."		-17.6		0.03559657	
GI_10047091-S	NM_013259.1	NP25	"Homo sapiens neuronal protein (NP25), mRNA."	NP22	32.6		0.99604483	
GI_10047093-S	NM_016299.1	HSP70-4	"Homo sapiens likely ortholog of mouse heat shock protein, 70 kDa 4 (HSP70-4), mRNA."		228.1	1		

Only the TargetID, Signal and Detection columns will be imported, the remaining columns will be ignored. This means that the annotations are not imported. The Signal is used as the expression measure.

Download a small example sample file here:

<http://www.resources.qiagenbioinformatics.com/madata/IlluminaBeadStudioWithAnnotation.txt>

K.3.4 Illumina expression data, multiple samples in one file

This file format has too much information to show it inline in the text. You can download a small example sample file here:

<http://www.resources.qiagenbioinformatics.com/madata/IlluminaBeadStudioMultipleSamples.txt>

This file contains data for 18 samples. Each sample has an expression value (the value in the AVG_Signal column), a detection p-value, a bead standard deviation and an average bead number column. The workbench recognizes the 18 samples and their columns.

K.3.5 Illumina annotation files

The Workbench supports import of two types of Illumina BeadChip annotation files. These are either comma-separated or tab-delimited .txt files. They can be used to annotate experiments as shown in section 27.2.3.

This file format has too much information to show it inline in the text.

Download a small example annotation file of the first type here:

<http://www.resources.qiagenbioinformatics.com/madata/IlluminaBeadChipAnnotation.txt>

K.4 Gene ontology annotation files

The Gene ontology web site provides annotation files for a variety of species which can all be downloaded and imported into the *CLC Genomics Workbench*. This can be used to annotate experiments as shown in section 27.2.3. See the complete list including download links at <http://www.geneontology.org/GO.current.annotations.shtml>.

This is an easy way to annotate your experiment with GO categories.

K.5 Generic expression and annotation data file formats

If you have your expression or annotation data in Excel and can export the data as a txt file, or if you are able to do some scripting or other manipulations to format your data files, you will be able to import them into the *CLC Genomics Workbench* as a 'generic' expression or annotation data file. There are a few simple requirements that need to be fulfilled to do this as described below.

K.5.1 Generic expression data table format

The *CLC Genomics Workbench* will import a tab, semicolon or comma-separated .txt or .csv file as expression array samples if the following requirements are met:

1. the first non-empty line of the file contains text. All entries, except the first, will be used as sample names
2. the following (non-empty) lines contain the same number of entries as the first non-empty line. The requirements to these are that the first entry should be a string (this will be used as the feature ID) and the remaining entries should contain numbers (which will be used as expression values – one per sample). Empty entries are not allowed, but NaN values are allowed.
3. the file contains at least two samples.

An example of this format is shown below:

```
FeatureID;sample1;sample2;sample3
gene1;200;300;23
gene2;210;30;238
gene3;230;50;23
gene4;50;100;235
gene5;200;300;23
gene6;210;30;238
gene7;230;50;23
gene8;50;100;235
```

This will be imported as three samples with eight genes in each sample.

Download a this example as a file here:

<http://www.resources.qiagenbioinformatics.com/madata/CustomExpressionData.txt>

K.5.2 Generic annotation file for expression data format

The *CLC Genomics Workbench* will import a tab, semicolon or comma-separated .txt or .csv file as an annotation file if the following is met:

1. It has a line which can serve as a valid header line. In order to do this, the line should have a number of headers where at least two are among the valid column headers in the **Column header** column below.
2. It contains one of the PROBE_ID headers (that is: 'Probe Set ID', 'Feature ID', 'ProbeID' or 'Probe_Id').

The importer will import an annotation table with a column for each of the valid column headers (those in the **Column header** column below). Columns with invalid headers will be ignored.

Note that some column headers are alternatives so that only one of the alternative columns headers should be used.

When adding annotations to an experiment, you can specify the column in your annotation file containing the relevant identifiers. These identifiers are matched to the feature ids already present in your experiment. When a match is found, the annotation is added to that entry in the experiment. In other words, at least one column in your annotation file must contain identifiers matching the feature identifiers in the experiment, for those annotations to be applied.

A simple example of an annotation file is shown here:

```
"Probe Set ID","Gene Symbol","Gene Ontology Biological Process"
"1367452_at","Sumo2","0006464 // protein modification process // not recorded"
"1367453_at","Cdc37","0051726 // regulation of cell cycle // not recorded"
"1367454_at","Cobb2","0006810 // transport // // 0016044 // membrane organization // "
```

Download this example plus a more elaborate one here:

<http://www.resources.qiagenbioinformatics.com/madata/SimpleCustomAnnotation.csv>

<http://www.resources.qiagenbioinformatics.com/madata/FullCustomAnnotation.csv>

To meet requirements imposed by special functionalities in the workbench, there are a number of further restrictions on the contents in the entries of the columns:

Download sequence functionality In the experiment table, you can click a button to download sequence. This uses the contents of the PUBLIC_ID column, so this column must be present for the action to work and should contain the NCBI accession number.

Annotation tests The annotation tests can make use of several entries in a column as long as a certain format is used. The tests assume that entries are separated by /// and it interprets all that appears before // as the actual entry and all that appears after // within an entry as comments. Example:

```
/// 0000001 // comment1 /// 0000008 // comment2 /// 0003746 // comment3
```

The annotation tests will interpret this as three entries (0000001, 0000008, and 0003746) with the according comments.

The most common column headers are summarized below:

Column header in imported file (alternatives separated by commas)	Label in experiment table	Description (tool tip)
Probe Set ID, Feature ID, ProbelD, Probe_Id, transcript_cluster_id	Feature ID	Probe identifier tag
Representative Public ID, Public identifier tag, GenbankAccession	Public identifier tag	Representative public ID
Gene Symbol, GeneSymbol	Gene symbol	Gene symbol
Gene Ontology Biological Process, Ontology_Process, GO_biological_process	GO biological process	Gene Ontology biological process
Gene Ontology Cellular Component, Ontology_Component, GO_cellular_component	GO cellular component	Gene Ontology cellular component
Gene Ontology Molecular Function, Ontology_Function, GO_molecular_function	GO molecular function	Gene Ontology molecular function
Pathway	Pathway	Pathway

The full list of possible column headers:

Column header in imported file (alternatives separated by commas)	Label in experiment table	Description (tool tip)
Species Scientific Name, Species Name, Species	Species name	Scientific species name
GeneChip Array	Gene chip array	Gene Chip Array name
Annotation Date	Annotation date	Date of annotation
Sequence Type	Sequence type	Type of sequence
Sequence Source	Sequence source	Source from which sequence was obtained
Transcript ID(Array Design), Transcript	Transcript ID	Transcript identifier tag
Target Description	Target description	Target description
Archival UniGene Cluster	Archival UniGene cluster	Archival UniGene cluster
UniGene ID, UniGeneID, Unigene_ID, unigene	UniGene ID	UniGene identifier tag
Genome Version	Genome version	Version of genome on which annotation is based
Alignments	Alignments	Alignments
Gene Title	Gene title	Gene title
geng_assignments	Gene assignments	Gene assignments
Chromosomal Location	Chromosomal location	Chromosomal location
Unigene Cluster Type	UniGene cluster type	UniGene cluster type
Ensembl Ensembl	Ensembl	
Entrez Gene, EntrezGeneID, Entrez_Gene_ID	Entrez gene	Entrez gene
SwissProt	SwissProt	SwissProt
EC	EC	EC
OMIM	OMIM	Online Mendelian Inheritance in Man
RefSeq Protein ID	RefSeq protein ID	RefSeq protein identifier tag
RefSeq Transcript ID	RefSeq transcript ID	RefSeq transcript identifier tag
FlyBase	FlyBase	FlyBase
AGI	AGI	AGI
WormBase	WormBase	WormBase
MGI Name	MGI name	MGI name
RGD Name	RGD name	RGD name
SGD accession number	SGD accession number	SGD accession number
InterPro	InterPro	InterPro
Trans Membrane	Trans membrane	Trans membrane
QTL	QTL	QTL
Annotation Description	Annotation description	Annotation description
Annotation Transcript Cluster	Annotation transcript cluster	Annotation transcript cluster
Transcript Assignments	Transcript assignments	Transcript assignments
mma_assignments	mRNA assignments	mRNA assignments
Annotation Notes	Annotation notes	Annotation notes
GO, Ontology	Go annotations	Go annotations
Cytoband	Cytoband	Cytoband
PrimaryAccession	Primary accession	Primary accession
RefSeqAccession	RefSeq accession	RefSeq accession
GeneName	Gene name	Gene name
TIGRID	TIGR id	TIGR id
Description	Description	Description
GenomicCoordinates	Genomic coordinates	Genomic coordinates
Search_key	Search key	Search key
Target	Target	Target
Gid, GI	Genbank identifier	Genbank identifier
Accession	GenBank accession	GenBank accession
Symbol	Gene symbol	Gene symbol
Probe_Type	Probe type	Probe type
crosshyb_type	Crosshyb type	Crosshyb type
category	category	category
Start, Probe_Start	Start	Start
Stop	Stop	Stop
Definition	Definition	Definition
Synonym, Synonyms	Synonym	Synonym
Source	Source	Source
Source_Reference_ID	Source reference id	Source reference id
RefSeq_ID	Reference sequence id	Reference sequence id
ILMN_Gene	Illumina Gene	Illumina Gene
Protein_Product	Protein product	Protein product
protein_domains	Protein domains	Protein domains
Array_Address_Id	Array adress id	Array adress id
Probe_Sequence	Sequence	Sequence
seqname	Seqname	Seqname
Chromosome	Chromosome	Chromosome
strand	Strand	Strand
Probe_Chr_Orientation	Probe chr orientation	Probe chr orientation
Probe_Coordinates	Probe coordinates	Probe coordinates
Obsolete_Probe_Id	Obsolete probe id	Obsolete probe id

Appendix L

Custom codon frequency tables

You can edit the list of codon frequency tables used by *CLC Genomics Workbench*.

Note! Please be aware that this process needs to be handled carefully, otherwise you may have to re-install the Workbench to get it to work.

In the Workbench installation folder under `res`, there is a folder named `codonfreq`. This folder contains all the codon frequency tables organized into subfolders in a hierarchy. In order to change the tables, you simply add, delete or rename folders and the files in the folders. If you wish to add new tables, please use the existing ones as template. In existing tables, the "_number" at the end of the ".cftbl" file name is the number of CDSs that were used for calculation, according to the <http://www.kazusa.or.jp/codon/> site.

When creating a custom table, it is not necessary to fill in all fields as only the codon information (e.g. 'GCG' in the example below) and the counts (e.g. 47869.00) are used when doing reverse translation:

```
Name: Rattus norvegicus GeneticCode: 1 Ala GCG 47869.00 6.86 0.10 Ala GCA 109203.00  
15.64 0.23 ....
```

In particular, the amino acid type is not used: in order to use an alternative genetic code, it must be specified in the 'GeneticCode' line instead.

Restart the Workbench to have the changes take effect.

Appendix M

Comparison of track comparison tools

This section of the manual provides an overview about comparison, filtering and annotation tools that work with tracks.

Tool name	Description of the tool	Example of possible applications	Comments
Compare Samples within Group (see section 25.15.1)	Identifies common variants in a group of samples	Identification of common variants in inherited deafness	Can also be used to get all variants in a group of samples by setting the frequency threshold to 0%
TRIO analysis (see section 25.15.4)	Identifies de novo and accumulated variants in a child by comparing with the variants present in the mother and father	Identification of causative variants in rare mendelian diseases	-
Fisher Exact Test (see section 25.15.3)	Identifies enriched variants in a group of samples with a certain phenotype (the case group) in comparison to a group of samples not showing this phenotype (the control group). Control and case samples are from different individuals	Identification of causative common variants in non-rare diseases	To retrieve significant results, a large number of samples is required for each group

Tool name	Description of the tool	Example applications	Comments
Filter Against Control Reads (see section 25.15.5)	Removes germline variants from a set of called variants in a case sample (e.g. a cancer sample) by using mapped sequencing reads from a normal sample from the same individual	Comparison of cancer versus normal from the same patient	-
Filter against known variants (see section 25.14.1)	Removes variants that are present (or absent) in an external variant database (available as track) from a set of called variants	Removal of common (assumed germline) variants from a set of called variants in a case sample to identify somatic variants	-
Annotate against known variants (see section 25.14.2)	Adds information from one or several external database(s), that are available as track(s), to called variants in a sample to see how many of them are known in this(these) database(s)	Adds information from COSMIC to see how many of the variants found in the sample are known to be associated with cancer	The tool has special rules for when information from the database are transferred and when it is not. This means that only information is transferred in cases with exact matches (when the same variant is found in the sample AND the database) and in cases where variants in the database are completely contained in the set of variants that have been called in the sample
Filter based on overlap (see section 23.6)	Removes elements from a set of genetic annotations such as genes, regulatory elements, or variants. Only genetic annotations are kept that overlap or do not overlap regions in the other track	Removing deletions or amplifications that do not overlap genes to identify those that are potential causative. Filtering away variants outside targeted regions in an DNA amplification sequencing experiment	-
Compare Sample Variant Tracks (see section 25.15.2)	Removes variants called in one sample that are also called (or not called) in another sample for comparison	Sample/normal comparison	Please note that this tool has the same functionality as the Annotate against known variants tool, but should be used for called variants only and not for comparison or filtering using databases

Bibliography

- [Allison et al., 2006] Allison, D., Cui, X., Page, G., and Sabripour, M. (2006). Microarray data analysis: from disarray to consolidation and consensus. *NATURE REVIEWS GENETICS*, 7(1):55.
- [Altschul and Gish, 1996] Altschul, S. F. and Gish, W. (1996). Local alignment statistics. *Methods Enzymol*, 266:460–480.
- [Altschul et al., 1990] Altschul, S. F., Gish, W., Miller, W., Myers, E. W., and Lipman, D. J. (1990). Basic local alignment search tool. *J Mol Biol*, 215(3):403–410.
- [Andrade et al., 1998] Andrade, M. A., O'Donoghue, S. I., and Rost, B. (1998). Adaptation of protein surfaces to subcellular location. *J Mol Biol*, 276(2):517–525.
- [Auer and Doerge, 2010] Auer, P. L. and Doerge, R. (2010). Statistical design and analysis of rna sequencing data. *Genetics*, 185(2):405–416.
- [Bachmair et al., 1986] Bachmair, A., Finley, D., and Varshavsky, A. (1986). In vivo half-life of a protein is a function of its amino-terminal residue. *Science*, 234(4773):179–186.
- [Baggerly et al., 2003] Baggerly, K., Deng, L., Morris, J., and Aldaz, C. (2003). Differential expression in SAGE: accounting for normal between-library variation. *Bioinformatics*, 19(12):1477–1483.
- [Bateman et al., 2004] Bateman, A., Coin, L., Durbin, R., Finn, R. D., Hollich, V., Griffiths-Jones, S., Khanna, A., Marshall, M., Moxon, S., Sonnhammer, E. L., Studholme, D. J., Yeats, C., and Eddy, S. R. (2004). The Pfam protein families database. *Nucleic Acids Res.*, 32(Database issue):D138–D141.
- [Benjamini and Hochberg, 1995] Benjamini, Y. and Hochberg, Y. (1995). Controlling the false discovery rate: a practical and powerful approach to multiple testing. *JOURNAL-ROYAL STATISTICAL SOCIETY SERIES B*, 57:289–289.
- [Berman et al., 2003] Berman, H., Henrick, K., and Nakamura, H. (2003). Announcing the worldwide protein data bank. *Nat Struct Biol*, 10(12):980.
- [Bishop and Friday, 1985] Bishop, M. J. and Friday, A. E. (1985). Evolutionary trees from nucleic acid and protein sequences. *Proceeding of the Royal Society of London*, B 226:271–302.
- [Blaisdell, 1989] Blaisdell, B. E. (1989). Average values of a dissimilarity measure not requiring sequence alignment are twice the averages of conventional mismatch counts requiring sequence alignment for a computer-generated model system. *J Mol Evol*, 29(6):538–47.

- [Bolstad et al., 2003] Bolstad, B., Irizarry, R., Astrand, M., and Speed, T. (2003). A comparison of normalization methods for high density oligonucleotide array data based on variance and bias. *Bioinformatics*, 19(2):185–193.
- [Bommarito et al., 2000] Bommarito, S., Peyret, N., and SantaLucia, J. (2000). Thermodynamic parameters for DNA sequences with dangling ends. *Nucleic Acids Res*, 28(9):1929–1934.
- [Chen et al., 2004] Chen, G., Znosko, B. M., Jiao, X., and Turner, D. H. (2004). Factors affecting thermodynamic stabilities of RNA 3 x 3 internal loops. *Biochemistry*, 43(40):12865–12876.
- [Clote et al., 2005] Clote, P., Ferré, F., Kranakis, E., and Krizanc, D. (2005). Structural RNA has lower folding energy than random RNA of the same dinucleotide frequency. *RNA*, 11(5):578–591.
- [Cornette et al., 1987] Cornette, J. L., Cease, K. B., Margalit, H., Spouge, J. L., Berzofsky, J. A., and DeLisi, C. (1987). Hydrophobicity scales and computational techniques for detecting amphipathic structures in proteins. *J Mol Biol*, 195(3):659–685.
- [Costa, 2007] Costa, F. F. (2007). Non-coding RNAs: lost in translation? *Gene*, 386(1-2):1–10.
- [Creighton et al., 2009] Creighton, C. J., Reid, J. G., and Gunaratne, P. H. (2009). Expression profiling of micrnas by deep sequencing. *Brief Bioinform*, 10(5):490–497.
- [Cronn et al., 2008] Cronn, R., Liston, A., Parks, M., Gernandt, D. S., Shen, R., and Mockler, T. (2008). Multiplex sequencing of plant chloroplast genomes using solexa sequencing-by-synthesis technology. *Nucleic Acids Res*, 36(19):e122.
- [Crooks et al., 2004] Crooks, G. E., Hon, G., Chandonia, J.-M., and Brenner, S. E. (2004). WebLogo: a sequence logo generator. *Genome Res*, 14(6):1188–1190.
- [Dayhoff and Schwartz, 1978] Dayhoff, M. O. and Schwartz, R. M. (1978). *Atlas of Protein Sequence and Structure*, volume 3 of 5 suppl., pages 353–358. Nat. Biomed. Res. Found., Washington D.C.
- [Dayhoff et al., 1978] Dayhoff, M. O., Schwartz, R. M., and Orcutt, B. C. (1978). A model of evolutionary change in protein. *Atlas of Protein Sequence and Structure*, 5(3):345–352.
- [Dempster et al., 1977] Dempster, A., Laird, N., Rubin, D., et al. (1977). Maximum likelihood from incomplete data via the EM algorithm. *Journal of the Royal Statistical Society*, 39(1):1–38.
- [Dudoit et al., 2003] Dudoit, S., Shaffer, J., and Boldrick, J. (2003). Multiple Hypothesis Testing in Microarray Experiments. *STATISTICAL SCIENCE*, 18(1):71–103.
- [Eddy, 2004] Eddy, S. R. (2004). Where did the BLOSUM62 alignment score matrix come from? *Nat Biotechnol*, 22(8):1035–1036.
- [Edgar, 2004] Edgar, R. C. (2004). Muscle: a multiple sequence alignment method with reduced time and space complexity. *BMC Bioinformatics*, 5:113.
- [Efron, 1982] Efron, B. (1982). *The jackknife, the bootstrap and other resampling plans*, volume 38. SIAM.
- [Eisen et al., 1998] Eisen, M., Spellman, P., Brown, P., and Botstein, D. (1998). Cluster analysis and display of genome-wide expression patterns. *Proceedings of the National Academy of Sciences*, 95(25):14863–14868.

- [Eisenberg et al., 1984] Eisenberg, D., Schwarz, E., Komaromy, M., and Wall, R. (1984). Analysis of membrane and surface protein sequences with the hydrophobic moment plot. *J Mol Biol*, 179(1):125–142.
- [Emini et al., 1985] Emini, E. A., Hughes, J. V., Perlow, D. S., and Boger, J. (1985). Induction of hepatitis a virus-neutralizing antibody by a virus-specific synthetic peptide. *J Virol*, 55(3):836–839.
- [Engelman et al., 1986] Engelman, D. M., Steitz, T. A., and Goldman, A. (1986). Identifying nonpolar transbilayer helices in amino acid sequences of membrane proteins. *Annu Rev Biophys Chem*, 15:321–353.
- [Falcon and Gentleman, 2007] Falcon, S. and Gentleman, R. (2007). Using GOstats to test gene lists for GO term association. *Bioinformatics*, 23(2):257.
- [Felsenstein, 1981] Felsenstein, J. (1981). Evolutionary trees from DNA sequences: a maximum likelihood approach. *J Mol Evol*, 17(6):368–376.
- [Felsenstein, 1985] Felsenstein, J. (1985). Confidence limits on phylogenies: An approach using the bootstrap. *Journal of Molecular Evolution*, 39:783–791.
- [Feng and Doolittle, 1987] Feng, D. F. and Doolittle, R. F. (1987). Progressive sequence alignment as a prerequisite to correct phylogenetic trees. *J Mol Evol*, 25(4):351–360.
- [Forsberg et al., 2001] Forsberg, R., Oleksiewicz, M. B., Petersen, A. M., Hein, J., Bøtner, A., and Storgaard, T. (2001). A molecular clock dates the common ancestor of European-type porcine reproductive and respiratory syndrome virus at more than 10 years before the emergence of disease. *Virology*, 289(2):174–179.
- [Galperin and Koonin, 1998] Galperin, M. Y. and Koonin, E. V. (1998). Sources of systematic error in functional annotation of genomes: domain rearrangement, non-orthologous gene displacement and operon disruption. *In Silico Biol*, 1(1):55–67.
- [Gentleman and Mullin, 1989] Gentleman, J. F. and Mullin, R. (1989). The distribution of the frequency of occurrence of nucleotide subsequences, based on their overlap capability. *Biometrics*, 45(1):35–52.
- [Gill and von Hippel, 1989] Gill, S. C. and von Hippel, P. H. (1989). Calculation of protein extinction coefficients from amino acid sequence data. *Anal Biochem*, 182(2):319–326.
- [Gnerre et al., 2011] Gnerre, S., Maccallum, I., Przybylski, D., Ribeiro, F. J., Burton, J. N., Walker, B. J., Sharpe, T., Hall, G., Shea, T. P., Sykes, S., Berlin, A. M., Aird, D., Costello, M., Daza, R., Williams, L., Nicol, R., Gnirke, A., Nusbaum, C., Lander, E. S., and Jaffe, D. B. (2011). High-quality draft assemblies of mammalian genomes from massively parallel sequence data. *Proceedings of the National Academy of Sciences of the United States of America*, 108(4):1513–8.
- [Gonda et al., 1989] Gonda, D. K., Bachmair, A., Wüning, I., Tobias, J. W., Lane, W. S., and Varshavsky, A. (1989). Universality and structure of the N-end rule. *J Biol Chem*, 264(28):16700–16712.
- [Guindon and Gascuel, 2003] Guindon, S. and Gascuel, O. (2003). A Simple, Fast, and Accurate Algorithm to Estimate Large Phylogenies by Maximum Likelihood. *Systematic Biology*, 52(5):696–704.

- [Guo et al., 2006] Guo, L., Lobenhofer, E. K., Wang, C., Shippy, R., Harris, S. C., Zhang, L., Mei, N., Chen, T., Herman, D., Goodsaid, F. M., Hurban, P., Phillips, K. L., Xu, J., Deng, X., Sun, Y. A., Tong, W., Dragan, Y. P., and Shi, L. (2006). Rat toxicogenomic study reveals analytical consistency across microarray platforms. *Nat Biotechnol*, 24(9):1162–1169.
- [Han et al., 1999] Han, K., Kim, D., and Kim, H. (1999). A vector-based method for drawing RNA secondary structure. *Bioinformatics*, 15(4):286–297.
- [Hasegawa et al., 1985] Hasegawa, M., Kishino, H., and Yano, T. (1985). Dating of the human–ape splitting by a molecular clock of mitochondrial DNA. *Journal of Molecular Evolution*, 22(2):160–174.
- [Hein, 2001] Hein, J. (2001). An algorithm for statistical alignment of sequences related by a binary tree. In *Pacific Symposium on Biocomputing*, page 179.
- [Hein et al., 2000] Hein, J., Wiuf, C., Knudsen, B., Møller, M. B., and Wibling, G. (2000). Statistical alignment: computational properties, homology testing and goodness-of-fit. *J Mol Biol*, 302(1):265–279.
- [Henikoff and Henikoff, 1992] Henikoff, S. and Henikoff, J. G. (1992). Amino acid substitution matrices from protein blocks. *Proc Natl Acad Sci U S A*, 89(22):10915–10919.
- [Heydarian et al., 2014] Heydarian, M., Romeo Luperchio, T., Cutler, J., Mitchell, C., Kim, M.-S., Pandey, A., Soliner-Webb, B., and Reddy, K. (2014). Prediction of gene activity in early B cell development based on an integrative multi-omics analysis. *J Proteomics Bioinform*, 7(2):050–063.
- [Höhl et al., 2007] Höhl, M., Rigoutsos, I., and Ragan, M. A. (2007). Pattern-based phylogenetic distance estimation and tree reconstruction. *Evolutionary Bioinformatics*, 2:0–0.
- [Homer N, 2010] Homer N, N. S. (2010). Improved variant discovery through local re-alignment of short-read next-generation sequencing data using srma. *Genome Biol.*, 11(10):R99.
- [Hopp and Woods, 1983] Hopp, T. P. and Woods, K. R. (1983). A computer program for predicting protein antigenic determinants. *Mol Immunol*, 20(4):483–489.
- [Ikai, 1980] Ikai, A. (1980). Thermostability and aliphatic index of globular proteins. *J Biochem (Tokyo)*, 88(6):1895–1898.
- [Janin, 1979] Janin, J. (1979). Surface and inside volumes in globular proteins. *Nature*, 277(5696):491–492.
- [Jones et al., 1992] Jones, D., Taylor, W., and Thornton, J. (1992). The rapid generation of mutation data matrices from protein sequences. *Computer Applications in the Biosciences (CABIOS)*, 8:275–282.
- [Jukes and Cantor, 1969] Jukes, T. and Cantor, C. (1969). *Mammalian Protein Metabolism*, chapter Evolution of protein molecules, pages 21–32. New York: Academic Press.
- [Kal et al., 1999] Kal, A. J., van Zonneveld, A. J., Benes, V., van den Berg, M., Koerkamp, M. G., Albermann, K., Strack, N., Ruijter, J. M., Richter, A., Dujon, B., Ansorge, W., and Tabak, H. F. (1999). Dynamics of gene expression revealed by comparison of serial analysis of gene expression transcript profiles from yeast grown on two different carbon sources. *Mol Biol Cell*, 10(6):1859–1872.

- [Karplus and Schulz, 1985] Karplus, P. A. and Schulz, G. E. (1985). Prediction of chain flexibility in proteins. *Naturwissenschaften*, 72:212–213.
- [Kaufman and Rousseeuw, 1990] Kaufman, L. and Rousseeuw, P. (1990). Finding groups in data. an introduction to cluster analysis. *Wiley Series in Probability and Mathematical Statistics. Applied Probability and Statistics*, New York: Wiley, 1990.
- [Kierzek et al., 1999] Kierzek, R., Burkard, M. E., and Turner, D. H. (1999). Thermodynamics of single mismatches in RNA duplexes. *Biochemistry*, 38(43):14214–14223.
- [Kimura, 1980] Kimura, M. (1980). A simple method for estimating evolutionary rates of base substitutions through comparative studies of nucleotide sequences. *J Mol Evol*, 16(2):111–120.
- [Knudsen and Miyamoto, 2001] Knudsen, B. and Miyamoto, M. M. (2001). A likelihood ratio test for evolutionary rate shifts and functional divergence among proteins. *Proc Natl Acad Sci U S A*, 98(25):14512–14517.
- [Knudsen and Miyamoto, 2003] Knudsen, B. and Miyamoto, M. M. (2003). Sequence alignments and pair hidden markov models using evolutionary history. *Journal of Molecular Biology*, 333(2):453 – 460.
- [Kolaskar and Tongaonkar, 1990] Kolaskar, A. S. and Tongaonkar, P. C. (1990). A semi-empirical method for prediction of antigenic determinants on protein antigens. *FEBS Lett*, 276(1-2):172-174.
- [Kumar et al., 2013] Kumar, V., Muratani, M., Rayan, N. A., Kraus, P., Lufkin, T., Ng, H. H., and Prabhakar, S. (2013). Uniform, optimal signal processing of mapped deep-sequencing data. *Nat Biotechnol*, 31(7):615–22.
- [Kyte and Doolittle, 1982] Kyte, J. and Doolittle, R. F. (1982). A simple method for displaying the hydrophobic character of a protein. *J Mol Biol*, 157(1):105–132.
- [Landt et al., 2012] Landt, S. G., Marinov, G. K., Kundaje, A., Kheradpour, P., Pauli, F., Batzoglou, S., Bernstein, B. E., Bickel, P., Brown, J. B., Cayting, P., Chen, Y., DeSalvo, G., Epstein, C., Fisher-Aylor, K. I., Euskirchen, G., Gerstein, M., Gertz, J., Hartemink, A. J., Hoffman, M. M., Iyer, V. R., Jung, Y. L., Karmakar, S., Kellis, M., Kharchenko, P. V., Li, Q., Liu, T., Liu, X. S., Ma, L., Milosavljevic, A., Myers, R. M., Park, P. J., Pazin, M. J., Perry, M. D., Raha, D., Reddy, T. E., Rozowsky, J., Shores, N., Sidow, A., Slattery, M., Stamatoyannopoulos, J. A., Tolstorukov, M. Y., White, K. P., Xi, S., Farnham, P. J., Lieb, J. D., Wold, B. J., and Snyder, M. (2012). ChIP-seq guidelines and practices of the ENCODE and modENCODE consortia. *Genome Res*, 22(9):1813–31.
- [Law et al., 2014] Law, V., Knox, C., Djoumbou, Y., Jewison, T., Guo, A., Liu, Y., Maciejewski, A., Arndt, D., Wilson, M., Neveu, V., Tang, A., Gabriel, G., Ly, C., Adamjee, S., Dame, Z., Han, B., Zhou, Y., and Wishart, D. (2014). Drugbank 4.0: shedding new light on drug metabolism. *Nucleic Acids Res.*, 42:D1091–7.
- [Leitner and Albert, 1999] Leitner, T. and Albert, J. (1999). The molecular clock of HIV-1 unveiled through analysis of a known transmission history. *Proc Natl Acad Sci U S A*, 96(19):10752–10757.

- [Li et al., 2010] Li, R., Zhu, H., Ruan, J., Qian, W., Fang, X., Shi, Z., Li, Y., Li, S., Shan, G., Kristiansen, K., Li, S., Yang, H., Wang, J., and Wang, J. (2010). De novo assembly of human genomes with massively parallel short read sequencing. *Genome research*, 20(2):265–72.
- [Lloyd, 1982] Lloyd, S. (1982). Least squares quantization in PCM. *Information Theory, IEEE Transactions on*, 28(2):129–137.
- [Longfellow et al., 1990] Longfellow, C. E., Kierzek, R., and Turner, D. H. (1990). Thermodynamic and spectroscopic study of bulge loops in oligoribonucleotides. *Biochemistry*, 29(1):278–285.
- [Lu et al., 2008] Lu, M., Dousis, A. D., and Ma, J. (2008). Opus-rotax: A fast and accurate method for side-chain modeling. *Protein Science*, 17(9):1576–1585.
- [Maizel and Lenk, 1981] Maizel, J. V. and Lenk, R. P. (1981). Enhanced graphic matrix analysis of nucleic acid and protein sequences. *Proc Natl Acad Sci U S A*, 78(12):7665–7669.
- [Marinov et al., 2014] Marinov, G. K., Kundaje, A., Park, P. J., and Wold, B. J. (2014). Large-scale quality analysis of published ChIP-seq data. *G3 (Bethesda)*, 4(2):209–23.
- [Mathews et al., 2004] Mathews, D. H., Disney, M. D., Childs, J. L., Schroeder, S. J., Zuker, M., and Turner, D. H. (2004). Incorporating chemical modification constraints into a dynamic programming algorithm for prediction of rna secondary structure. *Proc Natl Acad Sci U S A*, 101(19):7287–7292.
- [Mathews et al., 1999] Mathews, D. H., Sabina, J., Zuker, M., and Turner, D. H. (1999). Expanded sequence dependence of thermodynamic parameters improves prediction of rna secondary structure. *J Mol Biol*, 288(5):911–940.
- [Mathews and Turner, 2002] Mathews, D. H. and Turner, D. H. (2002). Experimentally derived nearest-neighbor parameters for the stability of RNA three- and four-way multibranch loops. *Biochemistry*, 41(3):869–880.
- [Mathews and Turner, 2006] Mathews, D. H. and Turner, D. H. (2006). Prediction of RNA secondary structure by free energy minimization. *Curr Opin Struct Biol*, 16(3):270–278.
- [McCaskill, 1990] McCaskill, J. S. (1990). The equilibrium partition function and base pair binding probabilities for RNA secondary structure. *Biopolymers*, 29(6-7):1105–1119.
- [McGinnis and Madden, 2004] McGinnis, S. and Madden, T. L. (2004). BLAST: at the core of a powerful and diverse set of sequence analysis tools. *Nucleic Acids Res*, 32(Web Server issue):W20–W25.
- [Meyer et al., 2007] Meyer, M., Stenzel, U., Myles, S., Prüfer, K., and Hofreiter, M. (2007). Targeted high-throughput sequencing of tagged nucleic acid samples. *Nucleic Acids Res*, 35(15):e97.
- [Miao et al., 2011] Miao, Z., Cao, Y., and Jiang, T. (2011). Rasp: rapid modeling of protein side chain conformations. *Bioinformatics*, 27(22):3117–3122.
- [Michener and Sokal, 1957] Michener, C. and Sokal, R. (1957). A quantitative approach to a problem in classification. *Evolution*, 11:130–162.

- [Morin et al., 2008] Morin, R. D., O'Connor, M. D., Griffith, M., Kuchenbauer, F., Delaney, A., Prabhu, A.-L., Zhao, Y., McDonald, H., Zeng, T., Hirst, M., Eaves, C. J., and Marra, M. A. (2008). Application of massively parallel sequencing to microRNA profiling and discovery in human embryonic stem cells. *Genome Res*, 18(4):610–621.
- [Morrison, 1968] Morrison, D. R. (1968). Patricia – practical algorithm to retrieve information coded in alphanumeric. *J. ACM*, 15(4):514–534.
- [Mortazavi et al., 2008] Mortazavi, A., Williams, B. A., McCue, K., Schaeffer, L., and Wold, B. (2008). Mapping and quantifying mammalian transcriptomes by rna-seq. *Nat Methods*, 5(7):621–628.
- [Mukherjee and Zhang, 2009] Mukherjee, S. and Zhang, Y. (2009). MM-align: A quick algorithm for aligning multiple-chain protein complex structures using iterative dynamic programming. *Nucleic Acids Res.*, 37.
- [Nguyen et al., 2011] Nguyen, P., Ma, J., Pei, D., Obert, C., Cheng, C., and Geiger, T. (2011). Identification of errors introduced during high throughput sequencing of the t cell receptor repertoire. *BMC genomics*, 12(1):106.
- [Parkhomchuk et al., 2009] Parkhomchuk, D., Borodina, T., Amstislavskiy, V., Banaru, M., Hallen, L., Krobitsch, S., Lehrach, H., and Soldatov, A. (2009). Transcriptome analysis by strand-specific sequencing of complementary dna. *Nucleic Acids Res*, 37(18):e123.
- [Purvis, 1995] Purvis, A. (1995). A composite estimate of primate phylogeny. *Philos Trans R Soc Lond B Biol Sci*, 348(1326):405–421.
- [Rivas and Eddy, 2000] Rivas, E. and Eddy, S. R. (2000). Secondary structure alone is generally not statistically significant for the detection of noncoding RNAs. *Bioinformatics*, 16(7):583–605.
- [Robinson et al., 2010] Robinson, M. D., McCarthy, D. J., and Smyth, G. K. (2010). edgeR: a bioconductor package for differential expression analysis of digital gene expression data. *Bioinformatics*, 26(1):139–140.
- [Robinson and Oshlack, 2010] Robinson, M. D. and Oshlack, A. (2010). A scaling normalization method for differential expression analysis of RNA-seq data. *Genome Biol.*, 11(3):R25.
- [Robinson and Smyth, 2007] Robinson, M. D. and Smyth, G. K. (2007). Moderated statistical tests for assessing differences in tag abundance. *Bioinformatics*, 23(21):2881–2887.
- [Robinson and Smyth, 2008] Robinson, M. D. and Smyth, G. K. (2008). Small-sample estimation of negative binomial dispersion, with applications to sage data. *Biostatistics*, 9(2):321–332.
- [Rose et al., 1985] Rose, G. D., Geselowitz, A. R., Lesser, G. J., Lee, R. H., and Zehfus, M. H. (1985). Hydrophobicity of amino acid residues in globular proteins. *Science*, 229(4716):834–838.
- [Rost, 2001] Rost, B. (2001). Review: protein secondary structure prediction continues to rise. *J Struct Biol*, 134(2-3):204–218.
- [Rye et al., 2011] Rye, M. B., Sætrom, P., and Drabløs, F. (2011). A manually curated ChIP-seq benchmark demonstrates room for improvement in current peak-finder programs. *Nucleic Acids Res*, 39(4):e25.

- [Saitou and Nei, 1987] Saitou, N. and Nei, M. (1987). The neighbor-joining method: a new method for reconstructing phylogenetic trees. *Mol Biol Evol*, 4(4):406–425.
- [Sankoff et al., 1983] Sankoff, D., Kruskal, J., Mainville, S., and Cedergren, R. (1983). *Time Warps, String Edits, and Macromolecules: the Theory and Practice of Sequence Comparison*, chapter Fast algorithms to determine RNA secondary structures containing multiple loops, pages 93–120. Addison-Wesley, Reading, Ma.
- [SantaLucia, 1998] SantaLucia, J. (1998). A unified view of polymer, dumbbell, and oligonucleotide DNA nearest-neighbor thermodynamics. *Proc Natl Acad Sci U S A*, 95(4):1460–1465.
- [Schechter and Berger, 1967] Schechter, I. and Berger, A. (1967). On the size of the active site in proteases. I. Papain. *Biochem Biophys Res Commun*, 27(2):157–162.
- [Schechter and Berger, 1968] Schechter, I. and Berger, A. (1968). On the active site of proteases. 3. Mapping the active site of papain; specific peptide inhibitors of papain. *Biochem Biophys Res Commun*, 32(5):898–902.
- [Schneider and Stephens, 1990] Schneider, T. D. and Stephens, R. M. (1990). Sequence logos: a new way to display consensus sequences. *Nucleic Acids Res*, 18(20):6097–6100.
- [Schroeder et al., 1999] Schroeder, S. J., Burkard, M. E., and Turner, D. H. (1999). The energetics of small internal loops in RNA. *Biopolymers*, 52(4):157–167.
- [Shapiro et al., 2007] Shapiro, B. A., Yingling, Y. G., Kasprzak, W., and Bindewald, E. (2007). Bridging the gap in RNA structure prediction. *Curr Opin Struct Biol*, 17(2):157–165.
- [Siepel and Haussler, 2004] Siepel, A. and Haussler, D. (2004). Combining phylogenetic and hidden Markov models in biosequence analysis. *J Comput Biol*, 11(2-3):413–428.
- [Smith and Waterman, 1981] Smith, T. F. and Waterman, M. S. (1981). Identification of common molecular subsequences. *J Mol Biol*, 147(1):195–197.
- [Stanton et al., 2013] Stanton, K. P., Parisi, F., Strino, F., Rabin, N., Asp, P., and Kluger, Y. (2013). Arpeggio: harmonic compression of ChIP-seq data reveals protein-chromatin interaction signatures. *Nucleic Acids Res*, 41(16):e161.
- [Stark et al., 2010] Stark, M. S., Tyagi, S., Nancarrow, D. J., Boyle, G. M., Cook, A. L., Whiteman, D. C., Parsons, P. G., Schmidt, C., Sturm, R. A., and Hayward, N. K. (2010). Characterization of the melanoma mirnaome by deep sequencing. *PLoS One*, 5(3):e9685.
- [Sturges, 1926] Sturges, H. A. (1926). The choice of a class interval. *Journal of the American Statistical Association*, 21:65–66.
- [Tian et al., 2005] Tian, L., Greenberg, S., Kong, S., Altschuler, J., Kohane, I., and Park, P. (2005). Discovering statistically significant pathways in expression profiling studies. *Proceedings of the National Academy of Sciences*, 102(38):13544–13549.
- [Tobias et al., 1991] Tobias, J. W., Shrader, T. E., Rocap, G., and Varshavsky, A. (1991). The N-end rule in bacteria. *Science*, 254(5036):1374–1377.
- [Tusher et al., 2001] Tusher, V. G., Tibshirani, R., and Chu, G. (2001). Significance analysis of microarrays applied to the ionizing radiation response. *Proc Natl Acad Sci U S A*, 98(9):5116–5121.

- [von Ahsen et al., 2001] von Ahsen, N., Wittwer, C. T., and Schütz, E. (2001). Oligonucleotide melting temperatures under PCR conditions: nearest-neighbor corrections for Mg(2+), deoxynucleotide triphosphate, and dimethyl sulfoxide concentrations with comparison to alternative empirical formulas. *Clin Chem*, 47(11):1956–1961.
- [Welling et al., 1985] Welling, G. W., Weijer, W. J., van der Zee, R., and Welling-Wester, S. (1985). Prediction of sequential antigenic regions in proteins. *FEBS Lett*, 188(2):215–218.
- [Whelan and Goldman, 2001] Whelan, S. and Goldman, N. (2001). A general empirical model of protein evolution derived from multiple protein families using a maximum-likelihood approach. *Molecular Biology and Evolution*, 18:691–699.
- [Wishart et al., 2006] Wishart, D., Knox, C., Guo, A., Shrivastava, S., Hassanali, M., Stothard, P., Chang, Z., and Woolsey, J. (2006). Drugbank: a comprehensive resource for in silico drug discovery and exploration. *Nucleic Acids Res.*, 34:D668–72.
- [Wootton and Federhen, 1993] Wootton, J. C. and Federhen, S. (1993). Statistics of local complexity in amino acid sequences and sequence databases. *Computers in Chemistry*, 17:149–163.
- [Workman and Krogh, 1999] Workman, C. and Krogh, A. (1999). No evidence that mRNAs have lower folding free energies than random sequences with the same dinucleotide distribution. *Nucleic Acids Res*, 27(24):4816–4822.
- [Wyman et al., 2009] Wyman, S. K., Parkin, R. K., Mitchell, P. S., Fritz, B. R., O'Briant, K., Godwin, A. K., Urban, N., Drescher, C. W., Knudsen, B. S., and Tewari, M. (2009). Repertoire of micrnas in epithelial ovarian cancer as determined by next generation sequencing of small rna cdna libraries. *PLoS One*, 4(4):e5311.
- [Xu and Zhang, 2010] Xu, J. and Zhang, Y. (2010). How significant is a protein structure similarity with TM-score = 0.5? *Bioinformatics*, 26(7):889–95.
- [Yang, 1994a] Yang, Z. (1994a). Estimating the pattern of nucleotide substitution. *Journal of Molecular Evolution*, 39(1):105–111.
- [Yang, 1994b] Yang, Z. (1994b). Maximum likelihood phylogenetic estimation from DNA sequences with variable rates over sites: Approximate methods. *Journal of Molecular Evolution*, 39(3):306–314.
- [Zerbino and Birney, 2008] Zerbino, D. R. and Birney, E. (2008). Velvet: algorithms for de novo short read assembly using de Bruijn graphs. *Genome Res*, 18(5):821–829.
- [Zerbino et al., 2009] Zerbino, D. R., McEwen, G. K., Margulies, E. H., and Birney, E. (2009). Pebble and rock band: heuristic resolution of repeats and scaffolding in the velvet short-read de novo assembler. *PLoS one*, 4(12):e8407.
- [Zhang and Skolnick, 2004] Zhang, Y. and Skolnick, J. (2004). Scoring function for automated assessment of protein structure template quality. *Proteins*, 57(4):702–10.
- [Zuker, 1989a] Zuker, M. (1989a). On finding all suboptimal foldings of an rna molecule. *Science*, 244(4900):48–52.
- [Zuker, 1989b] Zuker, M. (1989b). The use of dynamic programming algorithms in rna secondary structure prediction. *Mathematical Methods for DNA Sequences*, pages 159–184.

- [Zuker and Sankoff, 1984] Zuker, M. and Sankoff, D. (1984). Rna secondary structures and their prediction. *Bulletin of Mathematical Biology*, 46:591–621.
- [Zuker and Stiegler, 1981] Zuker, M. and Stiegler, P. (1981). Optimal computer folding of large RNA sequences using thermodynamics and auxiliary information. *Nucleic Acids Res*, 9(1):133–148.

Part VI

Index

Index

- mapping
 - extract from selection, 420
- 3D Molecule Viewer, 283
- 3D molecule view
 - navigate, 288
 - rotate, 288
 - styles, 291
 - zoom, 288
- 3D structure, 285, 286
- AB1, file format, 943
- Abbreviations
 - amino acids, 940
- ABI, file format, 943
- Accession number, display, 71
- .ace, file format, 949
- ACE, file format, 944
- Actions Drugdiscovery, 297
- Adapter trimmimg, 547
- Add
 - annotations, 246
 - sequences to alignment, 479
 - sequences to contig, 414
 - Structure Prediction Constraints, 522
- Adjust selection, 238
- Adjust trim, 415
- Advanced preferences, 109
- Advanced RNA options
 - Apply base pairing constraints, 522
 - Avoid isolated base pairs, 522, 533
 - Coaxial stacking, 522, 533
 - GAIL rule, 522, 533
- Advanced search, 102
- Affymetrix arrays, 955
- Affymetrix NetAffx, file format, 945
- Affymetrix, file format, 945
- Affymetrix, supported file formats, 958
- Algorithm
 - alignment, 467
- Align
 - alignments, 470
- Alignment, see Alignments
- Alignment Primers
 - Degenerate primers, 390, 391
 - PCR primers, 389
 - Primers with mismatches, 390, 391
 - Primers with perfect match, 390, 391
 - TaqMan Probes, 390
- Alignment-based primer design, 388
- Alignments, 467
 - add sequences to, 479
 - compare, 482
 - create, 468
 - design primers for, 388
 - edit, 477
 - fast algorithm, 469
 - join, 480
 - multiple, Bioinformatics explained, 485
 - remove sequences from, 479
 - view, 473
 - view annotations on, 242
- Aliphatic index, 328
- .aln, file format, 949
- Alphabetical sorting of folders, 69
- Ambiguities, reverse translation, 366
- Amino acid composition, 330
- Amino acids
 - abbreviations, 940
 - UIPAC codes, 940
- Analyze primer properties, 394
- Annotation
 - select, 238
- Annotation Layout, in Side Panel, 242
- Annotation level, 832
- Annotation tests, 882
 - Gene set enrichment analysis (GSEA), 885
 - GSEA, 885
 - Hypergeometric test, 882
- Annotation types
 - define your own, 246
- Annotation Types, in Side Panel, 242
- Annotations

- add, 246
- add to experiment, 834
- copy to other sequences, 478
- edit, 246, 248
- expression analysis, 834
- extract, 308
- in alignments, 478
- introduction to, 241
- links, 184
- overview of, 244
- show/hide, 242
- table of, 244
- trim, 406
- types of, 242
- view on sequence, 242
- viewing, 242
- Annotations, add links to, 248
- Antigenicity, 351
- Append wildcard, search, 170, 174, 177
- Arrange
 - views in View Area, 50
- Array data formats, 955
- Array platforms, 955
- Assemble
 - de novo, 895
 - report, 624
 - sequences, 406
 - to existing contig, 414
 - to reference sequence, 408, 601
- Assembly
 - variance table, 422
- Atomic composition, 330
- attB sites, add, 439
- Attributes, 93
- Audit, 106
- Automation, 198

- Back-up, attribute, 95
- Backup, 157
- BAM format, 146
- BAM, export format specification, 951
- BAM, file format, 944
- Base pairs
 - required for mispriming, 382
- Batch edit element properties, 73
- Batch processing, 189
- Bibliography, 977
- Binding site for primer, 395
- Bioinformatic data
 - export, 150
 - formats, 119, 942
- bl2seq, see Local BLAST
- BLAST
 - against a local Database, 260
 - against NCBI, 256
 - contig, 420
 - create database from file system, 272
 - create database from Navigation Area, 272
 - create local database, 272
 - database management, 272
 - graphics output, 266
 - hit table output, 269
 - list of databases, 932
 - parameters, 258, 262
 - search, 256
 - sequencing data, assembled, 420
 - specify server URL, 110
 - table output, 267
 - URL, 110
- BLAST database index, 272
- BLAST DNA sequence
 - BLASTn, 257, 260
 - BLASTx, 257, 260
 - tBLASTx, 257, 260
- BLAST Protein sequence
 - BLASTp, 258, 261
 - tBLASTn, 258, 261
- BLAST result
 - search in, 269
- BLAST search
 - Bioinformatics explained, 274
- BLAST search, Protein Data Bank, 286
- BLOSUM, scoring matrices, 319
- Bootstrap tests, 502
- Borrow network license, 31
- Box plot, 850
- BP reaction, Gateway cloning, 444
- Broken pair coloring, 418, 622
- Broken pairs, find mates, 622
- Browser, import sequence from, 120
- Bug reporting, 16

- C/G content, 234
- CAS, file format, 944
- CASAVA1.8, paired data, 132
- CDS, translate to protein, 238
- Chain flexibility, 235
- Cheap end gaps, 469

- ChIP-Seq analysis, 918, 921
- ChIP-Seq Quality Control, 919
- Chromatogram traces
 - scale, 402
- .cif, file format, 949
- Circular view of sequence, 239
- .clc, file format, 157, 949
- CLC Standard Settings, 113
- CLC, file format, 943–945, 949
 - associating with *CLC Genomics Workbench*, 18
- Cleavage, 367
 - the Peptidase Database, 370
- Clone Manager, file format, 943
- Cloning, 427
 - insert fragment, 436
- Close view, 48
- Clustal, file format, 945
- Cluster linkage
 - Average linkage, 855
 - Complete linkage, 855
 - Single linkage, 855
- Coding sequence, translate to protein, 238
- Codon
 - frequency tables, reverse translation, 365
 - usage, 366
- .col, file format, 949
- Color residues, 474
- Combine RNA-Seq Report, 780
- Comments, 250
- Common name
 - batch edit, 73
- Compatible ends, 454
- Complete Genomics data, 144
- Complexity plot, 323
- Configure network, 39
- Conflicting enzymes, 459
- Conflicts, overview in assembly, 422
- Consensus sequence, 473
 - extract, 618
 - open, 473, 618
- Consensus sequence, extract, 420, 648
- Conservation, 473
- Contact information, 16
- Contig
 - ambiguities, 422
 - BLAST, 420
 - create, 406
 - reverse complement, 416
 - view and edit, 415
- Contigs
 - map reads, 915
- Copy, 165
 - annotations in alignments, 478
 - elements in Navigation Area, 70
 - into sequence, 239
 - search results, GenBank, 172
 - search results, structure search, 175
 - search results, UniProt, 179
 - sequence, 251
 - sequence selection, 343
 - text selection, 251
- Cores, maximum limit, 20
- Cores, using multiple, 927
- Count
 - small RNAs, 807
- Coverage, definition of, 628
 - .cpf, file format, 110
 - .chp, file format, 949
- CPU cores, maximum limit, 20
- CPU usage and multiple cores, 927
- Create
 - alignment, 468
 - dot plots, 314
 - enzyme list, 463
 - local BLAST database, 272
 - new folder, 69
 - workspace, 61
- Create a workflow, 199
- Create index file, BLAST database, 272
- Create tree, 491
- Create Trees, 489
- csfasta, file format, 137
- CSV
 - export graph data points, 163
 - formatting of decimal numbers, 154
 - .csv, file format, 949
- CSV, file format, 945, 946, 949
 - .ct, file format, 949
- Custom annotation types, 246
- Custom fields, 93
- Customizing visualization, 3D structure, 290
- Dark, color of broken pairs, 418, 622
- Data
 - storage location, 68
- Data formats

- bioinformatic, 942
- graphics, 950
- Data preferences, 109
- Data sharing, 68
- Data structure, 66
- Database
 - GenBank, 170
 - local, 66
 - NCBI, 271
 - nucleotide, 932
 - peptide, 932
 - shared BLAST database, 270, 271
 - structure, 173
 - UniProt, 176
- Db source, 250
- db_xref references, 184
- De novo, assembly, 895
- de-multiplexing, 557
- Delete
 - element, 72
 - residues and gaps in alignment, 477
 - workspace, 61
- Description, 250
 - batch edit, 73
- Dipeptide distribution, 330
- Discovery studio
 - file format, 943
- Distance based reconstruction methods
 - neighbor joining, 501
 - UPGMA, 501
- Distance measure, 854
- Distance, pairwise comparison of sequences in alignments, 484
- DNA translation, 344
- DNASTrider, file format, 943
- Dot plots
 - Bioinformatics explained, 316
 - create, 314
 - print, 316
- Double cutters, 449
- Double stranded DNA, 231
- Download 3D Protein Structure Database, 750
- Download and open
 - search results, GenBank, 172, 175
 - search results, UniProt, 178
- Download and save
 - search results, GenBank, 172, 175
 - search results, UniProt, 178
- Download of *CLC Genomics Workbench*, 17
- Download, 3D Protein Structure Database, 750
- Drag and drop
 - folder editor, 74
 - Navigation Area, 70
 - search results, GenBank, 172, 175
 - search results, UniProt, 178
- DS Gene
 - file format, 943
- Dual screen support, 52
- E-PCR, 395
- Edit
 - alignments, 477
 - annotations, 246, 248
 - enzymes, 450
 - sequence, 238
 - single bases, 239
- Element
 - delete, 72
 - rename, 72
 - .embl, file format, 949
- Embl, file format, 943
- Encapsulated PostScript, export, 161
- End gap cost, 469
- End gap costs
 - cheap end caps, 469
 - free end gaps, 469
- Entry clone, creating, 444
- Enzyme list, 463
 - create, 463
 - edit, 465
 - view, 465
 - .eps-format, export, 161
- Error reports, 16
- Example data, import, 37
- Excel 2007, file format, 946
- Excel 2010, file format, 946
- Excel, export file format, 949
- Expand selection, 238
- Expect, BLAST search, 266
- Experiment
 - set up, 825
- Experiment**, 825
- Export
 - bioinformatic data, 150
 - dependent objects, 155
 - folder, 155
 - graph in csv format, 163

- graphics, 159
- history, 156
- list of formats, 942
- mapping coverage, 944
- preferences, 110
- Side Panel Settings, 108
- table, 158
- tables, 945, 949
- Export visible area, 160
- Export whole view, 160
- Expression analysis, 757
- Expression browser, 798
- Expression clone, creating, 445
- Expression data
 - annotation files, 955
- Extensions, 37
- External files, import and export, 121
- Extinction coefficient, 329
- Extract
 - Consensus sequence, 648
 - part of a mapping, 420
- Extract and count small RNAs, 807
- Extract consensus sequences, from mapping
 - table, 618
- Extract sequences, 310
- FASTA, file format, 943
- fasta, file format, 136
- FASTQ, file format, 131, 943
- fastq, file format, 136
- Favorite tools, 60
- Feature clustering, 874
 - K-means clustering, 879
 - K-medoids clustering, 879
- Feature request, 16
- Feature table, 330
- Feature, for expression analysis, 825
- Features, see Annotations
- File name, sort sequences based on, 411
- File system, local BLAST database, 272
- Filtering restriction enzymes, 450, 452, 455, 464
- Find
 - in GenBank file, 251
 - in sequence, 236
 - results from a finished process, 57
- Find open reading frames, 346
- Find, in tracks, 580
- Fit to pages, print, 116
- Fixpoints, for alignments, 471
- Folder editor
 - drag and drop, 74
- Follow selection, 231
- Footer, 117
- FormatDB, 272
- Fragment table, 459
- Fragment, select, 238
- Fragments, separate on gel, 461
- Free end gaps, 469
- Freezer position, 93
- Frequently used tools, 60
 - .fsa, file format, 949
- G/C content, 234
- G/C restrictions
 - 3' end of primer, 377
 - 5' end of primer, 377
 - End length, 377
 - Max G/C, 377
- Gap
 - compare number of, 484
 - delete, 477
 - extension cost, 469
 - fraction, 474
 - insert, 477
 - open cost, 469
- Gateway cloning
 - add attB sites, 439
 - create entry clones, 444
 - create expression clones, 445
- Gb Division, 250
 - .gbk, file format, 949
- GC content, 376
- GCG Alignment, file format, 945
- GCG Sequence, file format, 943
 - .gck, file format, 949
- GCK, Gene Construction Kit file format, 943
- Gel
 - separate sequences without restriction enzyme digestion, 461
 - tabular view of fragments, 459
- Gel electrophoresis, 460
 - marker, 462
 - view, 461
 - view preferences, 461
 - when finding restriction sites, 458
- GenBank
 - view sequence in, 251

- file format, 943
- search, 170
- search sequence in, 184
- Gene Construction Kit, file format, 943
- Gene expression, 757, 787
- Gene finding, 346
- Gene Set Test, 803
- General preferences, 105
- General Sequence Analyses, 308
- Genetic code, reverse translation, 365
- Genome browser, 576
- GEO, file format, 945
- GFF, 122
- .gff, file format, 949
- GO, import annotation file, 961
- Google sequence, 184
- GOstats, see Hypergeometric tests on annotations
- Graph
 - export data points in csv format, 163
- Graph Side Panel, 930
- Graphics
 - data formats, 950
 - export, 159
- Groups, define, 825
- .gzip, file format, 949
- Gzip, file format, 949
- H5, file format, 136
- Half-life, 328
- Header, 117
- Heat map, 793
 - clustering of features, 796, 877
 - clustering of samples, 856
- Help, 36
- Heterozygotes, discover via secondary peaks, 425
- Hide/show Toolbox, 57
- Hierarchical clustering
 - of features, 875
 - of samples, 854
- Histogram, 888
 - Distributions, 888
- History
 - export, 156
- Homology, pairwise comparison of sequences
 - in alignments, 484
- Hotelling observer, 920
- Hydrophobicity, 353
- Bioinformatics explained, 355
- Chain Flexibility, 357
- Cornette, 235, 356
- Eisenberg, 235, 356
- Emini, 235
- Engelman (GES), 235, 356
- Hopp-Woods, 235, 356
- Janin, 235, 356
- Karplus and Schulz, 235
- Kolaskar-Tongaonkar, 235, 356
- Kyte-Doolittle, 235, 355
- Rose, 356
- Surface Probability, 356
- Welling, 235, 356
- Hypergeometric tests on annotations, 882
- ID, license, 24
- Import
 - bioinformatic data, 119, 120
 - from a web page, 120
 - High-throughput sequencing data, 128
 - list of formats, 942
 - Next-Generation Sequencing data, 128
 - NGS data, 128
 - preferences, 110
 - raw sequence, 120
 - RNA spike-in controls, 149
 - Side Panel Settings, 108
 - using copy paste, 120
- Import issues, 287
- Import Metadata, 75
- Import protein structure, BLAST, 286
- Import protein structure, from file, 285
- Import protein structure, Protein Data Bank, 285
- Improvements, 41
- In silico PCR, 395
- Index for searching, 104
- Information point, primer design, 374
- Insert
 - gaps, 477
- Insert restriction site, 438
- Inspecting results, 923
- Installation, 17
- Invert sequence, 343
- Isoelectric point, 328
- Isoschizomers, 454
- IUPAC codes
 - nucleotides, 941

- Join
 - alignments, 480
 - sequences, 331
 - .jpg-format, export, 161
- K-means clustering, 879
- K-medoids clustering, 879
- K-mer based distance estimation, 500
- K-mer Based Tree Construction, 489
- Keywords, 250
- Label
 - of sequence, 231
- Landscape, Print orientation, 116
- Lasergene sequence
 - file format, 943
- Latin name
 - batch edit, 73
- Length, 250
- License, 21
 - ID, 24
 - non-networked machine, 34
 - starting without a license, 35
- License server, 30
- License server: access offline, 31
- Limited mode, 35
- Link Variants to 3D Protein Structure, 737
- Linker trimming, 547
- Links, from annotations, 248
- Linux
 - installation, 18
- List of restriction enzymes, 463
- List of sequences, 251
- Load enzyme list, 450
- Local BLAST, 260
- Local BLAST Database, 272
- Local BLAST database management, 272
- Local BLAST Databases, 270
- Local complexity plot, 323
- Local Database, BLAST, 260
- Locale setting, 106
- Location
 - search in, 102
 - path to, 68
- Logo, sequence, 474
- LR reaction, Gateway cloning, 445
- MA plot, 891
 - .ma4, file format, 949
- Mac OS X installation, 18
- Manage BLAST databases, 272
- Manual editing, auditing, 106
- Manual format, 41
- Map
 - to coding regions, 602
- Map reads to reference
 - select reference sequences, 602
- Map reads to reference
 - masking, 602
- Map reads, contigs, 915
- Mapping
 - report, 626
- Mapping reads to a reference sequence, 601
- Mapping table, 618
- Mappings
 - merge, 644
- Marker, in gel view, 462
- Mask, reference sequence, 602
- Match weight, 823
- Mates, locate from broken pairs, 622
- Maximize size of view, 51
- Maximum Likelihood Phylogeny, 494
- Maximum likelihood reconstruction methods, 501
- Melting temperature
 - DMSO concentration, 376
 - dNTP concentration, 376
 - Magnesium concentration, 376
- Melting temperature, 376
 - Cation concentration, 376, 395
 - Cation concentration, 396
 - Inner, 376
 - Primer concentration, 395
 - Primer concentration, 396
 - Primerconcentration, 376
- Menu Bar, illustration, 44
- Merge mapping results, 644
- Metadata, 74
- Metadata - partial matching rules, 85
- Metadata association, 82
- Metadata import, 75
- Microarray data formats, 955
- Microarray platforms, 955
- microRNA analysis, 807
- Mixed data, 644
- Model testing, 492
- Modification date, 250

- Modify enzyme list, 465
- Modules, 37
- Molecular weight, 328
- Monitors, supporting multiple monitors, 52
- Motif list, 339
- Motif search, 334, 339
- Mouse modes, 54
- Move
 - elements in Navigation Area, 70
 - sequence to top, 478
 - sequences in alignment, 478
- .msf, file format, 949
- Multi-group experiment, 826
- Multiple alignments, 485
- Multiple testing
 - Benjamini-Hochberg corrected p-values, 871
 - Benjamini-Hochberg FDR, 871
 - Bonferroni, 871
 - Correction of p-values, 871
 - FDR, 871
- Multiplexing, 557
 - by name, 411
- Multiselecting, 69
- N50, 626
- Name, 250
- Navigate, 3D structure, 288
- Navigation Area, 66
 - create local BLAST database, 272
 - illustration, 44
- NCBI, 170
 - search for structures, 173
 - search sequence in, 184
- NCBI BLAST
 - add more databases, 933
- Negatively charged residues, 330
- Neighbor joining, 501
- NetAffx annotation files, 960
- Network configuration, 39
- Network drive, shared BLAST database, 270, 271
- Network license, 30
- Network license: use offline, 31
- Never show this dialog again, 106
- New
 - feature request, 16
 - folder, 69
- New sequence
 - create from a selection, 238
- Newick, file format, 945
- .nexus, file format, 949
- Nexus, file format, 943, 945
- .nhr, file format, 949
- Non-coding RNA analysis, 807
- Non-specific matches, 607
- Non-standard residues, 232
- Normalization, 847
 - Quantile normalization, 847
 - Scaling, 847
- Nucleotide
 - info, 233
 - sequence databases, 932
- Nucleotides
 - UIPAC codes, 941
- Numbers on sequence, 231
- .nwk, file format, 949
- .nxs, file format, 949
- .oa4, file format, 949
- Open
 - consensus sequence, 473
 - from clipboard, 120
- Open reading frame determination, 346
- Open-ended sequence, 347
- Order primers, 399
- ORF, 346
- Organism, 250
- Overhang
 - of fragments from restriction digest, 459
- Overhang, find restriction enzymes based on, 450, 452, 455, 464
- Overlapping paired reads, 622
 - .pa4, file format, 949
- Page heading, 117
- Page number, 117
- Page setup, 116
- Paired data, 140, 142, 145
- Paired reads
 - combined with single reads, 644
 - overlapping, 622
- Paired samples, expression analysis, 826
- Paired status, 146
- Pairwise comparison, 482
- PAM, scoring matrices, 319
- Parallelization, 927
- Parameters
 - search, 170, 174, 177

- Partition function, 521
- Partitioning around medoids (PAM), see K-medoids clustering
- Paste
 - text to create a new sequence, 120
- Paste/copy, 165
- Pattern Discovery, 332
- Pattern Search, 334
- PCA, 858
- PCR, perform virtually, 395
 - .pdb, file format, 284, 949
 - .seq, file format, 949
- PDB, file format, 949
 - .pdf-format, export, 161
- Peak shape, 920
- Peak shape score, 921
- Peak, call secondary, 425
- Peptidase, 367
- Peptide sequence databases, 932
- Percent identity, pairwise comparison of sequences in alignments, 484
- Personal information, 16
- Pfam domain search, 357
 - .phr, file format, 949
- Phred, file format, 943
 - .phy, file format, 949
- Phylip, file format, 945
- Phylogenetic tree, 491
- Phylogenetic tree methods, 497
- Phylogenetic trees
 - add or modify metadata, 514
 - background settings, 507
 - bootstrap settings, 509
 - bootstrap tests, 502
 - branch layout, 507
 - create tree, 491
 - create trees, 489
 - features, 487
 - K-mer based distance estimation, 500
 - K-mer based tree construction, 489
 - label settings, 506
 - maximum likelihood phylogeny, 494
 - maximum likelihood reconstruction methods, 501
 - metadata, 510, 512
 - minimap, 504
 - model testing, 492
 - neighbor joining, 501
 - node right click menu, 510
 - node settings, 505
 - selection of nodes, 516
 - substitution models and distance estimation, 498
 - table settings and filtering, 513
 - tree layout, 504
 - tree settings, 503
 - UPGMA, 501
- Pipeline, 198
 - .pir, file format, 949
- PIR (NBRF), file format, 943
- Plot
 - dot plot, 314
 - local complexity, 323
- Plugins, 37
 - .png-format, export, 161
- Polarity colors, 233
- Portrait, Print orientation, 116
- Positively charged residues, 330
- PostScript, export, 161
- Preference group, 111
- Preferences, 105
 - advanced, 109
 - Data, 109
 - export, 110
 - General, 105
 - import, 110
 - style sheet, 111
 - View, 106
 - view, 53
- Primer, 395
 - analyze, 394
 - based on alignments, 388
 - Buffer properties, 376
 - display graphically, 378
 - length, 376
 - mode, 377, 378
 - nested PCR, 377
 - order, 399
 - sequencing, 377
 - standard, 377
 - TaqMan, 377
- Primers
 - find binding sites, 395
- Principal component analysis, 858
 - Scree plot, 861
- Print, 114

- dot plots, 316
- preview, 117
- visible area, 115
- whole view, 115
- .pro, file format, 949
- Problems when starting up, 35
- Processes, 57
- Properties, batch edit, 73
- Protease, cleavage, 367
- Protein
 - charge, 350
 - cleavage, 367
 - hydrophobicity, 355
 - Isoelectric point, 328
 - report, 361
 - report, output, 363
 - signal peptide, 350
 - statistics, 328
 - structure prediction, 360
 - translation, 363
- Protein Data Bank, 285
- Proteolytic cleavage, 367
 - Bioinformatics explained, 369
- Proteolytic enzymes cleavage patterns, 935
- Proxy server, 39
 - .ps-format, export, 161
 - .psi, file format, 949
- PubMed references, search, 184

- QC, 849
- QSEQ, file format, 131
- Quality control
 - MA plot, 891
- Quality of chromatogram trace, 402
- Quality of trace, 404, 547
- Quality score of trace, 404, 547
- Quality scores, 234
- Quick start, 36

- Rasmol colors, 233
- Read mapping, 601
- Reading frame, 346
- Reassemble contig, 424
- Rebase, restriction enzyme database, 463
- Rebuild index, 104
- Recognition sequence
 - insert, 438
- Recover removed attribute, 95
- Recycle Bin, 72

- Redo alignment, 470
- Redo/Undo, 49
- Reference assembly, 601
- References, 977
- Region
 - types, 239
- Remove
 - annotations, 249
 - sequences from alignment, 479
 - terminated processes, 58
- Rename element, 72
- Repeat masking, 602
- Report
 - of assembly, 624
- Report program errors, 16
- Request new feature, 16
- Resequencing analysis tools
 - Identify Known Mutations from Sample Mappings, 750
- Residue coloring, 232
- Restore
 - deleted elements, 72
 - size of view, 51
- Restriction enzymes
 - filter, 450, 452, 455, 464
 - from certain suppliers, 450, 452, 455, 464
- Restriction enzyme list, 463
- Restriction enzyme, star activity, 463
- Restriction enzymes, 447
 - compatible ends, 454
 - cutting selection, 451
 - isoschizomers, 454
 - methylation, 450, 452, 455, 464
 - number of cut sites, 449
 - overhang, 450, 452, 455, 464
 - separate on gel, 461
 - sorting, 449
- Restriction sites, 447
 - enzyme database Rebase, 463
 - select fragment, 238
 - number of, 456
 - on sequence, 232, 447
 - parameters, 454
- Reverse complement, 343
- Reverse complement mapping, 416
- Reverse sequence, 343
- Reverse translation, 363
 - Bioinformatics explained, 365

- Right-click on Mac, [41](#)
- RNA structure
 - partition function, [521](#)
- RNA structure prediction by minimum free energy minimization
 - Bioinformatics explained, [537](#)
- RNA translation, [344](#)
- RNA-Seq analysis, [757](#)
- .rnaml, file format, [949](#)
- Rotate, 3D structure, [288](#)
- RPKM, definition, [767](#)

- Safe mode, [35](#)
- SAM format, [146](#)
- SAM, export format specification, [951](#)
- SAM, file format, [944](#)
- Sample, for expression analysis, [825](#)
- Save
 - changes in a view, [49](#)
 - style sheet, [111](#)
 - view preferences, [111](#)
 - workspace, [60](#)
- Save enzyme list, [450](#)
- Scale bar, [503](#)
- Scale traces, [402](#)
- SCARF, file format, [131](#)
- Scatter plot, [894](#)
- SCF2, file format, [943](#)
- SCF3, file format, [943](#)
- Score, BLAST search, [266](#)
- Scoring matrices
 - Bioinformatics explained, [319](#)
 - BLOSUM, [319](#)
 - PAM, [319](#)
- Scree plot, [861](#)
- Screen, multiple screen support, [52](#)
- Scripting, [198](#)
- Scroll wheel
 - to zoom in, [55](#)
 - to zoom out, [55](#)
- Search, [102](#)
 - in one location, [102](#)
 - BLAST, [256](#)
 - for structures at NCBI, [173](#)
 - GenBank, [170](#)
 - GenBank file, [251](#)
 - handle results from GenBank, [171](#)
 - handle results from NCBI structure DB, [174](#)
 - handle results from UniProt, [178](#)
 - hits, number of, [106](#)
 - in a sequence, [236](#)
 - in annotations, [236](#)
 - in Navigation Area, [99](#)
 - Local BLAST, [260](#)
 - options, GenBank, [170](#)
 - options, GenBank structure search, [174](#)
 - options, SRA, [180](#)
 - options, UniProt, [176](#)
 - own motifs, [339](#)
 - parameters, [170](#), [174](#), [177](#)
 - patterns, [332](#), [334](#)
 - Pfam domains, [357](#)
 - PubMed references, [184](#)
 - sequence in UniProt, [184](#)
 - sequence on Google, [184](#)
 - sequence on NCBI, [184](#)
 - sequence on web, [183](#)
 - TrEMBL, [176](#)
 - troubleshooting, [104](#)
 - UniProt, [176](#)
- Search, in tracks, [580](#)
- Secondary peak calling, [425](#)
- Secondary structure prediction, [360](#)
- Secondary structure, for primers, [377](#)
- Select
 - exact positions, [236](#)
 - in sequence, [237](#)
 - parts of a sequence, [237](#)
 - workspace, [61](#)
- Select annotation, [238](#)
- Selection mode in the toolbar, [56](#)
- Selection, adjust, [238](#)
- Selection, expand, [238](#)
- Self annealing, [377](#)
- Self end annealing, [377](#)
- Separate sequences on gel, [461](#)
 - using restriction enzymes, [461](#)
- Sequence
 - alignment, [467](#)
 - analysis, [308](#)
 - display different information, [71](#)
 - extract from sequence list, [310](#)
 - find, [236](#)
 - information, [250](#)
 - join, [331](#)
 - layout, [231](#)
 - lists, [251](#)

- logo Bioinformatics explained, 475
 - region types, 239
 - search, 236
 - select, 237
 - shuffle, 312
 - statistics, 324
 - view, 230
 - view as text, 251
 - view circular, 239
 - view format, 71
 - web info, 183
- Sequence comma separated values, file format, 943
- Sequence logo, 474
- Share data, 68
- Share Side Panel Settings, 108
- Shared BLAST database, 270, 271
- Shortcuts, 62
- Show
 - enzymes cutting selection, 451
 - results from a finished process, 57
- Show dialogs, 106
- Show enzymes with compatible ends, 454
- Show/hide Toolbox, 57
- Shuffle sequence, 312
- Side Panel Settings
 - export, 108
 - import, 108
 - share with others, 108
- Signal peptide, 350
- SignalP, 350
- Single base editing
 - in mapping, 419
 - in sequences, 239
- Single cutters, 449
- Small RNA analysis, 807
- Small RNAs
 - extract and count, 807
 - trim, 807
- Snippets, 215
- Sort
 - sequences alphabetically, 478
 - sequences by similarity, 478
- Sort sequences by name, 411
- Sort, folders, 69
- Species, display name, 71
- SRA, 179
- Staden, file format, 943
- Standard Settings, CLC, 113
- Star activity, 463
- Start Codon, 347
- Start-up problems, 35
- Statistical analysis, 863
 - ANOVA, 863
 - Corrected of p-values, 871
 - Paired t-test, 863
 - Repeated measures ANOVA, 863
 - t-test, 863
 - Volcano plot, 872
- Statistics
 - protein, 328
 - sequence, 324
- Status Bar, 57, 60
 - illustration, 44
- .str, file format, 949
- Structure editor, 288
- Structure, prediction, 360
- Style sheet, preferences, 111
- Subcontig, extract part of a mapping, 420
- Substitution models and distance estimation, 498
- Support, 16
- Surface probability, 235
 - .svg-format, export, 161
- Swiss-Prot, 176
 - search, see UniProt
- Swiss-Prot, file format, 943
 - .swp, file format, 949
- System requirements, 19
- Tab delimited, file format, 945, 949
- Tab, file format, 943
- Table of fragments, 459
- Tabs, use of, 46
- Tags, insert into sequence, 438
 - .tar, file format, 949
- Tar, file format, 949
- Taxonomy
 - batch edit, 73
- tBLASTn, 258, 261
- tBLASTx, 257, 260
- Terminated processes, 58
- Text format, 237
 - view sequence, 251
- Text, file format, 949
 - .tif-format, export, 161
- TMHMM, 351

- Toolbar
 - illustration, 44
- Toolbox, 57, 58
 - illustration, 44
 - show/hide, 57
- Trace colors, 233
- Trace data, 402
 - quality, 404, 547
- Traces
 - scale, 402
- Track list
 - in workflow, 584
- Track Lists, 576
- Tracks, 574
- Transcriptomics, 757, 780, 787
- Transformation, 846
- Translate
 - a selection, 234
 - along DNA sequence, 233
 - annotation to protein, 238
 - CDS, 346
 - coding regions, 346
 - DNA to RNA, 341
 - nucleotide sequence, 344
 - ORF, 346
 - protein, 363
 - RNA to DNA, 342
 - to protein, 344
- Translation
 - of a selection, 234
 - show together with DNA sequence, 233
- Transmembrane helix prediction, 351
- Tree generation, methods, 497
- TrEMBL, search, 176
- Trim, 403, 545
 - small RNAs, 807
- Trimmed regions
 - adjust manually, 415
- TSV, file format, 943
- Two-color arrays, 955
- Two-group experiment, 826
 - .txt, file format, 949
- UIPAC codes
 - amino acids, 940
- Undo limit, 105
- Undo/Redo, 49
- UniProt, 176
 - search, 176
 - search sequence in, 184
- UniVec, trimming, 404, 547
- UPGMA, 501
- Urls, Navigation Area, 121
- User interface, 44
- Variance table, assembly, 422
- Variant
 - detect, 683
- Variant callers, 683
- Variant data, 711
- Variant detection, 683
- Variant tracks, 712
- Variants, Link to 3D Protein Structure, 737
- VCF, 946
- Vector
 - see cloning, 427
- Vector contamination, find automatically, 404, 547
- Vector design, 427
- Vector graphics, export, 161
- Vector NTI import, 121
- VectorNTI
 - file format, 943
- Venn diagram, 800
- View, 45
 - alignment, 473
 - dot plots, 316
 - GenBank format, 251
 - preferences, 53
 - save changes, 49
 - sequence, 230
 - sequence as text, 251
- View Area, 45
 - illustration, 44
- View preferences, 106
 - style sheet, 111
- Visualization styles, 3D structure, 291
- Volcano plot, 792, 872
 - .vsf, file format for settings, 108
- Web page, import sequence from, 120
- Wildcard, append to search, 170, 174, 177
- Windows installation, 17
- Workflow, 198
 - adding elements to existing workflow, 214
 - configure elements, 200
 - connect elements, 203
 - create, 199

- input modifying tools, 211
- layout, 209
- lock and unlock parameters, 202
- reusing elements from workflow, 215
- snippets, 215
- validation, 212
- Workflows - multiple input elements and batch, 192
- Workspace, 60
 - create, 61
 - delete, 61
 - save, 60
 - select, 61
- Wrap sequences, 231
- .xls, file format, 949
- .xlsx, file format, 949
- .xml, file format, 949
- XSQ, file format, 137
- Zip, file format, 949
- Zoom, 54
- Zoom In, 55
- Zoom Out, 55
- Zoom, 3D structure, 288